

**UNITED STATES  
SECURITIES AND EXCHANGE COMMISSION**  
Washington, D.C. 20549

**Amendment No. 3 to  
FORM F-4**

**REGISTRATION STATEMENT  
UNDER  
THE SECURITIES ACT OF 1933**

**YishengBio Co., Ltd**

(Exact name of Registrant as specified in its charter)

**Cayman Islands**  
(State or Other Jurisdiction Of  
Incorporation or Organization)

**2834**  
(Primary Standard Industrial  
Classification Code Number)

**Not Applicable**  
(I.R.S. Employer  
Identification Number)

**Building No. 2, 38 Yongda Road  
Daxing Biomedical Industry Park  
Daxing District, Beijing, PRC  
Tel: +86-10 8920-2086**

(Address, including zip code, and telephone number, including area code, of Registrant's principal executive offices)

**COGENCY GLOBAL INC.  
122 East 42nd Street, 18th Floor,  
New York, NY 10168  
Tel: (212) 947-7200**

(Name, address, including zip code, and telephone number, including area code, of agent for service)

*Copies to:*

**Dan Ouyang, Esq.  
Wilson Sonsini Goodrich & Rosati  
Professional Corporation  
Unit 2901, 29F, Tower C, Beijing Yintai Centre  
No. 2 Jianguomenwai Avenue  
Chaoyang District, Beijing 100022  
The People's Republic of China  
+86-10 6529-8300**

**Will H. Cai, Esq.  
Yiming Liu, Esq.  
Timothy Pitrelli, Esq.  
Cooley LLP  
c/o 35th Floor  
Two Exchange Square  
8 Connaught Place  
Central, Hong Kong  
+852 3758 1200**

**Approximate date of commencement of proposed sale of the securities to the public:**

As soon as practicable after this Registration Statement becomes effective and on completion of the business combination described in the enclosed proxy statement/prospectus.

If this Form is filed to register additional securities for an offering pursuant to Rule 462(b) under the Securities Act, check the following box and list the Securities Act registration statement number of the earlier effective registration statement for the same offering.

If this Form is a post-effective amendment pursuant to Rule 462(d) under the Securities Act, check the following box and list the Securities Act registration statement number of the earlier effective registration for the share offering.

If applicable, place an X in the box to designate the appropriate rule provision relied upon in conducting this transaction:

Exchange Act Rule 13e-4(i) (Cross-Border Issuer Tender Offer)

Exchange Act Rule 14d-1(d) (Cross-Border Third-Party Tender Offer)

Indicate by check mark whether the registrant is an emerging growth company as defined in Rule 405 of the Securities Act of 1933.

Emerging growth company

If an emerging growth company that prepares its financial statements in accordance with U.S. GAAP, indicate by check mark if the registrant has elected not to use the extended transition period for complying with any new or revised financial accounting standards<sup>†</sup> provided pursuant to Section 7(a)(2)(B) of the Securities Act.

<sup>†</sup> The term "new or revised financial accounting standard" refers to any update issued by the Financial Accounting Standards Board to its Accounting Standards Codification after April 5, 2012.

**The registrant hereby amends this registration statement on such date or dates as may be necessary to delay its effective date until the registrant shall file a further amendment which specifically states that this registration statement shall thereafter become effective in accordance with Section 8(a) of the Securities Act of 1933, as amended, or until the registration statement shall become effective on such date as the Securities and Exchange Commission, acting pursuant to said Section 8(a), may determine.**

**PRELIMINARY, SUBJECT TO COMPLETION, DATED FEBRUARY 3, 2023**

**PROXY STATEMENT FOR EXTRAORDINARY GENERAL MEETING OF SHAREHOLDERS OF**



**SUMMIT HEALTHCARE ACQUISITION CORP.**

**AND**

**PROSPECTUS FOR UP TO 30,045,800 ORDINARY SHARES, 16,750,000  
WARRANTS AND 16,750,000 ORDINARY SHARES ISSUABLE UPON EXERCISE  
OF WARRANTS**

**OF**



**YISHENGBIO CO., LTD**

The board of directors of Summit Healthcare Acquisition Corp., an exempted company incorporated under the laws of the Cayman Islands (“Summit”), has unanimously approved the Business Combination Agreement, dated September 29, 2022, by and among Summit, YishengBio Co., Ltd, an exempted company limited by shares incorporated under the laws of the Cayman Islands (to be renamed as YS Biopharma Co., Ltd, herein referred to as “YS Biopharma”), Oceanview Bioscience Acquisition Co., Ltd., an exempted company limited by shares incorporated under the laws of the Cayman Islands and a direct wholly owned subsidiary of YS Biopharma (“Merger Sub I”) and Hudson Biomedical Group Co., Ltd., an exempted company limited by shares incorporated under the laws of the Cayman Islands and a direct wholly owned subsidiary of YS Biopharma (“Merger Sub II,” collectively with Merger Sub I, the “Merger Subs”). The Business Combination Agreement provides for (1) the merger of Merger Sub I with and into Summit (the “First Merger”), with Summit surviving the First Merger as the surviving entity (the “Surviving Entity”) and becoming a wholly-owned subsidiary of YS Biopharma, and (2) the merger of the Surviving Entity with and into Merger Sub II (the “Second Merger,” and together with the First Merger, the “Mergers,” together with other transactions contemplated by the Business Combination Agreement, the “Business Combination”), with Merger Sub II surviving the Second Merger as the surviving company (the “Surviving Company”) and remaining as a wholly-owned subsidiary of YS Biopharma. As a result of and upon consummation of the Business Combination, the holders of shares and/or warrants of Summit will become the holders of shares and/or warrants of YS Biopharma. The respective time at which the First Merger and the Second Merger becomes effective is referred to as the “First Merger Effective Time” and “Second Merger Effective Time,” respectively. The consummation of the Mergers is herein referred to as the “Closing.”

Subject to, and in accordance with the terms and conditions set forth in the Business Combination Agreement, immediately prior to the First Merger Effective Time, (1) each preferred share of YS Biopharma with par value of \$0.000005 will be converted into one ordinary share of YS Biopharma with par value of \$0.000005 each; (the “Pre Consolidation YS Biopharma Ordinary Shares”) (2) after the conversion of all preferred shares into ordinary shares, every four ordinary shares of YS Biopharma with par value of \$0.000005 each will be consolidated into one ordinary share of YS Biopharma with par value of \$0.00002 each (“YS Biopharma Ordinary Share”) and each four of the options of YS Biopharma will be consolidated into one option of YS Biopharma, subject to rounding up to the nearest whole number of shares or options; and (3) the amended and restated memorandum and articles of association of YS Biopharma shall be adopted and become effective. Items (1) through (3) are herein collectively referred to as the “YS Biopharma Capital Restructuring.”

Subject to, and in accordance with the terms and conditions set forth in the Business Combination Agreement, following completion of the YS Biopharma Capital Restructuring and immediately prior to the First Merger Effective Time, (1) each of Summit’s units (“Units”) (each consisting of one Class A ordinary share of Summit, par value \$0.0001 per share (“Summit Class A Ordinary Share”) and one-half of one redeemable warrant of Summit (“Summit Warrant”)) issued and outstanding immediately prior to the First Merger Effective Time shall be automatically detached and the holder thereof shall be deemed to hold one Summit Class A Ordinary Share and one-half of one Summit Warrant (the “Unit Separation”); (2) each Summit Class A Ordinary Share (including Summit Class A Ordinary Shares held by Summit’s

The information in this preliminary proxy statement/prospectus is not complete and may be changed. We may not issue these securities until the registration statement filed with the Securities and Exchange Commission is effective. This preliminary proxy statement/prospectus is not an offer to sell these securities and it is not soliciting an offer to buy these securities in any state where the offer or sale is not permitted.

The information in this preliminary proxy statement/prospectus is not complete and may be changed. We may not issue these securities until the registration statement filed with the Securities and Exchange Commission is effective. This preliminary proxy statement/prospectus is not an offer to sell these securities and it is not soliciting an offer to buy these securities in any state where the offer or sale is not permitted.

public shareholders (“Summit Public Shareholders”) as a result of the Unit Separation and Summit Class A Ordinary Shares to be issued pursuant to the Forward Purchase Subscriptions (as defined in the Business Combination Agreement), but excluding any treasury Summit Shares, redeeming Summit Shares and dissenting Summit Shares) issued and outstanding immediately prior to the First Merger Effective Time shall automatically be cancelled and cease to exist, in exchange for the right to receive such fraction of newly issued YS Biopharma Ordinary Shares that is equal to the Summit Class A Exchange Ratio, without interest; (3) an aggregate of 1,446,525 Class B ordinary shares of Summit, par value \$0.0001 per share (“Summit Class B Ordinary Shares,” together with Summit Class A Ordinary Shares, “Summit Shares”) held by Summit Healthcare Acquisition Sponsor LLC, a Cayman Islands limited liability company (“Sponsor”) will be surrendered for nil consideration, and after such surrender, each of the remaining Summit Class B Ordinary Shares held by Sponsor and the independent directors of Summit issued and outstanding immediately prior to the First Merger Effective Time shall automatically be cancelled and cease to exist, in exchange for the right to receive one newly issued YS Biopharma Ordinary Share; (4) each Summit Class B Ordinary Share held by a Forward Purchase Investor (as defined below) and its permitted transferees issued and outstanding immediately prior to the First Merger Effective Time shall automatically be cancelled and cease to exist, in exchange for the right to receive (a) such fraction of newly issued YS Biopharma Ordinary Shares that is equal to the Summit Class A Exchange Ratio, without interest, if and only if such Forward Purchase Investor has fully delivered its portion of the Forward Purchase Investment Amount (as defined in the Business Combination Agreement) as required under the applicable Forward Purchase Agreement (as defined below) and, failing that, (b) one newly issued YS Biopharma Ordinary Share; and (5) each whole Summit Warrant outstanding immediately prior to the First Merger Effective Time shall cease to be a warrant with respect to Summit Class A Ordinary Shares, and be assumed by YS Biopharma and converted into a warrant (“YS Biopharma Warrants”) to purchase one YS Biopharma Ordinary Share, subject to substantially the same terms and conditions prior to the First Merger Effective Time. No fractional shares or warrants will be issued in the foregoing process, and all such shares or warrants would be rounded down to the nearest whole number of shares or warrants.

In addition, upon the consummation of the First Merger, (1) if there are any Summit Shares that are owned by Summit as treasury shares or any Summit Shares owned by any direct or indirect subsidiary of Summit immediately prior to the First Merger Effective Time, such Summit Shares shall be canceled and shall cease to exist without any conversion thereof or payment or other consideration therefor; (2) each redeeming Summit Share issued and outstanding immediately prior to the First Merger Effective Time shall be cancelled and cease to exist and shall thereafter represent only the right to be paid a pro rata share of the aggregate amount payable with respect to all redeeming Summit Shares (the “Summit Shareholder Redemption Amount”) in accordance with Summit’s amended and restated memorandum and articles of association; and (3) each dissenting Summit Share issued and outstanding immediately prior to the First Merger Effective Time held by a dissenting shareholder of Summit shall be cancelled and cease to exist and shall thereafter represent only the right to be paid the fair value of such dissenting Summit Share and such other rights pursuant to Section 238 of the Cayman Islands Companies Act.

Pursuant to the Business Combination Agreement, (i) each ordinary share, par value \$0.0001 per share, of Merger Sub I that is issued and outstanding immediately prior to the First Merger Effective Time shall automatically convert into one ordinary share, par value \$0.0001 per share, of the Surviving Entity, (ii) each ordinary share of the Surviving Entity that is issued and outstanding immediately prior to the Second Merger Effective Time will be automatically cancelled and extinguished without any conversion thereof or payment therefor and (iii) each ordinary share of Merger Sub II issued and outstanding immediately prior to the Second Merger Effective Time shall remain outstanding and shall not be affected by the Second Merger.

In addition, prior to Summit’s initial public offering (the “IPO”), Summit entered into forward purchase agreements (collectively, the “Forward Purchase Agreements”) with each of Snow Lake Capital (HK) Limited and the Valliance Fund (collectively, the “Forward Purchase Investors”). The Forward Purchase Agreements provide for (i) the transfer of an aggregate of 375,000 Founder Shares from the Sponsor to the Forward Purchase Investors for nil cash consideration prior to the IPO and (ii) the purchase by the Forward Purchase Investors of an aggregate of 3,000,000 Summit Class A Ordinary Shares, plus an aggregate of 750,000 redeemable warrants to purchase Summit Class A Ordinary Shares at \$11.50 per share, for an aggregate purchase price of \$30,000,000 in a private placement to close concurrently with the closing of Summit’s initial business combination, which will be the consummation of the Business Combination. The Forward Purchase Investors’ subscription obligations under the Forward Purchase Agreements do not depend on whether any Summit Class A Ordinary Shares are redeemed by Summit’s public shareholders. Proceeds received from the Forward Purchase Investors under the Forward Purchase Agreements will count towards the Available Closing Cash Amount (as defined in the Business Combination Agreement), which is required to be not less than \$30,000,000 under the Business Combination Agreement. The Forward Purchase Investors have also agreed to vote all Summit Shares held by them in favor of Summit’s initial business combination if Summit seeks shareholder approval of such transaction.

Prior to the First Merger Effective Time, YS Biopharma will be renamed as YS Biopharma Co., Ltd.

Holders of Summit Shares are being asked to consider a vote upon the Business Combination and certain proposals related thereto as described in this proxy statement/prospectus. As a result of, and upon consummation of, the Business Combination, YS Biopharma shall become a public company owned by the current shareholders of YS Biopharma and the non-redeeming shareholders of Summit. **Proposals to approve the Business Combination Agreement and the other matters discussed in this proxy statement/prospectus shall be presented at the Extraordinary General Meeting of holders of Summit Shares scheduled to be held on March 1, at 9:00 a.m., Eastern Time on, at 35th Floor, Two Exchange Square, 8 Connaught Place Central, Hong Kong and over the Internet by means of a live audio webcast.**

The information in this preliminary proxy statement/prospectus is not complete and may be changed. We may not issue these securities until the registration statement filed with the Securities and Exchange Commission is effective. This preliminary proxy statement/prospectus is not an offer to sell these securities and it is not soliciting an offer to buy these securities in any state where the offer or sale is not permitted.

Although YS Biopharma is not currently a public reporting company, following the effectiveness of the registration statement of which this proxy statement/prospectus is a part and the Closing, YS Biopharma will become subject to the reporting requirements of the Securities Exchange Act of 1934, as amended (the “Exchange Act”). YS Biopharma has applied for listing of the YS Biopharma Ordinary Shares and YS Biopharma Warrants on the Nasdaq Stock Market LLC (the “Nasdaq”) under the symbol “YS” and “YSBPW.” It is a condition precedent to the Closing that the YS Biopharma Ordinary Shares and YS Biopharma Warrants are approved for listing on the Nasdaq (subject only to official notice of issuance thereof). While trading on the Nasdaq is expected to begin on the first business day following the date of the Closing, there can be no assurance that YS Biopharma’s securities will be listed on the Nasdaq or that a viable and active trading market will develop. See the section entitled “Risk Factors” beginning on page 61 for more information.

Holders of the securities of YS Biopharma are not holding equity securities of its subsidiaries that have substantive business operations in China but instead are holding equity securities of a Cayman Islands holding company. YS Biopharma is a Cayman Islands holding company that conducts the majority of its operations in China through its PRC subsidiaries, in particular, Liaoning Yisheng and Beijing Yisheng.

Recent regulatory development in China may exert more oversight and control over listing and offerings that are conducted overseas such as the Business Combination. The approval and/or other requirements of PRC governmental authorities may be required in connection with the Business Combination or YS Biopharma’s future issuance of securities on Nasdaq under PRC laws, regulations or policies. YS Group has conducted a substantial portion of its business in China, including, among others, manufacturing and sales of YSJA<sup>TM</sup> rabies vaccines and certain research and development activities. As such, YS Biopharma and its subsidiaries are subject to PRC laws relating to, among others, restrictions over foreign investments and data security. The Chinese government has recently sought to exert more control and impose more restrictions on China-based companies raising capital offshore and such efforts may continue or intensify in the future. For instance, the PRC governments initiated various regulatory actions and made various public statements, some of which are published with little advance notice, including cracking down on illegal activities in the securities market, enhancing supervision over China-based companies listed overseas, adopting new measures to extend the scope of cybersecurity reviews, and expanding efforts in anti-monopoly enforcement. The Chinese government has recently indicated an intent to exert more oversight and control over securities offerings and other capital markets activities that are conducted overseas and foreign investment in China-based companies like YS Group, which could result in a material adverse change in YS Group’s operations, significantly limit or completely hinder YS Biopharma’s ability to offer or continue to offer securities on Nasdaq, and cause the value of YS Biopharma’s securities to significantly decline or be worthless. YS Biopharma cannot assure you that the approval or permission or other filings will not be required under PRC laws, regulations or policies, nor can YS Biopharma predict whether or how long it will take to obtain such approval, permission or other filings in connection with the Business Combination or future issuance of securities on Nasdaq. Any failure to obtain or delay in obtaining the requisite governmental approval, permission or other filings for the Business Combination or future issuance of securities on Nasdaq or a rescission of such approval, permission or other filings, would subject YS Group to sanctions imposed by the relevant PRC regulatory authority. For details, see the section entitled “Risk Factors—Risks Related to Doing Business in China.”

YS Biopharma is subject to a number of prohibitions, restrictions and potential delisting risk under the Holding Foreign Companies Accountable Act (the “HFCAA”). Pursuant to the HFCAA and related regulations, if YS Biopharma has filed an audit report issued by a registered public accounting firm that the Public Company Accounting Oversight Board (the “PCAOB”) has determined that it is unable to inspect and investigate completely, the SEC will identify YS Biopharma as a “Commission-identified Issuer,” and the trading of YS Biopharma’s securities on any U.S. national securities exchanges, as well as any over-the-counter trading in the U.S., will be prohibited if it is identified as a Commission-identified Issuer for two consecutive years. On December 16, 2021, the PCAOB issued a report to notify the SEC of its determination that it is unable to inspect or investigate completely PCAOB-registered public accounting firms headquartered in mainland China and Hong Kong without the approval of the Chinese authorities. While YS Biopharma’s auditor, Wei, Wei & Co., LLP, is headquartered in the United States and not subject to such determinations, there is no guarantee that the audit work carried out by Wei, Wei & Co., LLP in collaboration of its China-based offices can be inspected or investigated completely by the PCAOB without such approval. On August 26, 2022, the PCAOB signed a Statement of Protocol with the China Securities Regulatory Commission (“CSRC”) and the Ministry of Finance of the People’s Republic of China, taking the first step toward opening access for the PCAOB to inspect and investigate registered public accounting firms headquartered in mainland China and Hong Kong. On December 15, 2022, the PCAOB announced that it was able to secure complete access to inspect and investigate PCAOB registered public accounting firms headquartered in mainland China and Hong Kong completely in 2022. The PCAOB Board vacated its previous 2021 determinations that the PCAOB was unable to inspect or investigate completely registered public accounting firms headquartered in mainland China and Hong Kong. However, whether the PCAOB will continue to be able to satisfactorily conduct inspections of PCAOB-registered public accounting firms headquartered in mainland China and Hong Kong is subject to uncertainties and depends on a number of factors out of our and our auditor’s control. The PCAOB continues to demand complete access in mainland China and Hong Kong moving forward and is making plans to resume regular inspections in early 2023 and beyond, as well as to continue pursuing ongoing investigations and initiate new investigations as needed. The PCAOB has also indicated that it will act immediately to consider the need to issue new determinations with the HFCAA if needed. YS Biopharma could still face the risk of delisting and cease of trading of its securities from a stock exchange or an over-the-counter market in the United States under the HFCAA and the securities regulations promulgated thereunder if the PCAOB is unable to inspect and investigate completely registered public accounting firms located in China in 2023 or beyond, or if YS Biopharma otherwise fails to meet the PCAOB’s requirements. See the

The information in this preliminary proxy statement/prospectus is not complete and may be changed. We may not issue these securities until the registration statement filed with the Securities and Exchange Commission is effective. This preliminary proxy statement/prospectus is not an offer to sell these securities and it is not soliciting an offer to buy these securities in any state where the offer or sale is not permitted.

section entitled “Risk Factors — Risks Related to Doing Business in China — YS Biopharma’s securities may be delisted under the Holding Foreign Companies Accountable Act if the PCAOB is unable to inspect auditors with presence in China in 2023 or beyond, and the delisting of its securities, or the threat of their being delisted, may materially and adversely affect the value of your investment.”

Cash is transferred among YS Biopharma, its offshore subsidiaries and its PRC subsidiaries, in the following manner: (i) funds are transferred to its PRC subsidiaries from YS Biopharma as needed through YS Biopharma’s subsidiaries outside China in the form of capital contributions or shareholder loans, as the case may be; and (ii) dividends or other distributions may be paid by its PRC subsidiaries to the Company through its subsidiaries outside China. Its subsidiaries in the PRC generate and retain cash generated from operating activities and re-invest it in its business. None of its subsidiaries outside China has made distribution to certain shareholders. In the future, YS Biopharma’s ability to pay dividends, if any, to its shareholders and warrant holders and to service any debt it may incur will depend upon dividends paid by its subsidiaries. In the fiscal years ended March 31, 2021 and 2022 and the six months ended September 30, 2022, YS Group did not transfer any cash proceeds to any of its PRC subsidiaries except for the cash transfers within its Group in connection with the paid-in capital in its PRC subsidiaries. \$59,900,000, \$45,099,071.49 and \$45,099,071.49 of the registered capital was paid up by HK Yisheng to Liaoning Yisheng during the fiscal year ended March 31, 2021 and 2022 and in the six months ended September 30, 2022, respectively. In the future, cash proceeds raised from overseas financing activities may be transferred by YS Biopharma through its subsidiaries outside China to its PRC subsidiaries via capital contribution and shareholder loans, as the case may be. Its PRC subsidiaries will pay dividends to their offshore shareholder to meet the capital needs of YS Biopharma’s business operations out of the PRC. For details about the applicable PRC regulations and rules relating to such cash transfers through YS Group and the associated risks, see “Risk Factors — Risks Related to Doing Business in China.”

Upon the consummation of the Business Combination, YS Biopharma will be an “emerging growth company” as that term is used in the Jumpstart Our Business Startups Act of 2012, as amended, and, as such, may elect to comply with certain reduced public company reporting requirements in future reports after the consummation of the Business Combination.

YS Biopharma is also a “foreign private issuer” as defined in the Exchange Act, and will be exempt from certain rules under the Exchange Act that impose certain disclosure obligations and procedural requirements for proxy solicitations under Section 14 of the Exchange Act. In addition, YS Biopharma’s officers, directors and principal shareholders will be exempt from the reporting and “short-swing” profit recovery provisions under Section 16 of the Exchange Act. Moreover, YS Biopharma will not be required to file periodic reports and financial statements with the U.S. Securities and Exchange Commission as frequently or as promptly as U.S. companies whose securities are registered under the Exchange Act.

Upon the consummation of the Business Combination, YS Biopharma may become a “controlled company” as defined under the Nasdaq corporate governance rules, because it is expected that Mr. Yi Zhang, Founder and Chairman of the Board of Directors of YS Biopharma, will beneficially control over 50% of the total voting power of all issued and outstanding YS Biopharma Ordinary Shares through the acting-in-concert arrangement under the Concert Party Agreement immediately following the consummation of the Business Combination, if 75% or more of the Summit Public Shareholders will redeem their Summit Public Shares. See the section entitled “Certain Relationships and Related Person Transactions — YS Group and YS Biopharma Relationships and Related Party Transactions — Concert Party Agreement” for details. As a result, Mr. Yi Zhang will have the ability to exercise significant influence over the matters requiring approval by shareholders such as decisions regarding election of directors and other significant corporate actions. YS Biopharma does not currently plan to utilize the exemptions available for controlled companies after the completion of the Business Combination, but instead, it intends to rely on the exemption available for foreign private issuers to follow its home country governance practices. As a result, you will not have the same protection afforded to shareholders of companies that are subject to these corporate governance requirements. For details, see sections entitled “Risk Factor — Risks Related to Ownership of the YS Biopharma Ordinary Shares — As an exempted company incorporated in the Cayman Islands, YS Biopharma is permitted to adopt certain home country practices in relation to corporate governance matters that differ significantly from Nasdaq’s corporate governance requirements; these practices may afford less protection to shareholders. If YS Biopharma opts to rely on such exemptions in the future, such decision might afford less protection to holders of YS Biopharma’s ordinary shares” and “Risk Factor — Risks Related to Ownership of the YS Biopharma Ordinary Shares — The post-combination company may be a “controlled company” within the meaning of the Nasdaq Stock Market listing rules and, as a result, may rely on exemptions from certain corporate governance requirements that provide protection to shareholders of other companies.”

**This proxy statement/prospectus provides you with detailed information about the Business Combination and other matters to be considered at the Extraordinary General Meeting of holders of Summit Shares. We encourage you to carefully read this entire document. You should, in particular, carefully consider the risk factors described in “Risk Factors” beginning on page 61 of this proxy statement/prospectus.**

The board of directors of Summit (the “Summit Board”) has unanimously approved and adopted the Business Combination Agreement and unanimously recommends that the Summit Shareholders vote FOR all of the proposals presented to the shareholders at the Extraordinary General Meeting. When you consider the Summit Board’s recommendation of these proposals, you should keep in mind that Summit’s directors and officers have interests in the Business Combination that may conflict with your interests as a shareholder. See the section entitled “The Business Combination Proposal — Interests of Summit’s Directors, Officers and the Sponsor in the Business Combination.”



**ADDITIONAL INFORMATION**

**No person is authorized to give any information or to make any representation with respect to the matters that this proxy statement/prospectus describes other than those contained in this proxy statement/ prospectus, and, if given or made, the information or representation must not be relied upon as having been authorized by Summit or YS Biopharma. This proxy statement/prospectus does not constitute an offer to sell or a solicitation of an offer to buy securities or a solicitation of a proxy in any jurisdiction where, or to any person to whom, it is unlawful to make such an offer or a solicitation. Neither the delivery of this proxy statement/prospectus nor any distribution of securities made under this proxy statement/prospectus will, under any circumstances, create an implication that there has been no change in the affairs of Summit or YS Biopharma since the date of this proxy statement/prospectus or that any information contained herein is correct as of any time subsequent to such date.**

---

**SUMMIT HEALTHCARE ACQUISITION CORP.**

Unit 1101, 11th Floor  
1 Lyndhurst Tower, 1 Lyndhurst Terrace  
Central, Hong Kong

**NOTICE OF EXTRAORDINARY GENERAL MEETING  
TO BE HELD ON MARCH 1, 2023**

Dear Summit Healthcare Acquisition Corp. Shareholders:

You are cordially invited to attend the extraordinary general meeting of shareholders (the “Extraordinary General Meeting”) of Summit Healthcare Acquisition Corp., an exempted company limited by shares incorporated under the laws of the Cayman Islands (“Summit”), at 9:00 a.m. Eastern Time, on March 1, 2023 at 35th Floor, Two Exchange Square, 8 Connaught Place Central, Hong Kong and virtually at <https://www.csproxy.com/summithealthcarespac/2023>, and on such other date and at such other place to which the meeting may be adjourned. While, as a matter of Cayman Islands law, we are required to have a physical location for the meeting, we are pleased to utilize virtual shareholder meeting technology to (i) provide ready access and cost savings for Summit Shareholders and Summit and (ii) to promote social distancing due to COVID-19 pandemic. We encourage you to attend the Extraordinary General Meeting virtually. Capitalized terms used but not otherwise defined herein shall have the meanings ascribed to them in the accompanying proxy statement/prospectus.

The Extraordinary General Meeting shall be held for the purposes of considering and voting upon, and if through fit passing and approving, the following resolutions:

- 1. Proposal No. 1 — The Business Combination Proposal** — as an ordinary resolution, that the Business Combination Agreement, a copy of which is included as **Annex A** to the accompanying proxy statement/prospectus, and the transactions contemplated therein, whereby (i) Merger Sub I will merge with and into Summit (the “First Merger”), with Summit surviving the First Merger as the surviving entity (the “Surviving Entity”) and becoming a wholly-owned subsidiary of YS Biopharma, and (ii) promptly thereafter and as part of the same overall transaction, the Surviving Entity will merge with and into Merger Sub II (the “Second Merger,” and together with the First Merger, the “Mergers”), with Merger Sub II surviving the Second Merger as the surviving company (the “Surviving Company”) and remaining as the wholly-owned subsidiary of YS Biopharma, be approved and authorized in all respects.
  - 2. Proposal No. 2 — The Merger Proposal** — as a special resolution, that the First Merger and the Plan of First Merger, a copy of which is included as **Annex C** to the accompanying proxy statement/prospectus, and any and all transactions provided for in the First Plan of Merger, including, without limitation (a) the First Merger, (b) at the effective time of the First Merger (the “First Merger Effective Time”), the amendment and restatement of the Summit Articles by deletion in their entirety and the substitution in their place of the amended and restated memorandum and articles of association of Summit (as the Surviving Entity) in the form attached as Annex 2 to the Plan of First Merger (the “Surviving Entity Articles”), being the memorandum and articles of association of Merger Sub I, and (c) at the First Merger Effective Time, the redesignation of all authorized class A ordinary shares of \$0.0001 par value per share and class B ordinary shares of \$0.0001 par value per share of the Surviving Entity as ordinary shares of \$0.0001 par value per share, such that the authorized share capital of the Surviving Entity will become \$45,500 divided into 455,000,000 ordinary shares of a par value of \$0.0001 per share, with such rights, privileges and conditions as set out in the Surviving Entity Articles be approved and authorized in all respects.
  - 3. Proposal No. 3 — The Adjournment Proposal** — as an ordinary resolution, that the Extraordinary General Meeting be adjourned to a later date or dates to be determined by the chairman of the Extraordinary General Meeting as necessary, including without limitation (a) to permit further solicitation and vote of proxies if, based upon the tabulated vote at the time of the Extraordinary General Meeting, there are insufficient votes to approve any of the other proposals presented to shareholders for vote, (b) to the extent necessary, to ensure that any required supplement or amendment to the accompanying proxy statement/prospectus is provided to Summit Shareholders, or (c) if, as of the time for which the Extraordinary General Meeting is scheduled, there are insufficient Summit Shares
-



represented (either in person or by proxy) to constitute a quorum necessary to conduct business at the Extraordinary General Meeting.

Under the Business Combination Agreement, the approval of the Business Combination Proposal and the Merger Proposal by the requisite vote of Summit Shareholders is a condition to the consummation of the Business Combination. Each of the Business Combination Proposal and the Merger Proposal are cross-conditioned on the approval of each other. If any one of these proposals is not approved by Summit Shareholders, the Business Combination shall not be consummated. The Adjournment Proposal is not conditioned upon the approval of any other Proposal set forth in the accompanying proxy statement/prospectus.

We also will transact any other business as may properly come before the Extraordinary General Meeting or any adjournment or postponement thereof.

Following the First Merger Effective Time, the Plan of Second Merger will be approved by YS Biopharma as the sole shareholder of both the Surviving Entity and Merger Sub II, pursuant to which the Second Merger will be consummated.

Pursuant to the Summit Articles, a holder of Summit Public Shares issued as part of the Units in the IPO (“Summit Public Shareholder”) may request that Summit redeem all or a portion of such Summit Public Shares for cash in connection with the completion of the Business Combination. Holders of Units must elect to separate the Units into the underlying Summit Public Shares and Summit Public Warrants prior to exercising redemption rights with respect to the Summit Public Shares. If holders hold their Units in an account at a brokerage firm or bank, holders must notify their broker or bank that they elect to separate the Units into the underlying Summit Public Shares and Summit Public Warrants, or if a holder holds Units registered in its own name, the holder must contact Continental Stock Transfer & Trust Company (“Continental”), directly and instruct it to do so. The redemption rights include the requirement that a beneficial holder must identify itself in writing as a beneficial holder and provide its legal name, phone number and address to Continental in order to validly redeem its shares. **Summit Public Shareholders are not required to affirmatively vote for or against the Business Combination Proposal, or to vote on the Business Combination Proposal at all, or to be holders of record on the record date in order to have their Summit Public Shares redeemed.** If the Business Combination is not consummated, Summit shall redeem the Summit Public Shares, at a per-Share price, payable in cash, equal to the aggregate amount then on deposit in the Trust Account, including interest earned on the funds held in the Trust Account and not previously released to Summit (less taxes payable and up to \$100,000 of interest to pay dissolution expenses), divided by the number of then Summit Public Shares in issue, which redemption will completely extinguish the Summit Public Shareholders’ rights as Summit Public Shareholders (including the right to receive further liquidation distributions, if any). This may result in Summit Shareholders receiving less than they would have received if the Business Combination was completed and they had exercised redemption rights in connection therewith due to potential claims of creditors. If the Business Combination is consummated, and if a Summit Public Shareholder properly exercises its right to redeem all or a portion of the Summit Public Shares that it holds, Summit will redeem such Summit Public Shares for a per-share redemption price, payable in cash, equal to the aggregate amount then on deposit in the Trust Account calculated as of two business days prior to the consummation of the Business Combination, including interest earned on the funds held in the Trust Account (such interest shall be net of taxes payable) and not previously released to Summit to pay its taxes divided by the number of then issued Summit Public Shares. Summit shall not redeem the Summit Public Shares that would cause Summit’s net tangible assets to be less than \$5,000,001. For illustrative purposes, as of February 2, 2023, the record date of the Extraordinary General Meeting (the “Record Date”), this would have amounted to approximately \$10.1 per issued and outstanding Summit Public Share. If a Summit Public Shareholder exercises its redemption rights in full, then it will be electing to exchange its Summit Public Shares for cash and will no longer own Summit Public Shares (but will continue to own any Summit Public Warrants it may hold). See the section entitled “Extraordinary General Meeting of Summit Shareholders — Redemption Rights” in the accompanying proxy statement/prospectus for a detailed description of the procedures to be followed if you wish to redeem your Summit Public Shares for cash.

Notwithstanding the foregoing, a Summit Public Shareholder, together with any affiliate of such Summit Public Shareholder or any other person with whom such Summit Public Shareholder is acting in concert or as a “group” (as defined in Section 13(d)(3) of the Securities Exchange Act of 1934, as amended

---

("Exchange Act")), will be restricted from seeking redemption rights with respect to more than an aggregate of 15% of the Summit Public Shares without the prior consent of Summit. Accordingly, if a Summit Public Shareholder, alone or acting in concert or as a group, seeks to redeem more than 15% of the Summit Public Shares, then any such shares in excess of that 15% limit would not be redeemed for cash.

The Business Combination Agreement is subject to the satisfaction or waiver of certain other closing conditions as described in the accompanying proxy statement/prospectus. There can be no assurance that the parties to the Business Combination Agreement would waive any such closing condition. In addition, in no event will Summit redeem Summit Public Shares in an amount that would cause Summit's net tangible assets (as determined in accordance with Rule 3a51-1(g)(1) of the Exchange Act) to be less than \$5,000,001 after giving effect to the transactions contemplated by the Business Combination Agreement.

**After careful consideration, the Summit Board has unanimously approved the Business Combination and determined that the Business Combination Proposal, the Merger Proposal and the Adjournment Proposal are advisable and fair to and in the best interest of Summit and unanimously recommends that you vote or give instruction to vote "FOR" the Business Combination Proposal, "FOR" the Merger Proposal and "FOR" the Adjournment Proposal, if presented. When you consider the Summit Board's recommendation of these proposals, you should keep in mind that Summit's directors and officers and the Sponsor have interests in the Business Combination that may conflict with, or are different from, your interests as a shareholder of Summit. See the section entitled "The Business Combination Proposal—Interests of Summit's Directors, Officers, and the Sponsor in the Business Combination" in the accompanying proxy statement/prospectus for a further discussion of these considerations.**

Summit is providing the accompanying proxy statement/prospectus and accompanying proxy card to Summit Shareholders in connection with the solicitation of proxies to be voted at the Extraordinary General Meeting and at any adjournments or postponements of the Extraordinary General Meeting. Information about the Extraordinary General Meeting, the Business Combination and other related business to be considered by Summit Shareholders at the Extraordinary General Meeting is included in the accompanying proxy statement/prospectus. **Whether or not you plan to attend the Extraordinary General Meeting, all of Summit Shareholders should read the accompanying proxy statement/prospectus, including the Annexes and other documents referred to therein, carefully and in their entirety, before the voting. You should also carefully consider the risk factors described in "Risk Factors" beginning on page 61 of the accompanying proxy statement/prospectus.**

Only holders of record of Summit Shares at the close of business on the Record Date are entitled to notice of the Extraordinary General Meeting and to vote and have their votes counted at the Extraordinary General Meeting and any adjournments or postponements of the Extraordinary General Meeting.

The approval of the Business Combination Proposal will require an ordinary resolution under Cayman Islands law and the Summit Articles, being the affirmative vote of the holders of a majority of the issued and outstanding Summit Shares present in person physically or by virtual attendance or represented by proxy and entitled to vote at the Extraordinary General Meeting. The approval of the Merger Proposal will require a special resolution under Cayman Islands law and the Summit Articles, being the affirmative vote of the holders of at least two-thirds of the issued and outstanding Summit Shares present in person physically or by virtual attendance or represented by proxy and entitled to vote at the Extraordinary General Meeting. The approval of the Adjournment Proposal, if presented, will require an ordinary resolution under Cayman Islands law and the Summit Articles, being the affirmative vote of the holders of a majority of the issued and outstanding Summit Shares present in person physically or by virtual attendance or represented by proxy and entitled to vote at the Extraordinary General Meeting. Brokers are not entitled to vote on the Business Combination Proposal, the Merger Proposal or the Adjournment Proposal absent voting instructions from the beneficial holder. An abstention or broker non-vote will be counted towards the quorum requirement but will not count as a vote cast at the Extraordinary General Meeting.

The Sponsor and the independent directors of Summit have agreed to, among other things, vote all of their Summit Shares in favor of the proposals being presented at the Extraordinary General Meeting in connection with the Business Combination and waive their redemption rights with respect to their Summit Shares in connection with the consummation of the Business Combination. The Forward Purchase Investors have also agreed to, among other things, vote all of their Summit Shares in favor of the proposals being presented at the Extraordinary General Meeting in connection with the Business Combination and waive their redemption

---

rights with respect to all of the Summit Class B Ordinary Shares held by them in connection with the consummation of the Business Combination. As of the date of the accompanying proxy statement/prospectus, on an as-converted basis, the Sponsor, Summit's independent directors and the Forward Purchase Investors own, collectively, approximately 22.3% of the issued and outstanding Summit Shares.

**Your vote is important regardless of the number of Summit Shares you own. Whether or not you plan to attend the Extraordinary General Meeting, please complete, sign, date and return the enclosed proxy card as soon as possible in the pre-addressed postage paid envelope provided and in any event so as to be received by Summit no later than at 9:00 a.m. Eastern Time, on February 27, 2023, being 48 hours before the time appointed for the holding of the Extraordinary General Meeting (or, in the case of an adjournment, no later than 48 hours before the time appointed for the holding of the adjourned meeting) to make sure that your Summit Shares are represented at the Extraordinary General Meeting. If your Summit Shares are held in "street name" or are in a margin or similar account, you should contact your broker, bank or nominee to ensure that votes related to the Summit Shares you beneficially own are properly counted.**

If you sign, date and return your proxy card without indicating how you wish to vote, your proxy will be voted FOR each of the proposals presented at the Extraordinary General Meeting. If you are a shareholder of record and fail to return your proxy card and do not attend the Extraordinary General Meeting in person (including virtually), or if you fail to instruct your bank, broker or other nominee how to vote the Summit Shares you beneficially own, the effect will be, among other things, that your Summit Shares will not be counted for purposes of determining whether a quorum is present at the Extraordinary General Meeting and will not be voted.

**TO EXERCISE YOUR REDEMPTION RIGHTS, YOU MUST DEMAND IN WRITING THAT SUMMIT REDEEM YOUR SUMMIT PUBLIC SHARES FOR A PRO RATA PORTION OF THE FUNDS HELD IN THE TRUST ACCOUNT AND EITHER TENDER YOUR SHARE CERTIFICATES (IF ANY) TO CONTINENTAL STOCK TRANSFER & TRUST COMPANY, SUMMIT'S TRANSFER AGENT OR DELIVER YOUR SUMMIT PUBLIC SHARES TO THE TRANSFER AGENT ELECTRONICALLY USING THE DEPOSITORY TRUST COMPANY'S DWAC (DEPOSIT WITHDRAWAL AT CUSTODIAN) SYSTEM, IN EACH CASE AT LEAST TWO BUSINESS DAYS PRIOR TO THE VOTE AT THE EXTRAORDINARY GENERAL MEETING. ANY HOLDER THAT HOLDS SUMMIT PUBLIC SHARES BENEFICIALLY THROUGH A NOMINEE MUST IDENTIFY ITSELF AS A BENEFICIAL HOLDER AND PROVIDE ITS LEGAL NAME, PHONE NUMBER AND ADDRESS IN ITS WRITTEN DEMAND IN ORDER TO VALIDLY REDEEM SUCH SHARES. IF THE BUSINESS COMBINATION IS NOT COMPLETED, THEN THESE SHARES SHALL BE RETURNED TO YOU OR YOUR ACCOUNT. IF YOU HOLD YOUR SUMMIT PUBLIC SHARES IN "STREET NAME", YOU NEED TO INSTRUCT THE ACCOUNT EXECUTIVE AT YOUR BROKER, BANK OR OTHER NOMINEE TO WITHDRAW THE SHARES FROM YOUR ACCOUNT IN ORDER TO EXERCISE YOUR REDEMPTION RIGHTS. SEE THE SECTION ENTITLED "EXTRAORDINARY GENERAL MEETING OF SUMMIT SHAREHOLDERS — REDEMPTION RIGHTS" FOR MORE SPECIFIC INSTRUCTIONS.**

If you have any questions about how to vote or direct a vote in respect of your Summit Ordinary Shares, you may call Advantage Proxy, Inc., Summit's proxy solicitor, at 1-877-870-8565 or email at [ksmith@advantageproxy.com](mailto:ksmith@advantageproxy.com). This notice of Extraordinary General Meeting is and the proxy statement/prospectus relating to the Business Combination will be available at <https://www.cstproxy.com/summithealthcarespac/2023>.

On behalf of Summit's board of directors, I would like to thank you for your support and look forward to the successful completion of the Business Combination.

Sincerely,

[                    ]

Bo Tan  
Chief Executive Officer, Co-Chief Investment  
Officer and Director

NEITHER THE SECURITIES AND EXCHANGE COMMISSION NOR ANY STATE SECURITIES REGULATORY AGENCY HAS APPROVED OR DISAPPROVED THE TRANSACTIONS

DESCRIBED IN THE ACCOMPANYING PROXY STATEMENT/PROSPECTUS, PASSED UPON THE MERITS OR FAIRNESS OF THE BUSINESS COMBINATION OR RELATED TRANSACTIONS OR PASSED UPON THE ADEQUACY OR ACCURACY OF THE DISCLOSURE IN THE ACCOMPANYING PROXY STATEMENT/PROSPECTUS. ANY REPRESENTATION TO THE CONTRARY CONSTITUTES A CRIMINAL OFFENSE.

The accompanying proxy statement/prospectus is dated [        ], and is first being mailed to shareholders of Summit on or about [        ].



## TABLE OF CONTENT

	<u>PAGES</u>
<a href="#"><u>ADDITIONAL INFORMATION</u></a>	<a href="#"><u>1</u></a>
<a href="#"><u>ABOUT THIS PROXY STATEMENT/PROSPECTUS</u></a>	<a href="#"><u>2</u></a>
<a href="#"><u>INDUSTRY AND MARKET DATA</u></a>	<a href="#"><u>3</u></a>
<a href="#"><u>FREQUENTLY USED TERMS</u></a>	<a href="#"><u>4</u></a>
<a href="#"><u>QUESTIONS AND ANSWERS ABOUT THE PROPOSALS</u></a>	<a href="#"><u>9</u></a>
<a href="#"><u>SUMMARY OF THE PROXY STATEMENT/PROSPECTUS</u></a>	<a href="#"><u>30</u></a>
<a href="#"><u>SELECTED HISTORICAL FINANCIAL DATA OF SUMMIT</u></a>	<a href="#"><u>51</u></a>
<a href="#"><u>SELECTED HISTORICAL FINANCIAL DATA OF YS BIOPHARMA</u></a>	<a href="#"><u>52</u></a>
<a href="#"><u>SUMMARY UNAUDITED PRO FORMA CONDENSED COMBINED FINANCIAL INFORMATION</u></a>	<a href="#"><u>55</u></a>
<a href="#"><u>COMPARATIVE PER SHARE INFORMATION</u></a>	<a href="#"><u>57</u></a>
<a href="#"><u>FORWARD-LOOKING STATEMENTS</u></a>	<a href="#"><u>59</u></a>
<a href="#"><u>RISK FACTORS</u></a>	<a href="#"><u>61</u></a>
<a href="#"><u>EXTRAORDINARY GENERAL MEETING OF SUMMIT SHAREHOLDERS</u></a>	<a href="#"><u>142</u></a>
<a href="#"><u>THE BUSINESS COMBINATION AGREEMENT</u></a>	<a href="#"><u>148</u></a>
<a href="#"><u>AGREEMENTS ENTERED INTO IN CONNECTION WITH THE BUSINESS COMBINATION</u></a>	<a href="#"><u>158</u></a>
<a href="#"><u>PROPOSAL NO. 1 — THE BUSINESS COMBINATION PROPOSAL</u></a>	<a href="#"><u>160</u></a>
<a href="#"><u>PROPOSAL NO. 2 — THE MERGER PROPOSAL</u></a>	<a href="#"><u>185</u></a>
<a href="#"><u>PROPOSAL NO. 3 — THE ADJOURNMENT PROPOSAL</u></a>	<a href="#"><u>186</u></a>
<a href="#"><u>INFORMATION RELATED TO SUMMIT</u></a>	<a href="#"><u>187</u></a>
<a href="#"><u>SUMMIT'S MANAGEMENT'S DISCUSSION AND ANALYSIS OF FINANCIAL CONDITION AND RESULTS OF OPERATION</u></a>	<a href="#"><u>202</u></a>
<a href="#"><u>YS BIOPHARMA'S MARKET OPPORTUNITIES</u></a>	<a href="#"><u>206</u></a>
<a href="#"><u>YS BIOPHARMA'S BUSINESS</u></a>	<a href="#"><u>221</u></a>
<a href="#"><u>YS BIOPHARMA'S MANAGEMENT'S DISCUSSION AND ANALYSIS OF FINANCIAL CONDITION AND RESULTS OF OPERATIONS</u></a>	<a href="#"><u>305</u></a>
<a href="#"><u>UNAUDITED PRO FORMA CONDENSED COMBINED FINANCIAL INFORMATION</u></a>	<a href="#"><u>328</u></a>
<a href="#"><u>MANAGEMENT FOLLOWING THE BUSINESS COMBINATION</u></a>	<a href="#"><u>341</u></a>
<a href="#"><u>MATERIAL TAX CONSIDERATIONS</u></a>	<a href="#"><u>351</u></a>
<a href="#"><u>DESCRIPTION OF YS BIOPHARMA'S SECURITIES</u></a>	<a href="#"><u>363</u></a>
<a href="#"><u>COMPARISON OF CORPORATE GOVERNANCE AND SHAREHOLDER RIGHTS</u></a>	<a href="#"><u>368</u></a>
<a href="#"><u>BENEFICIAL OWNERSHIP OF SECURITIES</u></a>	<a href="#"><u>375</u></a>
<a href="#"><u>CERTAIN RELATIONSHIPS AND RELATED PERSON TRANSACTIONS</u></a>	<a href="#"><u>377</u></a>
<a href="#"><u>SHARES ELIGIBLE FOR FUTURE SALE</u></a>	<a href="#"><u>380</u></a>
<a href="#"><u>PRICE RANGE OF SECURITIES AND DIVIDEND INFORMATION</u></a>	<a href="#"><u>382</u></a>
<a href="#"><u>APPRAISAL RIGHTS</u></a>	<a href="#"><u>383</u></a>
<a href="#"><u>FUTURE SHAREHOLDER PROPOSALS AND NOMINATIONS</u></a>	<a href="#"><u>384</u></a>
<a href="#"><u>SHAREHOLDER COMMUNICATIONS</u></a>	<a href="#"><u>385</u></a>
<a href="#"><u>DELIVERY OF DOCUMENTS TO SHAREHOLDERS</u></a>	<a href="#"><u>386</u></a>
<a href="#"><u>TRANSFER AGENT AND REGISTRAR</u></a>	<a href="#"><u>387</u></a>
<a href="#"><u>WHERE YOU CAN FIND MORE INFORMATION</u></a>	<a href="#"><u>388</u></a>
<a href="#"><u>LEGAL MATTERS</u></a>	<a href="#"><u>389</u></a>
<a href="#"><u>EXPERTS</u></a>	<a href="#"><u>390</u></a>
<a href="#"><u>INDEX OF FINANCIAL STATEMENTS</u></a>	<a href="#"><u>F-1</u></a>

	<u>PAGES</u>
<b>ANNEXES</b>	
<u>ANNEX A: BUSINESS COMBINATION AGREEMENT</u>	<u>A-1</u>
<u>ANNEX B: AMENDED AND RESTATED MEMORANDUM AND ARTICLES OF ASSOCIATION OF YS BIOPHARMA</u>	<u>B-1</u>
<u>ANNEX C: PLAN OF FIRST MERGER</u>	<u>C-1</u>
<u>ANNEX D: FAIRNESS OPINION OF VALUESCOPE, INC.</u>	<u>D-1</u>

**ADDITIONAL INFORMATION**

You may request copies of this proxy statement/prospectus and any other publicly available information concerning Summit, without charge, by written request to Advantage, our proxy solicitor, at 1-877-870-8565 or email at [ksmith@advantageproxy.com](mailto:ksmith@advantageproxy.com), or banks and brokers can call collect at 1-206-870-8565, or by emailing [ksmith@advantageproxy.com](mailto:ksmith@advantageproxy.com), or from the SEC through the SEC website at <http://www.sec.gov>.

In order for holders of Summit Shares to receive timely delivery of the documents in advance of the Extraordinary General Meeting of Summit to be held on March 1, 2023 you must request the information no later than five business days prior to the date of the Extraordinary General Meeting, by February 22, 2023.

**ABOUT THIS PROXY STATEMENT/PROSPECTUS**

This document, which forms part of a registration statement on Form F-4 filed with the U.S. Securities and Exchange Commission (the “SEC”) by YS Biopharma, constitutes a prospectus of YS Biopharma under Section 5 of the U.S. Securities Act of 1933, as amended (the “Securities Act”) with respect to the YS Biopharma Ordinary Shares to be issued to Summit Shareholders, the YS Biopharma Warrants to be issued to Summit warrant holders and the YS Biopharma Ordinary Shares underlying such warrants, if the Business Combination described herein is consummated. This document also constitutes a notice of meeting and a proxy statement under Section 14(a) of the U.S. Securities Exchange Act of 1934, as amended (the “Exchange Act”), with respect to the Extraordinary General Meeting of holders of Summit Shares at which Summit Shareholders shall be asked to consider and vote upon proposals to approve the Business Combination Proposal, the Merger Proposal and to approve the Adjournment Proposal, if necessary, to permit further solicitation of proxies because there are not sufficient votes to adopt the Business Combination Proposal or the Merger Proposal.

Discrepancies in any table between totals and sums of the amounts listed are due to rounding. Certain amounts and percentages have been rounded; consequently, certain figures may add up to be more or less than the total amount and certain percentages may add up to be more or less than 100% due to rounding. In particular and without limitation, amounts expressed in millions contained in this proxy statement/prospectus have been rounded to a single decimal place for the convenience of readers.



### **INDUSTRY AND MARKET DATA**

The industry and market position information that appears in this proxy statement/prospectus is from independent market research carried out by Frost & Sullivan, which was commissioned by YS Biopharma.

Such information is supplemented where necessary with YS Biopharma's own internal estimates and information obtained from discussions with its customers, taking into account publicly available information about other industry participants and YS Biopharma's management's judgment where information is not publicly available. This information appears in "Summary of the Proxy Statement/Prospectus," "YS Group's Business" and "YS Biopharma's Management's Discussion and Analysis of Financial Condition and Results of Operations" and other sections of this proxy statement/prospectus.

## FREQUENTLY USED TERMS

Unless otherwise stated or unless the context otherwise requires in this document:

“Adjournment Proposal” means the Summit shareholder proposal by ordinary resolution to approve the adjournment of the Extraordinary General Meeting for the purpose of soliciting additional proxies in favor of the approval of the Business Combination in the event Summit does not receive the requisite shareholder vote to approve the Business Combination;

“Amended YS Biopharma Articles” means YS Biopharma’s amended and restated memorandum and articles adopted by special resolution dated September 23, 2022 and to become effective immediately prior to the First Merger Effective Time;

“Beijing Yisheng” means Beijing Yisheng Biotechnology Co., Ltd., a company incorporated under the laws of the PRC with limited liability and a wholly-owned subsidiary of YS Biopharma;

“Business Combination” or “Transactions” means the Mergers and the other transactions contemplated by the Business Combination Agreement;

“Business Combination Agreement” means the business combination agreement, dated September 29, 2022 (as may be amended, supplemented, or otherwise modified from time to time), by and among Summit, Merger Sub I, Merger Sub II and YS Biopharma;

“Business Combination Proposal” means the Summit shareholder proposal by ordinary resolution to approve the Business Combination Agreement and the Business Combination;

“Cayman Islands Companies Act” means the Companies Act (As Revised) of the Cayman Islands;

“China” or “PRC” means the People’s Republic of China (and, only in the context of describing the industry matters, including those derived from the F&S report, and the PRC laws, rules, regulations, regulatory authorities, and any PRC entities or citizens under such rules, laws and regulations and other legal, regulatory or tax matters and advices in this proxy statement/prospectus, excludes Hong Kong, Macau and Taiwan). The term “Chinese” has a correlative meaning for the purpose of this proxy statement/prospectus;

“Closing” means the closing of the Mergers;

“Closing Date” means the date of the Closing;

“Code” means the Internal Revenue Code of the 1986, as amended;

“Condition Precedent Proposals” mean all Proposals, except for the Adjournment Proposal;

“Continental” means Continental Stock Transfer & Trust Company, Summit’s transfer agent;

“Dissent Rights” means the right of each holder of record of Summit Shares to dissent in respect of the Merger pursuant to Section 238 of the Cayman Islands Companies Act;

“Dissenting Summit Shareholders” means holders of Dissenting Summit Shares;

“Dissenting Summit Shares” means Summit Shares that are (i) issued and outstanding immediately prior to the First Merger Effective Time and (ii) held by Summit Shareholders who have validly exercised their Dissent Rights (and not waived, withdrawn, lost or failed to perfect such rights);

“Exchange Act” means the U.S. Securities Exchange Act of 1934, as amended;

“Existing Warrant Agreement” means the warrant agreement, dated May 13, 2021, by and between Summit and Continental;

“Extraordinary General Meeting” means an extraordinary general meeting of holders of Summit Shares to be held at 9:00 a.m. Eastern Time, on March 1, 2023 at 35th Floor, Two Exchange Square, 8 Connaught Place Central, Hong Kong and virtually at <https://www.cstproxy.com/summithealthcarespac/2023>;

“Final Redemption Date” means June 11, 2023 or such later date as may be approved by Summit’s shareholders in an amendment to the Summit Articles;

“First Merger Effective Time” means the time when the Plan of First Merger is registered by the Registrar of Companies of the Cayman Islands or such later time (being not later than the 90<sup>th</sup> day after registration by the Registrar of Companies of the Cayman Islands) as Merger Sub I and Summit may agree and specify in the Plan of First Merger pursuant to the Cayman Islands Companies Act;

“Forward Purchase Agreements” means (i) the forward purchase agreement entered into as of April 30, 2021 between Summit and Snow Lake Capital (HK) Limited; and (ii) the forward purchase agreement entered into as of April 30, 2021 between Summit and the Valliance Fund;

“Forward Purchase Investors” means Snow Lake Capital (HK) Limited and the Valliance Fund;

“Forward Purchase Subscriptions” means the purchases of 3,000,000 Summit Class A Ordinary Shares and 750,000 Summit Warrants by the Forward Purchase Investors for an aggregate purchase price of \$30,000,000 pursuant to the Forward Purchase Agreements in a private placement to close immediately prior to the First Merger Effective Time;

“First Merger” means the merger between Summit and Merger Sub I, with Summit being the surviving entity and becoming a wholly-owned subsidiary of YS Biopharma;

“HK Yisheng” means YishengBio (Hong Kong) Holdings Limited, a company incorporated under the laws of Hong Kong with limited liability and a wholly-owned subsidiary of YS Biopharma;

“Initial Shareholders” means the Sponsor, Ian Stone, Thomas Folinsbee, Tao Bai and the Forward Purchase Investors;

“IPO” means Summit’s initial public offering, which was consummated on June 11, 2021;

“Liaoning Yisheng” means Liaoning Yisheng Biopharma Co., Ltd., a company with limited liability under the laws of the PRC with limited liability and a wholly-owned subsidiary of YS Biopharma;

“Mergers” means collectively, the First Merger and the Second Merger;

“Merger Proposal” means the Summit shareholder proposal by special resolution to approve the First Merger;

“Merger Subs” means collectively Merger Sub I and Merger Sub II;

“Merger Sub I” means Oceanview Bioscience Acquisition Co., Ltd., an exempted company limited by shares incorporated under the laws of the Cayman Islands and a direct wholly-owned subsidiary of YS Biopharma;

“Merger Sub II” means Hudson Biomedical Group Co., Ltd., an exempted company limited by shares incorporated under the laws of the Cayman Islands and a direct wholly-owned subsidiary of YS Biopharma;

“Nasdaq” means the Nasdaq Stock Market;

“Non-Redeeming Summit Shares” means, without duplication, (a) 375,000 Summit Class B Ordinary Shares held by the Forward Purchase Investors, (b) 3,000,000 Summit Class A Ordinary Shares to be purchased by the Forward Purchase Investors pursuant to the Forward Purchase Agreements and (c) Summit Ordinary Shares in respect of which the holder thereof is eligible (as determined in accordance with the Summit Articles) and has not validly exercised (or has validly revoked, withdrawn or lost) his, her or its Summit Shareholder Redemption Right, excluding (i) Redeeming Summit Shares and (ii) Dissenting Summit Shares;

“PCAOB” means the Public Company Accounting Oversight Board;

“PFIC” means a “passive foreign investment company” for U.S. federal income tax purposes;

“Plan of First Merger” means the plan of merger for the First Merger between Summit and Merger Sub I;

“Plan of Second Merger” means the plan of merger for the Second Merger between the Surviving Entity and Merger Sub II;

“Pre Consolidation YS Biopharma Ordinary Shares” means the ordinary share of YS Biopharma prior to the YS Biopharma Share Consolidation;

- “Proposals” means the Business Combination Proposal, the Merger Proposal and the Adjournment Proposal;
- “Record Date” means February 2, 2023;
- “Redeeming Summit Shares” means Summit Shares in respect of which the eligible (as determined in accordance with the amended and restated memorandum and articles of association of Summit) holder thereof has validly exercised (and not validly revoked, withdrawn or lost) his, her or its Summit Shareholder Redemption right;
- “Redemption Rate” means a fraction, expressed as a percentage, (i) the numerator of which is the aggregate number of Redeeming Summit Shares and (ii) the denominator of which is the aggregate number of Summit Shares in respect of which the holder thereof is eligible (as determined in accordance with the Summit Articles) to exercise his, her or its Redemption rights;
- “Sarbanes-Oxley Act” means the Sarbanes-Oxley Act of 2002, as amended;
- “SEC” means the U.S. Securities and Exchange Commission;
- “Second Merger” means the merger between the Surviving Entity and Merger Sub II, with Merger Sub II being the surviving entity and remaining as a wholly-owned subsidiary of YS Biopharma;
- “Securities Act” means the U.S. Securities Act of 1933, as amended;
- “Shareholder Support Agreement” means the shareholder support agreement and deed, dated September 29, 2022, by and among YS Biopharma, Summit, and the Supporting Shareholders;
- “Shareholders Agreement” means the Shareholders Agreement in respect of YS Biopharma, dated as of January 28, 2021, as may be amended and/or restated from time to time;
- “Singapore Yisheng” means Yisheng Biopharma (Singapore) Pte. Ltd., (formerly known as Newbiomed Pika Pte. Ltd.), a company incorporated under the laws of Singapore and a wholly-owned subsidiary of YS Biopharma;
- “Sponsor” means Summit Healthcare Acquisition Sponsor LLC, a limited liability company registered under the laws of the Cayman Islands;
- “Summit” means Summit Healthcare Acquisition Corp., an exempted company limited by shares incorporated under the laws of the Cayman Islands;
- “Summit Articles” means Summit’s amended and restated memorandum and articles of association adopted by special resolution dated June 8, 2021;
- “Summit Board” means the board of directors of Summit;
- “Summit Class A Exchange Ratio” or “Class A Exchange Ratio” means a ratio equal to (i) if the Redemption Rate is less than or equal to 85%, the quotient obtained by *dividing* (a) the sum of (x) 2,732,325 and (y) the aggregate number of Non-Redeeming Summit Shares *by* (b) the aggregate number of Non-Redeeming Summit Shares, rounded up to the nearest four decimal points and (ii) if the Redemption Rate is more than 85%, 1.4286 (it being understood that the Summit Class A Exchange Ratio is between 1.1169 and 1.4286, depending on the Redemption Rate);
- “Summit Class A Ordinary Shares” or “Summit Public Shares” means Class A ordinary shares of Summit, par value \$0.0001 per share, as further described in the Summit Articles, prior to the First Merger Effective Time, and for the avoidance of doubt, there shall be no Summit Class A Ordinary Shares after the First Merger Effective Time;
- “Summit Class B Ordinary Shares” or “Founder Shares” means Class B ordinary shares of Summit, par value \$0.0001 per share, as further described in the Summit Articles, prior to the First Merger Effective Time, and for the avoidance of doubt, there shall be no Summit Class B Ordinary Shares after the First Merger Effective Time;

“Summit Ordinary Shares” or “Summit Shares” means, collectively, Summit Class A Ordinary Shares and Summit Class B Ordinary Shares, prior to the First Merger Effective Time, and for the avoidance of doubt, there shall be no Summit Ordinary Shares after the First Merger Effective Time;

“Summit Private Warrants” means the warrants sold to the Sponsor in the private placement consummated concurrently with the IPO, each entitling its holder to purchase one Summit Public Share at an exercise price of \$11.50 per share, subject to adjustment;

“Summit Public Shareholder” means a holder of Summit Public Shares issued as part of the Units issued in the IPO;

“Summit Public Warrants” means the redeemable warrants issued in the IPO, each entitling its holder to purchase one Summit Public Share at an exercise price of \$11.50 per share, subject to adjustment;

“Summit Warrants” means the Summit Public Warrants and the Summit Private Warrants;

“Summit Shareholder Redemption Amount” means the aggregate amount payable with respect to all Redeeming Summit Shares;

“Summit Shareholder Redemption Right” means the right of an eligible (as determined in accordance with the Summit Articles) holder of Summit Shares to redeem all or a portion of the Summit Shares held by such holder as set forth in the Summit Articles in connection with the Proposals;

“Summit Shareholders” means the holders of Summit Shares;

“Supporting Shareholders” means that certain shareholders of YS Biopharma and certain shareholders of Summit who entered into the Shareholders Support Agreement;

“Surviving Entity” means Summit after the consummation of the First Merger;

“Surviving Company” means Merger Sub II after the consummation of the Second Merger;

“Trust Account” means the trust account of Summit that holds the proceeds from the IPO and the sale of the Summit Private Warrants;

“Units” means the units issued in the IPO, each consisting of one Summit Public Share and one-half of one Summit Public Warrant;

“U.S. Dollars” or “\$” means United States dollars, the legal currency of the United States;

“U.S. GAAP” means generally accepted accounting principals in the United States as in effect from time to time;

“US Yisheng” means Yisheng US Biopharma Inc., a company incorporated under the laws of U.S. and a wholly-owned subsidiary of YS Biopharma;

“VAT” means the value added tax;

“YS Biopharma” means YishengBio Co., Ltd, an exempted company with limited liability incorporated under the laws of the Cayman Islands, which will be renamed as YS Biopharma Co., Ltd prior to the Closing;

“YS Biopharma Capital Restructuring” means YS Biopharma Share Conversion and YS Biopharma Share Consolidation;

“YS Biopharma Ordinary Share” means (i) before YS Biopharma Capital Restructuring, ordinary shares of YS Biopharma, par value \$0.000005 per share, (ii) after YS Biopharma Capital Restructuring but before the First Merger Effective Time, ordinary shares of YS Biopharma, par value \$0.00002 per share, the rights, preferences, privileges and restrictions of which are as set out in YS Biopharma Articles and (iii) from and after the First Merger Effective Time, ordinary shares of YS Biopharma, par value \$0.00002 per share, the rights, preferences, privileges and restrictions of which are as set out in the Amended YS Biopharma Articles;

“YS Biopharma Share Consolidation” means the consolidation of every four Pre Consolidation YS Biopharma Ordinary Shares and options of YS Biopharma into one YS Biopharma Ordinary Share and one option of YS Biopharma, respectively, subject to rounding up to the nearest whole number of shares;

“YS Biopharma Share Conversion” means the conversion of each preferred shares of YS Biopharma into one Pre Consolidation YS Biopharma Ordinary Shares;

“YS Biopharma Warrant” means warrant to purchase YS Biopharma Ordinary Share after the Closing, with each whole warrant entitling the holder to purchase one YS Biopharma Ordinary Share; and

“YS Group” means YS Biopharma, together as a group with its subsidiaries, including Merger Sub I, Merger Sub II, US Yisheng, Singapore Yisheng and HK Yisheng, Liaoning Yisheng and Beijing Yisheng.

## QUESTIONS AND ANSWERS ABOUT THE PROPOSALS

*The following questions and answers are intended to highlight only selected information from this document and only briefly address some commonly asked questions about the proposals to be presented at the Extraordinary General Meeting, including with respect to the proposed Business Combination. Please refer to the section titled "Summary" and the more detailed information contained elsewhere in this proxy statement/prospectus, the annexes to this proxy statement/prospectus and the documents referred to in this proxy statement/prospectus, which you should read carefully and in their entirety.*

**Q: Why am I receiving this proxy statement/prospectus?**

A: Summit is sending these materials to Summit Shareholders to vote on the Business Combination and related proposals at the Extraordinary General Meeting, which will be held at 9:00 a.m. Eastern Time, on March 1, 2023 at 35th Floor, Two Exchange Square, 8 Connaught Place Central, Hong Kong and virtually at <https://www.cstproxy.com/summithealthcarespac/2023>.

Summit and YS Biopharma have agreed to the Business Combination under the terms of the Business Combination Agreement, a copy of which is included as **Annex A** to this proxy statement/prospectus. The Business Combination Agreement provides for, among other things, (i) the merger of Merger Sub I, with and into Summit, with Summit surviving the First Merger as the Surviving Entity and becoming a wholly-owned subsidiary of YS Biopharma, and (ii) the merger of the Surviving Entity with and into Merger Sub II, with Merger Sub II surviving the Second Merger as the Surviving Company and remaining as a wholly-owned subsidiary of YS Biopharma, and each of the current security holders of Summit receiving securities of YS Biopharma, which will become a public company following the Business Combination.

This document constitutes both a proxy statement of Summit and a prospectus of YS Biopharma. It is a proxy statement because Summit is soliciting proxies from its shareholders. It is a prospectus because YS Biopharma will issue its ordinary shares, par value \$0.00002 per share, in connection with the Business Combination if the Business Combination is completed.

**Q: What proposals are Summit Shareholders being asked to vote upon?**

A: At the Extraordinary General Meeting, Summit is asking Summit Shareholders to consider and vote upon the following proposals:

- The Business Combination Proposal to approve and authorize the Business Combination Agreement and the Business Combination and the other transactions contemplated thereby;
- The Merger Proposal to approve and authorize the First Merger and the Plan of First Merger (being presented to Summit Shareholders separately in light of Cayman Islands law requirements and for good governance practices); and
- The Adjournment Proposal to approve the adjournment of the Extraordinary General Meeting for the purpose of, among others, soliciting additional proxies in favor of the approval of the Business Combination in the event Summit does not receive the requisite shareholder vote to approve the Business Combination.

The vote of Summit Shareholders is important. Summit Shareholders are encouraged to submit their completed proxy card as soon as possible after carefully reviewing this proxy statement/prospectus.

**Q: What vote is required to approve the proposals presented at the Extraordinary General Meeting?**

A: The following votes are required for each proposal at the Extraordinary General Meeting:

- **Proposal No. 1—Business Combination Proposal**—The approval of the Business Combination Proposal will require an ordinary resolution under Cayman Islands law and the Summit Articles, being the affirmative vote of the holders of a majority of the issued and outstanding Summit Shares present in person physically or by virtual attendance or represented by proxy and entitled to vote at the Extraordinary General Meeting.

- **Proposal No. 2—Merger Proposal**—The approval of the Merger Proposal will require a special resolution under Cayman Islands law and the Summit Articles, being the affirmative vote of the holders of at least two-thirds of the issued and outstanding Summit Shares present in person physically or by virtual attendance or represented by proxy and entitled to vote at the Extraordinary General Meeting.
- **Proposal No. 3—Adjournment Proposal**—The approval of the Adjournment Proposal, if presented, will require an ordinary resolution under Cayman Islands law and the Summit Articles, being the affirmative vote of the holders of a majority of the issued and outstanding Summit Shares present in person physically or by virtual attendance or represented by proxy and entitled to vote at the Extraordinary General Meeting.

If you are a Summit Shareholder that attends the Extraordinary General Meeting and fails to vote on the Business Combination Proposal, the Merger Proposal or the Adjournment Proposal, or if you respond to such Proposals with an “abstain” vote, your failure to vote or “abstain” vote in each case will, with respect to a particular Proposal, be counted as present for the purposes of determining whether a quorum is present at the Extraordinary General Meeting, but will have the same effect as a vote “against” such Proposal. Brokers are not entitled to vote on the Business Combination Proposal, the Merger Proposal or the Adjournment Proposal absent voting instructions from the beneficial holder. An abstention or broker non-vote will be counted towards the quorum requirement but will not count as a vote cast at the Extraordinary General Meeting.

**Q: Are any of the Proposals conditioned on one another?**

A: Yes. Each of the Business Combination Proposal and the Merger Proposal (collectively, “Condition Precedent Proposals”) is conditioned on the approval and adoption of the other Condition Precedent Proposal. The Adjournment Proposal (collectively with the Condition Precedent Proposals, the “Proposals”) is not conditioned upon the approval of any other Proposal.

**Q: Why is Summit providing Summit Shareholders with the opportunity to vote on the Business Combination?**

A: Pursuant to the Summit Articles, Summit is required to provide Summit Public Shareholders with an opportunity to have their Summit Public Shares redeemed for cash upon the consummation of its initial business combination, either in conjunction with a shareholder vote or tender offer. Due to the structure of the Business Combination, Summit is providing this opportunity in conjunction with a shareholder vote.

**Q: Why is Summit proposing the Business Combination?**

A: Summit was incorporated for the purpose of effecting a merger, share exchange, asset acquisition, share purchase, reorganization or similar business combination with one or more businesses.

Based on its due diligence investigations of YS Biopharma and the industries in which it operates, including the financial and other information provided by YS Biopharma in the course of Summit’s due diligence investigations, the Summit Board believes that the Business Combination with YS Biopharma is in the best interests of Summit and presents an opportunity to increase shareholder value. However, there can be no assurances of this. Although the Summit Board believes that the Business Combination with YS Biopharma presents a unique business combination opportunity and is in the best interests of Summit, the Summit Board did consider certain potentially material negative factors in arriving at that conclusion. See “The Business Combination Proposal—The Summit Board’s Reasons for the Approval of the Business Combination” for a discussion of the factors considered by the Summit Board in making its decision.

**Q: Did the Summit Board obtain a third-party valuation or fairness opinion in determining whether or not to proceed with the Business Combination?**

A: Yes. The Summit Board received a fairness opinion from ValueScope, Inc. (“ValueScope”), as to the fairness, from a financial point of view, to Summit Shareholders as a group (as opposed to only the Summit Shareholders unaffiliated with the Sponsor or its affiliates), of the consideration to be paid by Summit pursuant to the Business Combination Agreement. For more information, see the section entitled



“The Business Combination Proposal — Summary of Valuation Analysis and Opinion of Financial Advisor to the Summit Board” and the opinion of ValueScope, a copy of which is included as **Annex D** to this proxy statement/prospectus.

**Q: What is expected to happen in the Business Combination?**

A: Subject to, and in accordance with the terms and conditions set forth in the Business Combination Agreement, (i) Merger Sub I will merge with and into Summit, with Summit surviving the First Merger as the Surviving Entity and becoming a wholly-owned subsidiary of YS Biopharma; and (ii) following the First Merger, the Surviving Entity will merge with and into Merger Sub II, with Merger Sub II surviving the Second Merger as the Surviving Company and remaining as a wholly owned subsidiary of YS Biopharma. YS Biopharma will become the parent/public company following the Business Combination.

Subject to, and in accordance with the terms and conditions set forth in the Business Combination Agreement, immediately prior to the First Merger Effective Time, (i) each YS Biopharma Preferred Share will be converted into one Pre Consolidation YS Biopharma Ordinary Share; (ii) every four Pre Consolidation YS Biopharma Ordinary Shares and options of YS Biopharma will be consolidated into one YS Biopharma Ordinary Share and one option of YS Biopharma, respectively, subject to rounding up to the nearest whole number of shares; and (iii) the amended and restated memorandum and articles of association of YS Biopharma shall be adopted and become effective. Items (i) through (iii) are collectively referred to as the “YS Biopharma Capital Restructuring.”

Subject to, and in accordance with the terms and subject to the conditions set forth in the Business Combination Agreement, following completion of the YS Biopharma Capital Restructuring and immediately prior to the First Merger Effective Time, (i) each of the Units (each consisting of one Summit Class A Ordinary Share and one-half of one redeemable Summit Warrant included as part of a Unit) issued and outstanding immediately prior to the First Merger Effective Time shall be automatically detached and the holder thereof shall be deemed to hold one Summit Class A Ordinary Share and one-half of a Summit Warrant (the “Unit Separation”); (ii) each Summit Class A Ordinary Share (including Summit Class A Ordinary Shares held by Summit’s public shareholders as a result of the Unit Separation and Summit Class A Ordinary Shares to be issued pursuant to the Forward Purchase Subscriptions) issued and outstanding immediately prior to the First Merger Effective Time (other than any treasury Summit Shares, redeeming Summit Shares and dissenting Summit Shares) shall automatically be cancelled and cease to exist in exchange for the right to receive such fraction of newly issued YS Biopharma Ordinary Shares after the YS Biopharma Capital Restructuring that is equal to the Summit Class A Exchange Ratio, without interest; (iii) an aggregate of 1,446,525 Summit Class B Ordinary Shares held by Sponsor will be surrendered for nil consideration, and after such surrender, each of the remaining Summit Class B Ordinary Shares held by Sponsor and the independent directors of Summit issued and outstanding immediately prior to the First Merger Effective Time shall automatically be cancelled and cease to exist in exchange for the right to receive one newly issued YS Biopharma Ordinary Share; (iv) each Summit Class B Ordinary Share held by a Forward Purchase Investor and its permitted transferees issued and outstanding immediately prior to the First Merger Effective Time shall automatically be cancelled and cease to exist in exchange for the right to receive (a) such fraction of newly issued YS Biopharma Ordinary Shares that is equal to the Summit Class A Exchange Ratio, without interest, if and only if such Forward Purchase Investor has fully delivered its portion of the Forward Purchase Investment Amount as required under the applicable Forward Purchase Agreement and, failing that, (b) one newly issued YS Biopharma Ordinary Share; and (v) each whole Summit Warrant outstanding immediately prior to the First Merger Effective Time shall cease to be a warrant with respect to Summit Shares and be assumed by YS Biopharma and converted into a warrant to purchase one YS Biopharma Ordinary Share, subject to substantially the same terms and conditions prior to the First Merger Effective Time. No fractional shares or warrants will be issued in the foregoing process, and all such shares or warrants would be rounded down to the nearest whole number of shares or warrants.

In addition, upon the consummation of the First Merger, (i) if there are any Summit Shares that are owned by Summit as treasury shares or any Summit Shares owned by any direct or indirect subsidiary of Summit immediately prior to the First Merger Effective Time, such Summit Shares shall be canceled and shall cease to exist without any conversion thereof or payment or other consideration therefor; (ii) each

Redeeming Summit Share issued and outstanding immediately prior to the First Merger Effective Time shall be cancelled and cease to exist and shall thereafter represent only the right to be paid a pro rata share of the Summit Shareholder Redemption Amount in accordance with Summit's amended and restated memorandum and articles of association; and (iii) each Dissenting Summit Share issued and outstanding immediately prior to the First Merger Effective Time held by a Dissenting Summit Shareholder shall be cancelled and cease to exist and shall thereafter represent only the right to be paid the fair value of such Dissenting Summit Share and such other rights as are granted by the Cayman Islands Companies Act. For more information on the First Merger and the Second Merger, see the sections entitled "The Business Combination Proposal" and "The Merger Proposal." For more information on YS Biopharma's securities upon consummation of the Business Combination, see the section entitled "Description of YS Biopharma Securities — Ordinary Shares."

Prior to the IPO, Summit entered into the Forward Purchase Agreements with each of the Forward Purchase Investors. The Forward Purchase Agreements provide for (i) the transfer of an aggregate of 375,000 Founder Shares from the Sponsor to the Forward Purchase Investors for nil cash consideration prior to the IPO and (ii) the purchase by the Forward Purchase Investors of an aggregate of 3,000,000 Summit Class A Ordinary Shares, plus an aggregate of 750,000 redeemable warrants to purchase Summit Class A Ordinary Shares at \$11.50 per share, for an aggregate purchase price of \$30,000,000 in a private placement to close concurrently with the closing of Summit's initial business combination, which will be the consummation of the Business Combination. The Forward Purchase Investors' subscription obligations under the Forward Purchase Agreements do not depend on whether any Summit Class A Ordinary Shares are redeemed by the Summit Public Shareholders. Proceeds received from the Forward Purchase Investors under the Forward Purchase Agreements will count towards the Available Closing Cash Amount (as defined in the Business Combination Agreement), which is required to be not less than \$30,000,000 under the Business Combination Agreement. The Forward Purchase Investors have also agreed to vote all Summit Shares held by them in favor of the Business Combination if Summit seeks shareholder approval of such transaction.

**Q: Who is YS Biopharma?**

A: YS Group is a fully integrated innovative biotechnology platform. It discovers, develops, manufactures and commercializes new generations of vaccines and therapeutic biologics for infectious diseases and cancer with huge unmet demand, across multiple operational locations, including China, the United States and Singapore. YS Biopharma is a biopharmaceutical company with innovative technology and a revenue-generating marketed product of YSJA™ rabies vaccine with robust growth potential in China. In the fiscal year of 2021 and 2022, YS Group has sold approximately 3.6 million and 6.9 million doses of YSJA™ rabies vaccines to approximately 1440 county-level CDC customers in China, respectively. YS Biopharma has also developed its proprietary PIKA immunomodulating technology platform, empowering a diverse pipelines of innovative vaccines and therapeutic biologics. As of June 30, 2022, YS Group had four product candidates at various clinical trial stages, including PIKA rabies vaccine, PIKA recombinant COVID-19 vaccine, PIKA YS-ON-001 and PIKA YS-HBV-001, and four preclinical stage product candidates, targeting HBV, influenza, rabies and cancer with significant unmet medical needs. In addition, YS Biopharma is working on a series of therapeutic targets and products at the discovery stage. For more information, see the section entitled "YS Biopharma's Business."

YS Biopharma was incorporated under the laws of Cayman Islands as an exempted company with limited liability in November 2020. The history of YS Group can be traced back to 2002 when Mr. Yi Zhang, its founder and controlling shareholder started the vaccine business in the PRC, and has expanded its international business operation in the United States and Singapore since 2009.

**Q: What shall be the relative equity stakes of Summit Shareholders, YS Biopharma shareholders immediately after the consummation of the Business Combination?**

A: Upon consummation of the Business Combination, YS Biopharma will become a public company. The former securityholders of Summit will become securityholders of YS Biopharma. It is anticipated that, upon completion of the Business Combination, the ownership and voting power of YS Biopharma Ordinary Shares as well as the Sponsor and its affiliates' total potential ownership interest in YS Biopharma will be as set forth in the tables below, assuming no redemption, 50% redemption and 100%

redemption. The share amounts and ownership and voting power percentages set forth in the tables below do not take into account (i) warrants that will remain outstanding immediately following the Business Combination and may be exercised thereafter to acquire YS Biopharma Ordinary Shares and (ii) any outstanding options or restricted share units that were assumed by YS Biopharma upon the completion of the Business Combination. If the actual facts are different from the foregoing assumptions, the share amounts and percentage ownership numbers set forth below will be different.

	Scenario 1 Assuming No Redemption		Scenario 2 Assuming 50% Redemption		Scenario 3 Assuming 100% Redemption	
	Number of Ordinary Shares	Share Ownership %	Number of Ordinary Shares	Share Ownership %	Number of Ordinary Shares	Share Ownership %
YS Biopharma Shareholders	83,424,995	73.53	83,424,995	80.63	83,424,995	90.51
Summit Public Shareholders	22,337,818	19.69	12,042,860	11.64	—	—
Forward Purchase Investors	3,769,507	3.32	4,064,465	3.93	4,821,525	5.23
Sponsor and certain Summit directors as a group	3,928,475	3.46	3,928,475	3.80	3,928,475	4.26
<b>Pro Forma Ordinary Shares Outstanding<sup>(1)</sup></b>	<u>113,460,795</u>	<u>100.00</u>	<u>103,460,795</u>	<u>100.00</u>	<u>92,174,995</u>	<u>100.00</u>
Pro Forma Book Value of Equity	RMB2,234,552,988		RMB1,520,312,246		RMB806,071,503	
<b>Pro Forma Book Value per Share</b>	<u>RMB19.69</u>		<u>RMB14.69</u>		<u>RMB8.75</u>	

- (1) Includes YS Biopharma Ordinary Shares to be held by existing YS Biopharma shareholders and YS Biopharma Ordinary Shares to be issued to non-redeeming Summit Shareholders and Forward Purchase Investors upon completion of the Business Combination, but excludes 10,000 YS Biopharma Ordinary Shares to be issued as part of advisory fees to YS Biopharma's financial advisor.

Shareholders will experience additional dilution to the extent YS Biopharma issues additional shares after the Closing. The table above excludes up to 6,656,582 YS Biopharma Ordinary Shares that will be available for issuance under the YS Biopharma 2022 Plan. The following table illustrates the impact on relevant ownership and voting power levels assuming the issuance of all such shares.

	Scenario 1 Assuming No Redemption		Scenario 2 Assuming 50% Redemption		Scenario 3 Assuming 100% Redemption	
	Number of Ordinary Shares	Share Ownership %	Number of Ordinary Shares	Share Ownership %	Number of Ordinary Shares	Share Ownership %
YS Biopharma Shareholders	90,081,577	74.99	90,081,577	81.80	90,081,577	91.15
Summit Public Shareholders	22,337,818	18.60	12,042,860	10.94	—	—
Forward Purchase Investors	3,769,507	3.14	4,064,465	3.69	4,821,525	4.88
Sponsor and certain Summit directors as a group	3,928,475	3.27	3,928,475	3.57	3,928,475	3.97
<b>Pro Forma Ordinary Shares Outstanding</b>	<b>120,117,377</b>	<b>100.00</b>	<b>110,117,377</b>	<b>100.00</b>	<b>98,831,577</b>	<b>100.00</b>
Pro Forma Book Value of Equity	RMB2,250,791,944		RMB1,536,551,202		RMB822,310,459	
<b>Pro Forma Book Value per Share</b>	<b>RMB18.74</b>		<b>RMB13.95</b>		<b>RMB8.32</b>	

For additional informational purposes, the following table sets forth both (i) the Sponsor's ownership interest, and (ii) the Sponsor's total potential ownership interest in YS Biopharma upon consummation of the Business Combination, assuming no redemption, 50% redemption and 100% redemption.

	Scenario 1 Assuming No Redemption			Scenario 2 Assuming 50% Redemption			Scenario 3 Assuming 100% Redemption		
	Number of Ordinary Shares	Share Ownership %		Number of Ordinary Shares	Share Ownership %		Number of Ordinary Shares	Share Ownership %	
		(A)	(B)		(A)	(B)		(A)	(B)
Sponsor <sup>(1)</sup>	3,853,475	3.40	3.21	3,853,475	3.72	3.5	3,853,475	4.18	3.9
Sponsor's total potential ownership interest <sup>(2)</sup>	11,353,475	9.39	8.9	11,353,475	10.23	9.65	11,353,475	11.39	10.68

(A) Excludes up to 6,656,582 YS Biopharma Ordinary Shares that will be available for issuance under the YS Biopharma 2022 Plan.

(B) Includes up to 6,656,582 YS Biopharma Ordinary Shares that will be available for issuance under the YS Biopharma 2022 Plan.

(1) Represents 3,853,475 YS Biopharma Ordinary Shares to be received by the Sponsor for the 5,750,000 Summit Class B Ordinary Shares held by the Sponsor.

(2) Represents (i) 3,853,475 YS Biopharma Ordinary Shares to be received by the Sponsor for the 5,750,000 Summit Class B Ordinary Shares held by the Sponsor, (ii) 6,000,000 YS Biopharma Ordinary Shares issuable upon conversion of 6,000,000 YS Biopharma Warrants to be received by the Sponsor for the 6,000,000 Summit Private Warrants held by the Sponsor, and (iii) 1,500,000 YS Biopharma Ordinary Shares issuable upon conversion of 1,500,000 YS Biopharma Warrants to be received by the Sponsor for the 1,500,000 Summit Private Warrants issuable under the convertible promissory note issued in September 2022. For a more detailed description of the convertible promissory note, see "Certain Relationships and Related Person Transactions." The Sponsor does not have any affiliates that hold potential ownership interest in YS Biopharma upon consummation of the Business Combination.

The underwriters are not entitled to deferred compensation upon the closing of the Business Combination.

For a more detailed description of share ownership upon consummation of the Business Combination, see the section entitled "Beneficial Ownership of Securities."

**Q: Who will be the officers and directors of YS Biopharma if the Business Combination is consummated?**

A: It is anticipated that, at the Closing, YS Biopharma’s board of directors will be comprised of seven directors who will be identified and appointed prior to the Closing. YS Biopharma’s executive management team will be led by the current management of YS Biopharma. Mr. Bo Tan will be a member of YS Biopharma’s board of directors upon the consummation of the Business Combination. The other six directors have been identified in the section titled “Management Following the Business Combination.”

**Q: What are the U.S. federal income tax consequences of the Mergers to U.S. Holders of Summit Public Shares and/or Summit Public Warrants?**

A: As described in the section of this proxy statement/prospectus entitled “Material Tax Considerations — U.S. Federal Income Tax Considerations to U.S. Holders — Tax Treatment of the Mergers,” to qualify as a “reorganization” within the meaning of Section 368(a) of the Code (a “Reorganization”), the Mergers must satisfy certain requirements, some of which are based on factual determinations, and actions or events after the Mergers could adversely affect such qualification. One such requirement is that the acquiring corporation, directly or indirectly through certain controlled corporations, either continue a significant line of the acquired corporation’s historic business or use a significant portion of the acquired corporation’s historic business assets in a business, in each case, within the meaning of U.S. Treasury Regulations Section 1.368-1(d). However, due to the absence of guidance bearing directly on how the above rules apply in the case of an acquisition of a corporation like Summit that holds primarily investment-type assets, the qualification of the Mergers as a Reorganization is subject to significant uncertainty, and is therefore not capable of being the subject of a representation regarding its tax treatment. The closing of the Business Combination is not conditioned upon the receipt of an opinion of counsel that the Mergers will qualify as a Reorganization, and neither Summit nor YS Biopharma intends to request a ruling from the U.S. Internal Revenue Service (the “IRS”) regarding the U.S. federal income tax treatment of the Mergers. Accordingly, no assurance can be given that the IRS will not treat the Mergers as taxable transactions and challenge the qualification of the Mergers as a Reorganization or that a court will not sustain such a challenge by the IRS. U.S. Holders of Summit Securities are urged to consult their tax advisors regarding the proper U.S. federal income tax treatment of the Mergers, including with respect to their qualification as a Reorganization.

If the Mergers were to qualify as a Reorganization, a U.S. Holder (as defined in the section entitled “Material Tax Considerations — U.S. Federal Income Tax Considerations to U.S. Holders”) generally would not recognize gain or loss on the exchange of Summit Securities for YS Biopharma Securities in the Mergers. However, if any requirement to qualify as a Reorganization is not met, then a U.S. Holder generally will recognize gain or loss in an amount equal to the difference between the fair market value (as of the closing date of the Mergers) of YS Biopharma Ordinary Shares and YS Biopharma Warrants received in the Merger, over such holder’s aggregate adjusted tax basis in the corresponding Summit Public Shares and Summit Public Warrants surrendered by such holder in the Mergers. Even if the requirements to qualify as a Reorganization are satisfied, U.S. Holders may be required to recognize gain (but not loss) in the Mergers under the PFIC rules, as described in more detail in the section entitled “Material Tax Considerations — U.S. Federal Income Tax Considerations — Passive Foreign Investment Company Rules.”

The tax consequences of the Mergers are complex and will depend on each U.S. Holder’s particular circumstances. For a more detailed discussion of the U.S. federal income tax considerations of the Mergers for U.S. Holders, see the section entitled “Material Tax Considerations — U.S. Federal Income Tax Considerations to U.S. Holders — Tax Treatment of the Mergers.” U.S. Holders exchanging their Summit Public Shares and/or Summit Public Warrants in the Mergers should consult their tax advisors to determine the tax consequences thereof.

**Q: What are the U.S. federal income tax consequences of exercising my redemption rights?**

A: If a U.S. Holder elects to redeem its Summit Public Shares for cash, the treatment of the transaction for U.S. federal income tax purposes will depend on whether the redemption qualifies as a sale or exchange of the Summit Public Shares under Section 302 of the Code. If the redemption qualifies as such a sale or

exchange, such U.S. Holder generally will recognize gain or loss in an amount equal to the difference, if any, between the amount realized on the redemption and such U.S. Holder's adjusted tax basis in the Summit Public Shares surrendered by such U.S. Holder in the redemption. There may be certain circumstances, however, in which the redemption may be treated as a distribution for U.S. federal income tax purposes, depending on the amount of Summit Public Shares that such Holder owns or is deemed to own (including through the ownership of Summit Public Warrants) after the redemption. For more information, see the section entitled "Material Tax Considerations — U.S. Federal Income Tax Considerations to U.S. Holders — Redemption of Summit Public Shares". U.S. Holders are urged to consult their tax advisors regarding the tax consequences of exercising their redemption rights.

**Q: What conditions must be satisfied to complete the Business Combination?**

A: There are a number of closing conditions to the Business Combination, including, but not limited to, the following:

- the effectiveness of this Form F-4 and the absence of any issued or pending stop order by the SEC;
- approval of the Business Combination Proposal by way of ordinary resolution and the Merger Proposal by way of special resolution by the Summit Shareholders;
- receipt of approval for YS Biopharma Ordinary Shares and YS Biopharma Warrants to be listed on Nasdaq, subject only to official notice of issuance;
- the Available Closing Cash Amount (as defined in the Business Combination Agreement) being not less than \$30 million;
- the absence of any Company Material Adverse Effect (as defined in the Business Combination Agreement);
- the absence of any SPAC Material Adverse Effect (as defined in the Business Combination Agreement);
- the waiver of deferred underwriting fee by the underwriter for the IPO has not been withdrawn; and
- the absence of any law (whether temporary, preliminary or permanent) or governmental order then in effect and which has the effect of making the Closing illegal or which otherwise prevents or prohibits the consummation of the Closing (any of the foregoing, a "restraint"), other than any such restraint that is immaterial.

For a summary of all of the conditions that must be satisfied or waived prior to completion of the Business Combination, see the section entitled "The Business Combination Agreement."

**Q: Who can vote at the Extraordinary General Meeting?**

A: Only Summit Shareholders who held Summit Share of record as of the close of business on February 2, 2023, the "Record Date" for the Extraordinary General Meeting, are entitled to receive notice of and to vote at the Extraordinary General Meeting. As of the close of business on the Record Date, there were 20,000,000 Summit Public Shares and 5,750,000 Founder Shares outstanding and entitled to vote.

**Q: What constitutes a quorum at the Extraordinary General Meeting?**

A: A quorum shall be present at the Extraordinary General Meeting if one or more shareholders holding not less than one-third of the issued and outstanding Summit Shares present in person physically or by virtual attendance or represented by proxy and entitled to vote at the Extraordinary General Meeting. If a quorum is not present within half an hour from the time appointed for the Extraordinary General Meeting to commence or if during the meeting a quorum ceases to be present, the meeting shall stand adjourned to the same day in the next week at the same time and place or to such other day, time and/or place as the directors of Summit may determine, and if at the adjourned meeting a quorum is not present within half an hour from the time appointed for the meeting to commence, the Summit Shareholders present shall be a quorum.

As of the Record Date, 8,583,334 Summit Shares would be required to achieve a quorum.

**Q: How many votes do I have at the Extraordinary General Meeting?**

A: Summit Shareholders are entitled to one vote at the Extraordinary General Meeting for each Summit Share held of record as of close of business on the Record Date.

**Q: How do holders of Summit's Founder Shares intend to vote on the proposals?**

A: Holders of the Founder Shares beneficially own and are entitled to vote an aggregate of approximately 22.3% of the outstanding Summit Shares. These holders are required by certain agreements to vote their shares in favor of the Business Combination Proposal, the Merger Proposal and the Adjournment Proposal, if presented at the Extraordinary General Meeting.

**Q: What interests do Summit's Directors and Officers have in the Business Combination?**

A: When considering the Summit Board's recommendation to vote in favor of the Business Combination Proposal and the Merger Proposal, Summit Shareholders should keep in mind that Sponsor and Summit's directors and officers have interests in such Proposals that are different from, or in addition to (and which may conflict with), those of Summit Shareholders and warrant holders generally.

These interests include, among other things, the interests listed below:

- the fact that the Sponsor and Summit's directors and officers have agreed to waive their redemption rights with respect to their Summit Class B Ordinary Shares in connection with the completion of the Business Combination;
- the fact that the Sponsor and certain of Summit's directors are anticipated to hold 3.46% of the equity interest and 3.46% of the voting power in YS Biopharma immediately after the Business Combination, assuming no redemptions by Summit Public Shareholders and there are no Dissenting Summit Shareholders (or 4.26% of the equity interest and 4.26% of the voting power in YS Biopharma immediately after the Business Combination, assuming 100% redemption by Summit Public Shareholders);
- the fact that the Sponsor paid an aggregate of \$25,000 for the 5,750,000 Founder Shares currently owned by the Sponsor, Summit's independent directors and the Forward Purchase Investors and such securities will have a significantly higher value after the Business Combination. As of February 2, 2023, the most recent practicable date prior to the date of this proxy statement/prospectus, the aggregate market value of these shares, if unrestricted and freely tradable, would be \$58,190,000, based upon a closing price of \$10.12 per Summit Public Share on Nasdaq. The Founder Shares are expected to be worthless if the Business Combination or another business combination is not completed by the Final Redemption Date because the holders are not entitled to participate in any redemption or distribution of proceeds in the Trust Account with respect to such shares;
- the fact that Sponsor paid \$6,000,000 to purchase an aggregate of 6,000,000 Summit Private Warrants, each exercisable to purchase one Summit Class A Ordinary Share at \$11.50, subject to adjustment, at a price of \$1.00 per warrant, and those warrants would be worthless — and the entire \$6,000,000 warrant investment would be lost — if the Business Combination or another business combination is not consummated by the Final Redemption Date. As of February 2, 2023, the most recent practicable date prior to the date of this proxy statement/prospectus, the aggregate market value of these Summit Private Warrants, if unrestricted and freely tradable, would be \$1,664,400, based upon a closing price of \$0.2774 per Summit Public Warrant on Nasdaq;
- the fact that, given the differential in the purchase price that the Sponsor paid for the Founder Shares and the purchase price that the Sponsor paid for the Summit Private Warrants as compared to the price of the Summit Public Shares and Summit Public Warrants and the substantial number of YS Biopharma Ordinary Shares that the Sponsor and Summit's directors will receive upon conversion of the Founder Shares and Summit Private Warrants, the Sponsor and these directors can earn a positive return on their investment, even if other Summit Shareholders have a negative return in their investment in YS Biopharma;
- the fact that Sponsor and Summit's directors and officers have agreed to waive their rights to liquidating distributions from the Trust Account with respect to any Founder Shares held by them if Summit fails to complete a business combination by the Final Redemption Date;

- the fact that the Business Combination Agreement provides for continued indemnification of Summit's directors and officers and the continuation of Summit's directors' and officers' liability insurance after the Business Combination (i.e., a "tail policy");
- the fact that Sponsor and Summit's directors and officers and their affiliates are entitled to reimbursement of out-of-pocket expenses incurred by them in connection with certain activities on Summit's behalf, such as identifying and investigating possible business targets and business combinations. However, if Summit fails to consummate a business combination within the required period, they will not have any claim against the Trust Account for reimbursement. Accordingly, Summit may not be able to reimburse these expenses if the Business Combination or another business combination is not completed by the Final Redemption Date. That being said, the Sponsor and Summit's directors and officers and their affiliates had not incurred any unpaid reimbursable expenses as of the date of this proxy statement/prospectus;
- the fact that the Sponsor will benefit from the completion of a business combination and may be incentivized to complete an acquisition of a less favorable target company or on terms less favorable to shareholders rather than liquidate;
- the fact that if the Trust Account is liquidated, including in the event Summit is unable to complete a business combination by the Final Redemption Date, the Sponsor has agreed to indemnify Summit to ensure that the proceeds in the Trust Account are not reduced below \$10.00 per Summit Public Share, or such lesser per Summit Public Share amount as is in the Trust Account on the liquidation date, by the claims of prospective target businesses with which Summit has discussed entering into a transaction agreement or claims of any third party for services rendered or products sold to Summit (other than Summit's independent registered public accounting firm), but only if such a vendor or target business has not executed a waiver of any and all rights to seek access to the Trust Account;
- the fact that the Summit Articles contain a waiver of the corporate opportunity doctrine. With such waiver, there could be business combination targets that may be suitable or worth consideration for a combination with Summit but not offered due to a Summit director's duties to another entity. Summit does not believe that the potential conflict of interest relating to the waiver of the corporate opportunities doctrine in the Summit Articles impacted its search for an acquisition target and Summit was not prevented from reviewing any opportunities as a result of such waiver;
- the fact that HK Yisheng, a subsidiary of YS Biopharma, entered into the Facility Agreement with, among other parties, R-Bridge Investment Three Pte. Ltd, as original lender, and R-Bridge Healthcare Fund L.P., as original agent. Mr. Wei Fu, the Honorary Chairman and Senior Advisor of Summit and one of the managers of the Sponsor, is the sole director of R-Bridge and one of the investment committee members of R-Bridge Fund. Pursuant to the Facility Agreement, (i) R-Bridge made available to YS Biopharma a term loan facility in an aggregate amount of \$40,000,000, all of which was outstanding as of the date hereof; (ii) the facility and commitment under the Facility Agreement will be immediately cancelled and all of the outstanding loans, together with accrued interest and other amounts will become immediately due and payable if a listing, admission to trading, flotation or public offering of any shares of YS Biopharma (including upon or as a result of any direct or indirect merger, consolidation or takeover) has not occurred by October 31, 2023 or a later day as determined under the Facility Agreement; and (iii) consents from the lender(s) whose commitments aggregate more than 2/3 of the total amount then outstanding are required to approve certain transactions, including the Business Combination Agreement; and
- the fact that Mr. Bo Tan, a current director of Summit, is expected to become a director of YS Biopharma and in such case would be compensated as a director of YS Biopharma.

For more information, see the section entitled "The Business Combination Proposal — Interests of Summit's Directors, Officers and the Sponsor in the Business Combination."

**Q: I am a Summit Shareholder. Do I have redemption rights?**

A: Yes. Pursuant to the Summit Articles, in connection with the completion of the Business Combination, Summit Public Shareholders may elect to have their Summit Public Shares redeemed for cash at the applicable redemption price per share calculated in accordance with the Summit Articles. In this proxy



statement/prospectus, these rights to demand redemption of the Summit Public Shares are sometimes referred to as “redemption rights.” For illustrative purposes, as of February 2, 2023, the Record Date, this redemption amount would have amounted to approximately \$10.1 per share. There are currently no owed but unpaid income taxes on the funds in the Trust Account. However, the proceeds deposited in the Trust Account could become subject to the claims of Summit’s creditors, if any, which would have priority over the claims of Summit Shareholders. Therefore, the per share distribution from the Trust Account in such a situation may be less than originally expected due to such claims. It is expected that the funds to be distributed to Summit Public Shareholders electing to redeem their Summit Public Shares shall be distributed promptly after the consummation of the Business Combination. If a Summit Public Shareholder exercises its redemption rights, then such holder shall be exchanging its Summit Public Shares for cash. Such a holder shall be entitled to receive cash for its Summit Public Shares only if it properly demands redemption and delivers its share certificates (if any) or shares (either physically or electronically) to Continental, Summit’s transfer agent, in the manner described in this proxy/registration statement, at least two business days prior to the vote at the Extraordinary General Meeting. A Summit Public Shareholder, together with any affiliate of such holder and any person with whom such holder is acting in concert or as a “group” (as defined under Section 13(d)(3) of the Exchange Act), may not seek to have more than 15% of the aggregate Summit Public Shares redeemed without the prior consent of Summit. Additionally, under the Summit Articles, in no event will Summit redeem Summit Public Shares in an amount that would cause its net tangible assets to be less than \$5,000,001, such that Summit is not subject to the SEC’s “penny stock” rules. In accordance with the Business Combination Agreement, if the cash proceeds from the Trust Account, plus cash proceeds received under the Forward Purchase Agreements, plus any amount raised pursuant to permitted equity financings prior to the Closing (excluding any proceeds that will be invested by existing shareholders or creditors of YS Biopharma immediately prior to the First Merger Effective Time), minus the aggregate amount payable to Summit Public Shareholders exercising their redemption rights, in the aggregate equaling less than \$30 million, the closing condition is not satisfied and therefore, the Business Combination may not be consummated. For the procedures to be followed if you wish to redeem your shares for cash, see the section entitled “Extraordinary General Meeting of Summit Shareholders — Redemption Rights.”

In addition, if a shareholder does not redeem its Summit Public Shares, but other shareholders do elect to redeem their respective Summit Public Shares, the non-redeeming shareholders would own shares with a higher implied value per share. As the percentage of redeeming Summit Public Shares increases (subject to a cap of 85%<sup>(1)</sup>), the Summit Class A Exchange Ratio increases. As the Summit Class A Exchange Ratio increases, the number of YS Biopharma Ordinary Shares issuable in exchange for non-redeeming Summit Public Shares will also increase. For informational purposes only, please see the table below for an illustration of the foregoing paragraph.

Percentage of Redemption <sup>(1)</sup>	0.0%	25.0%	50.0%	75.0%	85.0%	90.0%	100.0%
Percentage of Summit Public Shares Not Redeemed	100%	75%	50%	25%	15%	10%	0%
Remaining Summit Public Shares	20,000,000	15,000,000	10,000,000	5,000,000	3,000,000	2,000,000	0
Assumed Price Per Summit Public Share at Closing of Business Combination (\$)	10.00	10.00	10.00	10.00	10.00	10.00	10.00
Trust Account Size (\$ in millions)	200	150	100	50	30	20	0
Additional YS Biopharma Ordinary Shares Available to Non-Redeeming Summit Public Shareholders	2,337,818	2,230,469	2,042,860	1,631,239	1,285,800	857,200	0
Summit Shares held by Forward Purchase Investors <sup>(2)</sup>	3,375,000	3,375,000	3,375,000	3,375,000	3,375,000	3,375,000	3,375,000
Additional YS Biopharma Ordinary Shares Available to Forward Purchase Investors <sup>(3)</sup>	394,507	501,856	689,465	1,101,086	1,446,525	1,446,525	1,446,525
Class A Exchange Ratio	1.1169	1.1487	1.2043	1.3262	1.4286	1.4286	1.4286
Implied Price Per YS Biopharma Ordinary Shares to be held by Non-Redeeming Summit Public Shareholders (\$) <sup>(4)</sup>	8.95	8.71	8.30	7.54	7.00	7.00	7.00
Implied Price Per YS Biopharma Ordinary Shares to be held by Forward Purchase Investors (\$) <sup>(4)</sup>	7.96	7.74	7.38	6.70	6.22	6.22	6.22
Implied Merger Consideration Per Summit Public Share (\$)	11.17	11.49	12.04	13.26	14.29	14.29	14.29

- (1) The Business Combination Agreement includes a closing condition, which requires that the Available Closing Cash Amount shall be no less than \$30,000,000. The Available Closing Cash Amount is calculated as the sum of: (i) the amount of cash proceeds from the Trust Account, plus (ii) the aggregate amount of cash that has been funded to, or that will be funded immediately prior to or concurrently with the Closing to Summit pursuant to the Forward Purchase Agreements, plus (iii) any amount raised pursuant to permitted equity financings prior to the Closing (excluding any proceeds that will be invested by existing shareholders or creditors of YS Biopharma immediately prior to the First Merger Effective Time), minus (iv) the aggregate amount payable to Summit Public Shareholders exercising their redemption rights. Accordingly, if no more than 85% of the total Summit Public Shares are redeemed, the Available Closing Cash Amount will be no less than \$30,000,000, even if Summit and YS Biopharma do not receive any proceeds pursuant to the Forward Purchase Agreements or raise any other permitted equity financings prior to the Closing. However, even if the actual redemption percentage is higher than 85%, the Business Combination may still be consummated if (i) YS Biopharma waives the Available Closing Cash Amount as a closing condition, or (ii) the post-redemption cash proceeds in the Trust Account, when combined with proceeds received under the Forward Purchase Agreements and/or other permitted equity financings prior to the Closing, are no less than \$30,000,000.
- (2) Represents (i) 3,000,000 Summit Class A Ordinary Shares to be issued to the Forward Purchase Investors pursuant to the Forward Purchase Agreements and (ii) 375,000 Summit Class B Ordinary Shares transferred by the Sponsor to the Forward Purchase Investors in connection with the execution of the Forward Purchase Agreements prior to the IPO.
- (3) If the percentage of redemption exceeds 85%, the additional YS Biopharma Ordinary Share available to the Forward Purchase Investors will be entirely contributed by the Sponsor by way of the surrender of 1,446,525 Summit Class B Ordinary Shares for nil consideration, effective immediately prior to the First Merger Effective Time.
- (4) The implied price per YS Biopharma Ordinary Share to be held by Forward Purchase Investors post consummation of the Business Combination takes into consideration of the 375,000 Summit Class B Ordinary Shares transferred by the Sponsor to the Forward Purchase Investors for nil cash consideration in connection with the execution of the Forward Purchase Agreements prior to the IPO. As a result, the implied price per YS Biopharma Ordinary Share to be held by Forward Purchase Investors is lower than the implied price per YS Biopharma Ordinary Share to be held by non-redeeming Summit Public Shareholders. For the avoidance of doubt, Summit Class A Ordinary Shares were issued at \$10.00 per share to both the Forward Purchase Investor and the Summit Public Shareholder.

For illustrative purposes only, assuming a price of \$10.00 per Summit Public Share at the Closing, non-redeeming shareholders would receive, in exchange for each Summit Public Share held, YS Biopharma Ordinary Shares with a value equating to between \$11.17 (assuming no redemption) and \$14.29 (assuming 85% or higher redemption).

**Q: Will how I vote affect my ability to exercise redemption rights?**

A: No. A Summit Public Shareholder may exercise redemption rights regardless of whether he, she or it votes, “FOR” or “AGAINST” the Business Combination Proposal, the Merger Proposal or the Adjournment Proposal or does not vote on such proposals at all. As a result, the Business Combination Agreement can be approved by shareholders who shall redeem their shares and no longer remain shareholders, leaving shareholders who choose not to redeem their shares holding shares in a company with a potentially less liquid trading market, fewer shareholders and the potential inability to meet the Nasdaq listing standards.

**Q: How do I exercise my redemption rights?**

A: If you are a Summit Public Shareholder and wish to exercise your right to have your Summit Public Shares redeemed, you must:

- submit a written request to Continental, Summit’s transfer agent, in which you (i) request that Summit redeem all or a portion of your Summit Public Shares for cash, and (ii) identify yourself as the beneficial holder of the Summit Public Shares and provide your legal name, phone number and address; and
- either tender your share certificates (if any) to Continental, Summit’s transfer agent, or deliver your Summit Public Shares to the transfer agent electronically using The Depository Trust Company’s DWAC (Deposit/Withdrawal at Custodian) System.

Holders of Summit Public Shares must complete the procedures for electing to redeem their Summit Public Shares in the manner described above prior to 5:00 p.m., Eastern Time, on February 27, 2023, two business days prior to the vote at the Extraordinary General Meeting in order for their Summit Public Shares to be redeemed.

The address of Continental, Summit’s transfer agent, is listed under the question “Who can help answer my questions?” below.

There is a nominal cost associated with the above-referenced tendering process and the act of certificating the shares or delivering them through the DWAC system. The transfer agent will typically charge the tendering broker a nominal amount and it would be up to the broker whether or not to pass this cost on to the redeeming shareholder. In the event the Business Combination is not consummated this may result in an additional cost to shareholders for the return of their shares.

If you hold the Summit Public Shares in “street name,” you will have to coordinate with your broker or bank to have the Summit Public Shares you beneficially own certificated and delivered electronically.

Holders of Units must elect to separate the Units into the underlying Summit Public Shares and Summit Public Warrants prior to exercising redemption rights with respect to the Summit Public Shares. If holders hold their Units in an account at a brokerage firm or bank, holders must notify their broker or bank that they elect to separate the Units into the underlying Summit Public Shares and Summit Public Warrants, or if a holder holds Units registered in its own name, the holder must contact Continental, Summit’s transfer agent, directly and instruct it to do so. The redemption rights include the requirement that a holder must identify itself in writing as a beneficial holder and provide its legal name, phone number and address to Continental in order to validly redeem its Summit Public Shares.

If the Business Combination is not consummated, the Summit Public Shares will not be redeemed and instead will be returned to the respective holder, broker or bank. In such case, Summit Shareholders may only share in the assets of the Trust Account upon the liquidation of Summit. This may result in Summit Shareholders receiving less than they would have received if the Business Combination was completed and they had exercised redemption rights in connection therewith due to potential claims of creditors.

If a Summit Public Shareholder satisfies the requirements for exercising redemption rights with respect to all or a portion of the Summit Public Shares he, she or it holds and the Business Combination is consummated, Summit will redeem such Summit Public Shares for a per-share price, payable in cash, equal to the pro rata portion of the amount on deposit in the Trust Account calculated as of two business days prior to the consummation of the Business Combination, including interest earned on the funds

held in the Trust Account and not previously released to Summit (less taxes payable and up to \$100,000 of interest to pay dissolution expenses). For illustrative purposes, as of February 2, 2023, the Record Date, this would have amounted to approximately \$10.1 per issued and outstanding Summit Public Share. There are currently no owed but unpaid income taxes on the funds in the Trust Account. However, the proceeds deposited in the Trust Account could become subject to the claims of Summit's creditors, if any, which would have priority over the claims of Summit Shareholders. Therefore, the per share distribution from the Trust Account in such a situation may be less than originally expected due to such claims. It is expected that the funds to be distributed to Summit Public Shareholders electing to redeem their Summit Public Shares shall be distributed promptly after the consummation of the Business Combination.

Any request for redemption, once made by a Summit Public Shareholder, may be withdrawn at any time until the deadline for exercising redemption requests. After this time, a request for redemption may not be withdrawn unless the Summit Board determines (in its sole discretion) to permit the withdrawal of such redemption request (which it may do in whole or in part). Such a request must be made by contacting Continental, Summit's transfer agent, at the phone number or address listed under the question "Who can help answer my questions?" below.

No request for redemption shall be honored unless the holder's share certificates (if any) or shares have been delivered (either physically or electronically) to Continental, Summit's transfer agent, in the manner described above, at least two business days prior to the vote at the Extraordinary General Meeting.

If you exercise your redemption rights, then you shall be exchanging your Summit Public Shares for cash and shall not be entitled to receive any YS Biopharma Ordinary Shares in respect of such redeemed shares upon consummation of the Business Combination.

If you are a holder of Summit Public Shares and you exercise your redemption rights, such exercise shall not result in the loss of any Summit Warrants that you may hold. Assuming 100% redemption, the Summit Warrants owned by such redeeming Summit Public Shareholders will be worth approximately \$2.8 million in the aggregate based on the closing price of Summit Warrants on the Record Date of \$0.2774.

The closing price of Summit Public Shares on the Record Date was \$10.12. The cash held in the Trust Account on such date was approximately \$202 million (approximately \$10.1 per Summit Public Share). Prior to exercising redemption rights, Summit Public Shareholders should verify the market price of Summit Public Shares as they may receive higher proceeds from the sale of their Summit Public Shares in the public market than from exercising their redemption rights if the market price per share is higher than the redemption price. Summit cannot assure its shareholders that they shall be able to sell their Summit Public Shares in the open market, even if the market price per share is higher than the redemption price stated above, as there may not be sufficient liquidity in its securities when its shareholders wish to sell their shares.

For the procedures to be followed if you wish to redeem your shares for cash, see the section entitled "Extraordinary General Meeting of Summit Shareholders — Redemption Rights."

**Q: If I am a holder of Summit Warrants, can I exercise redemption rights with respect to my warrants?**

A: No. The holders of Summit Warrants have no redemption rights with respect to such securities.

**Q: How do the Summit Public Warrants differ from the Summit Private Warrants, and what are the related risks for any holder of Summit Public Warrants post-Business Combination?**

A: The Summit Private Warrants (including the Summit Class A Ordinary Shares issuable upon exercise of the Summit Private Warrants) are not transferable, assignable or salable until 30 days after the completion of the Business Combination (except, among other limited exceptions, to Summit's officers and directors and other persons or entities affiliated with the Sponsor), and they will not be redeemable (except as described in the section entitled "Description of YS Biopharma Securities — Warrants") so long as they are held by the Sponsor or its permitted transferees. The Sponsor, or its permitted transferees, have the option to exercise the Summit Private Warrants for cash or on a "cashless" basis. Otherwise, the Summit Private Warrants have terms and provisions that are identical to those of the Summit Public Warrants,

including as to exercise price, exercisability and exercise period. If the Summit Private Warrants are held by holders other than the Sponsor or its permitted transferees, the Summit Private Warrants will be redeemable by Summit (or YS Biopharma after the consummation of the Business Combination) in all redemption scenarios and exercisable by the holders on the same basis as the Summit Public Warrants.

Upon the consummation of the Business Combination, each Summit Warrant outstanding immediately prior will cease to be a warrant with respect to Summit Public Shares and be assumed by YS Biopharma and converted into a YS Biopharma Warrant entitling the holder thereof to purchase such number of YS Biopharma Ordinary Share on a one-on-one basis. Each YS Biopharma Warrant will otherwise continue to have and be subject to substantially the same terms and conditions as were applicable to such Summit Warrant immediately prior to the consummation of the Business Combination (including any repurchase rights and cashless exercise provisions).

Following the Business Combination, YS Biopharma may redeem public YS Biopharma Warrants prior to their exercise at a time that is disadvantageous to the holders of such YS Biopharma Warrants, thereby making such warrants worthless. More specifically:

- YS Biopharma will have the ability to redeem outstanding YS Biopharma Warrants at any time after they become exercisable and prior to their expiration, at a price of \$0.01 per warrant, provided that the last reported sales price of YS Biopharma Ordinary Shares equals or exceeds \$18.00 per share (as adjusted for capitalization, share dividends, split-up and the like) for any 20 trading days within a 30 trading-day period ending on the third trading day prior to proper notice of such redemption and provided that certain other conditions are met.
- YS Biopharma will also have the ability to redeem outstanding YS Biopharma Warrants at any time after they become exercisable and prior to their expiration, at a price of \$0.10 per warrant upon a minimum of 30 days' prior written notice of redemption provided that the last reported sales price of YS Biopharma Ordinary Shares equals or exceeds \$10.00 per share (as adjusted for capitalization, share dividends, split-up and the like) for any 20 trading days within a 30 trading-day period ending on the third trading day prior to proper notice of such redemption and provided that certain other conditions are met, including that holders of the YS Biopharma Warrants will be able to exercise their YS Biopharma Warrants prior to redemption for a number of YS Biopharma Ordinary Shares determined based on the redemption date and the fair market value of the YS Biopharma Ordinary Shares. Please see the section entitled "Description of YS Biopharma Securities — Warrants." The value received upon exercise of the YS Biopharma Warrants (1) may be less than the value the holders would have received if they had exercised their YS Biopharma Warrants at a later time where the underlying share price is higher and (2) may not compensate the holders for the value of the YS Biopharma Warrants, including because the number of YS Biopharma Ordinary Shares received is capped at 0.361 YS Biopharma Ordinary Shares per warrant (subject to adjustment) irrespective of the remaining life of the YS Biopharma Warrants.

In each case, YS Biopharma may only call the YS Biopharma Warrants for redemption upon a minimum of 30 days' prior notice of redemption.

Redemption of the outstanding YS Biopharma Warrants could force holders of the YS Biopharma Warrants to (a) exercise YS Biopharma Warrants and pay the exercise price therefor at a time when it may be disadvantageous for such holders to do so, (b) sell YS Biopharma Warrants at the then-current market price when they might otherwise wish to hold their YS Biopharma Warrants or (c) accept the nominal redemption price which, at the time the outstanding YS Biopharma Warrants are called for redemption, is likely to be substantially less than the market value of the YS Biopharma Warrants.

**Q: If I am a holder of Units, can I exercise redemption rights with respect to my Units?**

A: Not without first separating the Units. Holders of outstanding Units must separate the Units into the underlying Summit Public Shares and Summit Public Warrants prior to exercising redemption rights with respect to Summit Public Shares.

If a broker, bank, or other nominee holds your Units, you must instruct such broker, bank or nominee to separate your Units. Your nominee must send written instructions by facsimile to Continental, Summit's

transfer agent. Such written instructions must include the number of Units to be split and the nominee holding such Units. Your nominee must also initiate electronically, using The Depository Trust Company's DWAC (Deposit/Withdrawal at Custodian) System, a withdrawal of the relevant Units and a deposit of the number of Summit Public Shares and Summit Public Warrants represented by such Units. This must be completed far enough in advance to permit your nominee to exercise your redemption rights upon the separation of the Summit Public Shares from the Units. While this is typically done electronically the same business day, you should allow at least one full business day to accomplish the separation. If you fail to cause your shares to be separated in a timely manner, you shall likely not be able to exercise your redemption rights.

If you hold Units registered in your own name, you must deliver the certificate for such Units to Continental, Summit's transfer agent, with written instructions to separate such Units into Summit Public Shares and Summit Public Warrants. This must be completed far enough in advance to permit the mailing of the share certificates back to you so that you may then exercise your redemption rights upon the separation of the Summit Public Shares from the Units. See "How do I exercise my redemption rights?" above. The address of Continental is listed under the question "Who can help answer my questions?" below.

**Q: What happens if a substantial number of Summit Shareholders vote in favor of the Business Combination Proposal and the Merger Proposal and exercise their redemption rights?**

A: Summit Public Shareholders may vote in favor of the Business Combination Proposal and the Merger Proposal and exercise their redemption rights, although they are not required to vote in any way to exercise such redemption rights. Accordingly, the Business Combination may be consummated even though the funds available from the Trust Account and the number of Summit Shareholders are substantially reduced as a result of redemption by Summit Public Shareholders.

The Summit Articles provide that in no event will Summit redeem Summit Public Shares in an amount that would cause its net tangible assets to be less than \$5,000,001, such that Summit is not subject to the SEC's "penny stock" rules. In the event of significant redemptions, with fewer shares and Summit Shareholders, the trading market for YS Biopharma Ordinary Shares may be less liquid than the market for Summit Public Shares was prior to the Business Combination. In addition, in the event of significant redemptions, YS Biopharma may not be able to meet the Nasdaq listing standards. It is a condition to consummation of the Business Combination in the Business Combination Agreement that the YS Biopharma Ordinary Shares to be issued in connection with the Business Combination shall have been approved for listing on Nasdaq, subject only to official notice of issuance thereof. YS Biopharma and Summit have certain obligations in the Business Combination Agreement to use reasonable best efforts in connection with the Business Combination, including with respect to satisfying this Nasdaq listing condition.

In addition, consummation of the transactions contemplated by the Business Combination Agreement is subject to the condition that (i) the amount of cash proceeds from the Trust Account, plus (ii) the aggregate amount of cash that has been funded to, or that will be funded immediately prior to or concurrently with the Closing to Summit pursuant to the Forward Purchase Agreements, plus (iii) any amount raised pursuant to permitted equity financings prior to the Closing (excluding any proceeds that will be invested by existing shareholders or creditors of YS Biopharma immediately prior to the First Merger Effective Time), minus (iv) the aggregate amount payable to Summit Public Shareholders exercising their redemption rights, in the aggregate equaling no less than \$30 million.

**Q: Do I have appraisal or dissent rights if I object to the proposed Business Combination?**

A: Holders of record of Summit Shares may have appraisal rights in connection with the Business Combination under the Cayman Islands Companies Act. In this proxy statement/prospectus, these appraisal or dissent rights are sometimes referred to as "Dissent Rights." Holders of record of Summit Shares wishing to exercise such Dissent Rights and make a demand for payment of the fair value for his, her or its Summit Shares must give written objection to the First Merger to Summit prior to the shareholder vote at the Extraordinary General Meeting to approve the First Merger and follow the procedures set out in Section 238 of the Cayman Islands Companies Act, noting that any such dissenter

rights may subsequently be lost and extinguished pursuant to Section 239 of the Cayman Islands Companies Act which states that no such dissenter rights shall be available in respect of shares of any class for which an open market exists on a recognized stock exchange or recognized interdealer quotation system at the expiry date of the period allowed for written notice of an election to dissent provided that the merger consideration constitutes inter alia shares of any company which at the effective date of the merger are listed on a national securities exchange. The Business Combination Agreement provides that, if any Summit shareholder exercises Dissent Rights then, unless Summit and YS Biopharma elect by agreement in writing otherwise, the First Merger shall not be consummated before the expiry date of the period allowed for written notice of an election to dissent in order to invoke the exemption under Section 239 of the Cayman Islands Companies Act. Summit believes that such fair value would equal the amount that Summit Shareholders would obtain if they exercised their redemption rights as described herein. A Summit Shareholder which elects to exercise Dissent Rights must do so in respect of all of the Summit Shares that person holds and will lose their right to exercise their redemption rights as described herein. See the section entitled “Extraordinary General Meeting of Summit Shareholders — Appraisal Rights under the Cayman Islands Companies Act.”

Summit Shareholders are recommended to seek their own advice as soon as possible on the application and procedure to be followed in respect of the appraisal rights under the Cayman Islands Companies Act.

**Q: Can I exercise redemption rights and appraisal or dissenters’ rights under the Cayman Islands Companies Act?**

A: No. Any Summit Public Shareholder who elects to exercise Dissent Rights (which dissent rights are discussed in the section titled “Do I have appraisal or dissent rights if I object to the proposed Business Combination?”) will lose their right to have their Summit Public Shares redeemed in accordance with the Summit Articles. The certainty provided by the redemption process may be preferable for Summit Public Shareholders wishing to exchange their Summit Public Shares for cash. This is because Dissent Rights may be lost or extinguished, including where Summit and the other parties to the Business Combination Agreement determine to delay the consummation of the Business Combination in order to invoke the limitation on dissenter rights under Section 239 of the Cayman Islands Companies Act, in which case any Summit Public Shareholder who has sought to exercise Dissent Rights would only be entitled to receive the merger consideration comprising the number of newly issued YS Biopharma Ordinary Shares equal to the Class A Exchange Ratio for each of their Summit Public Shares.

**Q: I am a Summit warrant holder. Why am I receiving this proxy statement/prospectus?**

A: As a holder of Summit Warrants, which shall, as a result of the Business Combination, become YS Biopharma Warrants, you shall be entitled to purchase such number of YS Biopharma Ordinary Share equal to the Class A Exchange Ratio in lieu of one Summit Public Share at a purchase price of \$11.50 upon consummation of the Business Combination. This proxy statement/prospectus includes important information about YS Biopharma and the business of YS Biopharma and its subsidiaries following consummation of the Business Combination. Since holders of Summit Warrants shall become holders of YS Biopharma Warrants and may become holders of YS Biopharma Ordinary Shares upon consummation of the Business Combination, we urge you to read the information contained in this proxy statement/prospectus carefully.

**Q: What happens to the funds deposited in the Trust Account after consummation of the Business Combination?**

A: As of September 30, 2022, Summit had investments held in the Trust Account of \$201,200,243. After consummation of the Business Combination, the funds in the Trust Account shall be released to Merger Sub (as the surviving entity in the Merger) and used by Merger Sub to pay Summit Public Shareholders who exercise redemption rights and to pay fees and expenses incurred in connection with the Business Combination with YS Biopharma. Any remaining cash will be used for working capital and general corporate purposes.

**Q: What happens if the Business Combination is not consummated?**

A: If Summit does not complete the Business Combination with YS Biopharma (or another initial business

combination) by the Final Redemption Date, Summit must redeem 100% of the outstanding Summit Public Shares, at a per-share price, payable in cash, equal to the amount then held in the Trust Account (net of taxes payable and less up to \$100,000 of interest to pay dissolution expenses) divided by the number of outstanding Summit Public Shares.

**Q: When do you expect the Business Combination to be completed?**

A: It is currently expected that the Business Combination will be consummated in the first quarter of 2023, promptly following the satisfaction, or waiver, of the conditions precedent to Closing set forth in the Business Combination Agreement, including the approval of the Business Combination Proposal and the Merger Proposal by the holders of Summit Shares. For a description of the conditions for the completion of the Business Combination, see the section entitled “The Business Combination Agreement — Conditions Precedent to Consummate the Business Combination.”

**Q: What else do I need to do now?**

A: Summit urges you to read carefully and consider the information contained in this proxy statement/prospectus, including the Annexes, and to consider how the Business Combination shall affect you as a shareholder and/or warrant holder of Summit. Shareholders should then vote as soon as possible in accordance with the instructions provided in this proxy statement/prospectus and on the enclosed proxy card.

**Q: When and where will the Extraordinary General Meeting take place?**

A: The Extraordinary General Meeting will be held on March 1, 2023, at 9:00 a.m., Eastern Time, at 35th Floor, Two Exchange Square, 8 Connaught Place Central, Hong Kong and virtually over the Internet by means of a live audio webcast. You may attend the Extraordinary General Meeting webcast by accessing the web portal located at <https://www.cstproxy.com/summithealthcarespac/2023> and following the instructions set forth below. In order to maintain the interactive nature of the Extraordinary General Meeting, virtual attendees who have registered for the meeting and entered a valid control number will be able to:

- vote via the web portal during the Extraordinary General Meeting webcast; and
- submit questions to the chairman during the Extraordinary General Meeting.

Shareholders who have registered for the meeting and entered a valid control number may submit questions to the chairman during the meeting through the Extraordinary General Meeting webcast by typing in the “Submit a question” box.

A separate conference line to allow participants to communicate with each other during the Extraordinary General Meeting will also be made available.

**Q: How do I attend the Extraordinary General Meeting?**

A: Due to health concerns stemming from the COVID-19 pandemic and to support the health and well-being of Summit Shareholders, you are encouraged to attend the Extraordinary General Meeting virtually. To register for and attend the Extraordinary General Meeting virtually, please follow these instructions as applicable to the nature of your ownership of Summit Shares:

- *Shares Held of Record.* If you are a record holder, and you wish to attend the Extraordinary General Meeting virtually, go to <https://www.cstproxy.com/summithealthcarespac/2023>, enter the control number you received on your proxy card or notice of the meeting and click on the “Click here to register for the online meeting” link at the top of the page. Immediately prior to the start of the Extraordinary General Meeting, you will need to log back into the meeting site using your control number.
- *Shares Held in Street Name.* If you hold your Summit Shares in “street name”, which means your shares are held of record by a broker, bank or nominee, and you wish to attend the Extraordinary General Meeting virtually, you must obtain a legal proxy from the shareholder of record and e-mail a copy (a legible photograph is sufficient) of your proxy to [proxy@continentalstock.com](mailto:proxy@continentalstock.com) no later than



48 hours prior to the Extraordinary General Meeting. Holders should contact their broker, bank or nominee for instructions regarding obtaining a proxy. Holders who e-mail a valid legal proxy will be issued a meeting control number that will allow them to register to attend and participate in the Extraordinary General Meeting. You will receive an e-mail prior to the meeting with a link and instructions for entering the Extraordinary General Meeting. “Street name” holders should contact Continental no later than 9:00 a.m., Eastern Time, on February 26, 2023.

Shareholders will also have the option to listen to the Extraordinary General Meeting by telephone by calling:

- Within the United States and Canada: +1 800-450-7155 (toll-free)
- Outside of the United States and Canada: +1 857-999-9155 (standard rates apply)

Conference ID: 0968107# and follow the instructions (have your proxy card available when you call). You will not be able to vote or submit questions unless you register for and log in to the Extraordinary General Meeting webcast as described above.

**Q: How do I vote?**

A: If you are a holder of record of Summit Shares at close of business on the Record Date, you may vote electronically at the Extraordinary General Meeting by navigating to <https://www.cstproxy.com/summithealthcarespac/2023> and entering the control number on your proxy card or by submitting a proxy for the Extraordinary General Meeting. You may submit your proxy by completing, signing, dating and returning the enclosed proxy card in the accompanying pre-addressed postage paid envelope so as to be received by Summit no later than at 9:00 a.m. Eastern Time, on February 27, 2023, being 48 hours before the time appointed for the holding of the Extraordinary General Meeting (or, in the case of an adjournment, no later than 48 hours before the time appointed for the holding of the adjourned meeting). If you hold your Summit Shares in “street name,” which means your shares are held of record by a broker, bank or nominee, you should contact your broker, bank or nominee to ensure that votes related to the shares you beneficially own are properly counted. In this regard, you must provide the broker, bank or nominee with instructions on how to vote your shares or, if you wish to attend the Extraordinary General Meeting and vote remotely, obtain a legal proxy from your broker, bank or nominee and a control number from Continental, available once you have received your proxy by emailing [proxy@continentalstock.com](mailto:proxy@continentalstock.com).

**Q: If my shares are held in “street name,” will my broker, bank or nominee automatically vote my shares for me?**

A: No. As disclosed in this proxy statement/prospectus, your broker, bank or nominee cannot vote your shares on the Business Combination Proposal, the Merger Proposal or the Adjournment Proposal unless you provide instructions on how to vote in accordance with the information and procedures provided to you by your broker, bank or nominee. If you are a Summit Shareholder holding your shares in “street name” and you do not instruct your broker, bank or other nominee on how to vote your shares, your broker, bank or other nominee will not vote your shares on the Business Combination Proposal, the Merger Proposal or the Adjournment Proposal. Such abstentions and broker non-votes will have no effect on the vote count for any of the Proposals.

**Q: May I change my vote after I have mailed my signed proxy card?**

A: Yes. If you are a holder of record of Summit Shares and you give a proxy, you may revoke it at any time before it is exercised by doing any one of the following:

- you may send another signed proxy card to Continental, Summit’s transfer agent, at the address set forth under the question “Who can help answer my questions?” below so that it is received no later than 48 hours before the time appointed for the holding of the Extraordinary General Meeting (or, in the case of an adjournment, no later than 48 hours before the time appointed for the holding of the adjourned meeting);
- you may notify the Summit Board in writing, prior to the vote at the Extraordinary General Meeting, that you have revoked your proxy; or

- you may attend the Extraordinary General Meeting virtually over the Internet by joining the live audio webcast and vote electronically through the web portal during the Extraordinary General Meeting, although your attendance alone will not revoke any proxy that you have previously given.

If you hold your Summit Shares in “street name,” you may submit new instructions on how to vote your shares by contacting your broker, bank or nominee.

**Q: What happens if I fail to take any action with respect to the Extraordinary General Meeting?**

A: If you fail to take any action with respect to the Extraordinary General Meeting and the Business Combination is approved by shareholders and consummated, you shall become a shareholder and/or warrant holder of YS Biopharma. If you fail to take any action with respect to the Extraordinary General Meeting and the Business Combination is not approved, you shall continue to be a shareholder and/or warrant holder of Summit.

**Q: What should I do if I receive more than one set of voting materials?**

A: Shareholders may receive more than one set of voting materials, including multiple copies of this proxy statement/prospectus and multiple proxy cards or voting instruction cards. For example, if you hold your Summit Shares in more than one brokerage account, you shall receive a separate voting instruction card for each brokerage account in which you hold shares. If you are a holder of record and your shares are registered in more than one name, you shall receive more than one proxy card. Please complete, sign, date and return each proxy card and voting instruction card that you receive in order to cast a vote with respect to all of your Summit Shares.

**Q: What happens if I sell my Summit Shares before the Extraordinary General Meeting?**

A: The Record Date for the Extraordinary General Meeting is earlier than the date of the Extraordinary General Meeting and earlier than the date the Business Combination is expected to be completed. If you transfer your Summit Shares after the applicable Record Date, but before the Extraordinary General Meeting date, unless you grant a proxy to the transferee, you shall retain your right to vote at the Extraordinary General Meeting.

**Q: Who will solicit and pay the cost of soliciting proxies for the Extraordinary General Meeting?**

A: Summit will pay the cost of soliciting proxies for the Extraordinary General Meeting. Summit has engaged Advantage Proxy, Inc. (“Advantage”) to assist in the solicitation of proxies for the Extraordinary General Meeting. Summit has agreed to pay Advantage a fixed fee of \$10,000, to reimburse Advantage for certain out-of-pocket expenses incurred on Summit’s behalf, and to indemnify Advantage against certain losses, claims and liabilities arising from such engagement. Summit will also reimburse banks, brokers and other custodians, nominees and fiduciaries representing beneficial owners of Summit Public Shares for their expenses in forwarding soliciting materials to beneficial owners of Summit Public Shares and in obtaining voting instructions from those owners. Summit’s directors and officers may also solicit proxies by telephone, by facsimile, by mail, on the Internet or in person. They will not be paid any additional amounts for soliciting proxies.

**Q: Where can I find the voting results of the Extraordinary General Meeting?**

A: The preliminary voting results will be announced at the Extraordinary General Meeting. Summit will publish final voting results of the Extraordinary General Meeting in a Current Report on Form 8-K within four business days after the Extraordinary General Meeting.

**Q: Who can help answer my questions?**

A: If you have questions about the proposals or if you need additional copies of this proxy statement/prospectus or the enclosed proxy card you should contact Summit’s proxy solicitor as follows:

Advantage Proxy, Inc.  
P.O. Box 13581  
Des Moines, WA 98198

Attn: Karen Smith  
Toll Free Telephone: (877) 870-8565  
Collect Telephone: (206) 870-8565  
E-mail: [ksmith@advantageproxy.com](mailto:ksmith@advantageproxy.com)

To obtain timely delivery, shareholders must request the materials no later than February 22, 2023, or five business days prior to the Extraordinary General Meeting.

You may also obtain additional information about Summit from documents filed with the SEC by following the instructions in the section entitled “Where You Can Find More Information.”

If you are a Summit Public Shareholder and you intend to seek redemption of your Summit Public Shares, you shall need to either tender your share certificates (if any) to Continental, Summit’s transfer agent, at the address below or deliver your Summit Public Shares to the transfer agent electronically using The Depository Trust Company’s DWAC System, in each case at least two business days prior to the vote at the Extraordinary General Meeting. If you have questions regarding the certification of your position or delivery of your shares for redemption, please contact Summit’s transfer agent as follows:

Continental Stock Transfer & Trust Company  
1 State Street 30th Floor  
New York, NY 10004-1561  
Attn: Mark Zimkind  
Email: [mzimkind@continentalstock.com](mailto:mzimkind@continentalstock.com)

## SUMMARY OF THE PROXY STATEMENT/PROSPECTUS

*This summary highlights selected information from this proxy statement/prospectus and does not contain all of the information that is important to you. To better understand the proposals to be submitted for a vote at the Extraordinary General Meeting, including the Business Combination, you should read this entire document carefully, including the Business Combination Agreement attached as Annex A to this proxy statement/prospectus, to fully understand the Business Combination Agreement, the Business Combination and the other matters being considered at the Extraordinary General Meeting of Summit. For additional information, see “Where You Can Find More Information” beginning on page 387. Each item in this summary refers to the page of this proxy statement/prospectus on which that subject is discussed in more detail.*

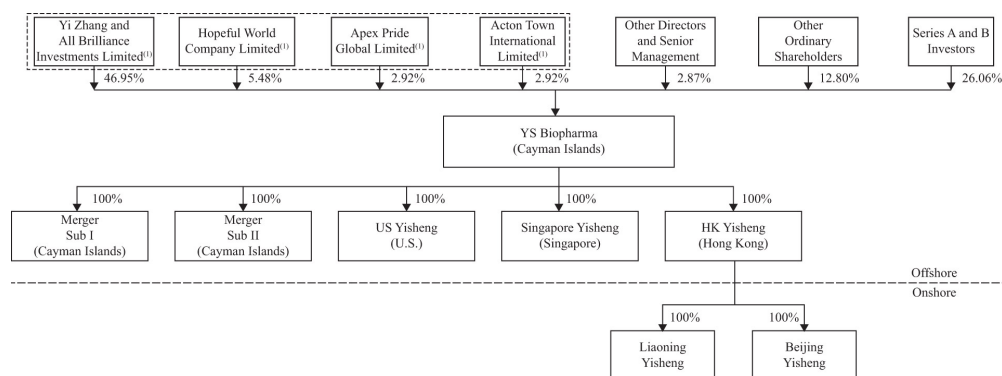
### The Parties to the Business Combination (page 220)

#### YS Group

YS Group is a global biopharmaceutical company dedicated to discovering, developing, manufacturing and commercializing new generations of vaccines and therapeutic biologics for infectious diseases and cancer. YS Group commercializes vaccines with significant revenue and growth potential. YS Group takes pride in its marketed vaccine product, YSJA rabies vaccine, which was the first aluminum-free lyophilized rabies vaccine launched in China. Since YS Group launched its production at its current GMP-compliant facilities in February 2020 and as of September 30, 2022, YS Group had sold more than 16 million doses of YSJA rabies vaccines to approximately 1,625 county-level CDCs in China. YS Group has also developed its proprietary PIKA immunomodulating technology platform, empowering a robust pipelines of innovative vaccines and therapeutic biologics. As of September 30, 2022, YS Group had four product candidates at various clinical trial stages, including PIKA rabies vaccine, PIKA recombinant COVID-19 vaccine, PIKA YS-ON-001 and PIKA YS-HBV-001, and four preclinical stage product candidates, targeting HBV, influenza, rabies and cancer with significant unmet medical needs. In addition, YS Group is working on a series of therapeutic targets and products at the discovery stage.

YS Biopharma was incorporated under the laws of Cayman Islands as an exempted company with limited liability in November 2020. The history of YS Group can be traced back to 2002 when Mr. Yi Zhang, its founder and controlling shareholder started the vaccine business in the PRC, and has expanded its international business operation in the United States and Singapore since 2009.

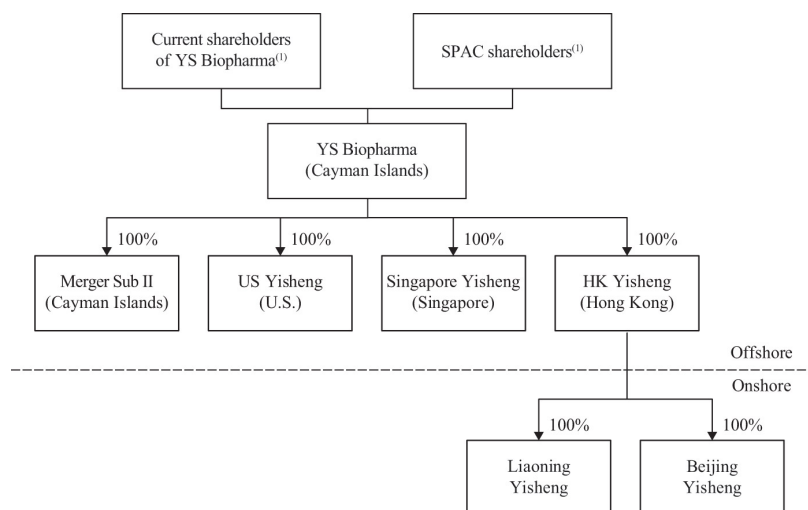
The following diagram illustrates the corporate structure of YS Group as of the date of this proxy statement/prospectus.



(1) (i) Yi Zhang and the entities controlled by Yi Zhang, including An Diang Group Holdings Limited, YXRT Company Limited and All Brilliance Investments Limited; (ii) Rui Mi and the entities controlled by Rui Mi, including Honeydrew Flower Field Ltd., ZM Home Limited and Hopeful World Company Limited; (iii) Xu Zhang and the entities controlled by Xu Zhang, including Apex Pride Global Limited, Prosperous Sunrise Company Limited and Much Galaxy Company Limited; and (iv) Nan Zhang and the entities controlled by Nan Zhang, including Spring Nanmu Islands Ltd., NNZF Company Limited and Acton Town International Limited (the “Concert Parties”) entered into a concert party agreement (the “Concert Party Agreement”), pursuant to which, the concert parties agree and acknowledge that they have voted since commencement of YS Group’s business, and will continue to vote, themselves or through any entity directly or indirectly controlled by them that own YS Biopharma’s equity interest, unanimously for any resolutions proposed at the

board meetings and/or shareholders meeting of YS Biopharma, where applicable. According to the Concert Party Agreement, if the Concert Parties are unable to reach unanimous consensus, Yi Zhang is entitled to determine how to vote for and on behalf of himself and the Concert Parties. The Concert Agreement will continue after the Business Combination and shall remain effective unless otherwise terminated by mutual consent of the Concert Parties.

The following graph illustrates the corporate structure of YS Group after completion of the Business Combination.



(1) See the section entitled “Questions and Answers about the Proposals—Q: What shall be the relative equity stakes of Summit Shareholders, YS Biopharma shareholders immediately after the consummation of the Business Combination?” for details of the pro forma equity interests of shareholders after the completion of the Business Combination.

The mailing address of YS Biopharma’s principal executive office is Building No. 2, 38 Yongda Road Daxing Biomedical Industry Park, Daxing District, Beijing, PRC, and its phone number is +86-10-89202086. YS Biopharma’s corporate website address is <https://www.yishengbio.com>. YS Biopharma’s website and the information contained on, or that can be accessed through, the website is not deemed to be incorporated by reference in, and is not considered part of, this proxy statement/prospectus. After the consummation of the Business Combination, YS Biopharma will become the public company.

### **Summit**

Summit is a blank check company incorporated on December 22, 2020 as a Cayman Islands exempted company for the purpose of effecting a merger, share exchange, asset acquisition, share purchase, reorganization or similar business combination with one or more businesses or entities. Summit’s objective was to identify and acquire targets in the healthcare industry in Asia, with a focus on pharmaceuticals, medtech and diagnostics, though Summit reserved the right to pursue an acquisition opportunity in any business or industry.

Summit consummated the IPO on June 11, 2021. Summit’s Units, Summit Public Shares and Summit Public Warrants are each traded on Nasdaq under the symbols “SMIHU,” “SMIH” and “SMIHW” respectively.

Summit’s registered office is located at PO Box 309, Ugland House, Grand Cayman, KY1-1104, Cayman Islands, and its telephone number is +852 2115 7212.

### **Merger Sub I**

Oceanview Bioscience Acquisition Co., Ltd. (“Merger Sub I”), an exempted company limited by shares incorporated under the laws of the Cayman Islands, is a direct wholly owned subsidiary of YS Biopharma. Merger Sub I was formed solely for the purpose of effecting the Business Combination and has not carried on any activities other than those in connection with the Business Combination. The address and telephone number for Merger Sub I’s principal executive offices are the same as those for YS Biopharma.

***Merger Sub II***

Hudson Biomedical Group Co., Ltd. (“Merger Sub II”), an exempted company limited by shares incorporated under the laws of the Cayman Islands, is a direct wholly owned subsidiary of YS Biopharma. Merger Sub II was formed solely for the purpose of effecting the Business Combination and has not carried on any activities other than those in connection with the Business Combination. The address and telephone number for Merger Sub II’s principal executive offices are the same as those for YS Biopharma.

**The Business Combination Proposal (page 159)**

On September 29, 2022, Summit, YS Biopharma, Merger Sub I, and Merger Sub II entered into the Business Combination Agreement, which provides for (i) the merger of Merger Sub I with and into Summit (the “First Merger”), with Summit surviving the First Merger as the surviving entity (the “Surviving Entity”) and becoming a wholly-owned subsidiary of YS Biopharma, and (ii) the merger of the Surviving Entity with and into Merger Sub II (the “Second Merger,” and together with the First Merger, the “Mergers,” together with other transactions contemplated by the Business Combination Agreement, the “Business Combination”), with Merger Sub II surviving the Second Merger as the surviving company (the “Surviving Company”) and remaining as the wholly-owned subsidiary of YS Biopharma. As a result of and upon consummation of the Business Combination, the shareholders of Summit will become shareholders of YS Biopharma, and YS Biopharma will become a public company with its ordinary shares and warrants listed on the Nasdaq. Capitalized terms in this summary of the Business Combination Proposal not otherwise defined in this proxy statement/prospectus shall have the meanings ascribed to them in the Business Combination Agreement.

Prior to the First Merger Effective Time, YS Biopharma will be renamed as YS Biopharma Co., Ltd..

***YS Biopharma Capital Restructuring***

Subject to, and in accordance with the terms and subject to the conditions set forth in the Business Combination Agreement, immediately prior to the First Merger Effective Time, (i) each YS Biopharma Preferred Shares will be converted into one YS Biopharma Ordinary Shares; (ii) each four of the shares and options of YS Biopharma will be consolidated into one share and one option of YS Biopharma, respectively, subject to rounding up to the nearest whole number of shares; and (iii) the third amended and restated memorandum and articles of association of YS Biopharma shall be adopted and become effective. Items (i) through (iii) are herein referred to as the “YS Biopharma Capital Restructuring.”

***The Mergers******The First Merger***

At the First Merger Effective Time, (i) Merger Sub I shall merge with and into Summit, following which the separate corporate existence of Merger Sub I shall cease and Summit shall continue as the Surviving Entity after the First Merger and become a direct, wholly-owned subsidiary of YS Biopharma; (ii) all the property, rights, privileges, agreements, powers and franchises, debts, liabilities, duties and obligations of Merger Sub I and Summit shall become the property, rights, privileges, agreements, powers and franchises, debts, liabilities, duties and obligations of the Surviving Entity, which shall include the assumption by the Surviving Entity of any and all agreements, covenants, duties and obligations of Merger Sub I and Summit set forth in the Business Combination Agreement to be performed after the First Merger Effective Time; (iii) the memorandum and articles of association of Merger Sub I, as in effect immediately prior to the First Merger Effective Time, shall be the memorandum and articles of association of the Surviving Entity; (iv) the directors and officers of Summit immediately prior to the First Merger Effective Time shall resign and the sole director and officers of Merger Sub I immediately prior to the First Merger Effective Time shall be the sole director and officers of the Surviving Entity, each to hold office in accordance with the memorandum and articles of association of the Surviving Entity; and (v) (a) Mr. Bo Tan (or in the event such person is unable or unwilling to serve as a director, another individual who was a director of Summit prior to the Closing designated by Summit in writing at least two Business Days before the First Merger Effective Time, subject to such person passing customary background checks by YS Biopharma) and (b) one additional director as nominated by YS Biopharma shall be appointed as directors on the board of directors of YS Biopharma, in addition to the then existing directors of YS Biopharma, effective as of the First Merger Effective Time, and each of such newly

appointed directors shall hold office in accordance with the Amended YS Biopharma Articles until he is removed or resign in accordance with the Amended YS Biopharma Articles or until his successor is duly elected or appointed and qualified. Ms. Rui Lin and Mr. Zhi Chen shall resign as directors of YS Biopharma, effective immediately prior to the First Merger Effective Time.

#### *The Second Merger*

At the Second Merger Effective Time, (i) the Surviving Entity shall merge with and into Merger Sub II, following which the separate corporate existence of the Surviving Entity shall cease and Merger Sub II shall continue as the Surviving Company after the Second Merger and as a direct, wholly-owned subsidiary of YS Biopharma; (ii) all the property, rights, privileges, agreements, powers and franchises, debts, liabilities, duties and obligations of the Surviving Entity and Merger Sub II shall become the property, rights, privileges, agreements, powers and franchises, debts, liabilities, duties and obligations of the Surviving Company, which shall include the assumption by the Surviving Company of any and all agreements, covenants, duties and obligations of the Surviving Entity and Merger Sub II set forth in the Business Combination Agreement to be performed after the Second Merger Effective Time; (iii) the memorandum and articles of association of Merger Sub II, as in effect immediately prior to the Second Merger Effective Time, shall be the memorandum and articles of association of the Surviving Company, until thereafter changed or amended as provided therein or by applicable law; and (iv) the sole director and officers of Merger Sub II immediately prior to the Second Merger Effective Time shall be the sole director and officers of the Surviving Company, each to hold office in accordance with the memorandum and articles of association of the Surviving Company.

For more information about the Merger Proposal, see the sections titled “The Business Combination Agreement — The First Merger”, “The Business Combination Agreement — The Second Merger” and “The Merger Proposal.”

#### ***Conditions Precedent to Consummate the Business Combination***

In addition to the approval of the Business Combination Proposal and the Merger Proposal, unless waived by the parties to the Business Combination Agreement, the closing of the Business Combination is subject to a number of conditions set forth in the Business Combination Agreement. For more information about the closing conditions to the Business Combination, see the section titled “The Business Combination Agreement — Conditions Precedent to Consummate the Business Combination.”

#### ***Related Agreements***

##### *Shareholder Support Agreement*

Concurrently with the execution of the Business Combination Agreement, YS Biopharma and Summit entered into a Shareholder Support Agreement and Deed (the “Shareholder Support Agreement”) with certain YS Biopharma shareholders (the “YSB Shareholders”) and certain Summit Shareholders (the “SPAC Shareholders”) and together with the YSB Shareholders, the “Supporting Shareholders”) with respect to the shares of YS Biopharma and Summit currently owned by the Supporting Shareholders. The Shareholder Support Agreement provides that, among other things, (i) the Supporting Shareholders will appear at shareholders meetings of YS Biopharma (or Summit, as applicable) and vote in favor of, consent to or approve the Business Combination Agreement and the transactions contemplated by the Business Combination Agreement, whether at a shareholder meeting of YS Biopharma (or Summit, as applicable) or by written consent, (ii) the Supporting Shareholders will vote against (or act by written consent against) any alternative proposals or actions that would impede, interfere with, delay, postpone or adversely affect the transactions contemplated by the Business Combination Agreement, (iii) the Supporting Shareholders will consent to the termination of certain registration and shareholder rights agreements with the Company (with certain exceptions), effective at the First Merger Effective Time, (iv) YS Biopharma and the YSB Shareholders will agree to amend the Shareholders Agreement (as defined in the Business Combination Agreement), effective at the First Merger Effective Time, and (v) the Sponsor will surrender 1,446,525 Summit Class B Ordinary Shares for nil consideration immediately prior to the First Merger Effective Time and exchange all of the remaining Summit Shares held by it into YS Biopharma Ordinary Shares on a one-for-one basis at the First Merger Effective Time.

*Warrant Assignment Agreement*

Concurrently with the execution of the Business Combination Agreement, YS Biopharma, Summit and Continental Stock Transfer & Trust Company, the warrant agent to Summit (the “Warrant Agent”), entered into a warrant assignment agreement (the “Warrant Assignment Agreement”) to amend such warrant agreement (the “Warrant Agreement”), dated June 8, 2021, by and between Summit and the Warrant Agent, pursuant to which Summit assigns and delegates to YS Biopharma all of its rights, interests, and obligations in and under the Warrant Agreement, effective as of the First Merger Effective Time.

*Forward Purchase Agreements*

Prior to Summit’s IPO, Summit entered into forward purchase agreements (collectively, the “Forward Purchase Agreements”) with each of Snow Lake Capital (HK) Limited and the Valliance Fund (collectively, the “Forward Purchase Investors”). The Forward Purchase Agreements provide for (i) the transfer of an aggregate of 375,000 Founder Shares from the Sponsor to the Forward Purchase Investors for nil cash consideration prior to the IPO and (ii) the purchase by the Forward Purchase Investors of an aggregate of 3,000,000 Summit Class A Ordinary Shares, plus an aggregate of 750,000 redeemable warrants to purchase Summit Class A Ordinary Shares at \$11.50 per share, for an aggregate purchase price of \$30,000,000 in a private placement to close concurrently with the closing of Summit’s initial business combination, which will be the consummation of the Transactions. The Forward Purchase Investors’ subscription obligations under the Forward Purchase Agreements do not depend on whether any Summit Class A Ordinary Shares are redeemed by Summit’s public shareholders. Proceeds received from the Forward Purchase Investors under the Forward Purchase Agreements will count towards the Available Closing Cash Amount, which is required to be not less than \$30,000,000 under the Business Combination Agreement. The Forward Purchase Investors have also agreed to vote all Summit Shares held by them in favor of Summit’s initial business combination if Summit seeks shareholder approval of such transaction.

The Summit Board obtained a fairness opinion from ValueScope which stated that the consideration being paid in the Business Combination was fair, from a financial point of view, to Summit Shareholders as a group (as opposed to only the shareholders unaffiliated with the Sponsor or its affiliates). For more information about the Opinion of Summit’s Financial Advisor, see the section entitled “The Business Combination Proposal — Summary of Valuation Analysis and Opinion of Financial Advisor to the Summit Board” in this proxy statement/prospectus.

***The Summit Board’s Reasons for the Approval of the Business Combination***

Summit was formed to effect a merger, share exchange, asset acquisition, share purchase, reorganization or similar business combination with one or more businesses or entities. As described above, the Summit Board sought to do so by using the networks and industry experience of both the Sponsor, the Summit Board, and Summit management to identify and acquire one or more businesses.

In evaluating the transaction with YS Biopharma, the Summit Board consulted with Cooley, its legal counsel, ValueScope, its independent financial advisor, and Ogier, its legal counsel as to Cayman Islands law, and considered a number of factors. In particular, the Summit Board considered, among other things, the following factors, although not weighted or in any order of significance:

- *YS Group’s marketed rabies vaccine with track record of commercialization and significant revenue potential.* YS Group is a biopharmaceutical company with innovative technology and a revenue-generating marketed product with robust growth potential. Its YSJA™ rabies vaccine is the first aluminum-free lyophilized rabies vaccine launched in China, according to the F&S Report, and approximately 97 million doses have been administered to patients for post-exposure protection against rabies. YSJA™ rabies vaccine has demonstrated critical advantages in product characteristics and manufacturing, which makes it attractive for commercialization. As an early entrant in the rabies vaccine industry with a marketed product and an established distribution network, the Summit Board believes that YS Group is well-positioned to capture the fast-growing and vast market in China, which fits Summit’s business combination criteria as a target in the healthcare and pharmaceutical industry with a strong China nexus to benefit from the growing consumption power of Chinese patients and greater affordability driven by innovation.



- YS Group's next-generation product candidate, PIKA rabies vaccine with accelerated regimen and broad protection against multiple virus strains leads to potentially elevated standard of care and favorable and promising market outlook.* YS Group is developing its next-generation product candidate, PIKA rabies vaccine featuring accelerated regimen and broad protection against multiple virus strains. PIKA rabies vaccine is a clinical-stage product candidate. The clinical studies to date have shown that PIKA rabies vaccine can be used under an accelerated regimen, which achieves protective level of neutralizing antibodies as early as seven days post vaccination and elicit more robust immunogenic response compared to that of the control arm vaccine, which is a widely used commercially available vaccine. The Summit Board believes that PIKA rabies vaccine, if approved, enables YS Group to capture the future rabies vaccines market demand in emerging markets with its competitive advantages.
- YS Group's strong research and development capabilities underpinned by innovative PIKA immunomodulating technology platform.* YS Group has built its business upon strong in-house research and development capabilities. Its in-house developed PIKA immunomodulating technology platform has the potential to generate innovative vaccines. YS Group has developed its PIKA immunomodulating technology platform to empower a pipeline of vaccines and therapeutic biologics. The Summit Board believes YS Group's strong R&D and product innovation capability ensures that its vaccines and therapeutic biologics products remain differentiated from those of its peers and creates entry barriers.
- YS Group's robust portfolio of innovative vaccines and therapeutic biologics to drive sustainable value creation.* Leveraging its PIKA immunomodulating technology platform, YS Group has a robust portfolio of innovative product candidates to address the unmet needs in preventing and/or treating infectious diseases and cancer, including (1) four product candidates under various clinical development stages, including PIKA rabies vaccine, PIKA recombinant COVID-19 vaccine, PIKA YS-ON-001 and PIKA YS-HBV-001, among which PIKA rabies vaccine and PIKA YS-ON-001 are categorized under Category I drugs by National Medical Products Administration of the PRC ("NMPA"), which are drugs that have a new and clearly defined structure, pharmacological property and apparent clinical value and have not been marketed anywhere in the world, and (2) four preclinical stage product candidates targeting HBV, influenza, rabies and cancer with enormous medical demand. The Summit Board believes that the comprehensive portfolio of product candidates with commercialization potential will allow YS Group to diversify its revenue sources, sustain its growth and strengthen its competitive advantages.
- YS Group's established clinical development and manufacturing capability to prepare product launch.* The development of adjuvanted vaccines is a specialized and sophisticated field in the biotechnology industry, and YS Group's clinical team has built up first-hand experience in adjuvant selection, dose optimization, study design and pharmaco-vigilance, all of which are crucial to the successful development and application of adjuvants. The manufacture of vaccines is a complex and lengthy process which directly determines the quality and safety and thus the commercial success of vaccine products. The capability to manufacture vaccines on a commercial scale requires in-depth expertise and process know-how, presenting a significant entry barrier against potential competition. YS Group has accumulated extensive and excellent experience in vaccine manufacturing and commercialization, which the Summit Board believes that it will enable YS Group to apply its established clinical development and manufacturing capability to launch its product candidates and new revenue-generating product lines cost-effectively and successfully.
- YS Group has demonstrated commercialization capabilities and established expansive sales network.* With track record in commercializing YSJA™ rabies vaccine, YS Group has demonstrated its commercialization capabilities and established its expansive sales network. As of September 30, 2022, it has built an experienced in-house sales, marketing and patient service team with approximately 51 team members and collaborated with about 126 external service providers to achieve expansive coverage across China. In addition, it has also obtained qualifications from 30 province-level CDCs and had sold more than 16 million doses to approximately 1,625 county-level CDCs. The Summit Board believes that YS Group's product candidates will benefit from the operating leverage enabled by its established and highly scalable commercialization infrastructure, expertise and strategy to rapidly achieve market success.
- Seasoned existing management team with local expertise and global vision and backed by blue-chip investors.* The Summit Board considered that YS Biopharma's management team has comprehensive and complementary capabilities in the vaccine industry, spanning from early research and development, manufacture to commercialization: (i) Mr. Yi Zhang, the founder of YS Group who will be serving as the

chairman of the YS Biopharma after closing of the Business Combination, has over 35 years of experience in China's pharmaceutical industry and has led various successful national research projects; (ii) Mr. Hui Shao, the chief executive officer and director of YS Group who will be serving as the chief executive officer and director of YS Biopharma after closing of the Business Combination, has over 25 years of distinguished scientific and industrial background in biotechnology and pharmaceutical fields ranging from drug discovery, business strategy and product commercialization to private and public capital market in the United States, Europe and Asia, and (iii) YS Group has been led by a strong team of senior management with diversified and complementary skillsets and expertise to support YS Group's transformational growth, and such management team will continue to manage the YS Biopharma and drive its business growth after closing of the Business Combination.

- *Commitment by existing shareholders.* The Summit Board noted that (i) existing YS Biopharma's existing shareholders would not be receiving any cash consideration in connection with the Business Combination; (ii) YS Biopharma's existing shareholders will continue to own approximately 73.5% of YS Biopharma on a fully-diluted basis immediately after the Closing (assuming no redemptions by Summit Public Shareholders and there are no Dissenting Summit Shareholders and the consummation of the Forward Purchase Subscriptions); and (iii) YS Biopharma's existing shareholders will be subject to a 180-day lock-up of the YS Biopharma Ordinary Shares to be held by them immediately after consummation of the Business Combination, subject to limited exceptions and YS Biopharma's right to release certain lock-up obligations. The Summit Board considered these to be strong signs of YS Biopharma's existing shareholders confidence in YS Biopharma, as the combined company after the consummation of the Business Combination, and the benefits to be realized as a result of the Business Combination.
- *Platform for future development and expansion.* The cash proceeds available to YS Biopharma upon closing of the Business Combination and YS Biopharma's access to the public capital markets through the Business Combination are expected to provide YS Group with an optimal platform and strong financial foundation for its further development and business expansion.
- *Reasonable valuation.* The Summit Board considered that the valuation of YS Biopharma under the terms of the Business Combination Agreement, reflected a reasonable valuation for the YS Group's business on an appropriately risk-adjusted basis.
- *Certainty of closing of the Business Combination.* On the basis that (i) the closing of the Business Combination is not subject to regulatory review, report or pre-approval under the applicable anti-trust or competition laws in effect as of the date hereof in the jurisdictions in which YS Biopharma has business operations, thereby reducing the uncertainty and regulatory risk in connection with completing the Business Combination; (ii) the Business Combination Agreement and the transactions contemplated thereby have been approved by the shareholders of YS Biopharma; (iii) pursuant to the Forward Purchase Agreements, the Forward Purchase Investors have agreed to purchase Summit Ordinary Shares and Summit Warrants for an aggregate price equal to \$30,000,000 immediately prior to the First Merger Effective Date, which is sufficient to cover the minimum Available Closing Cash Amount (as defined in the Business Combination Agreement) required to meet a condition to Closing under the Business Combination Agreement; and (iv) pursuant to the Shareholder Support Agreement, the Supporting Shareholders (including, among other persons, the Sponsor and certain existing shareholders of YS Biopharma) have agreed to vote against (or act by written consent against) any alternative proposals or actions that would impede, interfere with, delay, postpone or adversely affect the transactions contemplated by the Business Combination Agreement, the Summit Board expected that the Business Combination has a reasonable likelihood to be consummated pursuant to the terms and conditions of the Business Combination Agreement.
- *Independent directors' role.* The Summit Board is comprised of a majority of independent directors and the audit committee of the Summit Board is comprised entirely of independent directors. On March 16, 2022, HK Yisheng, a subsidiary of YS Biopharma, entered into a facility agreement (the "Facility Agreement") with, among other parties, R-Bridge Investment Three Pte. Ltd, as original lender ("R-Bridge") and R-Bridge Healthcare Fund L.P., as original agent ("R-Bridge Fund"). Mr. Wei Fu, the Honorary Chairman and Senior Advisor of Summit and one of the managers of the Sponsor, is the sole director of R-Bridge and one of the investment committee members of R-Bridge Fund. To manage any potential conflict of interests involving the Sponsor that may arise from the Facility Agreement, the Business Combination Agreement, the related agreements and the transactions contemplated thereby, were reviewed,

assessed and unanimously approved by the audit committee of Summit prior to approval of the Summit Board. In addition, Summit has retained ValueScope as an independent financial advisor to the Summit Board, specifically to provide to the Summit Board a fairness opinion in connection with the Business Combination from a financial point of view.

- *Risks relevant to the Business Combination.* In the course of its deliberations, the Summit Board also considered a variety of risks and uncertainties relevant to the transaction, including, among other things, (i) risks associated with the Business Combination, including risks for Summit’s unaffiliated investors arising from the process of taking a company public by means of a business combination with a special purpose acquisition company, as compared to taking a company public through a traditional initial public offering, such as the absence of due diligence conducted by one or more underwriters that would be subject to liability for any material misstatements or omissions in a registration statement, investors’ inability to recover damages from such underwriters in the event of misstatements and omission in the registration statement, the lack of an effective book-building process, and potentially lower demand, decreased liquidity and increased trading volatility of YS Biopharma’s securities, (ii) risks related to YS Group’s business, (iii) risks related to doing business in China, (iv) risks associated with the liquidation of Summit and (v) risks associated with post-closing corporate governance.

The Summit Board believes that the Business Combination is fair, advisable and in the best interests of Summit and the Summit Shareholders and is a product of arm’s-length negotiations among the parties. In addition, the Summit Board obtained a fairness opinion from ValueScope which stated the consideration being paid in the Business Combination was fair to Summit from a financial point of view. The overall assumptions in the ValueScope fairness opinion assumed the completion of the Business Combination as originally contemplated. These factors are discussed in greater detail in the section entitled “The Business Combination Proposal — Summit’s Board Reasons for the Approval of the Business Combination.”

For a more complete description of Summit Board’s reasons for approving the Business Combination, including other factors and risks considered by the Summit Board, see the section entitled “The Business Combination Proposal — The Summit Board’s Reasons for the Approval of the Business Combination.”

#### **The Merger Proposal (page 184)**

The shareholders of Summit will vote on a separate proposal to authorize the Merger and the Plan of First Merger by way of a special resolution under the Cayman Islands Companies Act. For more information, see the section entitled “The Merger Proposal.”

#### **The Adjournment Proposal (page 185)**

If, based on the tabulated vote, there are insufficient votes at the time of the Extraordinary General Meeting to authorize Summit to consummate the Merger or the Business Combination or if holders of Summit Public Shares have elected to redeem an amount of Summit Public Shares such that the minimum available cash condition contained in the Business Combination Agreement would not be satisfied, the chairman of the meeting may (and Summit is required under the Business Combination Agreement to) submit a proposal to adjourn the Extraordinary General Meeting to a later date or dates, if necessary, to permit further solicitation of proxies. For more information, see the section entitled “The Adjournment Proposal.”

#### **Date, Time and Place of Extraordinary General Meeting of Summit Shareholders (page 141)**

The Extraordinary General Meeting of the shareholders of Summit shall be held at 9:00 a.m. Eastern Time, on March 1, 2023 at 35th Floor, Two Exchange Square, 8 Connaught Place Central, Hong Kong and virtually at <https://www.cstproxy.com/summithealthcarespac/2023>, to consider and vote upon the Business Combination Proposal, the Merger Proposal, and if presented, the Adjournment Proposal.

#### **Record Date; Outstanding Shares; Shareholders Entitled to Vote (page 141)**

Summit has fixed the close of business on February 2, 2023 as the “Record Date” for determining Summit Shareholders entitled to notice of and to attend and vote at the Extraordinary General Meeting. If your Summit Shares are held in “street name” or are in a margin or similar account, you should contact your broker

or bank to ensure that votes related to the Summit Shares you beneficially own are properly counted. Summit Warrants do not have voting rights. As of the close of business on the Record Date, there were 20,000,000 Summit Public Shares and 5,750,000 Founder Shares outstanding and entitled to vote. All of the Founder Shares are held by the Sponsor, Summit's independent directors and the Forward Purchase Investors. Each Summit Share is entitled to one vote per share at the Extraordinary General Meeting.

#### **Quorum; Votes Required (page 142)**

A quorum is the minimum number of Summit Shares that must be present to hold a valid meeting. A quorum shall be present at the Extraordinary General Meeting if one or more shareholders holding in the aggregate not less than one-third of the total issued and outstanding Summit Shares present in person physically or by virtual attendance or represented by proxy and entitled to vote at the Extraordinary General Meeting. As of the Record Date, 8,583,334 Summit Shares would be required to achieve a quorum.

The proposals presented at the Extraordinary General Meeting shall require the following votes:

- **Proposal No.1—Business Combination Proposal**—The approval of the Business Combination Proposal will require an ordinary resolution under Cayman Islands law and the Summit Articles, being the affirmative vote of the holders of a majority of the issued and outstanding Summit Shares present in person physically or by virtual attendance or represented by proxy and entitled to vote at the Extraordinary General Meeting.
- **Proposal No.2—Merger Proposal**—The approval of the Merger Proposal will require a special resolution under Cayman Islands law and the Summit Articles, being the affirmative vote of the holders of at least two-thirds of the issued and outstanding Summit Shares present in person physically or by virtual attendance or represented by proxy and entitled to vote at the Extraordinary General Meeting.
- **Proposal No.3—Adjournment Proposal**—The approval of the Adjournment Proposal, if presented, will require an ordinary resolution under Cayman Islands law and the Summit Articles, being the affirmative vote of the holders of a majority of the issued and outstanding Summit Shares present in person physically or by virtual attendance or represented by proxy and entitled to vote at the Extraordinary General Meeting.

#### **Redemption Rights (page 143)**

Pursuant to the Summit Articles, in connection with the completion of the Business Combination, Summit Public Shareholders may elect to have their Summit Public Shares redeemed for cash at the applicable redemption price per share calculated in accordance with the Summit Articles. For illustrative purposes, as of February 2, 2023, the Record Date, this redemption amount would have amounted to approximately \$10.1 per share. In this proxy statement/prospectus, these rights to demand redemption of the Summit Public Shares are sometimes referred to as "redemption rights." Summit Public Shareholders may elect to exercise such redemption rights, regardless of whether they vote or, if they do vote, irrespective of whether they vote for or against the Business Combination Proposal, the Merger Proposal or the Adjournment Proposal.

If you are a Summit Public Shareholder and wish to exercise your right to have your Summit Public Shares redeemed, you must:

- submit a written request to Continental, Summit's transfer agent, in which you (i) request that Summit redeem all or a portion of your Summit Public Shares for cash, and (ii) identify yourself as the beneficial holder of the Summit Public Shares and provide your legal name, phone number and address;
- and either tender your share certificates (if any) to Continental, Summit's transfer agent, or deliver your Summit Public Shares to the transfer agent electronically using The Depository Trust Company's DWAC (Deposit/Withdrawal at Custodian) System.

**Summit Public Shareholders must complete the procedures for electing to redeem their Summit Public Shares in the manner described above prior to 5:00 p.m. on February 27, 2023 (two business days prior to the vote at the Extraordinary General Meeting) in order for their Summit Ordinary Shares to be redeemed. (page 144)**

There is a nominal cost associated with the above-referenced tendering process and the act of certificating the shares or delivering them through the DWAC system. The transfer agent will typically charge the tendering broker a nominal amount and it would be up to the broker whether or not to pass this cost on to the redeeming

shareholder. In the event the Business Combination is not consummated this may result in an additional cost to shareholders for the return of their shares.

**If you hold the Summit Public Shares in “street name,” you will have to coordinate with your broker or bank to have the Summit Public Shares you beneficially own certificated and delivered electronically.**

**Holders of Units must elect to separate the Units into the underlying Summit Public Shares and Summit Warrants prior to exercising redemption rights with respect to the Summit Public Shares. If holders hold their Units in an account at a brokerage firm or bank, holders must notify their broker or bank that they elect to separate the Units into the underlying Summit Public Shares and Summit Warrants, or if a holder holds Units registered in its own name, the holder must contact Continental, Summit’s transfer agent, directly and instruct it to do so. The redemption rights include the requirement that a holder must identify itself in writing as a beneficial holder and provide its legal name, phone number and address to Continental in order to validly redeem its Summit Public Shares.**

If the Business Combination is not consummated, the Summit Public Shares will not be redeemed and instead will be returned to the respective holder, broker or bank. In such case, Summit Shareholders may only share in the assets of the trust account upon the liquidation of Summit. This may result in Summit Shareholders receiving less than they would have received if the Business Combination was completed and they had exercised redemption rights in connection therewith due to potential claims of creditors.

If a Summit Public Shareholder satisfies the requirements for exercising redemption rights with respect to all or a portion of the Summit Public Shares he, she or it holds and the Business Combination is consummated, Summit will redeem such Summit Public Shares for a per-share price, payable in cash, equal to the aggregate amount then on deposit in the Trust Account calculated as of two business days prior to the consummation of the Business Combination, including interest earned on the Trust Account (net of taxes paid or payable, if any), divided by the then issued Summit Public Shares, provided that Summit shall not repurchase Summit Public Shares in an amount that would cause Summit's net tangible assets to be less than \$5,000,001. There are currently no owed but unpaid income taxes on the funds in the Trust Account. However, the proceeds deposited in the trust account could become subject to the claims of Summit's creditors, if any, which would have priority over the claims of Summit Shareholders. Therefore, the per share distribution from the trust account in such a situation may be less than originally expected due to such claims. It is expected that the funds to be distributed to Summit Public Shareholders electing to redeem their Summit Public Shares shall be distributed promptly after the consummation of the Business Combination.

Notwithstanding the foregoing, a Summit Public Shareholder, together with any affiliate of such holder and any person with whom such holder is acting in concert or as a “group” (as defined under Section 13(d)(3) of the Exchange Act), may not seek to have more than 15% of the aggregate Summit Public Shares redeemed without the prior consent of Summit. Additionally, under the Summit Articles, in no event will Summit redeem Summit Public Shares in an amount that would cause its net tangible assets to be less than \$5,000,001, such that Summit is not subject to the SEC’s “penny stock” rules.

Any request for redemption, once made by a Summit Public Shareholder, may be withdrawn at any time up to two business days prior to the vote at Extraordinary General Meeting. After this time, a request for redemption may not be withdrawn once unless the Summit Board determines (in its sole discretion) to permit the withdrawal of such redemption request (which it may do in whole or in part). Such a request must be made by contacting Continental, Summit’s transfer agent, at the phone number or address set out elsewhere in this proxy statement/prospectus.

No request for redemption shall be honored unless the holder’s share certificates (if any) or shares have been delivered (either physically or electronically) to Continental, Summit’s transfer agent, in the manner described above, at least two business days prior to the vote at the Extraordinary General Meeting.

If you exercise your redemption rights, then you shall be exchanging your Summit Public Shares for cash and shall not be entitled to receive any YS Biopharma Ordinary Shares in respect of such redeemed shares upon consummation of the Business Combination.

If you are a holder of Summit Public Shares and you exercise your redemption rights, such exercise shall not result in the loss of any Summit Warrants that you may hold. Assuming 100% redemption, the Summit

Warrants owned by such redeeming Summit Public Shareholders will be worth approximately \$2.8 million in the aggregate based on the closing price of Summit Warrants on the Record Date of \$0.2774.

The closing price of Summit Public Shares on the Record Date was \$10.12. The cash held in the Trust Account on such date was approximately \$202 million (approximately \$10.1 per Summit Public Share). Prior to exercising redemption rights, Summit Public Shareholders should verify the market price of Summit Public Shares as they may receive higher proceeds from the sale of their Summit Public Shares in the public market than from exercising their redemption rights if the market price per share is higher than the redemption price. Summit cannot assure its shareholders that they shall be able to sell their Summit Public Shares in the open market, even if the market price per share is higher than the redemption price stated above, as there may not be sufficient liquidity in its securities when its shareholders wish to sell their shares.

#### **Appraisal or Dissenters' Rights (page 145)**

Holders of record of Summit Shares may have appraisal rights in connection with the Business Combination under the Cayman Islands Companies Act. In this proxy statement/prospectus, these appraisal or dissent rights are sometimes referred to as "Dissent Rights". Holders of record of Summit Shares wishing to exercise such Dissent Rights and make a demand for payment of the fair value for his, her or its Summit Shares must give written objection to the First Merger to Summit prior to the shareholder vote at the Extraordinary General Meeting to approve the First Merger and follow the procedures set out in Section 238 of the Cayman Islands Companies Act, noting that any such dissenter rights may subsequently be lost and extinguished pursuant to Section 239 of the Cayman Islands Companies Act which states that no such dissenter rights shall be available in respect of shares of any class for which an open market exists on a recognized stock exchange or recognized interdealer quotation system at the expiry date of the period allowed for written notice of an election to dissent provided that the merger consideration constitutes inter alia shares of any company which at the effective date of the merger are listed on a national securities exchange. The Business Combination Agreement provides that, if any Summit shareholder exercises Dissent Rights then, Summit shall in accordance with Section 238(4) of the Cayman Islands Companies Act, promptly give written notice of the authorization of the First Merger (the "Authorization Notice") to each such Summit shareholder who has made a written objection, and unless Summit and YS Biopharma elect by agreement in writing otherwise, no party shall be obligated to commence the consummation of the First Merger and the Plan of First Merger shall not be filed with the Registrar of Companies in the Cayman Islands, until at least twenty days shall have elapsed since the date on which the Authorization Notice is given (being the period allowed for written notice of an election to dissent under Section 238 of the Cayman Islands Companies Act, as referred to in Section 239 of the Cayman Islands Companies Act). Summit believes that such fair value would equal the amount that Summit Shareholders would obtain if they exercised their redemption rights as described herein. A Summit shareholder which elects to exercise Dissent Rights must do so in respect of all of the Summit Shares that person holds and will lose their right to exercise their redemption rights as described herein. See the section entitled "Extraordinary General Meeting of Summit Shareholders — Appraisal Rights under the Cayman Islands Companies Act."

Summit Shareholders are recommended to seek their own advice as soon as possible on the application and procedure to be followed in respect of the appraisal rights under the Cayman Islands Companies Act.

#### **Proxy Solicitation (page 146)**

Proxies may be solicited by mail, telephone or in person. Summit has engaged Advantage Proxy, Inc. ("Advantage") to assist in the solicitation of proxies.

If a shareholder grants a proxy, it may still vote its Summit Shares at the Extraordinary General Meeting by attending the Extraordinary General Meeting virtually by visiting <https://www.cstproxy.com/summithealthcarespac/2023>, entering the control number on its proxy card and voting via the web portal during the Extraordinary General Meeting webcast. A shareholder may also change its vote by submitting a later-dated proxy as described in the section entitled "Extraordinary General Meeting of Summit Shareholders — Revoking Your Proxy."

#### **Interests of Summit's Directors, Officers and the Sponsor in the Business Combination (page 180)**

When considering the Summit Board's recommendation to vote in favor of approving the Business Combination Proposal and the Merger Proposal, Summit Shareholders should keep in mind that Sponsor and

Summit's directors and officers have interests in such proposals that are different from, or in addition to (and which may conflict with), those of Summit Shareholders and warrant holders generally. These interests include, among other things, the interests listed below:

- the fact that the Sponsor and Summit's directors and officers have agreed to waive their redemption rights with respect to their Summit Class B Ordinary Shares in connection with the completion of the proposed Business Combination;
- the fact that the Sponsor and certain of Summit's directors are anticipated to hold 3.46% of the equity interests and 3.46% of the voting power in YS Biopharma immediately after the Business Combination, assuming no redemptions by Summit Public Shareholders and there are no Dissenting Summit Shareholders (or 4.26% of the equity interest and 4.26% of the voting power in YS Biopharma immediately after the Business Combination, assuming 100% redemption by Summit Public Shareholders);
- the fact that the Sponsor paid an aggregate of \$25,000 for the 5,750,000 Founder Shares currently owned by the Sponsor and Summit's directors and such securities will have a significantly higher value after the Business Combination. As of February 2, 2023, the most recent practicable date prior to the date of this proxy statement/prospectus, the aggregate market value of these shares, if unrestricted and freely tradable, would be \$58,190,000, based upon a closing price of \$10.12 per Summit Public Share on Nasdaq. The Founder Shares are expected to be worthless if the Business Combination or another business combination is not completed by the Final Redemption Date because the holders are not entitled to participate in any redemption or distribution of proceeds in the trust account with respect to such shares;
- the fact that Sponsor paid \$6,000,000 to purchase an aggregate of 6,000,000 Summit Private Warrants, each exercisable to purchase one Summit Public Share at \$11.50, subject to adjustment, at a price of \$1.00 per warrant, and those warrants would be worthless—and the entire \$6,000,000 warrant investment would be lost—if the Business Combination or another business combination is not consummated by the Final Redemption Date. As of February 2, 2023, the most recent practicable date prior to the date of this proxy statement/prospectus, the aggregate market value of these Summit Private Warrants, if unrestricted and freely tradable, would be \$1,664,400, based upon a closing price of \$0.2774 per Summit Public Warrant on Nasdaq;
- the fact that, given the differential in the purchase price that the Sponsor and certain of Summit's directors paid for the Founder Shares and the purchase price that the Sponsor paid for the Summit Private Warrants as compared to the price of the Summit Public Shares and Summit Public Warrants and the substantial number of YS Biopharma Ordinary Shares that the Sponsor and these directors will receive upon conversion of the Founder Shares and Summit Private Warrants, the Sponsor and these directors can earn a positive return on their investment, even if other Summit Shareholders have a negative return on their investment in YS Biopharma;
- the fact that Sponsor and Summit's directors and officers have agreed to waive their rights to liquidating distributions from the trust account with respect to any Founder Shares held by them if Summit fails to complete a business combination by the Final Redemption Date;
- the fact that the Business Combination Agreement provides for the continued indemnification of Summit's directors and officers and the continuation of Summit's directors' and officers' liability insurance after the Business Combination (i.e., a "tail policy");
- the fact that Sponsor and Summit's directors and officers and their affiliates are entitled to reimbursement of out-of-pocket expenses incurred by them in connection with certain activities on Summit's behalf, such as identifying and investigating possible business targets and business combinations. However, if Summit fails to consummate a business combination within the required period, they will not have any claim against the trust account for reimbursement. Accordingly, Summit may not be able to reimburse these expenses if the Business Combination or another business combination is not completed by the Final Redemption Date. That being said, the Sponsor and Summit's directors and officers and their affiliates had not incurred any unpaid reimbursable expenses as of the date of this proxy statement/prospectus;
- the fact that the Sponsor will benefit from the completion of a business combination and may be incentivized to complete an acquisition of a less favorable target company or on terms less favorable to shareholders rather than liquidate;

- the fact that if the Trust Account is liquidated, including in the event Summit is unable to complete a business combination by the Final Redemption Date, the Sponsor has agreed to indemnify Summit to ensure that the proceeds in the Trust Account are not reduced below \$10.00 per Summit Public Share, or such lesser per Summit Public Share amount as is in the Trust Account on the liquidation date, by the claims of prospective target businesses with which Summit has discussed entering into a transaction agreement or claims of any third party for services rendered or products sold to Summit (other than Summit's independent registered public accounting firm), but only if such a vendor or target business has not executed a waiver of any and all rights to seek access to the Trust Account;
- the fact that the Summit Articles contain a waiver of the corporate opportunity doctrine. With such waiver, there could be business combination targets that maybe suitable or worth consideration for a combination with Summit but not offered due to a Summit director's duties to another entity. Summit does not believe that the potential conflict of interest relating to the waiver of the corporate opportunities doctrine in the Summit Articles impacted its search for an acquisition target and Summit was not prevented from reviewing any opportunities as a result of such waiver;
- the fact that HK Yisheng, a subsidiary of YS Biopharma, entered into the Facility Agreement with, among other parties, R-Bridge, as original lender, and R-Bridge Fund, as original agent. Mr. Wei Fu, the Honorary Chairman and Senior Advisor of Summit and one of the managers of the Sponsor, is the sole director of R-Bridge and one of the investment committee members of R-Bridge Fund. Pursuant to the Facility Agreement, (i) R-Bridge made available to YS Biopharma a term loan facility in an aggregate amount of \$40,000,000, all of which was outstanding as of the date hereof; (ii) the facility and commitment under the Facility Agreement will be immediately cancelled and all of the outstanding loans, together with accrued interest and other amounts will become immediately due and payable if a listing, admission to trading, flotation or public offering of any shares of YS Biopharma (including upon or as a result of any direct or indirect merger, consolidation or takeover) has not occurred by October 31, 2023 or a later day as determined under the Facility Agreement; and (iii) consents from the lender(s) whose commitments aggregate more than 2/3 of the total amount then outstanding are required to approve certain transactions, including the Business Combination Agreement; and
- the fact that Mr. Bo Tan, a current director of Summit, is expected to become a director of YS Biopharma and in such case would be compensated as a director of YS Biopharma.

The Sponsor has agreed to, among other things, vote all of their Summit Shares in favor of the proposals being presented at the Extraordinary General Meeting in connection with the Business Combination and waive their redemption rights with respect to their Summit Shares in connection with the consummation of the Business Combination. As of the date of this proxy statement/prospectus, on an as-converted basis, the Sponsor and certain Summit directors own, collectively, approximately 21% of the issued and outstanding Summit Shares.

The existence of financial and personal interests of one or more of Summit's directors and officers results in conflicts of interest on the part of such director(s) between what he, she, or they may believe is in the best interests of Summit and what he, she, or they may believe is best for himself, herself, or themselves in determining to recommend that shareholders vote for the proposals.

For more information on interests of Summit's directors and officers, see the section entitled "The Business Combination Proposal—Interests of Summit's Directors, Officers and the Sponsor in the Business Combination."

#### **Material U.S. Federal Income Tax Consequences (page 350)**

As described in the section entitled "Material Tax Considerations—U.S. Federal Income Tax Considerations to U.S. Holders—Tax Treatment of the Mergers," to qualify as a Reorganization, the Mergers must satisfy certain requirements, some of which are based on factual determinations, and actions or events after the Mergers could adversely affect such qualification. One such requirement is that the acquiring corporation, directly or indirectly through certain controlled corporations, either continue a significant line of the acquired corporation's historic business or use a significant portion of the acquired corporation's historic business assets in a business, in each case, within the meaning of U.S. Treasury Regulations Section 1.368-1(d).



However, due to the absence of guidance bearing directly on how the above rules apply in the case of an acquisition of a corporation like Summit that holds primarily investment-type assets, the qualification of the Mergers as a Reorganization is subject to significant uncertainty, and is therefore not capable of being the subject of a representation regarding its tax treatment. The closing of the Business Combination is not conditioned upon the receipt of an opinion of counsel that the Mergers will qualify as a Reorganization, and neither Summit nor YS Biopharma intends to request a ruling from the IRS regarding the U.S. federal income tax treatment of the Mergers. Accordingly, no assurance can be given that the IRS will not treat the Mergers as taxable transactions and challenge the qualification of the Mergers as a Reorganization or that a court will not sustain such a challenge by the IRS. U.S. Holders of Summit Securities are urged to consult their tax advisors regarding the proper U.S. federal income tax treatment of the Mergers, including with respect to their qualification as a Reorganization.

If the Mergers were to qualify as a Reorganization, a U.S. Holder generally would not recognize gain or loss on the exchange of Summit Securities for YS Biopharma Securities in the Mergers. However, if any requirement to qualify as a Reorganization is not met, then a U.S. Holder generally will recognize gain or loss in an amount equal to the difference between the fair market value (as of the closing date of the Mergers) of YS Biopharma Ordinary Shares and YS Biopharma Warrants received in the Merger, over such holder's aggregate adjusted tax basis in the corresponding Summit Public Shares and Summit Public Warrants surrendered by such holder in the Mergers. Even if the requirements to qualify as a Reorganization are satisfied, U.S. Holders may be required to recognize gain (but not loss) in the Mergers under the PFIC rules, as described in more detail in the section entitled "Material Tax Considerations — U.S. Federal Income Tax Considerations to U.S. Holders — Passive Foreign Investment Company Rules."

If a U.S. Holder elects to redeem its Summit Public Shares for cash, the treatment of the transaction for U.S. federal income tax purposes will depend on whether the redemption qualifies as a sale or exchange of the Summit Public Shares under Section 302 of the Code. If the redemption qualifies as such a sale or exchange, such U.S. Holder generally will recognize gain or loss in an amount equal to the difference, if any, between the amount realized on the redemption and such U.S. Holder's adjusted tax basis in the Summit Public Shares surrendered by such U.S. Holder in the redemption. There may be certain circumstances, however, in which the redemption may be treated as a distribution for U.S. federal income tax purposes, depending on the amount of Summit Public Shares that such U.S. Holder owns or is deemed to own (including through the ownership of Summit Public Warrants) after the redemption.

For more information, see the section entitled "Material Tax Considerations — U.S. Federal Income Tax Considerations to U.S. Holders."

#### **Anticipated Accounting Treatment (page 181)**

Notwithstanding the legal form of the Business Combination pursuant to the Business Combination Agreement, the Business Combination will be accounted as recapitalization. Summit will be treated as the "acquired" company and YS Biopharma will be treated as the acquirer for financial statement reporting purposes. YS Biopharma has been determined to be the accounting acquirer based on evaluation of the following facts and circumstances:

- YS Biopharma's shareholders will have the largest voting interest in the post-combination company under both the no redemption and 100% redemption scenarios;
- YS Biopharma's shareholders will have the ability to nominate at least a majority of the members of the board of directors of the post-combination company;
- YS Biopharma's senior management is the senior management of the post-combination company; and
- YS Biopharma is the larger entity, in terms of YS Biopharma's substantive operations and employee base.

#### **Comparison of Rights of Shareholders of Summit and Shareholders of YS Biopharma (page 367)**

If the Business Combination is successfully completed, holders of Summit Shares will become holders of YS Biopharma Ordinary Shares and their rights as shareholders will be governed by YS Biopharma's constitutional documents. For more information, see the section entitled "Comparison of Rights of YS Biopharma Shareholders and Summit Shareholders" on page 367 of this proxy statement/prospectus.

**Regulatory Matters (page 181)**

The Business Combination and the transactions contemplated by the Business Combination Agreement are not subject to any federal or state regulatory requirement or approval, except for the filings and registration with the Cayman Islands Registrar of Companies and the payment of the applicable fees under the Cayman Islands Companies Act necessary to effectuate the Business Combination.

YS Group has a substantial business and operation in China and thus is exposed to legal and operational risks associated with its operations in China. As of the date of this proxy statement/prospectus, YS Group has obtained all requisite license, permission or approvals for its current business operations in China and none of such license, permission or approvals current in effect have been withdrawn or revoked by the competent governmental authorities. The PRC government has significant authority to exert influence on the ability of a company with operations in China, including YS Group, to conduct its business. Changes in China's economic, political or social conditions or government policies could materially and adversely affect its business and results of operations. These China-related risks could result in a material change in its operations and/or the value of YS Biopharma's securities, or could significantly limit or completely hinder the ability of YS Biopharma to offer or continue to offer securities to investors and cause the value of such securities to significantly decline or become worthless. In particular, recent policy statements and regulatory actions by the PRC government, such as those related to human genetic resources, data privacy and biopharmaceutical and vaccine business, may adversely impact YS Biopharma's ability to conduct its business and R&D activities, accept foreign investments, or list on a U.S. or other foreign stock exchange, which may cause the securities of YS Biopharma to be prohibited from trading or to be delisted from the Nasdaq or any other U.S. stock exchange. Furthermore, the PRC government has recently indicated an intent to exert more oversight and control over overseas securities offerings and other capital markets activities and foreign investment in China-based companies like YS Group. Any such action, once taken by the PRC government, could significantly limit or completely hinder YS Biopharma's ability to offer or continue to offer securities to investors and cause the value of such securities to significantly decline or in extreme cases, become worthless. See the section entitled "Risk Factors — Risks Related to Doing Business in China."

On November 14, 2021, the Cyberspace Administration of China (the "CAC") published the Regulations on Network Data Security Management (Draft for Comment), under which data processors shall be subject to cybersecurity review if they process personal information of more than one million persons and aiming to list on foreign stock markets, or the data processing activities influence or may influence national security. The CAC, together with 12 other PRC regulatory authorities, released the 2022 Cybersecurity Review Measures, which came into effect on February 15, 2022, pursuant to which operators of critical information infrastructure procuring network products and services, and online platform operators carrying out data processing activities, in each case that affect or may affect national security, shall conduct a cybersecurity review pursuant to the provisions therein. In addition, online platform operators possessing personal information of more than one million users seeking to be listed on foreign stock markets must apply for a cybersecurity review. YS Biopharma believes that neither YS Biopharma nor any of its PRC Subsidiaries is subject to cybersecurity review, reporting or other permission requirements by the CAC under the applicable PRC cybersecurity laws and regulations with respect to the offering of its securities or the business operations of its PRC Subsidiaries, because neither YS Biopharma nor any of its PRC Subsidiaries qualifies as a critical information infrastructure operator or online platform, or has conducted any data processing activities that affect or may affect national security or holds personal information of more than one million users. However, as PRC governmental authorities have significant discretion in interpreting and implementing statutory provisions and there remains significant uncertainty in the interpretation and enforcement of relevant PRC cybersecurity laws and regulations, there is no assurance that YS Biopharma or any of its PRC Subsidiaries will not be deemed to be subject to PRC cybersecurity review or that YS Biopharma or any of its PRC Subsidiaries will be able to pass such review. In addition, YS Biopharma and its PRC Subsidiaries could become subject to enhanced cybersecurity review or investigations launched by PRC regulators in the future pursuant to new laws, regulations or policies. Any failure or delay in the completion of the cybersecurity review procedures or any other non-compliance with applicable laws and regulations may result in fines, suspension of business, website closure, revocation of business licenses or other penalties, as well as reputational damage or legal proceedings or actions against YS Biopharma or its PRC Subsidiaries, which may have a material adverse effect on their business, financial condition or results of operations.

On December 24, 2021, the CSRC published the Provisions of the State Council on the Administration of Overseas Securities Offering and Listing by Domestic Companies (Draft for Comments), and Administrative Measures for the Filing of Overseas Securities Offering and Listing by Domestic Companies (Draft for Comments), or, collectively, the Draft Overseas Listing Regulations, which require that China-based companies seeking to offer and list securities in overseas markets complete certain filing procedures with the CSRC. The Draft Overseas Listing Regulations were released only for public comments and their provisions and anticipated adoption date are subject to changes and their interpretation and implementation remain uncertain. The Draft Overseas Listing Regulations are not clear as to whether companies like YS Group that have already submitted an application for an initial public offering to overseas regulators but have not yet completed the offering shall be subject to such filing procedures. As of the date of this proxy statement/prospectus, no formal inquiry, notice, warning, sanction, or any regulatory objection from the CSRC with respect to this Business Combination was received.

**Recommendation to Shareholders (page 141)**

The Summit Board believes that each of the proposals to be presented at the Extraordinary General Meeting is fair to, and in the best interests of, Summit and unanimously recommends that its shareholders vote “FOR” the Business Combination Proposal, “FOR” the Merger Proposal and “FOR” the Adjournment Proposal, if presented.

**Risk Factor Summary (page 60)**

In evaluating the proposals to be presented at the Extraordinary General Meeting of the shareholders of Summit, a shareholder should carefully read this proxy statement/prospectus and especially consider the factors discussed in the section titled “Risk Factors,” a summary of which is set forth below. The occurrence of one or more of the events or circumstances described below, alone or in combination with other events or circumstances, may adversely affect Summit’s ability to effect the Business Combination, and may have an adverse effect on the business, cash flows, financial condition and results of operations of Summit prior to the Business Combination and that of YS Biopharma subsequent to the Business Combination.

***Risks Related to YS Group’s Business and Products (page 60)***

There are various risks related to YS Group’s business and operations, which include, but are not limited to:

- YS Group depends on its current marketed rabies vaccine product to generate substantially all of its revenue in the near term. YS Group’s previous operating history of manufacturing and commercializing vaccines may not provide an adequate basis to judge the viability of its business, the effectiveness of its management and its future profitability and prospects in respect of its marketed product.
- YS Group faces substantial competition. Its competitors may discover, develop or commercialize products before, or more successfully than, YS Group do, or develop therapies that are more advanced or effective than ours, which may adversely affect YS Group’s financial condition and its ability to successfully market or commercialize its marketed product and product candidates.
- YS Group’s product candidates, once commercialized, may compete with its existing marketed product.
- If the rabies vaccine industry in China does not grow as expected or declines, YS Group’s ability to expand its business and results of operations could be materially and adversely affected.
- The commercial success of any of YS Group’s marketed product and product candidates depends on its degree of market acceptance by end-users, CDCs, KOLs and others related to the vaccine or disease prevention industry.
- The biopharmaceutical industry is highly regulated. The relevant regulations and policies are complex and regional and subject to changes from time to time. YS Group’s ability to obtain and maintain these regulatory approvals is uncertain. Any change in government regulation and policy may place additional burdens on YS Group’s business and have a material adverse effect on YS Group’s financial condition and results of operations.

- YS Group’s marketed product and product candidates may become subject to unfavorable pricing regulations, third-party reimbursement practices or healthcare reform initiatives, which could harm YS Group’s business.
- YS Group currently relies on the manufacturing facilities for the marketed product and are still in the process of developing additional facilities at other sites. Any disruption of YS Group’s current and new facilities or their failure to meet GMP regulatory compliance or other regulatory requirements may have a material adverse effect on YS Group’s business, financial condition and results of operations.
- Failure to manage the normal manufacturing capacity properly may materially and adversely affect YS Group’s revenues and profitability.
- YS Group has incurred significant losses since its inception. YS Group might incur losses or fail to generate sufficient revenue to achieve satisfactory profitability in the future.
- YS Group’s financial prospects depend on the sale of its marketed product, and the successful development and approval of its clinical-stage and preclinical stage product candidates.
- YS Group may need to obtain substantial additional financing to fund its operations, and a failure to obtain necessary capital when needed would force YS Group to delay, limit, reduce or terminate its product development or commercialization efforts.
- The issuance, scope, validity, enforceability and commercial value of YS Group’s patent rights are highly uncertain, and there can be no assurance that any of YS Group’s technology, marketed product or product candidates will be protectable or remain protected by valid and enforceable patents. If YS Group is unable to obtain and maintain patent protection for its marketed product and product candidates, or if the scope of such patent protection obtained is not sufficiently broad, third parties may compete directly against YS Group.
- YS Group’s business, results of operations and financial position could be adversely affected by the ongoing COVID-19 pandemic.

For additional detail on these and other risks, see the section entitled “Risk Factors — Risks Related to YS Group’s Business and Products” beginning on page 60 of this proxy statement/prospectus.

***Risks Related to Doing Business in China (page 100)***

YS Group faces various legal and operational risks associated with doing business in China, which could cause the value of YS Biopharma’s securities to significantly decline or become worthless, and significantly limit or completely hinder its ability to accept foreign investments and offer or continue to offer securities to foreign investors. These risks include, but are not limited to:

- YS Group has a substantial business and operation in China and thus is exposed to legal and operational risks associated with its operations in China. The PRC government has significant authority to exert influence on the ability of a company with operations in China, including YS Group, to conduct its business. Changes in China’s economic, political or social conditions or government policies could materially and adversely affect its business and results of operations. For example, YS Group faces risks associated with regulatory approvals of offshore offerings, anti-monopoly regulatory actions, oversight on cybersecurity and data privacy, as well as the lack of PCAOB inspection on its auditors. On December 16, 2021, the PCAOB issued a report to notify the SEC of its determination that it is unable to inspect or investigate completely PCAOB-registered public accounting firms headquartered in mainland China and Hong Kong without the approval of the Chinese authorities. While YS Biopharma’s auditor, Wei, Wei & Co., LLP, is headquartered in the United States and not subject to such determinations, there is no guarantee that the audit work carried out by Wei, Wei & Co., LLP in collaboration of its China-based offices can be inspected or investigated completely by the PCAOB without such approval. On August 26, 2022, the PCAOB signed a Statement of Protocol with the CSRC and the Ministry of Finance of the People’s Republic of China, taking the first step toward opening access for the PCAOB to inspect and investigate registered public accounting firms headquartered in mainland China and Hong Kong. On December 15, 2022, the PCAOB announced that it was able to secure complete access to inspect and investigate PCAOB registered public accounting firms headquartered in mainland China and Hong Kong completely in 2022. The PCAOB Board vacated its previous 2021 determinations that the PCAOB was unable to inspect or investigate

completely registered public accounting firms headquartered in mainland China and Hong Kong. However, whether the PCAOB will continue to be able to satisfactorily conduct inspections of PCAOB-registered public accounting firms headquartered in mainland China and Hong Kong is subject to uncertainties and depends on a number of factors out of our and our auditor's control. The PCAOB continues to demand complete access in mainland China and Hong Kong moving forward and is making plans to resume regular inspections in early 2023 and beyond, as well as to continue pursuing ongoing investigations and initiate new investigations as needed. The PCAOB has also indicated that it will act immediately to consider the need to issue new determinations with the HFCAA if needed. YS Biopharma could still face the risk of delisting and cease of trading of its securities from a stock exchange or an over-the-counter market in the United States under the Holding Foreign Companies Accountable Act and the securities regulations promulgated thereunder if the PCAOB is unable to inspect and investigate completely registered public accounting firms located in China in 2023 or beyond, or if YS Biopharma otherwise fails to meet the PCAOB's requirements. These China-related risks could result in a material change in its operations and/or the value of YS Biopharma's securities, or could significantly limit or completely hinder the ability of YS Biopharma to offer or continue to offer securities to investors and cause the value of such securities to significantly decline or become worthless. See the section entitled "Risk Factors — Risks Related to Doing Business in China."

- The PRC government has significant oversight and discretion over the conduct of YS Group's business and operations and may intervene with or influence its operations as the government deems appropriate to further regulatory, political and societal goals. Recent policy statements and regulatory actions by the PRC government, such as those related to human genetic data and biopharmaceutical and vaccine business, may adversely impact YS Group's ability to conduct its business and R&D activities, accept foreign investments, or list on a U.S. or other foreign stock exchange, which may cause the securities of YS Biopharma to be prohibited from trading or to be delisted from the Nasdaq or any other U.S. stock exchange. Furthermore, the PRC government has recently indicated an intent to exert more oversight and control over overseas securities offerings and other capital markets activities and foreign investment in China-based companies like YS Group. Any such action, once taken by the PRC government, could significantly limit or completely hinder the YS Biopharma's ability to offer or continue to offer securities to investors and cause the value of such securities to significantly decline or in extreme cases, become worthless.
- The M&A Rules purport to require offshore special purpose vehicles that are controlled by PRC companies or individuals and that have been formed for the purpose of seeking a public listing on an overseas stock exchange through acquisitions of PRC domestic companies or assets to obtain CSRC approval prior to publicly listing their securities on an overseas stock exchange. The interpretation and application of the M&A Rules remain unclear. YS Biopharma's PRC legal advisor, Jingtian & Gongcheng, has advised that, based on its understanding of the M&A Rules, YS Biopharma will not be required to submit an application to the CSRC for its approval of this Business Combination. Neither YS Biopharma nor any of its subsidiaries has obtained the approval or clearance from the CSRC for this Business Combination, and YS Biopharma does not intend to obtain the approval or clearance from any of such or other regulators in China in connection with this Business Combination unless it is required by CSRC to do so. There is no assurance, however, that regulators in China will not subsequently require YS Biopharma to undergo the approval or clearance procedures and subject YS Biopharma to penalties for non-compliance. See the section entitled "Risk Factors — Risks Related to Doing Business in China — Recent regulatory development in China may exert more oversight and control over listing and offerings that are conducted overseas such as the Business Combination. The approval and/or other requirements of PRC governmental authorities may be required in connection with the Business Combination or YS Biopharma's future issuance of securities to foreign investors under PRC laws, regulations or policies."

For additional detail on these and other risks, see the section entitled "Risk Factors — Risks Related to Doing Business in China" beginning on page 100 of this proxy statement/prospectus.

***Risks Related to Ownership of the YS Biopharma Ordinary Shares (page 117)***

In addition to the risks described above, holders of YS Biopharma Ordinary Shares are also subject to general risks relating to such shares, including, but not limited to, the following:

- A market for YS Biopharma’s securities may not develop or be sustained, which would adversely affect the liquidity and price of its securities.
- YS Biopharma will be an emerging growth company and may take advantage of certain reduced reporting requirements.
- YS Biopharma will be a foreign private issuer within the meaning of the rules under the Exchange Act, and as such YS Biopharma will be exempt from certain provisions applicable to U.S. domestic public companies.
- If YS Group fails to remediate its material weakness and implement and maintain an effective system of internal control over financial reporting, YS Group may be unable to accurately report its results of operations, meet its reporting obligations or prevent fraud.

For additional details on these and other risks, see the section entitled “Risk Factors — Risks Related to Ownership of the YS Biopharma Ordinary Shares” beginning on page 117 of this proxy statement/prospectus.

***Risks Related to Summit and the Business Combination (page 125)***

Furthermore, the process of taking a company public by means of a business combination with a special purpose acquisition company is different from taking a company public through a traditional initial public offering and may create risks for Summit’s unaffiliated investors. These risks include, but are not limited to:

- The process of taking a company public by means of a business combination with a special purpose acquisition company is different from taking a company public through a traditional initial public offering and may create risks for our unaffiliated investors.
- Summit’s current directors and officers and their affiliates have interests that are different from, or in addition to (and which may conflict with), the interests of its shareholders, and therefore potential conflicts of interest exist in recommending that shareholders vote in favor of approval of the Business Combination. Such conflicts of interests include that the Sponsor as well as Summit’s directors and officers are expected to lose their entire investment in Summit if the Business Combination is not completed.
- The exercise of Summit’s directors’ discretion in agreeing to changes or waivers in the terms of the Business Combination may result in a conflict of interest when determining whether such changes to the terms of the Business Combination or waivers of conditions are appropriate and in Summit’s best interest.
- If the Mergers do not qualify as a “Reorganization” within the meaning of Section 368(a) of the Code, then the Mergers generally will be taxable to U.S. Holders.

For additional details on these and other risks, see the section entitled “Risk Factors — Risks Related to Summit and the Business Combination” beginning on page 125 of this proxy statement/prospectus.

**Holding Company Structure**

YS Biopharma is a holding company with no business operations of its own. YS Biopharma conducts a substantial portion of its business and operations through its PRC subsidiaries, in particular, Liaoning Yisheng and Beijing Yisheng, and a substantial portion of its assets are located in China. As a result, its ability to pay dividends and to service any debt it may incur overseas largely depends upon dividends paid by its subsidiaries. If its subsidiaries incur debt on their own behalf in the future, the instruments governing their debt may restrict their ability to pay dividends to YS Biopharma.

In addition, YS Biopharma’s subsidiaries in China are permitted to pay dividends their shareholder only out of their after-tax profit, if any, as determined in accordance with the Accounting Standards for Business Enterprise as promulgated by the Ministry of Finance of the PRC (the “PRC GAAP”). The aggregate Accumulated Deficit for its PRC subsidiaries as determined under the Accounting Standards for Business Enterprise were RMB553.0 million, RMB582.0 million (\$91.7 million) and RMB509.2 million (\$71.7 million) as of March 31, 2021 and 2022 and September 30, 2022, respectively. In addition, pursuant to the relevant PRC laws, enterprises in the PRC have to make appropriation from their after-tax profit, as determined under PRC GAAP, to statutory common reserve funds. The appropriation to the statutory common reserve fund must be at least 10% of the after-tax profits calculated in accordance with PRC GAAP. Appropriation is not required if the reserve fund has reached 50% of the registered capital of such PRC enterprise. See the section

entitled “YS Biopharma’s Business —Regulation” for a detailed discussion of the PRC legal restrictions on dividends and its ability to transfer cash within its group. In addition, holders of YS Biopharma’s securities may potentially be subject to PRC taxes on dividends paid by it in the event YS Biopharma is deemed as a PRC resident enterprise for PRC tax purposes. See the section entitled “Material Taxation Consideration — Material PRC Tax Considerations” for more details.

None of YS Biopharma’s PRC subsidiaries have issued any dividends or distributions to respective holding companies, including YS Biopharma, or any investors as of the date of this prospectus. YS Biopharma’s subsidiaries in the PRC generate and retain cash generated from operating activities and re-invest it in its business. Historically, YS Biopharma has also received equity financing from its shareholders to fund business operations of YS Biopharma’s PRC subsidiaries. In the fiscal years ended March 31, 2021 and 2022, YS Biopharma transferred cash proceeds to Liaoning Yisheng in the amount of RMB428.5 million and RMB291.1 million(\$45.1 million). In the six months ended September 30 of 2021 and 2022, YS Biopharma transferred cash proceeds to Liaoning Yisheng in the amount of RMB291.1 million and nil, respectively. In the future, cash proceeds raised from overseas financing activities may be transferred by YS Biopharma through its subsidiaries outside China to its PRC subsidiaries via capital contribution and shareholder loans, as the case may be. Its PRC subsidiaries will pay dividends to their offshore shareholder to meet the capital needs of YS Biopharma’s business operations out of the PRC. For details about the applicable PRC regulations and rules relating to such cash transfers through YS Group and the associated risks, see the section entitled “Risk Factors — Risks Related to Doing Business in China.”

Cash is transferred among YS Biopharma, its offshore subsidiaries and its PRC subsidiaries, in the following manner: (i) funds are transferred to its PRC subsidiaries from YS Biopharma as needed through YS Biopharma’s subsidiaries outside China in the form of capital contributions or shareholder loans, as the case may be; and (ii) dividends or other distributions may be paid by its PRC subsidiaries to the Company through its subsidiaries outside China. Its subsidiaries in the PRC generate and retain cash generated from operating activities and re-invest it in its business. None of its subsidiaries outside China has made distribution to certain shareholders. In the future, YS Biopharma’s ability to pay dividends, if any, to its shareholders and warrant holders and to service any debt it may incur will depend upon dividends paid by its subsidiaries. In the fiscal year ended March 31, 2021 and 2022 and the six months ended September 30, 2022, YS Group did not transfer any cash proceeds to any of its PRC subsidiaries except for the cash transfers within its Group in connection with the paid-in capital in its PRC subsidiaries. \$59,900,000 of the registered capital was paid up by HK Yisheng to Liaoning Yisheng during the fiscal year ended March 31, 2021 and \$45,099,071.49 of the registered capital was paid up by HK Yisheng to Liaoning Yisheng during the fiscal year ended March 31, 2022. In the six months ended September 30, 2022, no registered capital was paid up by HK Yisheng to Liaoning Yisheng.

#### **Emerging Growth Company**

Upon consummation of the Business Combination, YS Biopharma will be an “emerging growth company” as defined in the JOBS Act. YS Biopharma will remain an “emerging growth company” until the earliest to occur of (i) the last day of the fiscal year (a) following the fifth anniversary of the closing of the Business Combination, (b) in which YS Biopharma has total annual gross revenue of at least \$1.235 billion or (c) in which YS Biopharma is deemed to be a large accelerated filer, which means the market value of the shares of YS Biopharma held by non-affiliates exceeds \$700 million as of the last business day of YS Biopharma’s prior second fiscal quarter, YS Biopharma has been subject to Exchange Act reporting requirements for at least 12 calendar months; and filed at least one annual report, and (ii) the date on which YS Biopharma issued more than \$1.0 billion in non-convertible debt during the prior three-year period. YS Biopharma intends to take advantage of exemptions from various reporting requirements that are applicable to most other public companies, whether or not they are classified as “emerging growth companies,” including, but not limited to, an exemption from the provisions of Section 404(b) of the Sarbanes-Oxley Act requiring that YS Biopharma’s independent registered public accounting firm provide an attestation report on the effectiveness of its internal control over financial reporting and reduced disclosure obligations regarding executive compensation.

In addition, YS Biopharma has elected not to opt out of such extended transition period, which means that when a standard is issued or revised and it has different application dates for public or private companies, YS Biopharma, as an emerging growth company, can adopt the new or revised standard at the time private

companies adopt the new or revised standard. This may make comparison of YS Biopharma's financial statements with certain other public companies difficult or impossible because of the potential differences in accounting standards used.

YS Biopharma will remain an "emerging growth company" until the earliest to occur of (i) the last day of the fiscal year (a) following the fifth anniversary of the closing of the Business Combination, (b) in which YS Biopharma has total annual gross revenue of at least \$1.235 billion or (c) in which YS Biopharma is deemed to be a large accelerated filer, which means the market value of the shares of YS Biopharma held by non-affiliates exceeds \$700 million as of the last business day of YS Biopharma's prior second fiscal quarter, YS Biopharma has been subject to Exchange Act reporting requirements for at least 12 calendar months; and filed at least one annual report, and (ii) the date on which YS Biopharma issued more than \$1.0 billion in non-convertible debt during the prior three-year period.

#### **Foreign Private Issuer**

YS Biopharma is a foreign private issuer within the meaning of the rules under the Exchange Act and, as such, YS Biopharma is permitted to follow the corporate governance practices of its home country, the Cayman Islands, in lieu of the corporate governance standards of Nasdaq Stock Market LLC ("Nasdaq") applicable to U.S. domestic companies. For example, YS Biopharma is not required to have a majority of the board consisting of independent directors nor have a compensation committee or a nominating and corporate governance committee consisting entirely of independent directors. YS Biopharma intends to follow its home country's corporate governance practices as long as it remains a foreign private issuer. As a result, YS Biopharma's shareholders may not have the same protection afforded to shareholders of U.S. domestic companies that are subject to Nasdaq corporate governance requirements. As a foreign private issuer, YS Biopharma is also subject to reduced disclosure requirements and are exempt from certain provisions of the U.S. securities rules and regulations applicable to U.S. domestic issuers such as the rules regulating solicitation of proxies and certain insider reporting and short-swing profit rules.

#### **Potential Controlled Company**

Upon the consummation of the business combination, YS Biopharma may be a "controlled company" within the meaning of the Nasdaq corporate governance rules because it is expected that Mr. Yi Zhang will beneficially control more than 50% of the total voting power of all issued and outstanding YS Biopharma Ordinary Shares through the acting-in-concert arrangement under the Concert Party Agreement immediately following the consummation of the Business Combination, if 75% or more of the Summit Public Shareholders will redeem their Summit Public Shares. See the section entitled "Certain Relationships and Related Person Transactions — YS Group and YS Biopharma Relationships and Related Party Transactions — Concert Party Agreement" for details. As a result, Mr. Yi Zhang will have the ability to exercise significant influence over matters requiring approval by shareholders such as election of directors and other significant corporate actions. Under the Nasdaq corporate governance rules, YS Biopharma may elect not to comply with certain corporate governance rules, including the requirements (1) that a majority of the YS Biopharma's board of directors must consist of independent directors, (2) YS Biopharma's director nominees must be selected or recommended to the board of directors solely by independent directors or by a nominations committee that is comprised entirely of independent directors and (3) that the YS Biopharma Board must have a compensation committee that is comprised entirely of independent directors. YS Biopharma does not currently plan to utilize the exemptions available for controlled companies after the completion of the Business Combination, but instead, it intends to rely on the exemption available for foreign private issuers to follow its home country governance practices. As a result, you will not have the same protection afforded to shareholders of companies that are subject to these corporate governance requirements. For details, see the sections entitled "Risk Factor — Risks Related to Ownership of the YS Biopharma Ordinary Shares — As an exempted company incorporated in the Cayman Islands, YS Biopharma is permitted to adopt certain home country practices in relation to corporate governance matters that differ significantly from Nasdaq's corporate governance requirements; these practices may afford less protection to shareholders. If YS Biopharma opts to rely on such exemptions in the future, such decision might afford less protection to holders of YS Biopharma's ordinary shares" and "Risk Factor — Risks Related to Ownership of the YS Biopharma Ordinary Shares — The post-combination company may be a 'controlled company' within the meaning of the Nasdaq Stock Market listing rules and, as a result, may rely on exemptions from certain corporate governance requirements that provide protection to shareholders of other companies."



### SELECTED HISTORICAL FINANCIAL DATA OF SUMMIT

The following tables present the selected historical financial information derived from Summit's audited financial statements as of December 31, 2021 and for the year ended December 31, 2021 and the period from December 22, 2020 (inception) through December 31, 2020 as well as the unaudited condensed financial statements as of September 30, 2022 and for the nine months ended September 30, 2022, which are included elsewhere in this proxy statement/prospectus.

The financial data set forth below should be read in conjunction with, and is qualified by reference to, "Summit's Management's Discussion and Analysis of Financial Condition and Results of Operations" and the financial statements and notes thereto included elsewhere in this proxy statement/prospectus. Summit's financial statements are prepared and presented in accordance with U.S. GAAP.

	For the Nine Months ended September 30, 2022	For the Nine Months ended September 30, 2021	Year Ended December 31, 2021	For the period from December 22, 2020 (Inception) through December 31, 2020
	(Unaudited)			
<b>Income Statement Data:</b>				
Loss from operations	\$ (1,225,560)	\$ (246,868)	\$ (549,179)	\$ (3,636)
Other income (expense)	15,777,528	(3,399,399)	3,452	—
Net income (loss)	<u>\$14,551,968</u>	<u>\$ (3,646,267)</u>	<u>\$ (545,727)</u>	<u>\$ (3,636)</u>
Basic and diluted weighted average shares outstanding, Class A ordinary shares	<u>20,000,000</u>	<u>8,205,128</u>	<u>11,178,082</u>	<u>—</u>
Basic and diluted net income (loss) per share, Class A ordinary shares subject to possible redemption	<u>\$ 0.57</u>	<u>\$ (0.26)</u>	<u>\$ (0.03)</u>	<u>\$ —</u>
Basic and diluted weighted average shares outstanding, Class B ordinary shares	<u>5,750,000</u>	<u>5,750,000</u>	<u>5,750,000</u>	<u>5,750,000</u>
Basic and diluted net income (loss) per share, Class B ordinary shares	<u>\$ 0.57</u>	<u>\$ (0.26)</u>	<u>\$ (0.03)</u>	<u>\$ (0.00)</u>
<b>Cash Flows Data:</b>				
Net cash (used in) provided by operating activities	<u>\$ (815,101)</u>	<u>\$ (423,286)</u>	<u>\$ (613,225)</u>	<u>\$ —</u>
Net cash used in investing activities	<u>—</u>	<u>\$ (200,000,000)</u>	<u>(200,000,000)</u>	<u>\$ —</u>
Net cash provided by financing activities	<u>—</u>	<u>\$ 201,498,423</u>	<u>201,498,423</u>	<u>\$ —</u>
			As of September 30, 2022	As of December 31, 2021
			(Unaudited)	
<b>Balance Sheet Data:</b>				
Cash			\$ 70,097	\$ 885,198
Other current assets			218,545	141,677
Investments held in Trust Account			201,200,243	200,007,275
Total assets			<u>\$201,488,885</u>	<u>\$201,034,150</u>
Total liabilities			<u>\$ 6,254,766</u>	<u>\$ 20,352,001</u>
Class A ordinary shares subject to possible redemption			<u>201,200,243</u>	<u>200,000,000</u>
Total shareholders' deficit			<u>\$ (5,966,124)</u>	<u>\$ (19,317,851)</u>

## SELECTED HISTORICAL FINANCIAL DATA OF YS BIOPHARMA

The following tables present the selected consolidated financial and other data of YS Biopharma and its subsidiaries.

The financial data set forth below should be read in conjunction with, and is qualified by reference to, “YS Biopharma’s Management’s Discussion and Analysis of Financial Condition and Results of Operations” and the consolidated financial statements and notes thereto included elsewhere in this proxy statement/prospectus. YS Biopharma’s consolidated financial statements are prepared and presented in accordance with U.S. GAAP. The historical results included below and elsewhere in this proxy statement/prospectus are not indicative of the future performance of YS Biopharma following the Business Combination. You should read the following information in conjunction with those financial statements and accompanying notes included elsewhere in this prospectus and “YS Biopharma’s Management’s Discussion and Analysis of Financial Condition and Results of Operations.”

The selected consolidated statements of operations and other comprehensive loss data for the fiscal years ended March 31, 2021 and 2022 and consolidated statements of financial position data as of March 31, 2021 and 2022 have been derived from the audited consolidated balance sheet of YS Biopharma and its subsidiaries as of March 31, 2021 and 2022, and the related consolidated statements of operations and other comprehensive loss for each of the fiscal years in the two-year period ended March 31, 2022 included elsewhere in this proxy statement/prospectus.

The selected consolidated statements of operations and other comprehensive loss data for the six months ended September 30, 2022 and consolidated statements of financial position data as of September 30, 2022 have been derived from the unaudited consolidated balance sheet of YS Biopharma and its subsidiaries as of September 30, 2022, and the related consolidated statements of operations and other comprehensive loss for the six months ended September 30, 2022, also included elsewhere in this proxy statement/prospectus.

### Summary statements of operations and comprehensive loss:

	For the Six Months Ended September 30,			For the Fiscal Years Ended March 31,		
	2021	2022	2022	2021	2022	2022
	(RMB)	(RMB)	(\$)	(RMB)	(RMB)	(\$)
	(Unaudited)	(Unaudited)	(Unaudited)			
<b>Revenues</b>	<b>269,433,426</b>	<b>399,534,723</b>	<b>\$56,274,081</b>	<b>257,015,929</b>	<b>502,949,894</b>	<b>\$ 79,227,166</b>
Cost of revenues	63,599,621	93,700,779	13,197,665	59,656,877	117,066,090	18,440,832
<b>Gross profit</b>	<b>205,833,805</b>	<b>305,833,944</b>	<b>43,076,416</b>	<b>197,359,052</b>	<b>385,883,804</b>	<b>60,786,334</b>
<b>Operating expenses:</b>						
Selling	86,265,281	150,228,079	21,159,480	73,485,259	185,999,704	29,299,597
General and administrative	51,664,591	49,587,013	6,984,283	155,334,386	107,620,500	16,952,916
Research and development	124,051,209	123,861,107	17,445,718	94,387,144	211,222,263	33,272,780
<b>Total operating expenses</b>	<b>261,981,081</b>	<b>323,676,199</b>	<b>45,589,481</b>	<b>323,206,789</b>	<b>504,842,467</b>	<b>79,525,293</b>
<b>Loss from operations</b>	<b>(56,147,276)</b>	<b>(17,842,255)</b>	<b>(2,513,065)</b>	<b>(125,847,737)</b>	<b>(118,958,663)</b>	<b>(18,738,959)</b>
<b>Other income (expenses):</b>						
Late fees related to income tax	(112,420)	—	—	(11,464,741)	—	—
Late fees related to taxes other than income tax	(1,396,221)	(299,417)	(42,173)	(7,261,947)	(231,231)	(36,425)
Late fees related to social security insurance	—	—	—	(7,701,793)	(1,852,378)	(291,796)
Government grants	19,600,822	22,456,691	3,163,003	3,530,405	23,020,413	3,626,290
Financial expenses, net	(352,694)	(14,949,434)	(2,105,613)	(29,689,927)	(2,717,433)	(428,064)
Other income (expenses), net	(993,957)	74,675	10,518	4,063,743	(327,987)	(51,666)
<b>Total other (expenses) income, net</b>	<b>16,745,530</b>	<b>7,282,515</b>	<b>1,025,735</b>	<b>(48,524,260)</b>	<b>17,891,384</b>	<b>2,818,339</b>

	For the Six Months Ended September 30,			For the Fiscal Years Ended March 31,		
	2021	2022	2022	2021	2022	2022
	(RMB)	(RMB)	(\$)	(RMB)	(RMB)	(\$)
	(Unaudited)	(Unaudited)	(Unaudited)			
<b>Loss before income taxes</b>	<b>(39,401,746)</b>	<b>(10,559,740)</b>	<b>(1,487,330)</b>	<b>(174,371,997)</b>	<b>(101,067,279)</b>	<b>(15,920,620)</b>
<b>Income tax expense</b>	<b>(5,689,586)</b>	<b>(565,625)</b>	<b>(79,668)</b>	<b>(17,454,245)</b>	<b>(4,937,122)</b>	<b>(777,720)</b>
<b>Net loss</b>	<b>(45,091,332)</b>	<b>(11,125,365)</b>	<b>(1,566,998)</b>	<b>(191,826,242)</b>	<b>(106,004,401)</b>	<b>(16,698,340)</b>
Accretion to redemption value of convertible redeemable preferred shares	(65,013,751)	(72,083,238)	(10,152,855)	(16,610,297)	(130,662,326)	(20,582,579)
<b>Net loss attributable to YS Biopharma Co. Ltd</b>	<b>(110,105,083)</b>	<b>(83,208,603)</b>	<b>\$(11,719,853)</b>	<b>(208,436,539)</b>	<b>(236,666,727)</b>	<b>\$(37,280,919)</b>
<b>Net loss</b>	<b>(45,091,332)</b>	<b>(11,125,365)</b>	<b>\$(1,566,998)</b>	<b>(191,826,242)</b>	<b>(106,004,401)</b>	<b>\$(16,698,340)</b>
Other comprehensive income: foreign currency translation gain	11,321,167	(168,653,952)	(23,754,747)	22,455,217	38,864,606	6,122,146
<b>Total comprehensive loss</b>	<b>(33,770,165)</b>	<b>(179,779,317)</b>	<b>\$(25,321,745)</b>	<b>(169,371,025)</b>	<b>(67,139,795)</b>	<b>\$(10,576,194)</b>
<b>Loss per share*:</b>						
– Basic and Diluted	(0.18)	(0.05)	\$(0.01)	(0.78)	(0.43)	\$(0.07)
<b>Weighted average number of ordinary shares outstanding*:</b>						
– Basic and Diluted	247,311,533	247,141,861	247,141,861	247,311,533	247,311,533	247,311,533

\* Gives retroactive effect to reflect the reorganization in February 2021.

#### Summary balance sheets:

	As of September 30,		As of March 31,		
	2022	2022	2021	2022	2022
	(RMB)	(\$)	(RMB)	(RMB)	(\$)
	(Unaudited)	(Unaudited)			
<b>ASSETS</b>					
Current assets	871,552,683	122,757,357	733,204,286	764,764,393	120,469,486
Total non-current assets	676,885,437	95,338,663	433,970,786	676,988,748	106,642,631
<b>Total assets</b>	<b>1,548,438,120</b>	<b>\$ 218,096,020</b>	<b>1,167,175,072</b>	<b>1,441,753,141</b>	<b>\$ 227,112,117</b>
<b>LIABILITIES, MEZZANINE EQUITY AND SHAREHOLDERS' DEFICIT</b>					
Current liabilities	575,338,836	81,035,921	345,040,994	475,914,160	74,968,363
Non-current liabilities	315,222,809	44,398,829	45,538,214	294,586,777	46,404,772
<b>Total liabilities</b>	<b>890,561,645</b>	<b>125,434,750</b>	<b>390,579,208</b>	<b>770,500,937</b>	<b>121,373,135</b>
<b>Mezzanine equity</b>	<b>1,608,561,727</b>	<b>226,564,371</b>	<b>1,285,458,571</b>	<b>1,370,221,392</b>	<b>215,844,081</b>
<b>Shareholders' deficit</b>	<b>(950,685,252)</b>	<b>(133,903,101)</b>	<b>(508,862,707)</b>	<b>(698,969,188)</b>	<b>(110,105,099)</b>
<b>Total liabilities, mezzanine equity and shareholders' deficit</b>	<b>1,548,438,120</b>	<b>\$ 218,096,020</b>	<b>1,167,175,072</b>	<b>1,441,753,141</b>	<b>\$ 227,112,117</b>

**Summary statements of cash flows**

	For the Six Months Ended September 30,			For the Fiscal Years Ended March 31,		
	2021	2022	2022	2021	2022	2022
	(RMB)	(RMB)	(\$)	(RMB)	(RMB)	(\$)
	(Unaudited)	(Unaudited)	(Unaudited)			
Net cash used in operating activities	(176,984,374)	(107,395,153)	(15,126,504)	(246,610,437)	(173,545,357)	(27,337,727)
Net cash used in investing activities	(203,390,377)	(19,024,351)	(2,679,561)	(104,238,941)	(298,923,958)	(47,087,987)
Net cash provided by financing activities	43,885,865	51,907,325	7,311,097	739,258,696	364,558,145	57,427,010
Effect of foreign exchange rate on cash	(4,446,301)	30,471,942	4,291,943	(2,674)	(11,478,411)	(1,808,136)
<b>Net increase (decrease) in cash</b>	<b>(340,935,187)</b>	<b>(44,040,237)</b>	<b>(6,203,025)</b>	<b>388,406,644</b>	<b>(119,389,581)</b>	<b>(18,806,840)</b>
Cash at the beginning of the fiscal year	390,457,084	271,067,503	38,179,597	2,050,440	390,457,084	61,506,740
Cash at the end of the fiscal year	49,521,897	227,027,266	\$ 31,976,572	390,457,084	271,067,503	\$ 42,699,900

### SUMMARY UNAUDITED PRO FORMA CONDENSED COMBINED FINANCIAL INFORMATION

The following summary unaudited pro forma condensed combined financial data (the “Summary Pro Forma Information”) gives effect to the transactions contemplated by the Business Combination Agreement (the “Business Combination”). The Business Combination will be accounted as recapitalization. Under this method of accounting, Summit will be treated as the “acquired” company for financial reporting purposes.

The summary unaudited pro forma condensed combined balance sheet as of September 30, 2022, giving effect to the Business Combination as if it had been consummated on that date. The summary unaudited pro forma condensed combined statement of operations for the six months ended September 30, 2022 and for the fiscal year ended March 31, 2022 has given effect to the Business Combination as if it had occurred on April 1, 2021.

The Summary Pro Forma Information has been derived from, and should be read in conjunction with, the more detailed unaudited pro forma condensed combined financial information included in the section entitled “Unaudited Pro Forma Condensed Combined Financial Information” in this proxy statement/prospectus and the accompanying notes thereto. The unaudited pro forma condensed combined financial information is based upon, and should be read in conjunction with, the historical financial statements and related notes of Summit and YS Biopharma for the applicable periods included in this proxy statement/prospectus. The Summary Pro Forma Information has been presented for informational purposes only and is not necessarily indicative of what YS Biopharma’s financial position or results of operations actually would have been had the Business Combination been completed as of the dates indicated. In addition, the Summary Pro Forma Information does not purport to project the future financial position or operating results of YS Biopharma following the Business Combination.

The unaudited pro forma condensed combined financial information has been prepared using the assumptions below:

- **Assuming No Redemptions:** This presentation assumes that no Summit Public Shareholders elect to have their Summit Public Shares redeemed for cash in connection with the Business Combination as permitted by the Summit Articles and there are no Dissenting Summit Shares.
- **Assuming 100% Redemptions:** This presentation assumes that 20,000,000 Summit Public Shares are redeemed for aggregate redemption payments of \$201,200,243, assuming a \$10.06 per share Redemption Price and based on funds in the trust account as of September 30, 2022. The Business Combination Agreement includes a closing condition, which requires that the Available Closing Cash Amount shall be no less than \$30,000,000. The Available Closing Cash Amount is calculated as the sum of: (i) the amount of cash proceeds from the Trust Account, plus (ii) the aggregate amount of cash that has been funded to, or that will be funded immediately prior to or concurrently with the Closing to Summit pursuant to the Forward Purchase Agreements, plus (iii) any amount raised pursuant to permitted equity financings prior to the Closing (excluding any proceeds that will be invested by existing shareholders or creditors of YS Biopharma immediately prior to the First Merger Effective Time), minus (iv) the aggregate amount payable to Summit Public Shareholders exercising their redemption rights. Accordingly, if no more than 85% of the total Summit Public Shares are redeemed, the Available Closing Cash Amount will be no less than \$30,000,000, even if Summit and YS Biopharma do not receive any proceeds pursuant to the Forward Purchase Agreements or raise any other permitted equity financings prior to the Closing. However, even if the actual redemption percentage is higher than 85%, the Business Combination may still be consummated if (i) YS Biopharma waives the Available Closing Cash Amount as a closing condition, or (ii) the post redemption cash proceeds in the Trust Account, when combined with proceeds received under the Forward Purchase Agreements and/or other permitted equity financings prior to the Closing, are no less than \$30,000,000.

	Pro Forma Combined			
	Assuming No Redemptions	Assuming No Redemptions	Assuming 100% Redemptions	Assuming 100% Redemptions
	(RMB)	(\$)	(RMB)	(\$)
<b>Summary Unaudited Pro Forma Condensed Combined Statement of Profit or Loss Data for the Six Months Ended September 30, 2022</b>				
Profit for the period	27,358,113	\$ 3,853,364	27,358,113	\$ 3,853,364
Basic and diluted net earnings per share, YishengBio ordinary shares	0.24	\$ 0.03	0.30	\$ 0.04
Basic and diluted weighted average shares outstanding, YishengBio ordinary shares	113,460,795	113,460,795	92,174,995	92,174,995
<b>Summary Unaudited Pro Forma Condensed Combined Statement of Profit or Loss Data For the Fiscal Year Ended March 31, 2022</b>				
Loss for the period	(104,998,214)	\$ (16,539,841)	(104,998,214)	\$ (16,539,841)
Basic and diluted net loss per share, YS Biopharma ordinary shares	(0.93)	\$ (0.15)	(1.14)	\$ (0.18)
Basic and diluted weighted average shares outstanding, YS Biopharma ordinary shares	113,460,795	113,460,795	92,174,995	92,174,995
<b>Summary Unaudited Pro Forma Condensed Combined Balance Sheet Data as of September 30, 2022</b>				
Total assets	3,158,872,521	\$444,924,156	1,730,391,036	\$243,723,913
Total liabilities	924,319,533	\$130,189,516	924,319,533	\$130,189,516
Total equity	2,234,552,988	\$314,734,640	806,071,503	\$113,534,397

### COMPARATIVE PER SHARE INFORMATION

The following table sets forth summary historical comparative share information for Summit and YS Biopharma and unaudited pro forma condensed combined per share information of the combined company after giving effect to the Business Combination, assuming two redemption scenarios as follows:

- **Assuming No Redemptions:** This presentation assumes that no Summit Public Shareholders elect to have their Summit Public Shares redeemed for cash in connection with the Business Combination as permitted by the Summit Articles and there are no Dissenting Summit Shares.
- **Assuming Maximum Redemptions:** This presentation assumes that 20,000,000 Summit Public Shares are redeemed for aggregate redemption payments of \$201,200,243, assuming a \$10.06 per share Redemption Price and based on funds in the trust account as of September 30, 2022. The Business Combination Agreement includes a closing condition, which requires that the Available Closing Cash Amount shall be no less than \$30,000,000. The Available Closing Cash Amount is calculated as the sum of: (i) the amount of cash proceeds from the Trust Account, plus (ii) the aggregate amount of cash that has been funded to, or that will be funded immediately prior to or concurrently with the Closing to Summit pursuant to the Forward Purchase Agreements, plus (iii) any amount raised pursuant to permitted equity financings prior to the Closing (excluding any proceeds that will be invested by existing shareholders or creditors of YS Biopharma immediately prior to the First Merger Effective Time), minus (iv) the aggregate amount payable to Summit Public Shareholders exercising their redemption rights. Accordingly, if no more than 85% of the total Summit Public Shares are redeemed, the Available Closing Cash Amount will be no less than \$30,000,000, even if Summit and YS Biopharma do not receive any proceeds pursuant to the Forward Purchase Agreements or raise any other permitted equity financings prior to the Closing. However, even if the actual redemption percentage is higher than 85%, the Business Combination may still be consummated if (i) YS Biopharma waives the Available Closing Cash Amount as a closing condition, or (ii) the post redemption cash proceeds in the Trust Account, when combined with proceeds received under the Forward Purchase Agreements and/or other permitted equity financings prior to the Closing, is no less than \$30,000,000.

If the actual facts differ from these assumptions, these numbers will be different.

The unaudited pro forma book value information as of September 30, 2022 and as of March 31, 2022 gives effect to the Business Combination as if it had occurred on September 30, 2022 and March 31, 2022. The net earnings(loss) per share and weighted average shares outstanding information reflect the Business Combination as if it had occurred on April 1, 2021.

This information is only a summary and should be read together with the summary historical financial information included elsewhere in this proxy statement/prospectus, and the historical financial statements of Summit and YS Biopharma and related notes that are included elsewhere in this proxy statement/prospectus.

The unaudited pro forma combined per share information of Summit and YS Biopharma is derived from, and should be read in conjunction with, the unaudited pro forma condensed combined financial statements and related notes included elsewhere in this proxy statement/consent solicitation statement/prospectus. The adjustments presented in the unaudited pro forma combined financial information have been identified and presented to provide relevant information necessary for an understanding of the combined company after giving effect to the Business Combination.

The unaudited pro forma combined share information below does not purport to represent what the actual results of operations or the net income per share would have been had the companies been combined during the periods presented, nor earnings per share for any future date or period. The unaudited pro forma combined book value per share information below does not purport to represent what the value of YS Biopharma would have been had the companies been combined during the periods indicated.

	Historical			Pro Forma Combined <sup>(7)</sup>	
	Summit		YS Biopharma	Assuming No Redemption	Assuming 100% Redemption
	Class A Shares	Class B Shares	Ordinary Shares	Ordinary Shares	Ordinary Shares
<b>As of and For the Six Months Ended September 30, 2022</b>					
Book value per share (in RMB) <sup>(1)(2)(3)</sup>	N/A	(7.37)	(2.85)	19.69	8.74
Book value per share (in \$)	N/A	\$ (1.04)	\$ (0.40)	\$ 2.77	\$ 1.23
Net earnings (loss) per share-basic and diluted (in RMB)	1.94	1.94	(0.03)	0.24	0.30
Net earnings (loss) per share-basic and diluted (in \$)	\$ 0.27	\$ 0.27	\$ (0.01)	\$ 0.03	\$ 0.04
YS Biopharma Shareholders	—	—	—	83,424,995	83,424,995
Summit Public Shareholders <sup>(6)</sup>	—	—	—	22,337,818	—
Sponsor and certain Summit directors <sup>(4)(5)</sup>	—	—	—	3,928,475	3,928,475
Forward Purchase Investors <sup>(4)</sup>	—	—	—	3,769,507	4,821,525
Weighted average shares outstanding – basic and diluted	20,000,000	5,750,000	333,699,980	113,460,795 <sup>(8)</sup>	92,174,995 <sup>(8)</sup>
<b>As of and For the Fiscal Year Ended March 31, 2022</b>					
Book value per share (in RMB) <sup>(1)(2)(3)</sup>	N/A	(21.33)	(2.09)	17.87	8.22
Book value per share (in \$)	N/A	\$ (3.36)	\$ (0.33)	\$ 2.81	\$ 1.29
Net loss per share-basic and diluted (in RMB)	2.51	2.51	(0.32)	(0.93)	(1.14)
Net loss per share-basic and diluted (in \$)	\$ 0.40	\$ 0.40	\$ (0.05)	\$ (0.15)	\$ (0.18)
YS Biopharma Shareholders	—	—	—	83,424,995	83,424,995
Summit Public Shareholders <sup>(6)</sup>	—	—	—	22,337,818	—
Sponsor and certain Summit directors <sup>(4)(5)</sup>	—	—	—	3,928,475	3,928,475
Forward Purchase Investors <sup>(4)</sup>	—	—	—	3,769,507	4,821,525
Weighted average shares outstanding – basic and diluted	20,000,000	5,750,000	333,699,980	113,460,795 <sup>(8)</sup>	92,174,995 <sup>(8)</sup>

- (1) The historical book value per share for summit is calculated by dividing total shareholders' deficit, excluding shares subject to possible redemption, by the number of non-redeemable Class B ordinary shares outstanding at the end of the period.
- (2) The historical book value per share for YS Biopharma is calculated by dividing total shareholders' deficit, by the number of ordinary shares outstanding at the end of the period.
- (3) The pro forma book value per share for YS Biopharma is calculated by dividing total shareholders' equity by the number of ordinary shares outstanding at the end of the period.
- (4) The share amounts reflect the transfer of 375,000 Founder Shares of Summit from the Sponsor to the Forward Purchase Investors in connection with the Forward Purchase Agreements. The 375,000 outstanding Summit Class B ordinary shares held by the Forward Purchase Investors are exchanged into Summit Class A ordinary shares on a one-for-one basis. In addition, on April 30, 2021, the Company entered into forward purchase agreements with the Sponsor, Snow Lake Capital (HK) Limited and Valliance Fund, pursuant to which the Forward Purchase Investors agreed to subscribe for an aggregate of 3,000,000 Summit Class A ordinary shares. Assuming the Forward Purchase Investors fully pay their purchase price in accordance with the forward purchase agreements, each Summit Class A ordinary share held by the Forward Purchase Investors is then converted into such number of YS Biopharma Class A ordinary shares equal to the Class A Exchange Ratio of (i) 1.1169 under a No Redemption Scenario or (ii) 1.4286 under a 100% Redemption Scenario.
- (5) The share amounts reflect the Sponsor will surrender 1,446,525 Summit Class B Ordinary Shares for nil consideration immediately prior to the First Merger Effective Time and exchange all of the remaining Summit Shares held by it into YS Biopharma Ordinary Shares on a one-for-one basis at the First Merger Effective Time.
- (6) Outstanding Summit Class A ordinary shares held by the Summit Public Shareholders are converted into the number of YS Biopharma Class A ordinary shares equal to the Class A Exchange Ratio of (i) 1.1169 under a No Redemption Scenario or (ii) 1.4286 under a 100% Redemption Scenario.
- (7) The public warrants, private placement warrants and shares of YS Biopharma options were excluded from the computation of pro forma net loss per share, basic and diluted, for the fiscal year ended March 31, 2022 and the six months ended September 30, 2022 because their effect would be anti-dilutive. The share amounts do not take into account (i) 10,000,000 shares of public warrants and 6,750,000 shares of private placement warrants that will remain outstanding immediately following the Business Combination and may be exercised thereafter and (ii) 6,656,582 shares of outstanding YS Biopharma options, vested or unvested, that were assumed by YS Biopharma upon the completion of the Business Combination. If the actual facts are different than the assumptions set forth above, the share amounts and percentage ownership numbers set forth above will be different and (iii) 700,000 shares under the Convertible Promissory Note that will remain outstanding immediately following the Business Combination and may be exercised thereafter.
- (8) The share amount includes (i) 83,424,995 shares held by existing YS Biopharma's shareholders and (ii) in the case of no redemption, 30,035,800 shares to be issued to non-redeeming Summit Shareholders and Forward Purchase Investors upon completion of the Business Combination. The share amount does not include 10,000 shares to be issued as part of advisory fees to YS Biopharma's financial advisor.



## FORWARD-LOOKING STATEMENTS

This proxy statement/prospectus includes statements that express Summit's and YS Biopharma's opinions, expectations, beliefs, plans, objectives, assumptions or projections regarding future events or future results of operations or financial condition and therefore are, or may be deemed to be, "forward-looking statements." These forward-looking statements can generally be identified by the use of forward-looking terminology, including the terms "believes," "estimates," "anticipates," "expects," "seeks," "projects," "intends," "plans," "may," "will" or "should" or, in each case, their negative or other variations or comparable terminology. These forward-looking statements include all matters that are not historical facts. They appear in a number of places throughout this proxy statement/prospectus and include statements regarding Summit's and YS Biopharma's intentions, beliefs or current expectations concerning, among other things, the Business Combination, the benefits and synergies of the Business Combination, including anticipated cost savings, results of operations, financial condition, liquidity, prospects, growth, strategies, future market conditions or economic performance and developments in the capital and credit markets and expected future financial performance, the markets in which YS Group operates as well as any information concerning possible or assumed future results of operations of the combined company after the consummation of the Business Combination. Such forward-looking statements are based on available current market material and management's expectations, beliefs and forecasts concerning future events impacting Summit, YS Group and YS Biopharma. Factors that may impact such forward-looking statements include:

- The regulatory environment and changes in laws, regulations or policies in the jurisdictions in which YS Group operates;
- YS Group's ability to successfully compete in highly competitive industries and markets;
- YS Group's ability to continue to adjust its offerings to meet market demand, attract customers to choose its products and services and grow its ecosystem;
- Political instability in the jurisdictions in which YS Group operates;
- The overall economic environment and general market and economic conditions in the jurisdictions in which YS Group operates;
- YS Group's ability to execute its strategies, manage growth and maintain its corporate culture as it grows;
- YS Group's anticipated investments in new products, services, collaboration arrangements, technologies and strategic acquisitions, and the effect of these investments on its results of operations;
- YS Group's ability to develop and protect intellectual property;
- Changes in the need for capital and the availability of financing and capital to fund these needs;
- Anticipated technology trends and developments and YS Group's ability to address those trends and developments with its products and services;
- The safety, affordability, convenience and breadth of YS Group's products and services;
- Man-made or natural disasters, health epidemics, and other outbreaks including war, acts of international or domestic terrorism, civil disturbances, occurrences of catastrophic events and acts of God such as floods, earthquakes, wildfires, typhoons and other adverse weather and natural conditions that affect YS Group's business or assets;
- The loss of key personnel and the inability to replace such personnel on a timely basis or on acceptable terms;
- Exchange rate fluctuations;
- Changes in interest rates or rates of inflation;
- Legal, regulatory and other proceedings;
- The number and percentage of Summit Shareholders voting against the Business Combination Proposal, the Merger Proposal and/or seeking redemption;
- The occurrence of any event, change or other circumstances that could give rise to the termination of the Business Combination Agreement; and

- YS Biopharma’s ability to initially list, and once listed, maintain the listing of its securities on Nasdaq following the Business Combination; and the results of future financing efforts.

The forward-looking statements contained in this proxy statement/prospectus are based on Summit’s and YS Biopharma’s current expectations and beliefs concerning future developments and their potential effects on the Business Combination and YS Biopharma. There can be no assurance that future developments affecting Summit and/or YS Biopharma will be those that Summit or YS Biopharma has anticipated. These forward-looking statements involve a number of risks, uncertainties (some of which are beyond either Summit’s or YS Biopharma’s control) or other assumptions that may cause actual results or performance to be materially different from those expressed or implied by these forward-looking statements. These risks and uncertainties include, but are not limited to, those factors described under the heading “Risk Factors.” Should one or more of these risks or uncertainties materialize, or should any of the assumptions prove incorrect, actual results may vary in material respects from those projected in these forward-looking statements. Summit and YS Biopharma will not undertake any obligation to update or revise any forward-looking statements, whether as a result of new information, future events or otherwise, except as may be required under applicable securities laws.

Before a shareholder grants its proxy, instructs how its vote should be cast or votes on the Business Combination Proposal, the Merger Proposal or the Adjournment Proposal, it should be aware that the occurrence of the events described in the section entitled “Risk Factors” and elsewhere in this proxy statement/prospectus may adversely affect Summit and/or YS Biopharma.

## RISK FACTORS

*You should carefully consider the following risk factors, together with all of the other information included in this proxy statement/prospectus, before you decide whether to vote or instruct your vote to be cast to approve the proposals described in this proxy statement/prospectus. Certain of the following risk factors apply to the business and operations of YS Group and will also apply to the business and operations of YS Group following the completion of the Business Combination. The occurrence of one or more of the events or circumstances described in these risk factors, alone or in combination with other events or circumstances, may adversely affect the ability to complete or realize the anticipated benefits of the Business Combination, and may have a material adverse effect on the business, financial condition, results of operations, prospects and trading price of YS Biopharma following the Business Combination. The risks discussed below may not prove to be exhaustive and are based on certain assumptions made by YS Biopharma, Summit and YS Group, which later may prove to be incorrect or incomplete. YS Biopharma, Summit and YS Group may face additional risks and uncertainties that are not presently known to them, or that are currently deemed immaterial, but which may also ultimately have an adverse effect on any such party.*

### **Risks Related to YS Group's Business and Products**

#### **Risks Related to YS Group's Marketed Product**

***YS Group depends on its current marketed rabies vaccine product to generate substantially all of its revenue in the near term. YS Group's previous operating history of manufacturing and commercializing vaccines may not provide an adequate basis to judge the viability of its business, the effectiveness of its management and its future profitability and prospects in respect of its marketed product.***

YS Group currently owns one marketed product in China, its YSJA™ rabies vaccine, sales of which have generated and are expected to continue to generate substantially all of YS Group's revenue in the near term. In the fiscal years ended March 31, 2021 and 2022 and the six months ended September 30, 2022, revenues from sales of rabies vaccine accounted for approximately 100% of the total revenues of YS Group. Its ability to continuously commercialize YSJA™ rabies vaccine and expand its sales will depend on various factors, including, among other things, its ability to maintain proper manufacturing facilities, achieve effective sales and marketing, maintain competitive attractiveness, secure widespread acceptance of this product, maintain compliance with ongoing regulatory requirement, properly price and obtain coverage and adequate reimbursement of this product by governmental authorities, private health insurers and other third-party payors. If YSJA™ rabies vaccine fails to achieve successful sales and further sales expansion, it could have a material adverse effect on the business, financial condition and results of operations of YS Group.

The vaccine's manufacturing processes, labeling, packaging, distribution, adverse event reporting, storage, advertising, promotion, sampling, recordkeeping, and post-marketing studies for its products are subject to extensive and ongoing regulatory requirements. These requirements include submissions of safety and other post-marketing information and reports, registration, and continued compliance with the Good Manufacturing Practice and the Good Clinical Practice. As of the date of this proxy statement/prospectus, YS Group manufactured YSJA™ rabies vaccine in its GMP-compliant plant in Shenyang, China. If YS Group intends to build up new plants in the future, or if the existing license for current plant is expired or withdrew in the future, YS Group will be required to apply for new license or renew its current license for future production, which may disrupt the production and commercialization plan of YSJA™ rabies vaccine. In addition, each lot release of the rabies vaccine produced by YS Group is also subject to the inspection and pre-approval by relevant regulatory authorities before it enters into the market for sale. Any regulatory approvals that YS Group receives for its products are also subject to certain market limitations, approval conditions or post-market testing requirements. Any government investigation of alleged violations of relevant laws and regulations could generate negative publicity and subject YS Group to additional compliance costs. Moreover, regulatory policies may change or additional government regulations may be enacted that could prevent, limit or delay regulatory approval. If YS Group is not able to maintain regulatory compliance, regulatory approval that has been obtained may be lost and it may not achieve or sustain profitability, which may significantly harm YS Group's business, financial condition, results of operations and prospects.

In addition, YS Group's previous operating history is not indicative of its growth in business and revenue in the future. There may also be a decrease in demand, pricing or supply for its marketed product. Factors that

could lead to such decline include, among others, increased competition, new product introductions, government-imposed pricing constraints, intellectual property issues, disruptions in manufacturing or distribution, and newly discovered safety issues. Any difference between YS Group's expected sales and the actual sales for its marketed product could materially and adversely affect YS Group's business, financial condition, results of operations and prospects.

***YS Group faces substantial competition. Its competitors may discover, develop or commercialize products before, or more successfully than, YS Group do, or develop therapies that are more advanced or effective than ours, which may adversely affect YS Group's financial condition and its ability to successfully market or commercialize its marketed product and product candidates.***

YS Group faces substantial competition with its marketed product, YSJA™ rabies vaccine, and product candidates, including PIKA rabies vaccine. The human rabies vaccine market in China is highly competitive. Moreover, the development and commercialization of new products is also highly competitive. YS Group faces competition with respect to its existing product candidates, and will face competition with respect to any product candidates that YS Group may seek to develop or commercialize in the future, from major pharmaceutical companies, specialty pharmaceutical companies and biotechnology companies worldwide. Competitors of YS Group's product and product candidates include vaccines, cell-based immuno-oncology therapies, checkpoint inhibitors and other immunological biologics. Potential competitors also include academic institutions, government agencies and other public and private research organizations that conduct research, seek patent protection and establish collaborative arrangements for research, development, manufacture and commercialization. Specifically, there are a large number of companies, including many major pharmaceutical and biotechnology companies, that develop or market treatments for infectious diseases and immuno-oncology drugs.

Many of the companies against which YS Group is competing or may compete in the future have significantly greater financial resources and expertise in research and development, manufacture, preclinical testing, conducting clinical trials, obtaining regulatory approvals and marketing approved products than YS Group does. These competitors also compete with YS Group in recruiting and retaining qualified scientific and management personnel and establishing clinical trial sites and patient registration for clinical trials, as well as in acquiring technologies complementary to, or necessary for, YS Group's marketed product and product candidates. New competitors, domestic or foreign, may also enter into the markets in which YS Group currently operates. Accordingly, YS Group may not be able to outperform a competing product for any number of reasons, including:

- the competing product may be, or may be perceived to be, more effective, safer or otherwise superior in quality or brand recognition;
- the competing product was introduced to the market earlier or gained wide market acceptance;
- the competing product incorporates more recent technological innovations or research findings;
- the competitor may have greater access to certain raw materials;
- the competitor may have more efficient manufacturing processes, greater manufacturing capacity or lower manufacturing costs;
- the competitors may develop and commercialize products that are safer, more effective, have fewer or less severe side effects, are more user-friendly or are less expensive;
- the competitors may obtain regulatory approval for their products more rapidly; or
- the competitor may have more aggressive marketing strategies, greater marketing capabilities or pricing flexibility.

The technologies used in YS Group's industry are evolving rapidly, and new developments frequently result in price competition and product obsolescence. Additionally, technologies developed by competitors may render YS Group's marketed product and product candidates uneconomical or obsolete, and YS Group may not be successful in marketing its marketed product and product candidates against competitors. In addition, YS Group may be impacted by competition from substitute products. If YS Group is unable to compete effectively, it may lose market share and its financial performance may deteriorate. The availability of YS Group's

competitors' products could limit the demand, and the price YS Group is able to charge, for any products that YS Group may develop and commercialize.

***YS Group's product candidates, once commercialized, may compete with its existing marketed product.***

YS Group is producing and selling YSJA™ rabies vaccine, which is a conventional rabies vaccine product. YS Group is also developing PIKA rabies vaccine, which is a rabies vaccine featuring accelerated regimen. Given the potential significant advantages of PIKA rabies vaccine over conventional products, YS Group intends to formulate a premium pricing strategy to differentiate it from conventional products, including YSJA™ rabies vaccine. Nevertheless, once PIKA rabies vaccine enters into the market, it may compete with YSJA™ rabies vaccine in, among others, customer acquisition, market position and commercialization resources, which may hinder the sales performance and growth of YSJA™ rabies vaccine. In addition, the growth potential and market position of PIKA rabies vaccines may also be affected by the presence and growth of YSJA™ rabies vaccine. The competition between YS Group's marketed product and any product candidate may also impose a burden on its internal resources, disrupt its cost structure and reduce its operating efficiency. As a result, YS Group's prospects and results of operations may be materially and adversely affected.

***If the rabies vaccine industry in China does not grow as expected or declines, YS Group's ability to expand its business and results of operations could be materially and adversely affected.***

The rabies vaccine industry in China has developed rapidly in the past decade, driven by favorable government policies, GDP growth, increase awareness on public health, affordability of vaccination and the emergence of new virus and pandemics, according to the F&S Report. However, the continued growth of the rabies vaccine industry will depend on numerous factors, many of which are beyond YS Group's control, including but not limited to:

- development, safety and efficacy, availability and affordability of alternative therapeutics;
- perception, recognition and acceptance of vaccines by end-users, CDCs, KOLs and others related to the vaccine or disease prevention industry;
- technological and scientific advancements, as well as manufacturing, storage and transportation techniques related to vaccines;
- general awareness on public health;
- changes in demographic composition and structure;
- changes in government policy and utilization of resources on public health matters;
- the general economic condition in China and globally.

Any decline or slowdown in the growth of the vaccine industry could materially and adversely affect YS Group's ability to expand its business and generate positive operating results.

***The commercial success of any of YS Group's marketed product and product candidates depends on its degree of market acceptance by end-users, CDCs, KOLs and others related to the vaccine or disease prevention industry.***

If end-users, CDCs, KOLs and others related to the vaccine or disease prevention industry do not accept YS Group's marketed product or product candidates, YS Group may be unable to generate significant revenue and may suffer losses. For example, in China, substantially all vaccine products are sold to CDCs, which comprise substantially YS Group's entire customer base for YSJA™ rabies vaccine. YS Group cannot assure that its vaccine or vaccine candidates will gain market acceptance among CDCs in China. CDCs may reduce or cease the purchases if the patients do not accept these products or KOLs do not recommend YS Group's products. Failure to gain market acceptance would limit YS Group's ability to generate revenue as well as materially reduce its profitability.

In particular, CDCs and their physicians may elect not to recommend YS Group's products to patients for a variety of reasons, including the reimbursement policies of government and third-party payers, as well as the willingness of patients to pay out-of-pocket in the absence of such coverage reimbursement. There are other vaccines for the medical conditions that YS Group's marketed product and product candidates target. In

order to successfully launch a product, CDCs' physicians and patients must be educated about the relative benefits and advantages of YS Group's products over alternative products. If YS Group's products (including product candidates once commercialized) are not perceived to be user-friendly, present a lesser risk of side effects, or be more efficient or otherwise significantly better than other available products, YS Group's products may not be recommended or adopted by customers and end-users. A failure of YS Group's products to gain sufficient commercial acceptance would have a material adverse effect on its business, financial condition and results of operations. Even if YS Group's products achieve market acceptance, YS Group may not be able to maintain that market acceptance over time if new products or technologies are introduced that are more favorably received than its products, are more cost effective or render its products obsolete.

***If YS Group's marketed product and product candidates as well as the related manufacturing, storage, testing, delivery and other procedures do not meet the required quality standards, YS Group's business and reputation could be harmed, and its revenue and profitability could be materially and adversely affected.***

YS Group's marketed product and product candidates as well as the related manufacturing, storage, testing, delivery and other procedures are required to meet certain quality standards to ensure product safety and efficacy. YS Group cannot assure you that its quality control and assurance system can provide adequate and comprehensive protection against the associated risks at all time. YS Group's quality control and assurance policies and procedures may suffer from design deficiencies or fail to account for all risks in the manufacturing, storage, testing, delivery and other procedures. In addition, YS Group's quality control and assurance personnel may fail to comprehend the related policies and procedures, or implement such in a stringent and consistent manner at all time. For example, YS Group halted its production of marketed product for certain months in 2013 in order to address contamination issues. Moreover, YS Group cannot eliminate the risk of all errors, defects or failure, whether they are attributable to YS Group or third parties. Quality defects may be attributable to a number of reasons, including:

- manmade or naturally occurring errors and imprecision in the manufacturing, storage, testing, delivery and other procedures;
- technical or mechanical malfunctions in the manufacturing, storage, testing, delivery and other procedures;
- human error or malfeasance by YS Group's quality control, quality assurance, manufacturing, experiment and other personnel, as well as other responsible personnel of third parties;
- tampering by third parties;
- exposure to suboptimal manufacturing, storage, testing and delivery conditions or environment; and
- quality issues with the raw materials and consumables YS Group purchases or produce.

Failure to detect and cure quality defects in YS Group's vaccine products or to prevent such defective products from being delivered to end-users could result in patient injury or death, product recalls or withdrawals, license suspension or revocation, government investigations, legal actions, regulatory fines, or negative media coverage that could damage YS Group's reputation and business, expose YS Group to liability, and materially and adversely affect its revenue and profitability.

***YS Group's business may be materially and adversely affected by product recalls or defects in the biopharmaceutical industry, and any other scandals and incidents that negatively affect the reputation and public perception of the vaccine industry as a whole.***

Both the manufacturing and distribution processes of biopharmaceutical products are complex. In addition, biopharmaceutical products must be stored properly in order to remain safe and effective. In the past, major biopharmaceutical companies have had instances of widespread product recalls due to product defects. Such recalls have in the past at times been subject to widespread media attention. Such recalls could damage both the reputation of major biopharmaceutical manufacturers, as well as the biopharmaceutical industry as a whole. In addition, there have been scandals of poor handling of production of biopharmaceutical products by certain companies. For example, in 2018, the Changchun Changsheng vaccine scandal in China has caused widespread outrage where China's second largest rabies vaccine manufacturer allegedly violated GMP manufacturing protocols and regulations, which resulted in the production of defective vaccines.

Such incidents have caused, and any future similar incidents and any negative publicity regarding the biopharmaceutical industry could cause, reputational damage to the biopharmaceutical industry and could reduce the demand for biopharmaceutical products by creating negative public perception of vaccines. In addition, the government may promulgate new regulations and rules to reform, strengthen or change the existing supervision over the vaccine industry. If any of such event occurs, YS Group's business, financial condition and results of operations could be materially and adversely affected.

***YS Group's marketed product and product candidates may cause undesirable adverse events or have other properties that could delay or prevent their regulatory approval, limit the commercial profile of an approved label, or result in disputes, claims, litigations or other significant negative consequences following any regulatory approval.***

Undesirable adverse events caused by YS Group's product candidates could cause YS Group or regulatory authorities to interrupt, delay or halt clinical trials and could result in a more restrictive label or the delay or denial of regulatory approval by the NMPA in China, the HSA in Singapore, the U.S. FDA or other comparable regulatory authorities. Results of YS Group's trials could reveal a high and unacceptable severity or prevalence of adverse events, which could cause the suspension or termination of such trials, or the cessation of development and the denial of approval from relevant regulatory authorities. Undesirable adverse events caused by its products or product candidates may include but are not limited to, inflammatory response of certain organs. As most of YS Group's product candidates have not been testified in large-scale clinical trials, the adverse effect of such, especially that of long-term use, are uncertain. Certain types of disease may also not respond to YS Group's product candidates. In addition, combination therapy with other marketed products may cause uncertain adverse effect. Product-related adverse events could affect patient recruitment and the ability of enrolled subjects to complete the trial, and could result in potential product liability claims. Additionally, undesirable side effects or adverse events caused by or relating to YS Group's marketed product or product candidates may be discovered after they receive regulatory approval. Any of these occurrences may harm YS Group's reputation, business, financial condition and prospects significantly.

YS Group has become, and may continue to become subject to such negative events and consequences, including but not limited to the following:

- YS Group could be sued and held liable for the adverse events caused to subjects in clinical trials or patients and the relevant compensation, regardless whether a casual relationship can be proven;
- YS Group may suspend commercialization and marketing of the product;
- regulatory authorities may withdraw approvals of the product;
- YS Group is subject to regulatory seizure of its products;
- regulatory authorities may require additional warnings on the label;
- YS Group may be required to develop risk evaluation and mitigation strategies for the product, to incorporate additional requirements under such strategies, or to develop a similar strategy as required by a comparable regulatory authority;
- YS Group may be required to or propose by ourselves to conduct post-market studies; and
- YS Group could be prevented from achieving market acceptance of the particular product.

***The recession or eradication of the infectious diseases that YS Group's vaccines target may adversely affect its sales.***

YS Group has devoted significant resources to the research and development of vaccines against infectious diseases, and will continue to devote resources to the development of vaccines to address novel infectious diseases. However, a pandemic or type of infectious disease may have receded before YS Group realizes any return on its investment in the research and development of its vaccines. Moreover, diseases that YS Group's vaccines target may be eradicated, which would eliminate the market demand of YS Group's vaccines. In addition, outbreaks of infectious diseases may cause CDCs to significantly increase their purchases of vaccines against the pandemic diseases and reduce purchases of other vaccines in a short period. Changes of the procurement plans of CDCs could adversely affect sales of YS Group's vaccine products.

### **Risks Related to the Development of YS Group's Product Candidates**

*YS Group's success depends substantially on the success of its product candidates in preclinical or clinical trial stages. Preclinical or clinical trials involve a lengthy and expensive process with uncertain outcomes. YS Group may not be able to achieve its projected development goal of its product candidates in a timely manner or at all, which may materially and adversely affect YS Group's business, financial condition, results of operations and prospects.*

YS Group's business success will substantially depend on the successful development, regulatory approval and commercialization of its product candidates, particularly its lead product candidates, such as PIKA rabies vaccine, PIKA recombinant COVID-19 vaccine and PIKA YS-ON-001. These product candidates are still in preclinical or clinical studies. Before YS Group can generate revenue from sales of these product candidates, each of them will undergo the process of preclinical and/or clinical studies, regulatory approval in multiple jurisdictions, development of manufacturing supply and capacity, substantial investment and significant marketing efforts. YS Group has invested and will continue to invest a significant portion of its efforts and financial resources in the development of its existing lead product candidates. The success of YS Group's product candidates will depend on several factors, including:

- successfully enrolling and/or completing preclinical studies and clinical trials, as well as other studies required to obtain regulatory approval;
- obtaining regulatory approvals from applicable regulatory authorities for planned clinical trials, future clinical trials or product registrations, manufacturing and commercialization;
- establishing commercial manufacturing capabilities, either by building facilities ourselves or making arrangements with third-party manufacturers;
- relying on third parties to manage and conduct high-quality clinical trials safely and efficiently;
- obtaining and maintaining patent, trade secret and other intellectual property protection and regulatory exclusivity;
- ensuring that YS Group does not infringe, misappropriate or otherwise violate the patent, trade secret or other intellectual property rights of third parties;
- commercializing YS Group's product candidates;
- obtaining reimbursement from third-party payers for product candidates;
- obtaining and maintaining healthcare coverage and adequate reimbursement;
- competing with other products and product candidates in the market;
- successfully enforcing and defending intellectual property rights and claims; and
- achieving continued acceptable safety profile for YS Group's product candidates following regulatory approval.

After the consummation of the Business Combination, as a publicly listed company, YS Group may continue to make such disclosures of its expectations in this respect. The actual timing for achieving product development milestones could vary significantly from YS Group's expectations due to a number of factors, many of which are outside its control. There can be no assurance that YS Group's preclinical studies or clinical trials will be completed as planned or at all, or that YS Group will make regulatory submissions or receive regulatory approvals as planned, or that YS Group will be able to adhere to its current schedule for the launch of any of its products candidates. If YS Group fails to achieve one or more of these milestones as planned, it could adversely affect the price of its Shares and its business prospects.

*Preclinical and clinical studies involve a lengthy and expensive process with an uncertain outcome. YS Group may incur additional costs or experience delays in completing preclinical or clinical studies, or ultimately be unable to complete the development and commercialization of YS Group's product candidates.*

Before obtaining regulatory approval for the sale of YS Group's product candidates, YS Group must conduct extensive preclinical and clinical studies to demonstrate the safety and efficacy of its product candidates in



non-human and human subjects. Clinical testing is expensive, difficult to implement, can take many years to complete, and is uncertain as to outcome. A failure of one or more of YS Group's clinical trials can occur at any stage of testing. The outcome of preclinical testing and early clinical trials may not be predictive of the success of later clinical trials, and successful interim results of a clinical trial do not necessarily predict successful final results. Moreover, preclinical and clinical data are often susceptible to varying interpretations and analyses. YS Group may nonetheless fail to obtain regulatory approval of its product candidates dependent solely on the discretion of each regulatory body.

YS Group may experience delays in completing its preclinical or clinical studies and numerous unforeseen events could arise during, or as a result of, future clinical trials, which could delay or prevent YS Group from receiving regulatory approval of its product candidates. These factors include:

- regulators, institutional review boards (“IRBs”), or ethics committees may not authorize YS Group or its investigators to commence or conduct a clinical trial at a prospective trial site;
- regulatory authorities may disagree with or change their position on the acceptability of YS Group's trial designs or clinical endpoints;
- clinical trials may produce negative or inconclusive results, which could cause YS Group to conduct additional clinical trials or abandon product development programs;
- the number of patients required for clinical trials of YS Group's product candidates may be larger than it anticipates, enrollment in these clinical trials may be slower than it anticipates or participants may drop out of these clinical trials or fail to return for post-treatment follow-up at a higher rate than it anticipates;
- third-party contractors used in YS Group's clinical trials may fail to comply with regulatory requirements or meet their contractual obligations in a timely manner, or at all, or may deviate from the clinical trial protocol or drop out of the trial, which may require that YS Group adds new clinical trial sites or investigators;
- clinical trial sites may withdraw from YS Group's clinical trials as a result of changing standards of care or the ineligibility of a site to participate in YS Group's clinical trials;
- YS Group may fail to identify and maintain a sufficient number of trial sites;
- the ability to conduct a companion diagnostic test to identify patients who are likely to benefit from YS Group's product candidates;
- YS Group may elect, or be required to, suspend or terminate clinical research for various reasons, including non-compliance with regulatory requirements or a finding that participants are being exposed to unacceptable health risks;
- the cost of clinical trials of YS Group's product candidates may be greater than YS Group anticipates, and YS Group cannot obtain sufficient funds;
- the supply or quality of YS Group's product candidates or other materials necessary to conduct clinical trials of its product candidates may be insufficient or inadequate;
- YS Group's product candidates may have undesirable side effects or unexpected characteristics, causing the termination of such trials, or reports may arise from preclinical or clinical testing of other therapies that raise safety or efficacy concerns about YS Group's product candidates;
- YS Group may not complete preclinical or clinical trials as its originally scheduled;
- YS Group may encounter regulatory delays if a clinical trial is suspended or terminated due to various factors, including but not limited to a failure to conduct the clinical trial in accordance with regulatory requirements or the applicable clinical protocols, inspection of the clinical trial operations or trial site by regulatory authorities that results in the imposition of a clinical hold, unforeseen safety issues or adverse side effects, failure to demonstrate a benefit from using a product, changes in governmental regulations or administrative actions or lack of adequate funding to continue the clinical trial; and
- YS Group's preclinical and clinical studies may be hindered, delayed or prevented by the occurrence or influence of other incidents or negative events, such as the outbreak of COVID-19 and political conflicts between China and other countries.

Many of these factors that cause a delay in the commencement or completion of clinical trials may also ultimately lead to delay or denial of regulatory approval of YS Group's product candidates and increases in product development costs. Significant preclinical study or clinical trial delays also could allow YS Group's competitors to acquire more market shares, which may harm YS Group's ability to commercialize its product candidates and adversely affect YS Group's business and results of operations.

***Results of earlier clinical trials may not be predictive of results of later-stage clinical trials.***

The results of preclinical studies and early clinical trials of YS Group's product candidates may not be predictive of the results of later-stage clinical trials. Product candidates in later stages of clinical trials may fail to show the desired safety and efficacy traits despite having progressed through preclinical studies and initial clinical trials. Future clinical trial results may not be favorable for a variety of reasons. For example there can be significant variability in safety and/or efficacy results between different trials of the same product candidate due to numerous factors, including changes in trial procedures set forth in protocols, differences in the size and type of the subject populations, including genetic and biological differences and other trial protocols. Various aspects of the development program, such as manufacturing and formulation, may be altered along the way in an effort to optimize processes and results. Such changes may not achieve these intended objectives or more compliance expenses. In the case of any trials YS Group conducts, results may differ from earlier trials due to the larger number of participants and resulting complexity due to the involvement of diversified demographics, as well as the large number of clinical trial sites and additional countries and languages involved in such trials. Any of these changes could make the results of planned clinical trials or other future clinical trials YS Group may initiate less predictable and could cause YS Group's product candidates to perform differently, which could require additional governmental communications and procedures for the altered clinical trial plan, delay the completion of clinical trials, delay approval of YS Group's product candidates and/or jeopardize YS Group's ability to commence commercialization of its product candidates.

***If the targeted market for YS Group's product candidates does not grow as expected or declines, YS Group's ability to expand its business and results of operations could be materially and adversely affected.***

The targeted markets for YS Group's product candidates, including, among others, the vaccine and infectious drug market in Southeast Asia and China are evolving, the continued growth of which will depend on numerous factors, many of which are beyond YS Group's control, including but not limited to:

- development, safety and efficacy, availability and affordability of alternative therapeutics;
- perception, recognition and acceptance of vaccines by end-users, CDCs, KOLs and others related to the vaccine or disease prevention industry;
- technological and scientific advancements, as well as manufacturing, storage and transportation techniques related to vaccines;
- general awareness on public health;
- changes in demographic composition and structure;
- changes in government policy and utilization of resources on public health matters;
- the general economic condition in China and globally.

Any decline or slowdown in the growth of the vaccine industry could materially and adversely affect YS Group's ability to expand its business and generate positive operating results.

***YS Group may not be successful in its efforts to identify or discover additional product candidates. Due to YS Group's limited resources and access to capital, YS Group must, and have in the past decided to, prioritize the development of certain product candidates. These decisions may prove to have been wrong and may adversely affect YS Group's business.***

YS Group intends to explore other biopharmaceutical opportunities in addition to YS Group's existing product candidates. However, YS Group may fail to identify other product candidates for clinical trials for a number of reasons, such as research methodology, harmful side effects or certain regulatory requirement. There can be no assurance that YS Group will ever be able to identify additional biopharmaceutical

opportunities for its product candidates or develop suitable potential product candidates. If YS Group does not accurately evaluate the commercial potential or target market for a particular product candidate, YS Group may derive less value from that product candidate through collaboration, licensing or other royalty arrangements, as compared to retaining sole development and commercialization rights to such product candidate.

Because YS Group has limited financial and managerial resources, it must limit its licensing, research and development programs to specific product candidates that it identifies for specific indications. For example, YS Group has focused on developing its PIKA immunomodulating technology platform, which it believes has great potential to create a wide variety of innovative immunological biologics to address underserved medical needs in treating and preventing infectious diseases and cancer. However, YS Group may focus its efforts and resources on product candidates or other potential programs that ultimately prove to be unsuccessful or generate less return than expected, which may cause YS Group to forego or delay pursuit of more successfully product development opportunities. YS Group's resource allocation decisions may cause YS Group to fail to capitalize on viable products or profitable market opportunities.

***YS Group may rely on third parties to monitor, support and/or conduct preclinical or clinical trials of its product candidates. If the preclinical and clinical trial organizations do not perform in an acceptable manner, YS Group may be unable to develop and commercialize its candidates as anticipated.***

YS Group may rely on academic institutions, CROs, hospitals, clinics and other organizations and institutions, who are beyond YS Group's control, to monitor, support, conduct preclinical and/or clinical studies of its product candidates. As a result, YS Group has less control over the quality, timing and cost of these studies and the ability to recruit trial subjects than if it conducts these trials wholly by ourselves. If YS Group is unable to maintain or enter into agreements with these third parties on acceptable terms, or if any such engagement is terminated, YS Group may be unable to enroll subjects on a timely basis or otherwise conduct its trials in the manner it anticipates. In addition, there is no guarantee that these third parties will devote adequate time and resources to YS Group's studies or perform as required by a contract or in accordance with regulatory requirements, including maintenance of clinical trial information regarding YS Group's future product candidates. If these third parties fail to meet expected deadlines, timely transfer to YS Group any regulatory information, adhere to protocols or act in accordance with regulatory requirements or YS Group's agreements with them, or if they otherwise perform in a substandard manner or in a way that compromises the quality and/or accuracy of their activities and/or the data they obtain, then clinical trials of YS Group's future product candidates may be extended, delayed or terminated, or YS Group's data may be rejected by the NMPA, the HSA or other regulatory agencies.

***Restrictions imposed by YS Group's outstanding indebtedness and any future indebtedness may limit YS Group's ability to operate its business and to finance its future operations or capital needs.***

In March 2022, YS Group completed a \$40 million royalty-based 4.5-year long-term debt transaction with R-Bridge Investment Holdings Pte. Ltd. The terms of the loan facility limit YS Group's ability to, among other things, incur additional indebtedness, incur liens on YS Group's assets, engage in consolidations, mergers, liquidations, dissolutions, sell or otherwise dispose of YS Group's assets, acquire other businesses, make loans, capital contributions, or other investments, or enter into any other transactions outside of the ordinary course of business. In addition, YS Group is obliged to pay shall pay royalties based upon YS Group's annual Net Sales (as defined in the royalty deed dated March 16, 2022 entered into between HK Yisheng and R-Bridge Healthcare Fund, LP) by multiplying the applicable royalty rate by the corresponding amount incremental Net Sales for that financial year. The terms of YS Group's loan facilities and royalty obligations restrict YS Group's current and future operations and could adversely affect YS Group's ability to finance its future operations or capital needs or take advantage of financing opportunities, mergers, acquisitions, investments, and other corporate opportunities that may be beneficial to YS Group's business. In addition, complying with these covenants may make it more difficult for YS Group to successfully execute its business strategy and compete against companies which are not subject to such restrictions.

**Risks Related to Extensive Government Regulations**

***The biopharmaceutical industry is highly regulated. The relevant regulations and policies are complex and regional and subject to changes from time to time. YS Group's ability to obtain and maintain these regulatory approvals is uncertain. Any change in government regulation and policy may place additional burdens on YS Group's business and have a material adverse effect on YS Group's financial condition and results of operations.***

The biopharmaceutical industry is subject to extensive government regulation and supervision, which addresses all aspects of operations in the biopharmaceutical industry, including but not limited to approval, production, distribution, packaging, labeling, storage and shipment, advertising, licensing and certification requirements and procedures, periodic renewal and reassessment processes, registration of new drugs and environmental protection. For example, in order to manufacture and market any immunological biologics in China, a pharmaceutical company is required to obtain permits and certificates from the NMPA, including but not limited to the drug registration certificate (where applicable), the drug manufacturing license, and to pass the initial GMP inspections and continued compliance with the GMP, as well as other manufacturing requirements for its manufacturing facilities. The drug registration certificate and the drug manufacturing license are subject to renewal periodically. In addition, a vaccine manufacturer is also required to obtain lot release for each lot of vaccine products before they can be released to the market. Violation of applicable laws, rules and regulations by YS Group may lead to its failure to obtain or renew permits, licenses or approvals required for operation in a timely manner or on commercially reasonable terms. As a result, YS Group will not be able to engage in or have to suspend or cease the manufacture or sale of any products, which may have a material adverse effect on YS Group's business, financial condition, results of operations and prospects.

YS Group's ability to manufacture its marketed product and its future approved product candidates depends on its ability to develop, validate and maintain commercially viable manufacturing processes that are compliant with GMP regulations. For example, YS Group halted its production of marketed product for certain months in 2013 in order to address contamination issues. YS Group cannot assure you that it will be able to maintain required certificate or continue to meet the GMP requirements enacted by the drug regulatory authority, which may cause YS Group to suspend or terminate the manufacturing and commercialization of its marketed products, and materially and adversely affect its business, financial condition and results of operations.

The NMPA may also withdraw approval if compliance with regulatory requirements and standards is not maintained or if problems occur after YS Group's products reach the market. In addition, later discovery of previously unknown problems with YS Group's marketed product, including adverse events of unanticipated severity or frequency, or with YS Group's manufacturing processes, or failure to comply with regulatory requirements, may result in revisions to the approved labeling to add new safety information, imposition of post-market studies (including but not limited to clinical studies) to assess new safety risks, or imposition of distribution restrictions or other restrictions under a risk evaluation and mitigation program. YS Group cannot predict the likelihood, nature or extent of government regulation that may arise from future legislation or administrative action. If YS Group is slow or unable to adapt to changes in existing requirements or the adoption of new requirements or policies, or if YS Group is not able to maintain regulatory compliance, YS Group may lose any regulatory approval that it may have obtained and it may not achieve or sustain profitability.

In addition, regulatory requirements and approval process varies among countries, jurisdictions and regions, which may involve additional product testing and validation and additional administrative review periods. YS Group's product candidates may need to apply for and obtain approval from multiple jurisdictions where it plans to study or market the products, which may be costly and time-consuming. Even if product candidates successfully complete clinical trials in one country, there is no assurance that clinical trials of the same product conducted with patients in other countries will be successful. Moreover, any safety issues, product recalls or other incidents related to products approved and marketed in one jurisdiction may impact approval of those products in another jurisdiction. If YS Group is unable to obtain regulatory approval for its product candidates in one or more jurisdictions, or any approval contains significant limitations, or are imposed on certain product candidates, YS Group may not be able to obtain sufficient funding or generate sufficient revenue to continue the development of its product candidates or any other product candidate that it may in-license, acquire or develop in the future. The regulatory framework governing the biopharmaceutical industry is also subject to change and amendment from time to time. Any regulatory changes or amendment may materially and adversely impact YS Group's business, financial condition, results of operations and prospects.

***YS Group's marketed product and product candidates may become subject to unfavorable pricing regulations, third-party reimbursement practices or healthcare reform initiatives, which could harm YS Group's business.***

The regulations that govern regulatory approvals, pricing and reimbursement for new immunological biologics vary widely from country to country. YS Group might obtain regulatory approval for a drug in a particular country, but then be subject to price regulations that delay YS Group's commercial launch of the drug and negatively impact the revenues it is able to generate from the sale of the drug in that country. Adverse pricing limitations may hinder YS Group's ability to recoup its investment in its marketed product and/or one or more product candidates, even if they obtain regulatory approval. For example, according to Opinions on Reforming the Review and Approval System for Pharmaceutical Products and Medical Devices, issued by the State Council in August 2015, the enterprises applying for drug approval in China will be required to undertake that the selling price of new drugs on the PRC market shall not be higher than the price of the product in its country of origin or the comparable market prices of the products in China's neighboring markets, as applicable.

YS Group's ability to commercialize any product successfully also will depend in part on the extent to which reimbursement for such product and related treatments will be available from government health administration authorities, private health insurers and other organizations. Patients who are provided medical treatment for their conditions generally rely on third-party payers to reimburse all or part of the costs associated with their treatment. Government authorities and third-party payers, such as private health insurers and health maintenance organizations, decide which products and treatments they will cover and the amount of reimbursement, which is critical to market acceptance of new products. There may be significant delays in obtaining reimbursement for approved product candidates, and coverage may be more limited than the purposes for which the product is approved by regulatory authorities. Moreover, eligibility for reimbursement does not imply that any product will be paid for in all cases or at a rate that covers YS Group's costs. Interim payments for new products, if applicable, may also not be sufficient to cover YS Group's costs and may not be made permanent. Payment rates and third-party payer coverage may be reduced for a number of commercial and regulatory reasons, all of which may adversely affect the commercialization of YS Group's marketed product or any product candidate.

As YS Group intends to seek approval to market its marketed product and product candidates in multiple jurisdictions, it will be subject to various rules and regulations regarding coverage and reimbursement. Moreover, eligibility for reimbursement in China, Singapore or other jurisdictions does not imply that any product will be paid for in all cases or at a rate that covers YS Group's costs, including licensing fees, research, development, manufacture, sale and distribution. Reimbursement rates may vary according to the use of the product and the clinical setting in which it is used, may be based on reimbursement levels already set for lower cost products and may be incorporated into existing payments for other services. Moreover, in many jurisdictions, the pricing of products and biologics is subject to governmental control. In these countries, pricing negotiations with governmental authorities can take considerable time after obtaining regulatory approval of a product candidate. As a result, net prices for products may be reduced by mandatory discounts or rebates required by government healthcare programs, or private payers in the case of third-party reimbursement.

YS Group's marketed product or product candidates may not be included in the list of products that can be reimbursed by mandatory medial insurance in China. YS Group cannot be sure that reimbursement will be available for any product that it commercializes and, if reimbursement is available, what the level of reimbursement will be. The price for rabies vaccine in China also increases significantly. For instance, the median bidding price of rabies vaccine under Vero cell line per has increased steadily in China in the past five years, growing from RMB53.0 in 2017 to RMB70.0 in 2020, and further to RMB87.0 in 2021, according to the F&S Report. Patients may be unlikely to use certain of YS Group's marketed product and product candidates if coverage is not provided and reimbursement is inadequate to cover a significant portion of the cost of such marketed product and product candidates. Because some of YS Group's marketed product and product candidates have a higher cost of goods than conventional therapies, and may require long-term follow up evaluations, the risk that coverage and reimbursement rates may be inadequate for YS Group to achieve profitability may be greater. In addition, YS Group's inability to promptly obtain coverage and profitable payment rates from both government-funded and private payers for any approved products could have a material adverse effect on its results of operations, its ability to raise capital needed to commercialize product

candidates and its overall financial condition. Obtaining reimbursement for YS Group's marketed product may be particularly difficult because of the higher prices often associated with products administered under the supervision of a physician. Therefore, the availability of third-party reimbursement may significantly impact the demand for, or the price of, any product for which YS Group obtains regulatory approval. If reimbursement is not available or is available only to limited levels, YS Group may not be able to successfully commercialize its marketed product or any product candidate that it successfully develops, which could have a material adverse effect on YS Group's results of operations, its ability to raise capital needed to commercialize product candidates and its financial condition.

***YS Group may not be able to be successfully prequalified by province-level CDCs of its target provinces or secure subsequent product orders.***

YS Group expects the county-level CDCs, to be its primary customers in Chinese market. YS Group is focused on China's private vaccine market, and substantially all of its marketed product and product candidates are required to be prequalified by province-level CDCs of YS Group's target provinces through a bidding process before undertaking any sales. The province-level CDCs usually select one or more suppliers for the same type of vaccines, taking into consideration, among other things, the quality and price of the products and the service and reputation of the suppliers. YS Group may be unsuccessful in winning bids in the tender process to prequalify its products at the provincial level. If YS Group fails to obtain the required prequalification, it will lose market share to its competitors, and YS Group's revenue and profitability will be adversely affected. Even if YS Group's vaccines are prequalified, YS Group cannot guarantee that it will be able to secure purchase orders from county-level CDCs. If CDCs do not purchase YS Group's products, or the purchase volume is lower than expected, its business, financial conditions and results of operations would be adversely affected.

***YS Group's sales to CDCs subject YS Group to certain risks related to doing business with public authorities.***

YS Group sells its vaccine products in China to CDCs and participate in public tenders hosted by them, which exposes YS Group to certain risks related to doing business with public authorities. For example, although YS Group signs contracts with them for sales of its vaccine products, and such contracts generally stipulate the payment time and method as well as dispute resolution, YS Group has little or no control over their procurement decisions or payment cycles, and the CDCs that contract to purchase YS Group's products may reduce or cancel orders, or demand price adjustments or other changes to their contracts with YS Group without its consent. Changes in the personnel of CDCs that purchase YS Group's products may result in changes or delays to, or cancellations of, their purchase commitments due to, among others, differing policy and budgetary agendas of the personnel involved. Any of the foregoing actions taken by the authorities could have a material adverse effect on YS Group's results of operations and expected earnings, or result in its failure to meet, or having to adjust downwards, its sales estimates.

In addition, many of the remedies that are available to YS Group when dealing with private parties, such as making claims for breach of contract or taking other legal actions, may not be practicable in YS Group's dealings with CDCs. For example, in the event of any dispute with a CDC, YS Group may find it not in its best interest to take formal legal actions against the CDC and may, instead, resolve such disputes through other means, such as negotiations or third-party mediations. Therefore, YS Group cannot assure you that results from such processes will be the same as or more favorable to YS Group than those YS Group would have obtained in formal legal proceedings.

***YS Group has been involved, and may continue to be involved, in claims, disputes, litigation, arbitration or other legal and administrative proceedings in the ordinary course of business.***

YS Group has been involved, and may continue to be involved, in claims, disputes, litigation, arbitration or other legal and administrative proceedings in its ordinary course of business. These may concern issues relating to, among others, quality issues relating to YS Group's marketed product and product candidates, the manufacturing, storage, logistics and commercialization processes relating to its marketed product and product candidates, administrative actions, authority, procedures and decisions, product liability, environmental matters, breach of contract, construction projects, employment or labor disputes, and infringement of intellectual property rights.

YS Group is not involved in any ongoing litigations and legal proceedings that would materially and adversely affect the commercialization and research and development of YS Group's product and product candidates, or its business and results of operations. However, YS Group cannot assure you that there will be no future disputes, litigation, arbitration, administrative investigation or other legal and administrative proceedings initiated by YS Group or brought against YS Group, with or without merit. YS Group may involve additional administrative proceedings against it or initiated by YS Group against the competent regulatory authorities to protect its legal rights and interests in the future. Any such claims, disputes or legal proceedings may result in substantial costs, disruption of YS Group's business operations, diversion of resources and material harm to YS Group's reputation. Furthermore, claims, disputes or legal proceedings against YS Group may be due to defective supplies sold to YS Group by YS Group's suppliers, who may not be able to indemnify YS Group in a timely manner, or at all, for any costs that YS Group incurs as a result of such claims, disputes and legal proceedings.

***YS Group may not be able to manage its sales and marketing personnel effectively, and may consequently be subject to penalties pursuant to anti-corruption laws. YS Group's reputation, business, prospects and brand may be materially and adversely affected by actions taken by them.***

YS Group is subject to anti-bribery laws in China that generally prohibits companies and their intermediaries from making payments, offering property or other illegal benefits to government officials for the purpose of obtaining or retaining business or securing any other improper advantage. Although YS Group has policies and procedures designed to ensure that its employees and its agents comply with anti-bribery laws, there is no assurance that such policies or procedures will prevent YS Group's agents, employees and intermediaries from engaging in bribery activities. For example, although YS Group's company policies prohibit employees from making improper payments to CDCs or otherwise engaging in improper activities to influence the procurement decisions of drug products by CDCs, YS Group may not be able to manage its sales and marketing employees effectively, as their compensation is primarily linked to their performance. Historically, certain former employees engaged in related misconducts and these former employees have been prosecuted. YS Group has taken enhanced internal control measures, including setting up supervision group, reinforcing internal auditing efforts, and enhancing training and education in respect of anti-corruption laws to its employees. YS Group cannot assure you that these enhanced internal control measures will avoid the occurrence of similar events in the future or its employees will not violate the anti-bribery laws of China, the United States and other jurisdictions. Such violations could have a material adverse effect on YS Group's reputation, business, prospects and brand. Moreover, YS Group could be liable for actions taken by these employees, including any violation of applicable laws in connection with the marketing or sales of products, such as China's anti-corruption laws and the Foreign Corrupt Practices Act of the United States, or the FCPA. In particular, if employees make any payments that are forbidden under the FCPA, YS Group could be subject to civil and criminal penalties imposed by the U.S. government. In addition, PRC laws regarding what types of payments to promote or sell products are impermissible in the pharmaceutical industry are not always clear. As a result, YS Group, its employees or affiliates could make certain payments in connection with the promotion or sales of YS Group's products or other activities involving YS Group's products which at the time are considered by YS Group to be legal but are later deemed impermissible by the PRC government. Any of the circumstances may materially and adversely affect YS Group's business, results of operations and financial condition.

Failure to comply with anti-bribery laws could disrupt YS Group's business and lead to severe criminal and civil penalties, including imprisonment, criminal and civil fines, loss of export licenses, and suspension of YS Group's qualification to do business with government authorities and CDCs. Other remedial measures may include further changes or enhancements to YS Group's procedures, policies, and controls and potential personnel changes and/or disciplinary actions, any of which could have a material adverse effect on YS Group's business, financial condition, results of operations and liquidity. YS Group's reputation could be tarnished by any allegation or impropriety that YS Group violated or may have violated such laws.

***Product liability claims or lawsuits could cause YS Group to incur substantial liabilities.***

YS Group faces an inherent risk of product liability exposure related to the use of its marketed product and the use of its product candidates in clinical trials or any product candidates. YS Group has been and may in the future continue to be involved in product liability claims from time to time. Historically, YS Group

encountered certain civil and administrative proceedings in respect of its products. If YS Group cannot successfully defend against claims that the use of such product or product candidates, including any of its product candidates that have received regulatory approval, caused injuries, YS Group could incur substantial liabilities. YS Group may be held liable and/or suffer reputation damage even if YS Group is not at fault. Regardless of merit or eventual outcome, liability claims may result in:

- decreased demand for YS Group’s marketed product and product candidates;
- product recalls, withdrawals or labeling, marketing or promotional restrictions;
- significant negative media attention and reputational damage;
- withdrawal of clinical trial participants and inability to continue clinical trials;
- significant costs to defend the related litigation;
- substantial monetary awards to trial participants or patients;
- inability to commercialize any product candidates that YS Group may develop;
- initiation of investigations by regulators;
- a diversion of management’s time and YS Group’s resources; and
- a decline in YS Group’s Share price.

The Vaccine Administration Law of the PRC (the “VAL”), which was promulgated on June 29, 2019 and came into effect on December 1, 2019, requires YS Group to have compulsory liability insurance to cover vaccines product liability claims. The specific measures for implementing the compulsory liability insurance system for vaccines shall be formulated by the drug administrative department of the State Council in conjunction with the competent health department of the State Council and the insurance regulatory authority. To be implemented, the NMPA published a draft of the Administrative Measures on Vaccines Liability Compulsory Insurance for public comments in October 2020. To date, the draft has not become effective. Once passed, it will function jointly with the VAL to regulate the purchase of vaccines liability compulsory insurance, among others, including the liability limitation and methods for covering insurance. As these laws and regulations are relatively new and evolving, it is uncertain and in flux how the insurance companies and the governmental authorities will implement and carry out them in practice. YS Group cannot assure you that it will be fully compliant with these requirements, or that it will be able to enter into insurance agreements on commercially reasonable terms or at all, or that available insurance policies will fully cover YS Group’s potential liabilities arising from its approved vaccines. As of the date of this proxy statement/prospectus, YS Group had maintained compulsory liability insurance for YSJA™ rabies vaccine in China. In addition, YS Group maintains liability insurance for its ongoing clinical trials (which covers the patient human clinical trial liabilities including, among others, bodily injury) in accordance with the relevant local laws and regulations where they are conducted. However, YS Group’s insurance coverage may not fully cover its potential liabilities. Inability to obtain sufficient insurance coverage at an acceptable cost or otherwise to protect against potential product liability claims could prevent or inhibit the commercialization of products YS Group develops, alone or with its collaborators.

***YS Group may be restricted from transferring its scientific data abroad and subject to regulations on human genetic resources.***

On March 17, 2018, the General Office of the State Council promulgated the Measures for the Management of Scientific Data (the “Scientific Data Measures”), which provides a broad definition of scientific data and relevant rules for the management of scientific data. According to the Scientific Data Measures, enterprises in China must seek governmental approval before any scientific data involving a “state secret” may be transferred abroad or to foreign parties. Further, any researcher conducting research funded at least in part by the Chinese government is required to submit relevant scientific data for management by the entity to which such researcher is affiliated before such data may be published in any foreign academic journal. Although vast majority of the R&D projects have been funded by YS Group since the inception of the company, certain R&D projects were partially benefited from grants provided by Chinese governments. As of the date of this proxy statement/prospectus, YS Group has not provided any scientific data involving “state secret” in the course of foreign communication and cooperation, and therefore YS Group believes that it does not need to



obtain relevant permission and approvals pursuant to the Scientific Data Measures. Given the term “state secret” is not clearly defined in the Scientific Data Measures, YS Group cannot assure you that it can always identify if there is any “state secret” in its scientific data and obtain relevant approvals for sending scientific data (such as the results of YS Group’s preclinical studies or clinical trials conducted within China) abroad or to its foreign partners. If YS Group is unable to obtain necessary approvals in a timely manner, or at all, its research and development of product candidates may be hindered, which could materially adversely affect YS Group’s business, financial condition, results of operations and prospects. If the relevant government authorities consider the transmission of YS Group’s scientific data to be in violation of the requirements under the Scientific Data Measures, YS Group may be subject to rectification and other administrative penalties imposed by those government authorities.

According to the Regulation on the Management of Human Genetic Resources, as promulgated by the State Council on May 28, 2019, which became effective on July 1, 2019, in case that foreign organizations and institutions established or actually controlled by foreign organizations or individuals intend to use PRC human genetic resources to carry out scientific research activities, such activities shall abide by PRC laws and regulations and carried out in cooperation with scientific research institutions, higher education institutions, medical institutions and enterprises in China. Where clinical institutions, in order to obtain the marketing licenses of relevant drugs and medical devices in China, makes use of PRC human genetic resources to carry out international cooperation in clinical trials in clinical institutions not involving the exit of PRC human genetic resource materials, approval is not needed. Instead, the cooperation parties shall, before conducting clinical trials, submit the types, quantities and uses of the human genetic resources involved to the administrative department of science and technology for filing. The Implementing Rules of the Regulation on the Management of Human Genetic Resources (Draft for Comments), which further specify the definition of foreign entities, filing of international cooperation and relevant administrative penalties, was promulgated on March 21, 2022. As of the date of this proxy statement/prospectus, YS Group’s current clinical trials in China, which involve PRC human genetic resources, are conducted in an international cooperation manner between YS Group and PRC institutions and enterprises, and such cooperation has been approved by or filed with the competent authority. However, as uncertainties exist regarding the final form of the regulation as well as the interpretation and implementation thereof before promulgation, YS Group cannot assure you that it has been and will be fully in compliance with these regulations, including obtaining the filings or approvals in a timely manner or at all. Any failure to be compliant with these regulations may result in various penalties or other regulatory actions being imposed on YS Group, such as confiscation of the revenues that were generated through the unauthorized activities, the imposition of fines, which could have an adverse effect on YS Group’s business and results of operations.

***YS Group and its CROs are subject to stringent privacy laws, information security policies and contractual obligations related to data privacy and security, and YS Group may be exposed to risks related to its management of the medical data of subjects enrolled in YS Group’s clinical trials and other personal or sensitive information.***

YS Group’s CROs, on behalf of YS Group, routinely receive, collect, generate, store, process, transmit and maintain medical data treatment records and other personal details of subjects enrolled in YS Group’s clinical trials, along with other personal or sensitive information. As such, YS Group and its CROs are subject to the relevant data protection and privacy laws, directives, regulations and standards that apply to the collection, use, retention, protection, disclosure, transfer and other processing of personal data in the jurisdictions in which YS Group operates and conduct its clinical trials, as well as contractual obligations. These data protection and privacy law regimes continue to evolve and may result in ever-increasing public scrutiny and escalating levels of enforcement and sanctions and increased costs of compliance. Failure to comply with any of these laws could result in enforcement action against YS Group, including fines, imprisonment of company officials and public censure, claims for damages by customers and other affected individuals, damage to YS Group’s reputation and loss of goodwill, any of which could have a material adverse effect on YS Group’s business, financial condition, and results of operations or prospects.

Such data protection and privacy laws and regulations generally require clinical trial sponsors and operators and their personnel to protect the privacy of their enrolled subjects and prohibit unauthorized disclosure of personal information. If such institutions or personnel divulge the patients’ private or medical records without their consent, they will be held liable for damage caused thereby. While YS Group has taken measures to maintain the confidentiality of the medical records and personal data of patients enrolled in its clinical trials,

these measures may not be always effective. YS Group’s information technology systems could be breached through hacking activities, and personal information could be leaked due to theft or misuse of personal information arising from misconduct or negligence. In addition, YS Group’s clinical trials also involve professionals from third party institutions. YS Group cannot ensure that such persons will always comply with its data privacy measures. Furthermore, any change in such laws and regulations could affect YS Group’s ability to use medical data and subject YS Group to liability for the use of such data for previously permitted purposes. Any failure to protect the confidentiality of patients’ medical records and personal data, or any restriction on or liability as a result of, YS Group’s use of medical data, could have a material adverse effect on its business, financial condition and results of operations.

Moreover, regulatory authorities in China have implemented and are considering to implement a number of additional legislative and regulatory proposals concerning data protection. For instance, the PRC Cyber Security Law, which became effective in June 2017, created China’s first national-level information security classified protection system for “network operators”, which may include all entities in China that own, manage provide services or use over the internet or other information networks. Drafts of some department regulations for such protection have been published, including the Data Security Management Measures (Draft for Comments) published in May 2019, which may, upon issuance, require security review before transferring human health-related data out of China. On July 7, 2022, the Cyberspace Administration of China published Outbound Data Transfer Security Assessment Measures, which became effective on September 1, 2022 and outlined the security assessment process for outbound data transfer. In addition, certain industry-specific laws and regulations may affect the collection and transfer of personal data in China, such as the Regulation on the Management of Human Genetic Resources. It is possible that these laws, regulations and guidelines may be interpreted and applied in a manner that is inconsistent with YS Group’s practices, which could potentially result in confiscation of YS Group’s human genetic resource samples and associated data and subject YS Group to administrative fines, penalties and negative publicity.

***YS Group’s business operations are subject to the regulatory, economic, environmental, and competitive conditions and changes within the Southeast Asia region.***

YS Group intends to expand its business and operation to overseas markets such as Southeast Asian countries, and thus may be governed by the laws, regulations and government policies in relevant Southeast Asia jurisdictions, and its business and future growth is dependent on the political, economic, regulatory and social conditions in these countries. There may also be political and social factors influencing government policy-making in the future that will lead to a major shift towards a higher degree of governmental control over biopharmaceutical industry in the relevant jurisdictions. Such a shift may reduce YS Group’s profitability in the long run and hence have an adverse effect on its financial condition, results of operations and prospects. In addition, competition laws and regulations of certain Southeast Asia countries may limit its growth and subject YS Group to antitrust and merger control investigations. YS Group may be subject to financial or other penalties or are prohibited from engaging in certain types of businesses or practices as a result of such investigations. After the consummation of the Business Combination, YS Biopharma and its subsidiaries will be governed by the laws, regulations and government policies in relevant Southeast Asia jurisdictions, and its business and future growth is dependent on the political, economic, regulatory and social conditions in these countries. Any material changes in the regulatory, economic, environmental or competitive conditions in those countries may also have a material adverse effect on its business, financial condition, results of operations, cash flows and prospects.

***If YS Group fails to comply with environmental, health and safety laws and regulations of the PRC, it could become subject to fines or penalties or incur costs that could have a material adverse effect on the success of its business.***

YS Group is subject to numerous environmental, health and safety laws and regulations, including those governing laboratory and manufacturing procedures and the handling, use, storage, discharge, treatment and disposal of hazardous materials, sewage and wastes. Its operations primarily occur in China and involve the use of hazardous materials, including chemical materials. Its operations also produce hazardous products and waste. YS Group is therefore subject to PRC laws and regulations concerning the discharge of hazardous materials, wastewater, gaseous waste and solid waste during its processes of research and development of products. YS Group has engaged competent third party contractors for the transfer and disposal of these

materials and wastes. However, it may not guarantee you that it, at all times, has complied or would comply fully with relevant regulations. Any violation of these regulations may result in substantial fines, criminal sanctions, revocations of operating permits, shutdown of YS Group's facilities and obligation to take corrective measures.

YS Group cannot assure you of the elimination of the risk of contamination or injury from these materials. In the event of contamination or injury resulting from its use of hazardous materials or its or third parties' disposal of hazardous materials, it could be held liable for any resulting damages, and any liability could exceed its resources.

Although YS Group maintains workers' compensation insurance to cover costs and expenses incurred due to on-the-job injuries to its employees and third party liability insurance for injuries caused by unexpected seepage, pollution or contamination, such insurance may not provide adequate coverage against potential liabilities. Furthermore, the PRC government may take steps towards the adoption of more stringent environmental regulations. Due to the possibility of unanticipated regulatory or other developments, the amount and timing of future environmental expenditures may vary substantially from those currently anticipated. If there is any unanticipated change in the environmental regulations, YS Group may need to incur substantial capital expenditures to install, replace, upgrade or supplement its manufacturing facilities and equipment or make operational changes to limit any adverse impact or potential adverse impact on the environment in order to comply with new environmental protection laws and regulations. If such costs become prohibitively expensive, YS Group may be forced to cease certain aspects of its business operations.

***The pharmaceutical industry in China is highly regulated and such regulations are subject to change which may affect approval and commercialization of YS Group's marketed product and product candidates.***

The pharmaceutical industry in China is subject to comprehensive government regulation and supervision, encompassing the approval, registration, manufacturing, packaging, licensing and marketing of new drugs and vaccines and their development. In recent years, the regulatory framework in China regarding the pharmaceutical industry has undergone significant changes, and YS Group expects that it will continue to undergo significant changes. Any such changes or amendments may result in increased compliance costs on YS Group's business or cause delays in or prevent the successful development or commercialization of its product and product candidates in China and reduce the current benefits it believes are available to YS Group from development and manufacturing in China. Chinese authorities have become increasingly vigilant in enforcing laws in the pharmaceutical industry and any failure by YS Group or its partners to maintain compliance with applicable laws and regulations or obtain and maintain required licenses, permits and filings may result in the suspension or termination of YS Group's business activities in China. YS Group believes its strategy and approach is aligned with the Chinese government's policies in all material respects, but it cannot ensure that its strategy and approach will continue to be aligned.

#### **Risks Related to Manufacturing and Commercialization**

***YS Group currently relies on the manufacturing facilities for the marketed product and are still in the process of developing additional facilities at other sites. Any disruption of YS Group's current and new facilities or their failure to meet GMP regulatory compliance or other regulatory requirements may have a material adverse effect on YS Group's business, financial condition and results of operations.***

There are multiple manufacturing plants in Shenyang which are currently producing its marketed product and clinical samples. YS Group plans to expand/upgrade productivity based on its current manufacture site in Shenyang and Singapore for manufacturing its marketed product and product candidates in the future. Upon completion of the manufacturing process, YS Group first stores the finished goods of its vaccine products in its Shenyang facilities, which are then shipped to YS Group's regional facilities for temporary transit storage before subsequent delivery. YS Group does not maintain back-up facilities, and depend on current facilities for the continued operation of its business. Natural disasters or other unanticipated catastrophic events, including power interruptions, water shortage, storms, fires, earthquakes, terrorist attacks and wars, as well as changes in governmental planning for the land underlying these facilities, could significantly impair the ability of YS Group to manufacture products and operate business and destroy any inventory located in those

facilities. The occurrence of such an event could significantly disrupt YS Group's business and materially reduce its revenues and profitability.

In addition, YS Group is required to comply with applicable GMP and other regulatory requirements, including regulatory standards with respect to manufacturing process or product quality and safety, cold-chain logistics during product delivery, and the corresponding maintenance, recordkeeping and documentation standards. YS Group's manufacturing facilities must be approved by governmental authorities before YS Group may use them to commercially manufacture products and are subject to inspection by regulatory agencies. Moreover, YS Group's marketed product must pass quality inspection prior to being permitted to hit the market for sale. Any changes in or updates to the GMP standards could impose higher or different regulatory requirements on YS Group's manufacturing, such as the manufacturing process, standard, technology, personnel and facilities, and YS Group cannot assure you that it will be able to meet the regulatory changes in a timely manner or at all, which could materially and adversely affect YS Group's business operations, results of operations, reputation and prospects. YS Group is also responsible for maintaining effective cold-chain logistics during the vaccine transportation process to the county-level CDCs. If YS Group fails to comply with applicable regulatory requirements at any stage during the manufacturing and transportation process, such as, regulatory standards with respect to manufacturing and transportation processes or product quality, safety and potency, YS Group may be subject to sanctions which could be severe, including but not limited to:

- monetary penalties;
- product recalls or seizure;
- injunctions;
- refusal of regulatory agencies to review pending manufacturing approval applications or supplements to approval applications;
- total or partial suspension of production;
- confiscation of products;
- withdrawals, revocation or non-renewal of approvals, license or permits previously issued; and
- criminal prosecution.

Any disruptions or delays at YS Group's facilities or their failure to meet GMP regulatory compliance or other regulatory requirements would also impair YS Group's ability to develop and commercialize its product and product candidates, which would adversely affect YS Group's business and results of operations.

***Real or perceived incidents of product contamination caused by YS Group's marketed product could materially and adversely affect its reputation, results of operations and financial conditions, and subject YS Group to regulatory actions and contractual liabilities.***

Product safety and quality is critical to YS Group's business. For example, YS Group's production were halted for certain months in 2013 in order to address contamination issues. YS Group cannot assure you that it will not encounter similar incidents in the future. YS Group's reputation, results of operations and financial condition could be materially and adversely affected by product contamination and its association with any contamination incidents. In addition, the mere publication of information or speculation asserting that YS Group's marketed product contains or has contained any contaminants, over which YS Group has no control, could damage YS Group's reputation and have a material adverse effect on YS Group, regardless of whether such information or speculation have any factual basis. YS Group may be exposed to a number of harmful consequences due to product contamination, including:

- injury or death of patients;
- severe decrease in the demand for, and sales of, the relevant products;
- recall or withdrawal of the relevant products;
- revocation of regulatory approvals for the relevant products or the relevant production facilities;
- damage to the brand name of YS Group's marketed product and its reputation;

- stricter and more frequent regulatory inspections of YS Group’s manufacturing facilities and products;
- inability to participate in the centralized tender process;
- exposure to lawsuits and regulatory investigation relating to the relevant products that result in liabilities, fines or penalties; and
- breach of contract with YS Group’s major customers.

***Failure to manage the normal manufacturing capacity properly may materially and adversely affect YS Group’s revenues and profitability.***

The normal manufacturing capacity is calculated based on the designed capacity of YS Group’s manufacturing facilities, after taking into account any reduction in capacity caused by, among other factors, suspension of manufacturing for renewal of GMP certification, if required, maintenance or expansion. The normal manufacturing capacity for a product directly determines the maximum amount of immunological biologics that could be produced in a given period and the volume of finished products that will be available for sale in subsequent periods.

Proper management of the normal manufacturing capacity, and in particular, minimizing the time for renewing GMP certification, if required, and maintaining GMP-compliant conditions and sufficient GMP-compliant back-up capacity in preparation for suspension of manufacturing caused by planned or unexpected events, is critical to maintaining a steady supply of products and a stable growth in YS Group’s revenues. In addition, if the normal manufacturing capacity is substantially lower than the designed capacity, idle production costs, a major component of YS Group’s cost of sales, may increase significantly.

Although YS Group has been actively taking measures to improve the management of the normal manufacturing capacity, including building new manufacturing facilities, YS Group cannot assure that such measures will be successful. The failure of such measures may significantly reduce products available for sale in subsequent periods and/or increase the idle costs, materially and adversely affecting YS Group’s revenues and profitability.

***If YS Group is unable to conduct effective sales and marketing, its business, financial condition, results of operations and prospects could be adversely affected.***

Successful sales and marketing are crucial for YS Group to increase the market penetration and sales of its marketed product and expand its market coverage. If YS Group fails to attract, motivate and retain qualified commercialization team members and maintain an effective system to manage YS Group’s commercialization team, or if its commercialization team underperforms, YS Group may experience disruptions to its business, declines in sales volume and less favorable market penetration, and fail to compete effectively. If YS Group is unable to increase or maintain the effectiveness and efficiency of its sales and marketing activities, its sales volumes, geographic coverage and business prospects could also be adversely affected. In addition, YS Group’s sales and marketing efforts depend in part on the functions of its external service providers. While YS Group implements systematic measures to manage its external service providers, such engagement may expose YS Group to certain risks, including: (1) failure to collect receivables on a timely basis or effectively; (2) failure to possess, maintain or develop the resources and capabilities required as a service provider; (3) failure to maintain or renew relevant qualifications; (4) engaging in non-compliant conducts, especially in those areas out of YS Group’s direct supervision; and (5) failure to report adverse events or side effects, or process potential recalls in a timely manner. Any of these incidents may have an adverse impact on YS Group’s business and results of operations.

***Failure to establish a complete and effective network of cold-chain logistics providers or otherwise maintain effective and comprehensive cold-chain logistics during transportation of YS Group’s vaccine products may cause great risk of damage to YS Group’s vaccine products and YS Group’s reputation and business would suffer.***

Vaccines are sensitive biological products. Some vaccines are sensitive to freezing, some to heat and others to light. Vaccine manufacturers are required to sell directly to county-level CDCs and take charge of quality control during transportation until the products are delivered to the county-level CDCs. Furthermore, the vaccines must be transported through a cold-chain within the temperature range provided by relevant

requirements. To ensure YS Group's compliance with relevant laws and regulations and maintain product quality and potency, YS Group's vaccines must be stored in good conditions through cold-chain logistics providers. In order to maintain a reliable vaccine cold chain at manufacture level before delivery to its customers, YS Group is required to, among others, establish a complete and effective network of cold-chain logistics providers to store vaccines and diluents within the approved temperature range at all sites, pack and transport vaccines to and from outreach sites according to recommended procedures, and perform regular oversight and monitor on the delivery process to YS Group's customers, or other safety, efficacy and quality issues. YS Group was involved and may in the future involve in certain administrative proceedings concerning the temperature conditions during the testing and transportation process of third parties for YS Group's marketed product, which might have had affected the testing results and resulted in negative implication on YS Group's product quality and reputation. If YS Group or third parties YS Group cooperated with fail to comply with cold-chain logistics during transportation, such as during the delivery process to customers and the inspection process, YS Group's vaccine products may be exposed to inappropriate temperatures or other improper storage conditions and subject to potency diminishment or even potency loss. In this case, all the vaccine products are subject to quality damage and may need to be destroyed. As a result, YS Group's reputation and business would suffer. YS Group may also be exposed to third-party risks with respect to the cold-chain logistics concerning its entire commercialization process, some of which are beyond YS Group's control.

***Counterfeits of YS Group's products and illegal vaccines could negatively affect its sales and its reputation and expose YS Group to liability claims.***

Certain vaccines distributed or sold may be manufactured without proper licenses or approvals, or are fraudulently mislabeled with respect to their content or manufacturers. These products are generally referred to as counterfeit vaccine products. The counterfeit vaccine product control and enforcement system, particularly in developing markets might be inadequate to discourage or eliminate the manufacturing and sale of counterfeit vaccine products imitating YS Group's products. Since counterfeit vaccine products in many cases have very similar appearances with the authentic vaccine products but are generally sold at lower prices, counterfeits of YS Group's products can quickly erode YS Group's sales volume of the relevant products. Moreover, counterfeit products may or may not have the same chemical composition as YS Group's products do, which may make them less effective than YS Group's products, entirely ineffective or more likely to cause severe adverse side effects. This could expose YS Group to negative publicity, reputational damage, fines and other administrative penalties, and may even result in litigation against YS Group. The existence and prevalence of counterfeit vaccine products, products of inferior quality and other unqualified products in recent years from time to time may reinforce the negative image in general of all pharmaceutical products manufactured in China among consumers, and may harm the reputation of companies like YS Group.

***Failure to maintain and predict inventory levels in line with demand for YS Group's marketed product could cause YS Group to lose sales or face excess inventory risks and holding costs, which could have a material adverse effect on YS Group's business, financial condition and results of operations.***

YS Group maintains an inventory level based on anticipated product demand and production schedule. However, YS Group cannot guarantee that it will be able to maintain proper inventory levels for marketed product and raw materials. Inventory levels in excess of product demand may result in inventory write-downs, expiration of products and increase in inventory holding costs. Conversely, YS Group may experience inventory shortages if YS Group underestimates demand for its products, which may result in unfilled orders and have a negative impact on its relationship with its customers. To manage its inventory level, YS Group has implemented certain measures. See "YS Group's Business — Inventory Management." However, YS Group cannot assure you that these measures will be effective and its inventory level will decrease in the future. If YS Group's inventory level increases further in the future, its financial condition and cash flow could be materially and adversely affected.

***YS Group's business depends on the use of raw materials, and a decrease in the supply or an increase in the cost of these raw materials could materially and adversely affect its business, financial condition and results of operations.***

In order to manufacture its products, YS Group must obtain sufficient quantities of high-quality raw materials at commercially acceptable prices and in a timely manner. Any disruption in production or inability of YS

Group's suppliers to produce and provide adequate quantities to meet its needs could impair YS Group's ability to operate its business on a day-to-day basis and to continue its research and development of YS Group's future product candidates. Moreover, YS Group expects its demand for such materials to increase as YS Group expands its business scale and commercialize its products, and YS Group cannot guarantee that current suppliers have the capacity to meet its demand. YS Group is also exposed to the possibility of increased costs, which YS Group may not be able to pass on to customers and as a result, lower its profitability. In addition, YS Group might need to import certain raw materials from overseas suppliers, which might subject YS Group and its overseas suppliers to compliance cost with respect to import and export regulations and relevant inspection and quarantine requirements. In addition, although YS Group has implemented quality inspection procedures on such materials before they are used in its manufacturing processes and required its suppliers to maintain high quality standards, YS Group cannot guarantee that it will be able to secure sufficient quantities of raw materials at high quality standards, nor detect all quality issues in the supplies YS Group use. YS Group cannot assure you that these third parties or itself will be able to maintain and renew all filings, licenses, permits and approvals necessary for their operations, supply of raw materials or comply with all applicable laws and regulations. Failure to do so by them may lead to interruption in their business operations, which in turn may result in shortage of the supplies to YS Group. If YS Group is unable to do so and the quality of its products suffer as a result, YS Group may have to delay market supply, clinical trials and regulatory filings, recall its products, be subject to product liability claims, fail to comply with continuing regulatory requirements and incur significant costs to rectify such issue, which may have a material and adverse effect on YS Group's business, financial condition and results of operations.

***YS Group deals with potentially harmful biological materials and other hazardous materials that may cause environmental contamination or injury to others.***

YS Group's research and development programs, clinical trials and manufacturing operations involve the controlled use of potentially harmful biological materials and other hazardous materials, e.g. pathogenic microbe. YS Group is required to obtain and timely renew relevant approvals, permits and filings in the course of its development and manufacturing activities while it might fail to do so. In particular, the risk of accidental contamination to the environment or injury to YS Group's employees or others from the use, manufacture, storage, handling or disposal of these materials may not be completely eliminated. In the event of contamination or injury, YS Group could be held liable for any resulting damages, which could exceed its resources or any applicable insurance coverage they may have. Furthermore, governmental agencies could initiate investigations against YS Group, which may result in fines, sanctions, revocations of operating permits, suspension of their operations, closure of YS Group's facilities or other penalties. YS Group's reputation may be harmed as well. Furthermore, laws, rules or regulations regarding handling of harmful biological materials and other hazardous materials, or more stringent environmental regulations that may be adopted in the future, may mandate additional protective and other measures against potential contamination or injury caused by these materials, compliance with which could be costly, and YS Group's profitability could be materially reduced as a result.

**Risks related to YS Group's Financial Position and Working Capital Need**

***YS Group has incurred significant losses since its inception. YS Group might incur losses or fail to generate sufficient revenue to achieve satisfactory profitability in the future.***

YS Group has incurred substantial expenses and expect to continue to incur significant expenses related to clinical trials and preclinical studies in the future. As of the date of this proxy statement/prospectus, YS Group had one marketed product, YSJA™ rabies vaccine, and YS Group had begun to recognize revenue relating to its sales from October 2020. YS Group incurred net loss of RMB191.8 million, RMB106.0 million (\$16.7 million) and RMB11.1 million (\$1.6 million) for the fiscal years ended March 31, 2021 and 2022 and the six months ended September 30, 2022, respectively. YS Group's future financial position will depend, in part, on the sale of its marketed product, the rate of its future expenditures and its ability to obtain funding through equity or debt financings, strategic collaborations or additional grants. YS Group's future revenue and profitability will also depend upon the size of any markets in which its product and product candidates have received approval, the commercialization of its product candidates, its manufacturing capabilities, its ability to achieve sufficient market acceptance, secure procurement from CDCs in China and other factors.

YS Group expects to continue to incur significant expenses and operating losses in the foreseeable future. YS Group anticipates that its expenses will increase if and as it:

- experiences the sales growth of YSJA™ rabies vaccine;
- continues to advance the clinical trials and preclinical studies of YS Group's current pipelines;
- initiates preclinical, clinical or other studies for new product candidates;
- manufactures materials for clinical trials and for commercial sale;
- seeks regulatory approvals for YS Group's product candidates that successfully complete clinical trials;
- develops and expands YS Group's commercialization team to promote the sale of its marketed product and commercialize any products for which YS Group may obtain marketing approval;
- acquires or in-licenses other product candidates and technologies;
- maintains, protects and expands YS Group's intellectual property portfolio;
- attracts and retains skilled personnel; and
- creates additional infrastructure to support YS Group's operations as a public company and its product development and planned future commercialization efforts.

YS Group's ability to become and remain profitable depends on its ability to generate sufficient revenue. Even if YS Group is able to generate revenue from the sale of its products, YS Group may not become profitable and may need to obtain additional funding to continue operations. If YS Group fails to become profitable or are unable to sustain profitability on a continuing basis, YS Group may be unable to continue its operations at planned levels and be forced to reduce its operations. YS Group's failure to become and remain profitable would decrease the value of YS Group and could impair its ability to raise capital, expand its business or continue its operations. Failure to become and remain profitable may adversely affect the market price of YS Group's Shares. A decline in the value of YS Group could also cause you to lose all or part of your investment.

***YS Group's financial prospects depend on the sale of its marketed product, and the successful development and approval of its clinical-stage and preclinical stage product candidates.***

YS Group's ability to generate revenue and become profitable in the future depends upon its ability to achieve sales growth of YSJA™ rabies vaccine and to successfully complete the development of, obtain the necessary regulatory approvals for, and commercialize its product candidates. YS Group expects sales of YSJA™ rabies vaccine to generate substantially all of its revenue in the near term. YS Group's ability to successfully commercialize YSJA™ rabies vaccine and expand its sales will depend on, among other things, YS Group's ability to maintain proper manufacturing facilities, achieve effective sales and marketing, maintain competitive attractiveness, secure widespread acceptance of this product, maintain compliance with ongoing regulatory requirement, properly price and obtain coverage and adequate reimbursement of this product by governmental authorities, private health insurers and other third-party payors. If YSJA™ rabies vaccine fails to achieve successful sales and further sales expansion, it could have a material adverse effect on YS Group's business, financial condition and results of operations.

YS Group is also developing multiple product candidates for infectious diseases and cancer. YS Group has invested a significant portion of its efforts and financial resources in the development of its product candidates, and YS Group expects to continue to incur substantial and increasing expenditures through the projected commercialization of these product candidates. None of these product candidates has been approved for marketing in China or any other jurisdiction and may never receive such approval. YS Group's ability to achieve revenue and profitability is dependent on its ability to expand the sales of YSJA™ rabies vaccine and complete the development of product candidates, obtain necessary regulatory approvals, and have its products manufactured and successfully marketed.

Moreover, because YS Group has limited financial and managerial resources, YS Group focus its product pipelines on research and development programs and product candidates that YS Group identifies for specific indications. As a result, YS Group may forego or delay pursuit of opportunities with other product candidates or for other indications that later prove to have greater commercial potential. YS Group's resource allocation



decisions may cause YS Group to fail to capitalize on viable commercial product or profitable market opportunities. YS Group's spending on current and future research and development programs and product candidates for specific indications may not yield any commercially viable products. If YS Group does not accurately evaluate the commercial potential or target market for a particular product candidate, YS Group may relinquish valuable rights to that product candidate through collaboration, licensing or other royalty arrangements in cases in which it would have been more advantageous for YS Group to retain sole development and commercialization rights.

***YS Group may need to obtain substantial additional financing to fund its operations, and a failure to obtain necessary capital when needed would force YS Group to delay, limit, reduce or terminate its product development or commercialization efforts.***

In the two fiscal years ended March 31, 2022 and the six months ended September 30, 2022, YS Group primarily funded its operations through investments from investors, bank borrowings and cash generated from sales of its marketed rabies vaccines and new product launches for the next 5 years. YS Group believes that it will need to spend substantial resources for the commercialization and sales of its marketed product and the research and development and commercialization of its product candidates. YS Group's future capital requirements depend on many factors, including:

- the commercialization and sale of YS Group's marketed product and the cost and timing of future commercialization activities for its marketed product and its product candidates, if any of YS Group's product candidates are approved for marketing, including product manufacturing, marketing, sales and distribution costs;
- the commercialization and sales of YS Group's product candidates at discovery and clinical stage;
- the progress, results and costs of the clinical, preclinical and other studies of YS Group's product candidates;
- the timing, receipt, and amount of sales of, or royalties or milestone payments on, YS Group's future products, if any;
- discovery of new product candidates;
- the timing of, and the costs involved in, obtaining regulatory approvals for YS Group's product candidates;
- the costs involved in preparing, filing, prosecuting patent applications, maintaining, defending and enforcing YS Group's intellectual property rights, including litigation costs and the outcome of such litigation; and
- the extent to which YS Group acquires or in-license other products or technologies.

YS Group plans to use the outstanding cash after consummation of the Business Combination, together with bank borrowings and cash from operating activities, to primarily fund YS Group's future operations. However, if the commercialization of YS Group's marketed product and product candidates is delayed or terminated, or if expenses increase, YS Group may need to obtain additional financing to fund its operations. Additional funds may not be available when YS Group needs them, on terms that are acceptable to YS Group, or at all. YS Group's ability to raise funds will depend on financial, economic and market conditions and other factors, many of which are beyond its control. If adequate funds are not available to YS Group on a timely basis, YS Group may be required to delay, limit, reduce or terminate preclinical studies, clinical trials or other research and development activities or commercialization for one or more of its product candidates, and in turn will adversely affect YS Group's business prospects.

***YS Group had net cash outflow from operating activities in the two fiscal years ended March 31, 2022 and the six months ended September 30, 2022 and may continue to experience such cash outflow for the foreseeable future.***

YS Group had net cash used in operating activities of RMB246.6 million, RMB173.5 million (\$27.3 million) and RMB107.4 million (\$15.1 million) for the fiscal years ended March 31, 2021 and 2022 and the six months ended September 30, 2022, respectively, and YS Group may not be able to achieve or sustain operating cash inflows for the foreseeable future. Although YS Group believes it has sufficient working capital to fund its operations, if in any case YS Group is unable to maintain adequate liquidity for operating activities, YS Group may not be able to fund its research and development and commercialization activities and to meet its

capital expenditure requirements, which may have a material adverse effect on YS Group's business prospects, financial condition and results of operations.

***YS Group incurred net liabilities in the two fiscal years ended March 31, 2022 and six months ended September 30, 2022, and may continue to have net liabilities in the foreseeable future, which can expose YS Group to liquidity risk.***

YS Group had net liabilities (or total deficit) of RMB1,167.2 million, RMB1,441.8 million (\$227.1 million) and RMB1,548.4 million (\$218.1 million) as of March 31, 2021 and 2022 and September 30, 2022, respectively. The increase in YS Group's total deficit was primarily attributable to the increase in the fair value of its convertible redeemable preferred shares and convertible notes which YS Group recognized as liabilities.

Net liabilities (total deficit) position can expose YS Group to the risk of shortfalls in liquidity. This in turn would require YS Group to seek adequate financing from sources such as external debt, which may not be available on terms favorable or commercially reasonable to YS Group or at all. Any difficulty or failure to meet YS Group's liquidity needs as and when needed can have a material adverse effect on its business and prospects.

A large balance of indebtedness, whether from banks or related parties, may require that YS Group devotes its financial resources to servicing such debt rather than funding its operating activities and investments in research and development, which constrains YS Group's capital flexibility and may in turn adversely affect the development timetable of its product candidates. It may also be a challenge for YS Group to pay its interest and principal repayments in a timely manner or at all, which could trigger cross-defaults with other debt, as applicable, as well as limit YS Group's ability to obtain further debt financing. Given YS Group's historical reliance on external equity and debt financing, such developments could have a material adverse effect on its business, financial condition and results of operations. While the net liabilities position will be improved with the conversion of the convertible redeemable preferred shares upon the consummation of the Business Combination, YS Group cannot guarantee that it will not incur net liabilities in the future, in which case YS Group's liquidity and its ability to raise funds, obtain bank loans, pay debts when they become due and declare and pay dividends will be materially and adversely affected.

***If YS Group determines its intangible assets to be impaired, YS Group's results of operations and financial condition may be adversely affected.***

As of March 31, 2021 and 2022 and September 30, 2022, YS Group had intangible assets of RMB83.8 million, RMB80.7 million (\$12.7 million) and RMB81.3 million (\$11.5 million), respectively, which primarily consisted of patents relating to YS Group's PIKA adjuvant technology and other licenses, certificates and intellectual properties relating to YS Group's business operations. YS Group's determination on whether intangible assets are impaired requires an estimation on recoverable amount of the intangible assets, which is based on a number of assumptions made by YS Group's management. If any of these assumptions does not materialize, or if the performance of YS Group's business is not consistent with such assumptions, the carrying amount of the intangible assets may exceed its recoverable amount, and YS Group's intangible assets may be impaired. As a result, YS Group may be required to have a significant write-off of its intangible assets and record a significant impairment loss, which would have a material adverse effect on YS Group's business, results of operations and financial condition.

***YS Group is subject to credit risks arising from some customers. If YS Group experiences delays in collecting or if YS Group is unable to collect trade receivables from customers, its results of operations and financial condition could be adversely affected.***

YS Group commenced the sale of YSJA™ rabies vaccine in October 2020. In line with market practice, YS Group typically grants its customers a credit period of four months. As of March 31, 2021 and 2022 and September 30, 2022, YS Group had trade receivables of RMB214.5 million, RMB308.6 million (\$48.6 million) and RMB468.4 million (\$66.0 million), respectively. As of September 30, 2022, YS Group's trade receivables primarily represented amounts due from county-level CDCs attributable to the sales of YSJA™ rabies vaccines. As a result, YS Group may be exposed to credit risks. YS Group recorded allowance for impairment of trade receivables of RMB8.5 million, RMB13.6 million (\$2.1 million) and RMB20.1 million (\$2.8 million) as of March 31, 2021 and 2022 and September 30, 2022, respectively.

YS Group cannot assure you that its customers could settle trade receivables in a timely manner, or at all, or that YS Group can properly assess and respond in a timely manner to changes in their credit profile. If YS Group's customers' cash flows, working capital, financial condition or results of operations deteriorate, they may be unable, or they may otherwise be unwilling, to pay trade receivables owed to YS Group promptly or at all. YS Group may also be involved in litigations and disputes with its customers related to such credit risks. Any substantial defaults or delays could materially and adversely affect YS Group's cash flows, and YS Group could be required to terminate its relationships with its customers in a manner that may adversely affect YS Group's business, results of operations and financial condition.

***YS Group has incurred and may continue to incur substantial share-based payment expenses, which may have a material and adverse effect on YS Group's results of operations and financial condition.***

YS Group has adopted the 2020 Share Incentive Plan and granted certain awards to its directors, employees and consultants. YS Group believes the grant of share-based compensation is important to its ability to attract, retain and motivate its management team and qualified employees. Upon consummation of the Business Combination, the YS Biopharma will assume such share incentive plan and the outstanding awards granted by YS Group then. As of the date of this proxy statement/prospectus, there are 6,656,582 shares of the YS Biopharma reserved for its share incentive plans. YS Biopharma will reserve equivalent number of post-Closing ordinary shares to reflect the Company's ESOP Arrangement.

YS Group recorded share-based payment expenses of RMB76.8 million, RMB7.8 million (\$1.2 million) and RMB(85,316) (\$(12,017)) for the fiscal years ended March 31, 2021 and 2022 and the six months ended September 30, 2022, respectively. YS Group expects to further incur share-based payment expenses in the future as a result of any further grant or such Business Combination, which will also dilute existing shareholders' shareholding.

***Restrictions imposed by YS Group's outstanding indebtedness and any future indebtedness may limit YS Group's ability to operate its business and to finance its future operations or capital needs.***

In March 2022, YS Group completed a \$40 million royalty-based 4.5-year long-term debt transaction with R-Bridge Investment Holdings Pte. Ltd. The terms of the loan facility limit YS Group's ability to, among other things, incur additional indebtedness, incur liens on YS Group's assets, engage in consolidations, mergers, liquidations, dissolutions, sell or otherwise dispose of YS Group's assets, acquire other businesses, make loans, capital contributions, or other investments, or enter into any other transactions outside of the ordinary course of business. In addition, YS Group is obliged to pay shall pay royalties based upon YS Group's annual Net Sales (as defined in the royalty deed dated March 16, 2022 entered into between HK Yisheng and R-Bridge Healthcare Fund, LP) by multiplying the applicable royalty rate by the corresponding amount incremental Net Sales for that financial year. The terms of YS Group's loan facilities and royalty obligations restrict YS Group's current and future operations and could adversely affect YS Group's ability to finance its future operations or capital needs or take advantage of financing opportunities, mergers, acquisitions, investments, and other corporate opportunities that may be beneficial to YS Group's business. In addition, complying with these covenants may make it more difficult for YS Group to successfully execute its business strategy and compete against companies which are not subject to such restrictions.

#### **Risks related to YS Group's Intellectual Property**

***The issuance, scope, validity, enforceability and commercial value of YS Group's patent rights are highly uncertain, and there can be no assurance that any of YS Group's technology, marketed product or product candidates will be protectable or remain protected by valid and enforceable patents. If YS Group is unable to obtain and maintain patent protection for its marketed product and product candidates, or if the scope of such patent protection obtained is not sufficiently broad, third parties may compete directly against YS Group.***

YS Group's success depends, in part, on its ability to protect its marketed product and product candidates from competition by obtaining, maintaining and enforcing its intellectual property rights, including patent rights. YS Group seeks to protect its marketed product and product candidates and technology that YS Group considers commercially important by filing PRC and international patent applications. YS Group does not currently own a valid composition of matter patent for its marketed product, YSJA™ rabies vaccine, and rely

on YS Group's know-how, proprietary techniques and patents in relation to its manufacturing process, together with established safety and efficacy profile as well as reputation, to protect its marketed product. If YS Group is unable to obtain or maintain patent or other statutory protection with respect to any of its marketed product and product candidates and the technology YS Group develops, or if the scope of such patent or other statutory protection obtained is not sufficiently broad, third parties may compete directly against YS Group, and YS Group's business, financial condition, results of operations, and prospects could be materially and adversely affected.

The patent prosecution process is expensive, time-consuming and complex, and YS Group may not be able to file, prosecute, maintain or license all necessary or desirable patent applications at a reasonable cost or in a timely manner. YS Group cannot assure you that its patent applications will result in the issuance of any patents that effectively protect its product candidates. The claim scope of a patent application can be significantly reduced before the patent is issued, and it can be reinterpreted after issuance. The scope of protection for issued patents may also vary across different jurisdictions. Changes in either the patent laws or interpretation of the patent laws in various jurisdictions may diminish the value of YS Group's patents or narrow the scope of its patent protection. Patent may not be issued in a form that will provide YS Group with any meaningful protection, prevent competitors or other third parties from competing with YS Group, or otherwise provide YS Group with any competitive advantage. In addition, the patent position of biotechnology and pharmaceutical companies generally is highly uncertain, involves complex legal and factual questions, and has been the subject of considerable litigation in recent years. Third parties may dispute that YS Group's product candidates are not validly protected by the underlying patents relating to PIKA adjuvant due to the uncertainties as to the interpretation of the scope and other parameters relating to such patents, and as such, they may attempt to manufacture and commercialize products similar to YS Group's product candidates without infringing upon any valid patents YS Group holds in the relevant jurisdictions. YS Group cannot assure you that it will successfully defend the merits and scope of its patent protection and that YS Group may be forced to tolerate and compete with such similar products. Consequently, the issuance, scope, validity, enforceability and commercial value of YS Group's patent rights are highly uncertain, and YS Group cannot assure you that any of its technology, marketed product or product candidates will be protectable or remain protected by valid and enforceable patents.

The issuance of a patent is not conclusive as to its inventorship, scope, validity or enforceability, and YS Group's patents may be challenged in the courts or patent offices in China, Singapore, the United States and other countries or jurisdictions. An adverse determination in any such submission, proceeding or litigation could reduce the scope of, or invalidate, YS Group's owned patent rights, allow third parties to commercialize its technology, marketed product or product candidates and compete directly with YS Group without payment to YS Group. Such proceedings also may result in substantial costs and require significant time from YS Group's scientists and management. YS Group's competitors or other third parties may be able to circumvent YS Group's owned patents by developing similar or alternative technologies or products in a non-infringing manner. Furthermore, the terms of patents are finite. See the section entitled "— If YS Group does not obtain patent term extension and data exclusivity for any of its product candidates it may develop, YS Group's business may be materially harmed."

As a result, YS Group's owned patents and patent applications may not provide YS Group with sufficient rights to exclude others from commercializing products similar or identical to ours. Moreover, some of YS Group's patents and patent applications may in the future be co-owned with third parties. If YS Group is unable to obtain an exclusive license to any such third-party co-owners' interest in such patents or patent applications, such co-owners may be able to license their rights to other third parties, including YS Group's competitors, and YS Group's competitors could market competing products and technology. In addition, YS Group may need the cooperation of any such co-owners of its patents in order to enforce such patents against third parties, and such cooperation may not be provided to YS Group. Any of the foregoing could have a material adverse effect on YS Group's competitive position, business, financial condition, results of operations and prospects.

***Obtaining and maintaining YS Group's patent protection depend on compliance with various procedures, document submission, fee payment, and other requirements imposed by governmental patent agencies, and YS Group's patent protection could be reduced or eliminated for noncompliance with these requirements.***

Many government patent agencies require compliance with several procedural, documentary, fee payment, and other similar provisions during the patent application and transfer process. YS Group is also dependent

on its agents to take the necessary action to comply with these requirements. YS Group cannot assure that it or its agents will comply with these requirements in a timely manner. YS Group did not experience any material failure to comply with these requirements in the two fiscal years ended March 31, 2022 and the six months ended September 30, 2022 that has resulted in any material adverse effect to the scope or validity of YS Group's owned patents. If YS Group fails to comply with these requirements, it may be subject to additional late payment fines or injunctions. There are situations, however, in which non-compliance can result in abandonment or lapse of the patent or patent application, resulting in a partial or complete loss of patent rights in the relevant jurisdiction. In such an event, potential competitors might be able to enter the market with similar or identical products or technology, which could have a material adverse effect on YS Group's business, financial condition, results of operations, and prospects.

***If YS Group does not obtain patent term extension and data exclusivity for any of its product candidates it may develop, YS Group's business may be materially harmed.***

The Patent Law of China, amended in October 2020 and effective on June 1, 2021, provides that, upon the requests of the patentee, the patent administrative authorities shall grant a limited patent term extension to the patent relating to a new drug that has been approved in China, as compensation for patent term lost during the NMPA regulatory review process of such new drug. The compensation period shall not exceed five years, and the total validity period of patent rights for such approved new drug shall not exceed 14 years after the market approval of such drug. During the regulatory review process of a new drug, should any disputes arise due to the patent relating to the new drug, for which approval is being sought, whether the patent will be infringed by the proposed drug may be answered by a people's court upon the requests of the relevant parties before the final approval is provided. The NMPA may make a decision whether to suspend the approval review process of the proposed drug based on the judgment of the people's court. On July 4, 2021, the NMPA and the China National Intellectual Property Administration issued Implementing Measures for the Early Settlement Mechanism for Drug Patent Disputes (for Trial Implementation). On the same day, the Supreme People's Court of the PRC issued Provisions of Supreme People's Court on Several Issues Concerning the Application of Law in the Hearing of Civil Cases Involving Disputes over Patent Rights Relating to Drugs under Application for Registration, which became effective on July 5, 2021. However, relevant regulations are implemented for a relatively short period of time and therefore the enforcement of laws and regulations regarding the patent linkage system remain uncertain in China. In addition, Chinese regulators have set forth a framework for integrating data exclusivity into the Chinese regulatory regime, but no specific regulations have been issued. These factors result in weaker protection for YS Group against generic competition in China than could be available to YS Group in the United States. If YS Group is unable to obtain patent term extension or term of any such extension is less than it requests, YS Group's competitors may obtain approval of competing products following YS Group's patent expiration, and YS Group's business, financial condition, results of operations, and prospects could be materially harmed.

***Developments in patent law could have a negative impact on YS Group's business.***

Changes in either the patent laws or interpretation of the patent laws in China, the United States and other government authorities could increase the uncertainties and costs surrounding the prosecution of patent applications and the enforcement or defense of issued patents. For example, Leahy-Smith America Invents Act (the "America Invents Act"), which was signed into law in September 2011, includes a number of significant changes to U.S. patent law. These changes include a transition from a "first-to-invent" system to a "first inventor-to-file" system as of March 2013, changes to the way issued patents are challenged, and changes to the way patent applications are disputed during the examination process. These include allowing third party submission of prior art to the United States Patent and Trademark Office (the "USPTO") during patent prosecution and additional procedures to attack the validity of a patent by the USPTO administered post grant proceedings, including post grant review, inter parties review, and derivation proceedings. The PRC laws on the protection of intellectual property rights of drugs are also evolving. The Patent Law of the PRC and the Implementation Rules of the Patent Law of the PRC are applicable to drugs protected by patents. On October 17, 2020, the Standing Committee of the National People's Congress of the PRC passed the decision to amend the Patent Law of the PRC. The amended patent law came into effect on June 1, 2021. The amended Patent Law provides, among other things, that (1) in case an invention patent is only granted after four years or more from its filing date and three years or more after a request for substantive examination was filed, the patentee can request for an extension of patent term for any unreasonable delay; and (2) the patent term

extension will also be available for pharmaceutical-related patents, similar to a supplementary protection certificate in other jurisdictions, to compensate the time spent in obtaining marketing authorization for a drug. The maximum extension for drug-related patents shall be five years with a total effective patent term not exceeding 14 years after the marketing authorization of such drug is obtained. It is, however, not entirely clear what procedures must be followed in order to apply for such extension.

Changes to patent law may affect YS Group's ability to obtain patents, and if obtained, to enforce or defend them. Accordingly, it is not entirely clear what, if any, impact the changes to patent law will have on the cost of prosecuting YS Group's patent applications and its ability to obtain patents based on its discoveries and to enforce or defend any patents that may issue from its patent applications, all of which could have a material adverse effect on YS Group's business, financial condition, results of operations and prospects.

***If YS Group is unable to maintain the confidentiality of YS Group's trade secrets, its business and competitive position may be harmed.***

In addition to the protection afforded by issued patents and pending patent applications, YS Group relies upon unpatented trade secret protection, unpatented know-how and continuing technological innovation to develop and maintain YS Group's competitive position. However, trade secrets and know-how can be difficult to protect. YS Group also seeks to protect its proprietary technology and processes, in part, by entering into confidentiality agreements with parties that have access to them, such as its partners, collaborators, scientific advisors, employees, consultants and other third parties, and invention assignment agreements with its consultants and employees. YS Group cannot guarantee that it has entered into such agreements with each party that may have or have had access to its trade secrets or proprietary technology and processes. YS Group may not be able to prevent the unauthorized disclosure or use of its technical know-how or other trade secrets by the parties to these agreements, however, despite the existence of confidentiality agreements and other contractual restrictions. If any of the partners, collaborators, scientific advisors, employees and consultants who are parties to these agreements breaches or violates the terms of any of these agreements or otherwise discloses YS Group's proprietary information, YS Group may not have adequate remedies for any such breach or violation, and YS Group could lose its trade secrets as a result. Enforcing a claim that a third party illegally disclosed or misappropriated YS Group's trade secrets, including through intellectual property litigations or other proceedings, is difficult, expensive and time-consuming, and the outcome is unpredictable. In addition, courts in China and other jurisdictions inside and outside the United States may be less prepared, less willing or unwilling to protect trade secrets. YS Group's trade secrets could otherwise become known or be independently discovered by its competitors or other third parties.

For example, competitors could purchase YS Group's marketed product and product candidates, attempt to replicate some or all of the competitive advantages YS Group derives from its development efforts, and design around YS Group's intellectual property protecting such technology or develop their own competitive technologies that fall outside of YS Group's intellectual property rights. If any of YS Group's trade secrets were to be disclosed or independently developed by a competitor, YS Group would have no right to prevent them, or others to whom they communicate it, from using that technology or information to compete against YS Group, which may have a material adverse effect on YS Group's business, prospects, financial condition and results of operations.

***YS Group may be subject to claims challenging the inventorship of its patents and ownership of other intellectual property.***

Although YS Group is not currently experiencing any claims challenging the inventorship of its patents or ownership of its other intellectual property, YS Group may be subject to claims that former employees, collaborators or other third parties have an interest in YS Group's patents or other intellectual property as inventors or co-inventors. Litigation may be necessary to defend against these and other claims challenging inventorship. If YS Group fails to defend any such claims, in addition to paying monetary damages, it may lose rights such as exclusive ownership of, or right to use, YS Group's patent rights or other intellectual property. Such an outcome could have a material adverse effect on YS Group's business. Even if YS Group is successful in defending against such claims, litigation could result in substantial costs and be a distraction to management and other employees.

***YS Group may be subject to claims that it or its employees, consultants or advisors have wrongfully used or disclosed alleged trade secrets of competitors or their current or former employers or are in breach of non-competition or non-solicitation agreements with competitors or other third parties.***

YS Group could in the future be subject to claims that it or its employees, consultants or advisors have inadvertently or otherwise used or disclosed alleged trade secrets or other proprietary information of current or former employers, competitors or other third parties. Many of YS Group's employees, consultants and advisors are currently or were previously employed at universities or other biotechnology or pharmaceutical companies, including YS Group's competitors or potential competitors. Although YS Group tries to ensure that its employees and consultants do not improperly use the intellectual property, proprietary information, know-how or trade secrets of others in their work for YS Group, YS Group may be subject to claims that YS Group or these individuals have breached the terms of his or her non-competition or non-solicitation agreement, or that YS Group or these individuals have, inadvertently or otherwise, used or disclosed the alleged trade secrets or other proprietary information of a current or former employer, competitor or other third parties.

Litigation may be necessary to defend against the above-described claims. Even if YS Group is successful in defending against these claims, litigation could result in substantial costs and could be a distraction to management and research personnel. If YS Group's defenses to these claims fail, in addition to requiring YS Group to pay monetary damages, a court could prohibit YS Group from using technologies or features that are essential to its product candidates, if such technologies or features are found to incorporate or be derived from the trade secrets or other proprietary information of the former employers or competitors. An inability to incorporate such technologies or features would have a material adverse effect on YS Group's business and may prevent YS Group from successfully commercializing its product candidates. In addition, YS Group may lose valuable intellectual property rights or personnel as a result of such claims. Moreover, any such litigation or threat of such litigation may adversely affect YS Group's ability to hire employees or contract with independent sales representatives. A loss of key personnel or their work product could hamper or prevent YS Group's ability to commercialize its product and product candidates, which would have a material adverse effect on its business, results of operations and financial condition.

In addition, while it is YS Group's policy to require its employees and contractors who may be involved in the conception or development of intellectual property to execute agreements assigning such intellectual property to YS Group, YS Group may be unsuccessful in executing such an agreement with each party who, in fact, conceives or develops intellectual property that YS Group regards as its own. The assignment of intellectual property rights may not be self-executing, or the assignment agreements may be breached, and YS Group may be forced to bring claims against third parties, or defend claims that they may bring against YS Group, to determine the ownership of what YS Group regards as its intellectual property. Such claims could have a material adverse effect on YS Group's business, financial condition, results of operations and prospects.

***YS Group may not be able to protect and effectively enforce its intellectual property rights including patents.***

YS Group may not be able to identify the infringement of its intellectual property rights including patents at an early stage and may forfeit the best opportunity to enforce the protection of such intellectual property rights. Even if YS Group is able to enforce intellectual property rights in a timely manner, the legal system in certain jurisdictions including China may have generally provided less protection for intellectual property rights than certain other legal systems, such as in the United States. Policing unauthorized use of proprietary technology is difficult and expensive, and YS Group might need to resort to litigation to enforce or defend patents issued to them or to determine the enforceability, scope and validity of its proprietary rights or those of others. The experience and capabilities of courts in different and other jurisdictions in handling intellectual property litigation varies, and outcomes are unpredictable. Furthermore, such litigation may require significant expenditures of cash and management efforts and could harm YS Group's business, financial condition and results of operations. As a result, YS Group may not be able to enforce its intellectual property right and effectively stop infringe, and an adverse determination in any such litigation could materially impair its intellectual property rights and may harm its business, prospects and reputation.

***YS Group may not be able to protect its intellectual property rights throughout the world.***

YS Group owns, or have filed application for, patents for its product candidates in over 30 countries and regions. Filing, prosecuting, maintaining and defending patents on YS Group's product candidates in all

countries and regions throughout the world could be prohibitively expensive for YS Group. Competitors may use YS Group's technologies in jurisdictions where YS Group has not obtained patent protection to develop their own product candidates and may also export otherwise infringing products to jurisdictions where YS Group has patent protection, but where enforcement rights are not strong. These products may compete with YS Group's marketed product and product candidates and YS Group's patent rights or other intellectual property rights may not be effective or adequate to prevent them from competing.

The legal systems of some countries do not favor the enforcement of patents, trade secrets and other intellectual property, particularly those relating to biopharmaceutical products, which could make it difficult in those jurisdictions for YS Group to stop the infringement or misappropriation of its patents or other intellectual property rights, or the marketing of competing products in violation of its proprietary rights. Proceedings to enforce YS Group's intellectual property and proprietary rights in foreign jurisdictions could result in substantial costs and divert YS Group's efforts and attention from other aspects of its business, could put YS Group's patents at risk of being invalidated or interpreted narrowly, could put YS Group's patent applications at risk of not issuing, and could provoke third parties to assert claims against YS Group. YS Group may not prevail in any lawsuits that YS Group initiates, and the damages or other remedies awarded, if any, may not be commercially meaningful. Accordingly, YS Group's efforts to enforce its intellectual property and proprietary rights around the world may be inadequate to obtain a significant commercial advantage from the intellectual property that YS Group develops or licenses.

Furthermore, many countries have compulsory licensing laws under which a patent owner may be compelled to grant licenses to third parties. In addition, many countries limit the enforceability of patents against government agencies or government contractors. In these countries, the patent owner may have limited remedies, which could materially diminish the value of such patent. If YS Group is forced to grant a license to third parties with respect to any patents relevant to its business, its competitive position may be impaired, and its business, financial condition, results of operations and prospects may be adversely affected.

***YS Group may become involved in lawsuits to protect or enforce its intellectual property, which could be expensive, time-consuming and unsuccessful. YS Group's patent rights relating to its product candidates could be found invalid or unenforceable if challenged in court or before other authorities.***

Competitors may infringe YS Group's patent rights or misappropriate or otherwise violate YS Group's intellectual property rights. To counter infringement or unauthorized use, litigation may be necessary in the future to enforce or defend YS Group's intellectual property rights, to protect YS Group's trade secrets or to determine the validity and scope of YS Group's own intellectual property rights or the proprietary rights of others. This can be expensive and time consuming. Any claims that YS Group asserts against perceived infringers could also provoke these parties to assert counterclaims against YS Group alleging that YS Group infringes their intellectual property rights. Many of YS Group's current and potential competitors have the ability to dedicate substantially greater resources to enforce and/or defend their intellectual property rights than YS Group can. YS Group cannot assure you that it will be able to prevent third parties from infringing upon or misappropriating its intellectual property in the future. Litigation could result in substantial costs and diversion of management resources, which could harm YS Group's business and financial results.

In addition, in an infringement proceeding, a court may refuse to stop the other party from using the technology at issue on the grounds that YS Group's owned patents do not cover such third-party technology. An adverse result in any litigation proceeding could put YS Group's patent, as well as any patents that may issue in the future from YS Group's pending patent applications, at risk of being invalidated, held unenforceable or interpreted narrowly. Furthermore, because of the substantial amount of discovery required in connection with intellectual property litigation, there is a risk that some of YS Group's confidential information could be compromised by disclosure during this type of litigation. Moreover, such third parties could counterclaim that YS Group infringes, misappropriates or otherwise violates their intellectual property or that a patent YS Group has asserted against them is invalid or unenforceable. In patent litigation, defendant counterclaims challenging the validity, enforceability or scope of asserted patents are commonplace and there are numerous grounds upon which a third party can assert invalidity or unenforceability of a patent.

Furthermore, third parties may initiate legal proceedings before administrative bodies in China and/or other jurisdictions, even outside the context of litigation, against YS Group with respect to its owned intellectual property to assert challenges to such intellectual property rights. Such mechanisms include re-examination,



inter parties review, post-grant review, interference proceedings, derivation proceedings and equivalent proceedings in foreign jurisdictions (e.g., opposition proceedings). Such proceedings could result in revocation, cancellation or amendment to YS Group's patents in such a way that they no longer cover and protect its product candidates. YS Group was not involved in any pending proceeding where a third party attempted to challenge the validity, enforceability or scope of its intellectual property rights as of the date of this proxy statement/prospectus. YS Group cannot assure you that it will always prevail in any such proceeding as its outcome is generally unpredictable. The cost to YS Group of any patent litigation or similar proceeding could be substantial, and it may consume significant management and other personnel time. YS Group does not maintain insurance to cover intellectual property infringement, misappropriation or violation.

An adverse result in any litigation or other intellectual property proceeding could put one or more of YS Group's patents at risk of being invalidated, rendered unenforceable or interpreted narrowly. If a defendant were to prevail on a legal assertion of invalidity or unenforceability of YS Group's patents covering one or more of its product candidates, YS Group would lose at least part, and perhaps all, of the patent protection covering such product candidates. Competing products may also be sold in other countries in which YS Group's patent coverage might not exist or be as strong. If YS Group loses a foreign patent lawsuit, alleging its infringement of a competitor's patents, YS Group could be prevented from marketing its products in one or more foreign countries. Furthermore, because of the substantial amount of discovery required in connection with intellectual property litigation, there is a risk that some of YS Group's confidential information could be compromised by disclosure during this type of litigation.

Any of these outcomes would have a materially adverse effect on YS Group's business, financial condition, results of operations and prospects.

***Intellectual property litigation and proceedings could cause YS Group to spend substantial resources and distract YS Group's personnel from its normal responsibilities.***

Third parties who bring successful claims against YS Group for infringement of their intellectual property rights may obtain injunctive or other equitable relief, which could prevent YS Group from developing and commercializing one or more of its marketed product and product candidates. Defense of these claims, regardless of their merits, would involve substantial litigation expense and would be a substantial diversion of employee resources from YS Group's business. In the event of a successful claim of infringement or misappropriation against YS Group, YS Group may have to pay substantial damages, including treble damages and attorneys' fees in the case of willful infringement, obtain one or more licenses from third parties, pay royalties or redesign its infringing marketed product and product candidates, which may be impossible or require substantial time and monetary expenditure. In the event of an adverse result in any such litigation, or even in the absence of litigation, YS Group may need to obtain licenses from third parties to advance its research or allow commercialization of its marketed product and product candidates. YS Group cannot predict whether any required license would be available at all or whether it would be available on commercially reasonable terms, and YS Group may fail to obtain any of these licenses on commercially reasonable terms, if at all. In the event that YS Group is unable to obtain such a license, YS Group would be unable to further develop and commercialize one or more of its marketed product and product candidates, which could harm YS Group's business significantly. YS Group may also elect to enter into license agreements in order to settle patent infringement claims or to resolve disputes prior to litigation, and any such license agreements may require YS Group to pay royalties and other fees that could significantly harm YS Group's business.

Even if resolved in YS Group's favor, litigation or other legal proceedings relating to YS Group's other third parties' intellectual property claims may cause YS Group to incur significant expenses and could distract YS Group's personnel from its normal responsibilities. In addition, there could be public announcements of the results of hearings, motions, or other interim proceedings or developments, and if securities analysts or investors perceive these results to be negative, it could have a substantial adverse effect on the price of YS Group's common stock. Such litigation or proceedings could substantially increase YS Group's operating losses and reduce the resources available for development activities or any future sales and marketing activities. YS Group may not have sufficient financial or other resources to conduct such litigation or proceedings adequately. Some of YS Group's competitors may be able to sustain the costs of such litigation or proceedings more effectively than YS Group can because of their greater financial resources and more mature and developed intellectual property portfolios.

Uncertainties resulting from the initiation and continuation of patent litigation or other proceedings could have a material adverse effect on YS Group's ability to compete in the marketplace.

***The success of YS Group's business may depend on licensing, collaboration and other strategic arrangements with third parties, and YS Group cannot assure you that its licensing, collaboration or other strategic efforts will succeed or that YS Group will derive any benefits from these arrangements.***

YS Group has entered into collaboration agreements with third parties from time to time to jointly develop vaccines and other biologics. See the section entitled "YS Group's Business—YS Group's Strategic Collaborations" for details. The success of YS Group's business strategy depends, in part, on its ability to enter into licensing, collaboration and other strategic arrangements and to manage effectively the resulting relationships. YS Group cannot assure you that the organizations or institutes it collaborates with will not terminate such cooperation's or enter into collaborative relationships with its competitors in the future.

YS Group's ability to enter into agreements with commercial partners depends in part on its ability to convince them of the value of YS Group's technology, expertise, know-how or distribution channel. This may require substantial time and effort on YS Group's part. While YS Group anticipates expending substantial funds and management efforts, YS Group cannot assure you that collaborative relationships will result or that YS Group will be able to negotiate additional collaborative agreements in the future on acceptable terms, if at all. Furthermore, YS Group may incur significant financial commitments to partners in connection with potential licenses, collaboration or other agreements. In addition, YS Group may not be able to control the areas of responsibility undertaken by its commercial partners and its business may suffer greatly should these partners prove unable to carry a product candidate forward to full commercialization, lose interest in dedicating the necessary resources toward developing any such product quickly, fail to implement the appropriate quality control measures in their manufacture of the products licensed to them by YS Group or decline to expend the necessary effort or resources to market and sell such products.

Moreover, third parties may terminate YS Group's licensing, collaboration and other strategic arrangements if YS Group does not perform as required under these arrangements. In addition, these third parties may also breach or terminate their agreements with YS Group or otherwise fail to conduct their activities in connection with its relationships in a timely manner. If YS Group or its partners terminate or breach any of YS Group's licenses or relationships, YS Group may:

- lose the rights to manufacture, market or sell certain products;
- experience significant delays in the development or commercialization of product candidates;
- not be able to obtain any other licenses on acceptable terms, if at all;
- initiate legal proceedings against YS Group's former partners or have such proceedings initiated against it and
- incur liability for damages.

Licensing arrangements and collaborative relationships in YS Group's industry can be very complex, particularly with respect to intellectual property rights. Disputes may arise in the future regarding ownership rights to technology developed by or with other parties. These and other possible disagreements between YS Group and third parties with respect to YS Group's licenses or their collaborative relationships could lead to delays in the research, development, manufacture and commercialization of current product or product candidates. These disputes could also result in litigation or arbitration, both of which are time-consuming and expensive. These third parties also may pursue alternative technologies or product candidates either on their own or in collaborative relationships with others in direct competition with YS Group.

***Intellectual property rights do not necessarily address all potential threats.***

The degree of future protection afforded by YS Group's intellectual property rights is uncertain because intellectual property rights have limitations and may not adequately protect its business or permit YS Group to maintain its competitive advantage. For example:

- others may be able to make vaccines and other biologics that are similar to any marketed product or product candidates YS Group may develop or utilize similar technology but that are not covered by the claims of the patents that YS Group may own or in-license in the future;
- YS Group, patent owners of patent rights that YS Group may in-license, or current or future collaborators might not have been the first to make the inventions covered by the issued patent or pending patent application that YS Group licenses or may owns in the future;
- YS Group, patent owners of patent rights that YS Group may in-license, or current or future collaborators might not have been the first to file patent applications covering certain of YS Group's or their inventions;
- others may independently develop similar or alternative technologies or duplicate any of YS Group's technologies without infringing, misappropriating or otherwise violating YS Group's owned or licensed intellectual property rights;
- it is possible that YS Group's pending patent applications or those that YS Group may own in the future will not lead to issued patents;
- issued patents that YS Group holds rights to may be held invalid or unenforceable, including as a result of legal challenges by its competitors;
- YS Group's competitors might conduct research and development activities in countries where YS Group does not have patent rights and then use the information learned from such activities to develop competitive products for sale in YS Group's major commercial markets;
- YS Group may not develop additional proprietary technologies that are patentable;
- the patents of others may harm YS Group's business; and
- YS Group may choose not to file a patent in order to maintain certain trade secrets or know how, and a third party may discover certain technologies containing such trade secrets or know how through independent research and development and/or subsequently file a patent covering such intellectual property.

Should any of these events occur, it could have a material adverse effect on YS Group's business, financial condition, results of operations and prospects.

#### **Risks related to YS Group's General Operations**

##### ***YS Group's business, results of operations and financial position could be adversely affected by the ongoing COVID-19 pandemic.***

Beginning in early 2020, there was an outbreak of a novel strain of coronavirus, later named COVID-19. In March 2020, the WHO declared COVID-19 to be a pandemic. As part of its intensified efforts to contain the spread of COVID-19, governments across the world took a number of actions, including imposing lockdown policies which restrict citizens to travel outside, quarantining and otherwise treating individuals who are infected with COVID-19, asking residents to remain at home and to avoid public gatherings and encouraging work-from-home arrangements, among other actions. COVID-19 has resulted in temporary closures of many corporate offices, retail stores, and manufacturing facilities and factories across China.

Many of the restrictive measures previously adopted by the PRC governments at various levels to control the spread of the COVID-19 virus have been revoked or replaced with more flexible measures since December 2022. While the revocation or replacement of the restrictive measures to contain the COVID-19 pandemic could have a positive impact on YS Group's normal operations, it may also shift the public's interest in COVID-19 vaccines. Moreover, there has recently been and may continue to be an increase in COVID-19 cases in China, and as a result, we experienced temporary disruption to our operations where many employees were infected with COVID-19 in December 2022. The extent to which the COVID-19 pandemic impacts YS Group's business, prospects and results of operations will depend on future developments, which are highly uncertain and cannot be predicted, including, but not limited to, the duration and spread of the pandemic, its severity, the actions to contain the virus or treat its impact, and when and to what extent normal economic and operating activities can resume. The COVID-19 pandemic could limit the ability of customers, suppliers, vendors and business partners to perform, including third-party suppliers' ability to provide components and

materials used in batteries or in providing installation or maintenance services. Even after the COVID-19 pandemic has subsided, Specifically, difficult macroeconomic conditions, such as decreases in per capita income and level of disposable income, increased and prolonged unemployment or a decline in consumer confidence as a result of the COVID-19 pandemic, as well as reduced spending by businesses, could each have a material adverse effect on the demand for YS Group's products and services. YS Group cannot accurately forecast the potential impact of additional outbreaks, further shelter-in-place or other government restrictions implemented in response to such outbreaks, or the impact on the ability of YS Group's suppliers and other business partners to remain in business as a result of the ongoing pandemic or such additional outbreaks. With the uncertainties surrounding the COVID-19 outbreak, the threat to YS Group's business disruption and the related financial impact remains.

***YS Group has limited operating experience and management teams in the international market. YS Group's international expansion plan may expose YS Group to risks associated with international manufacturing, sales and operations.***

YS Group has established research and development bases in China, the United States and Singapore, and may further expand its manufacturing, customer bases and operations globally. However, YS Group has limited operating experience and management teams in the international market. As of the date of this proxy statement/prospectus, YS Group is still at early stage in setting up its international operation for the sales, marketing and distribution of its immunological biologics. Managing an international organization is difficult, time-consuming and expensive. YS Group's lack of a track record in operating a business internationally increases the risk that any current or potential future international expansion efforts may not be successful. In addition, conducting international operations subjects YS Group to new risks that it has not generally faced. These risks that may materially adversely affect YS Group's ability to attain or sustain profitable operations include:

- localization of YS Group's products, including adaptation to local practices and regulatory requirements;
- production shortages resulting from any events affecting raw material supply or manufacturing capabilities abroad;
- efforts to enter into collaboration with third parties in connection with YS Group's international sales and operations that may increase its expenses or divert its management's attention from the acquisition or development of product candidates;
- changes in a specific country's or region's political and cultural climate or economic condition;
- lack of familiarity with and unexpected changes in applicable foreign regulatory regimes;
- difficulty of effective enforcement of contractual provisions in local jurisdictions;
- more extended accounts receivable payment cycles and difficulties in collecting payments;
- difficulties in managing and staffing overseas operations;
- compliance with tax, employment, immigration and labor laws for employees traveling abroad;
- workforce uncertainty and labor unrest;
- fluctuations in foreign currency exchange rates, which could result in increased operating expenses and reduced revenue, and other obligations incidental to doing business in another country or region;
- potentially adverse tax consequences, including the complexities of transfer pricing, foreign value-added tax systems and restrictions on the repatriation of earnings;
- unexpected changes in tariffs, trade barriers and regulatory requirements;
- dependence on certain third parties, such as local distributors or joint venture partners, with whom YS Group does not have extensive experience;
- potential third-party patent rights;
- increased financial accounting and reporting burdens and complexities;

- political, social, and economic instability abroad, including war and terrorism, and security concerns in general such as natural disasters; and
- reduced or varied protection for intellectual property rights in certain jurisdictions.

Operating in international markets also requires significant management attention and financial resources. YS Group cannot assure you that the investment and additional resources required to establish operations and manage growth in other countries would produce anticipated levels of revenue or profitability, and that any international expansion would be successful and would not have a material adverse effect on YS Group's business, financial condition and results of operations.

***YS Group faces certain risks related to its real properties.***

YS Group leased multiple real properties in several countries from third parties. Should disputes arise due to YS Group's use of or title encumbrances to such property or government action, YS Group may encounter difficulties in continuing to lease such property and may be required to relocate in the future. As of the date of this proxy statement/prospectus, YS Group was not aware of any claim or challenge brought by any third party or governmental authorities concerning the use of such leased property. YS Group cannot assure you that in the future, it may not encounter such challenges. In addition, in the event of relocation, YS Group may incur additional costs, which could adversely affect its daily operation and cause an impact on YS Group's financial condition.

In addition, as a vaccine manufacturing enterprise, YS Group currently holds certain parcel of lands to expand its manufacturing or R&D capacities. Under current PRC laws and regulations, if YS Group fails to commence the construction for more than one year from the commencement date stipulated in the land use right grant contracts, the relevant PRC land bureau may serve an investigation notice and impose an idle land fee of up to 20% of the land use right premium on YS Group unless the delay is caused by government actions or force majeure. If YS Group fails to commence the construction for more than two years, the land may be subject to forfeiture by the PRC government unless the delay is caused by government actions or force majeure. In addition to the administrative penalties, YS Group may be subject to civil liability as stipulated under the contracts. YS Group cannot assure you that it is and will be fully in compliance with the obligations under the land use right grant contract or listing-for-sale letters in the future due to factors which are beyond YS Group's control. If YS Group fails to comply with the terms of any land grant contract or listing-for-sale confirmation letter as a result of delays in any reasons other than government actions or force majeure, YS Group may have financial loss or lose its previous investments in the land, which may have a material adverse effect on its business, results of operations and financial condition.

Moreover, YS Group is required to obtain a series of approval, filing, permit or license before YS Group commences the construction under PRC laws and regulations. As of the date of this proxy statement/prospectus, YS Group commenced construction or improvement of certain facilities and its use before obtaining the relevant approvals, permits and filings or going through the requisite procedures regarding, among others, construction, environmental protection, fire prevention and safety conditions. YS Group cannot assure you that it has obtained and fully complied, or will be able to obtain and fully comply with such approval, filing, permit, license or other requisite procedures. If YS Group is found to be non-compliant with relevant laws and regulation, the relevant authorities may suspend or halt YS Group's construction or production as well as impose fines and penalties. For example, in case YS Group failed to obtain the relevant approval from environmental authorities, if necessary, for its construction projects before its construction activities, a fine up to 5% of the total investment amount of such construction project might be imposed on YS Group. Any non-compliance of relevant requirements on, including but not limited to construction, environmental protection, fire prevention and safety conditions, may adversely affect YS Group's results of operations and financial condition.

***YS Group may be subject to fines and penalties under applicable PRC laws and regulations for failure to make adequate contributions to social insurance and housing reserve fund for its employees.***

Pursuant to relevant PRC laws and regulations, employers are obligated to directly and duly make social insurances and housing reserve fund contributions for their employees. YS Group cannot assure you that its employment practice has been and will at all times be deemed to be in full compliance with labor-related laws

and regulations in China, which may subject YS Group to labor disputes or government investigations and administrative penalties. If YS Group is deemed to have violated relevant labor laws and regulations, YS Group could be required to provide additional compensation to its employees and its business, financial condition and results of operations could be materially and adversely affected. Historically, YS Group did not make adequate social insurance and housing provident fund contributions for its employees as required by the relevant PRC laws and regulations.

YS Group has rectified the issue and made adequate social insurances and housing reserve fund contributions for all of its eligible employees. YS Group has paid all the overdue principal amount and late charge in relation to its social insurances and housing reserve fund contributions for all current employees and certain former employees, and YS Group is in the process of communicating with the remaining former employees to complete the administrative procedure as the prerequisite for making such payments as of the date of this proxy statement/prospectus. YS Group has also made provision for the historical inadequate contributions in its financial statements. As of the date of this proxy statement/prospectus, YS Group was not aware of any pending orders or demands from the relevant PRC government authorities requesting YS Group to pay these unpaid contributions, complete the registration or pay any penalties. If the relevant PRC government authorities order YS Group to make the outstanding contributions or impose penalties on it, or if YS Group's provision in its financial statements turns out to be insufficient, YS Group's business, financial condition and results of operations could be adversely affected. As the interpretation and implementation of labor-related laws and regulations are still evolving, YS Group cannot assure you that its current employment practices do not and will not violate labor-related laws and regulations in China, which may subject it to labor disputes or government investigations. In addition, it may incur additional expenses in order to comply with such laws and regulations, which may adversely affect its business and profitability.

***Enhanced scrutiny over acquisition transactions by the PRC tax authorities may have a negative impact on potential acquisitions YS Group may pursue in the future.***

Pursuant to the Notice on Strengthening Administration of Enterprise Income Tax for Share Transfers by Non-PRC Resident Enterprises, or SAT Circular 698, issued by the PRC's State Taxation Administration, or the SAT, on December 10, 2009, where a foreign investor transfers the equity interests of a resident enterprise indirectly via disposition of the equity interests of an overseas holding company, or an "indirect transfer," and such overseas holding company is located in a tax jurisdiction that (i) has an effective tax rate less than 12.5% or (ii) does not tax foreign income of its residents, the foreign investor shall report the indirect transfer to the competent PRC tax authority. The PRC tax authority will examine the true nature of the indirect transfer, and if the tax authority considers that the foreign investor has adopted an "abusive arrangement" in order to avoid PRC tax, it may disregard the existence of the overseas holding company and re-characterize the indirect transfer and as a result, gains derived by the non-PRC tax resident enterprises from such indirect transfer may be subject to PRC withholding tax at a rate of up to 10%.

On February 3, 2015, the SAT issued the Announcement of the State Administration of Taxation on Several Issues Concerning the Enterprise Income Tax on Indirect Property Transfer by Non-Resident Enterprises, or SAT Bulletin 7, to supersede existing provisions in relation to the "indirect transfer" as set forth in SAT Circular 698, while the other provisions of SAT Circular 698 remained in force. Pursuant to SAT Bulletin 7, where a non-resident enterprise indirectly transfers properties such as equity in PRC resident enterprises without any justifiable business purposes and aiming to avoid the payment of enterprise income tax, such indirect transfer must be reclassified as a direct transfer of equity in PRC resident enterprise. To assess whether an indirect transfer of PRC taxable properties has reasonable commercial purposes, all arrangements related to the indirect transfer must be considered comprehensively and factors set forth in SAT Bulletin 7 must be comprehensively analyzed in light of the actual circumstances.

On October 17, 2017, the SAT issued the Announcement of the State Administration of Taxation on Matters Concerning Withholding of Income Tax of Non-resident Enterprises as Source, or SAT Bulletin 37, which repealed the entire SAT Circular 698 and the provision in relation to the time limit for the withholding agent to declare to the competent tax authority for payment of such tax of SAT Bulletin 7. Pursuant to SAT Bulletin 37, the income from a property transfer, as stipulated in the second item under Article 19 of the Enterprise Income Tax Law, shall include the income derived from transferring such equity investment assets as stock equity. The balance of deducting the equity's net value from the total income from equity transfer

shall be taxable income from equity transfer. Where a withholding agent enters into a business contract, involving the income specified in the third paragraph of Article 3 in the Enterprise Income Tax Law, with a non-resident enterprise, the tax-excluding income of the non-resident enterprise will be treated as the tax-including income, based on which the tax payment will be calculated and remitted, if it is agreed in the contract that the withholding agent shall assume the tax payable.

During the effective period of SAT Circular 698 and by the application of SAT Bulletin 7 and SAT Bulletin 37, some intermediary holding companies were actually looked through by the PRC tax authorities, and consequently the non-PRC resident investors were deemed to have transferred the PRC subsidiary and PRC corporate taxes were assessed accordingly. It is possible that YS Group or its non-PRC resident investors may at some point be at risk of being taxed under SAT Bulletin 7 and SAT Bulletin 37 and may be required to expend valuable resources to comply with SAT Bulletin 7 and SAT Bulletin 37 or to establish that YS Group or its non-PRC resident investors should not be taxed under SAT Bulletin 7 and SAT Bulletin 37, which may have an adverse effect on YS Group's financial condition and results of operations or such non-PRC resident investors' investment in YS Group.

***YS Group depends substantially on the continuing efforts of its senior executives, key research and development personnel and commercialization personnel, and YS Group's business and prospects may be severely disrupted if YS Group loses their services.***

YS Group's future success depends heavily upon the continued service of its senior management and key research and development and commercialization personnel. In particular, YS Group relies on the expertise and experience of Mr. Yi Zhang, YS Group's founder and chairman in YS Group's business operations, and on his personal relationships with the regulatory authorities, YS Group's customers, suppliers and employees. YS Group also rely on the healthcare industry-related experience and professional knowledge of its other senior officers. YS Group's research and development team is critical to the development and commercialization of product candidates and realization of the potential benefits of its intellectual property, including YS Group's proprietary PIKA immunomodulatory technology platform. YS Group's ability to attract and retain key personnel, in particular, senior management, key research and development personnel and commercialization personnel, is a critical aspect of its competitiveness. Competition for these individuals could require YS Group to offer higher compensation and other benefits in order to attract and retain them, which would increase its operating expenses and, in turn, could materially and adversely affect its results of operations and financial condition. YS Group may be unable to attract or retain the personnel required to achieve its business objectives, and failure to do so could severely disrupt its business and prospects. The loss of any of YS Group's key employees, including senior executives, key research and development personnel or commercialization personnel, could materially harm its business and prospects.

YS Group does not maintain key-person insurance for members of its management team. If YS Group loses the services of any senior management, YS Group may not be able to locate suitable or qualified replacements, and may incur additional expenses to recruit and train new personnel, which could severely disrupt YS Group's business and prospects. Furthermore, if any of YS Group's executive officers joins a competitor or forms a competing company, YS Group may lose a significant number of its existing customers, which could have a material adverse effect on YS Group's business and revenues. Although each of YS Group's executive officers has entered into an agreement with YS Group that contains confidentiality and non-competition undertakings regarding their employment, disputes may arise between YS Group's executive officers and YS Group, and these agreements may not be enforced in accordance with their terms.

***YS Group may pursue collaborations, in-licensing arrangements, joint ventures, strategic alliances, partnerships or other strategic investment or arrangements, which may fail to produce anticipated benefits and adversely affect YS Group's business.***

YS Group collaborates with research organizations and government agencies to supplement its in-house efforts and advance the development of its product candidates. YS Group may pursue other opportunities for collaboration, in-licensing, joint ventures, acquisitions of products, assets or technology, strategic alliances, or partnerships that YS Group believes would be complementary to or promote its existing business. Proposing, negotiating and implementing these opportunities may be a lengthy and complex process. Other companies, including those with substantially greater financial, marketing, technology, or other business resources, may

compete with YS Group for these opportunities or arrangements. YS Group may not be able to identify, secure, or complete any such transactions or arrangements in a timely manner, on a cost-effective basis, on acceptable terms, or at all.

YS Group has limited experience with respect to these business development activities. Management and integration of a licensing arrangement, collaboration, joint venture or other strategic arrangement may disrupt YS Group's current operations, decrease YS Group's profitability, result in significant expenses, or divert management resources that otherwise would be available for its existing business. YS Group may not realize the anticipated benefits of any such transaction or arrangement.

Furthermore, partners, collaborators or other parties to such transactions or arrangements may fail to fully, or at all, perform their obligations or meet YS Group's expectations or cooperate with YS Group satisfactorily for various reasons, including risks or uncertainties related to their business and operations. There may be conflicts or other collaboration failures and inefficiencies between YS Group and the other parties.

Such transactions or arrangements may also require actions, consents, approvals, waivers, participation or involvement of various degrees from third parties, such as regulators, government authorities, creditors, licensors or licensees, related individuals, suppliers, distributors, shareholders or other stakeholders or interested parties. There is no assurance that such third parties will be cooperative as YS Group desires, or at all, in which case YS Group may be unable to carry out the relevant transactions or arrangements.

***YS Group may not be able to complete new acquisitions successfully. Even if YS Group successfully acquires companies, products or technologies, YS Group may face integration risks and costs associated with those acquisitions that could negatively impact its business, financial condition and results from operations.***

Acquisitions have been, and are expected to continue to be, an important part of YS Group's growth strategies. For example, YS Group has established its proprietary PIKA immunomodulatory technology platform through the acquisition of NewBiomed in June 2010. If YS Group is presented with appropriate opportunities, YS Group may make additional acquisitions of complementary businesses, products, product candidates or technologies. Any such acquisitions will be dependent upon the continued availability of suitable acquisition targets at favorable prices and upon advantageous terms and conditions. Even if such opportunities are present, YS Group may not be able to successfully identify such acquisition targets. Moreover, other companies, many of which may have substantially greater financial, marketing and sales resources, are competing with YS Group for the right to acquire such businesses, products, product candidates or technologies. If an acquisition target is identified, the management and shareholders of the acquisition target may not select YS Group as a potential partner or YS Group may not be able to enter into agreements on commercially reasonable terms or at all. Furthermore, the negotiation and completion of potential acquisitions could cause significant diversion of YS Group's management's time and resources and potential disruption of its ongoing business.

In addition, YS Group cannot assure you that it will realize the anticipated benefit of any acquisition or investment. If YS Group acquires companies or technologies, YS Group will face risks, uncertainties and disruptions associated with the integration process, including difficulties in the integration of the operations of an acquired company, integration of acquired technology with its products, diversion of its management's attention from other business concerns, the potential loss of key employees or customers of the acquired business, the potential involvement in any litigation related to the acquired company, and impairment charges if acquisitions are not as successful as YS Group originally anticipate. In addition, YS Group's results of operations may suffer because of acquisition-related costs or amortization expenses or charges relating to acquired intangible assets. As of March 31, 2021 and 2022 and September 30, 2022, YS Group had RMB83.8 million, RMB80.7 million (\$12.7 million) and RMB81.3 million (\$11.5 million) in intangible assets, respectively. Any failure to successfully integrate other companies, products or technologies that YS Group may acquire may have a material adverse effect on its business, financial condition and results of operations.

***YS Group will likely need substantial additional funding for its new and existing product development programs and commercialization efforts, which may not be available on acceptable terms, or at all. If YS Group is unable to raise capital on acceptable terms when needed, YS Group could incur losses or be forced to delay, reduce or terminate such efforts.***

YS Group's operations have consumed substantial amounts of cash since inception. The net cash used in YS Group's operating activities was RMB246.6 million, RMB173.5 million (\$27.3 million) and RMB107.4 million



(\$15.1 million) for the fiscal years ended March 31, 2021 and 2022 and the six months ended September 30, 2022, respectively. YS Group expects its expenses to increase in connection with YS Group's ongoing activities, particularly as YS Group launch and expand the sale of YSJA™ rabies vaccine, advance the clinical trial of its product candidates and continue research and development of its preclinical stage product candidates, and initiate additional clinical trials of, and seek regulatory approval for, these and other future product candidates. In addition, if YS Group obtain regulatory approval for any of its product candidates, it expects to incur significant commercialization expenses related to product manufacturing, marketing and sales. In particular, the costs that may be required for the manufacture of any product candidate that receives regulatory approval may be substantial as YS Group may have to modify or increase the production capacity at its current manufacturing facilities or contract with third party manufacturers. YS Group may also incur expenses as it creates additional infrastructure to support its operations as a public company. Accordingly, YS Group will likely need to obtain substantial additional funding in connection with its continuing operations through public or private equity offerings, debt financing, collaborations or licensing arrangements or other sources.

YS Group's ability to obtain additional capital in the future is subject to a variety of uncertainties, including:

- YS Group's future financial condition, results of operations and cash flows;
- the condition of Hong Kong and other capital markets in which YS Group may seek to raise funds;
- investors' perception of, and demand for, securities of biopharmaceutical companies; and
- economic, political and other conditions in China and elsewhere.

If YS Group is unable to raise capital when needed or on acceptable terms, it could incur losses and be forced to delay, reduce or terminate its research and development programs or any future commercialization efforts. To the extent that YS Group raises additional capital through the sale of equity or convertible debt securities, your ownership interest will be diluted, and the terms may include liquidation or other preferences that adversely affect your rights. The incurrence of additional indebtedness or the issuance of certain equity securities could result in increased fixed payment obligations and could also result in certain additional restrictive covenants, such as limitations on YS Group's ability to incur additional debt or issue additional equity, limitations on YS Group's ability to acquire or license intellectual property rights and other operating restrictions that could adversely impact YS Group's ability to conduct its business. In addition, issuance of additional equity securities, or the possibility of such issuance, may cause the market price of YS Group's Shares to decline.

***Any catastrophe, including outbreaks of health pandemics and other extraordinary events, could have a negative impact on YS Group's business operations.***

YS Group is vulnerable to natural disasters and other calamities. Fire, floods, typhoons, earthquakes, power loss, telecommunications failures, break-ins war, riots, terrorist attacks or similar events may give rise to server interruptions, breakdowns, system failures or Internet failures, which could cause the loss or corruption of data or malfunctions of software or hardware as well as adversely affect YS Group's ability to provide its services.

YS Group's business could also be adversely affected by the effects of Ebola virus diseases, H1N1 flu, H7N9 flu, avian flu, Severe Acute Respiratory Syndrome (SARS), COVID-19, or other existing or emerging epidemics in China and globally. YS Group's business operation could be disrupted if any of its employees is suspected of having any of the aforementioned epidemics or another contagious disease or condition, since it could require YS Group's employees to be quarantined and/or YS Group's offices to be disinfected. In addition, YS Group's business, results of operations and financial condition could be adversely affected to the extent that any of these epidemics harms the Chinese economy in general. For example, an outbreak of COVID-19 has and is continuing to spread rapidly throughout China and many other parts of the world since 2019. The exacerbation, continuance or reoccurrence of COVID-19 has already caused and may continue to cause an adverse and prolonged impact on the economy and social conditions in China and other affected countries. The existing clinical trials and the commencement of new clinical trials could be substantially disrupted, delayed or prevented by any delay or failure in patient recruitment or enrollment in YS Group's or YS Group's collaborators' trials as a result of the outbreak of COVID-19. The quality of YS Group's clinical trials can also be substantially and negatively affected or be subject to uncertainties due to the outbreak of

COVID-19. These factors could cause delay of clinical trials, regulatory submissions, and required approvals of YS Group's product candidates, and could cause YS Group to incur additional costs. If YS Group's employees or employees of YS Group's business partners are suspected of being infected with an epidemic disease, YS Group's operations may be disrupted because YS Group or YS Group's business partners must quarantine some or all of the affected employees or disinfect the operating facilities. If YS Group is not able to effectively develop and commercialize its product candidates as a result of protracted clinical trials of enrolled patients, elevated public health safety measures, and/or failure to recruit and conduct patient follow-up, YS Group may not be able to generate revenue from sales of its product candidates as planned. All of the foregoing could have a material adverse effect on YS Group's results of operations and financial condition in the near term.

***A severe or prolonged downturn in Chinese or global economy could materially and adversely affect YS Group's business, results of operations, financial condition and prospects.***

It remains uncertain whether and when COVID-19 will be controlled globally and whether it will lead to a prolonged downturn in the economy. Even before the outbreak of COVID-19, the global macroeconomic environment was facing numerous challenges. The growth rate of the Chinese economy had already been slowing since 2010, and the impact of COVID-19 on the Chinese economy in 2020 is likely to be severe. There is considerable uncertainty over the long-term effects of the expansionary monetary and fiscal policies which had been adopted by the central banks and financial authorities of some of the world's leading economies, including the United States and China, even before 2020. Unrest, terrorist threats and the potential for war in the Middle East and elsewhere may increase market volatility across the globe. There have also been concerns about the relationship between China and other countries, including the surrounding Asian countries, which may potentially have economic effects. In particular, there is significant uncertainty about the future relationship between the United States and China with respect to trade policies, treaties, government regulations and tariffs. Economic conditions in China are sensitive to global economic conditions, as well as changes in domestic economic and political policies and the expected or perceived overall economic growth rate in China. Any severe or prolonged slowdown in the global or Chinese economy may materially and adversely affect YS Group's business, results of operations and financial condition.

***YS Group may seek orphan drug exclusivity for some of its product candidates, which may not be successful.***

Regulatory authorities in some jurisdictions, including the United States, may designate drugs for relatively small patient populations as orphan drugs. Under the Orphan Drug Act, the U.S. FDA may designate a drug as an orphan drug if it is a drug intended to treat a rare disease or condition, which is generally defined as a disease with a patient population of fewer than 200,000 individuals in the United States. Generally, if a drug with an ODD subsequently receives the first regulatory approval for the indication for which it has such designation, the drug is entitled to a period of marketing exclusivity, which precludes the U.S. FDA, from approving another marketing application for the same drug for the same indication during the period of exclusivity. The applicable period varies in different jurisdictions, which is seven years in the United States. Orphan drug exclusivity may be lost if the U.S. FDA determines that the request for designation was materially defective or if the manufacturer is unable to assure sufficient quantity of the drug to meet the needs of patients with the rare disease or condition.

YS Group has obtained ODD for certain of its product candidates, including PIKA rabies vaccine and PIKA YS-ON-001. However, such designation cannot completely protect this product from future competition. The exclusivity may not effectively protect YS Group's product candidates from competition because different drugs can be approved for the same condition and the same drugs can be approved for a different condition but used off-label for any orphan indication YS Group may obtain. Even after an orphan drug is approved, the U.S. FDA can subsequently approve a different drug for the same condition if the U.S. FDA concludes that the later drug is clinically superior in that it is shown to be safer, more effective or makes a major contribution to patient care.

The incidence and prevalence for target patient populations of YS Group's product candidates are based on estimates and third-party sources. If the market opportunities for YS Group's product candidates are smaller than it estimates or if any approval that YS Group obtains is based on a narrower definition of the patient population, YS Group's revenue and ability to achieve profitability might be materially and adversely affected.

YS Group makes periodical estimates regarding the incidence and prevalence of target patient populations for particular diseases based on various third-party sources and internally generated analysis and use such estimates in making decisions regarding YS Group's products development strategy, including acquiring or in-licensing products candidates and determining indications on which to focus in preclinical or clinical trials.

These estimates may be inaccurate or based on imprecise data. For example, the total addressable market opportunity will depend on, among other things, their acceptance by the medical community and patient access, pricing and reimbursement. The number of patients in the addressable markets may turn out to be lower than expected, patients may not be otherwise amenable to treatment with YS Group's products, or new patients may become increasingly difficult to identify or gain access to, all of which may significantly harm YS Group's business, financial condition, results of operations and prospects.

## **RISKS RELATED TO DOING BUSINESS IN CHINA**

***Additional disclosure requirements to be adopted by and regulatory scrutiny from the SEC in response to risks related to companies with substantial operations in China, which could increase the compliance costs of YS Group or the YS Biopharma following the consummation of the Business Combination, subject it to additional disclosure requirements, and/or suspend or terminate its future securities offerings, making capital-raising more difficult.***

On July 30, 2021, in response to the recent regulatory developments in China and actions adopted by the PRC government, the Chairman of the SEC issued a statement asking the SEC staff to seek additional disclosures from offshore issuers associated with China-based operating companies before their registration statements will be declared effective. As such, the Business Combination and offering of YS Biopharma's securities may be subject to additional disclosure requirements and review that the SEC or other regulatory authorities in the United States may adopt for companies with China-based operations, which could increase the compliance costs of YS Group or the YS Biopharma following the Business Combination, subject it to additional disclosure requirements, and/or suspend or terminate YS Group's future securities offerings, making capital-raising more difficult. YS Group or YS Biopharma following the consummation of the Business Combination may also be required to adjust, modify, or completely change its business operations in response to adverse regulatory changes or policy developments, and YS Group cannot assure you that any remedial action adopted by them can be completed in a timely, cost-efficient, or liability-free manner or at all.

***Recent regulatory development in China may exert more oversight and control over listing and offerings that are conducted overseas such as the Business Combination. The approval and/or other requirements of PRC governmental authorities may be required in connection with the Business Combination or YS Biopharma's future issuance of securities on Nasdaq under PRC laws, regulations or policies.***

YS Group has conducted a substantial portion of its business in China, including, among others, manufacturing and sales of YSJA<sup>TM</sup> rabies vaccines and certain research and development activities. As such, YS Biopharma and its subsidiaries are subject to PRC laws relating to, among others, restrictions over foreign investments and data security. The Chinese government has recently sought to exert more control and impose more restrictions on China-based companies raising capital offshore and such efforts may continue or intensify in the future. The Chinese government has recently indicated an intent to exert more oversight and control over securities offerings and other capital markets activities that are conducted overseas and foreign investment in China-based companies like YS Group, which could result in a material change in YS Group's operations, significantly limit or completely hinder YS Biopharma's ability to offer or continue to offer securities on Nasdaq, and cause the value of YS Biopharma's securities to significantly decline or be worthless. Based on the opinion of YS Biopharma's PRC counsel, Jingtian & Gongcheng, according to its interpretation of the currently in-effect PRC laws and regulations, YS Biopharma believes that the issuance of YS Biopharma's securities on Nasdaq in connection with the Business Combination does not require permission or approval from PRC governmental authorities, including the CSRC. However, as PRC governmental authorities have significant discretion in interpreting and implementing statutory provisions, YS Biopharma cannot assure you that such approval or permission or other filings will not be required under PRC laws, regulations or policies if the relevant PRC governmental authorities take a contrary position, nor can YS Biopharma predict whether or how long it will take to obtain such approval, permission or other filings in connection with the Business Combination or future issuance of securities on Nasdaq. Any failure to obtain or delay in obtaining

the requisite governmental approval, permission or other filings for the Business Combination or future issuance of securities on Nasdaq or a rescission of such approval, permission or other filings, would subject YS Group to sanctions imposed by the relevant PRC regulatory authority.

Under the current Regulations on Mergers and Acquisitions of Domestic Companies by Foreign Investors adopted by six PRC regulatory agencies, including the Ministry of Commerce of the PRC (the “MOFCOM”), the State-Owned Assets Supervision and Administration Commission, the SAT, the State Administration for Industry and Commerce, currently known as the SAMR, the CSRC, and the SAFE in 2006 and amended in 2009, as well as some other regulations and rules concerning mergers and acquisitions (collectively, the “M&A Rules”) include provisions that purport to require that an offshore special purpose vehicle that is controlled by PRC domestic companies or individuals and that has been formed for the purpose of an overseas listing of securities through acquisitions of PRC domestic companies or assets to obtain the approval of the CSRC prior to the listing and trading of such special purpose vehicle’s securities on an overseas stock exchange. On September 21, 2006, the CSRC published its approval procedures for overseas listings by special purpose vehicles. However, substantial uncertainty remains regarding the scope and applicability of the M&A Rules to offshore special purpose vehicles. While the application of the M&A Rules remains unclear, YS Biopharma believes, based on the advice of YS Biopharma’s PRC legal counsel and its understanding of the current PRC laws and regulations, that the CSRC approval under the M&A Rules is not required in the context of the Business Combination because (i) the PRC subsidiaries of YS Biopharma were owned by YS Biopharma indirectly through equity before the Business Combination and Business Combination does not involve any merger or acquisition, directly or indirectly, of the equity interest or assets of any “domestic company,” as defined under the M&A Rules, and (ii) the CSRC currently has not issued any definitive rule or interpretation concerning whether a transaction of the kind contemplated herein are subject to the M&A Rules. There can be no assurance that the relevant PRC government agencies, including the CSRC, would reach the same conclusion as YS Biopharma’s PRC legal counsel.

On August 1, 2021, the CSRC stated in a statement that it had taken note of the new disclosure requirements announced by the SEC regarding the listings of Chinese companies and the recent regulatory development in China, and that both countries should strengthen communications on regulating China-related issuers.

Furthermore, on December 24, 2021, the CSRC released the draft Administrative Provisions on the Offshore Listing and Securities Issuance of PRC-Based Companies and the draft Administrative Measures on the Filing of Offshore Listing and Securities Issuance of PRC-Based Companies for public comments through January 23, 2022 (collectively, the “CSRC Draft Rules”). Under the CSRC Draft Rules, issuers that intend to list or offer securities on foreign stock exchanges through direct offshore listing (i.e., the listing of a PRC-incorporated company) or indirect offshore listing (i.e., the listing of an overseas company that meets the following conditions: (a) more than 50% of the revenue, profit, gross assets or net assets of the issuer in the last fiscal year originated from a PRC-incorporated company or companies, and (b) a majority of the issuer’s senior executives in charge of its business operations are PRC citizens or habitually reside in the PRC and the issuer’s business operations are mainly conducted or located in the PRC) shall complete a filing with the CSRC within three business days upon the issuer’s submission of its initial public offering and listing application documents with the foreign stock exchange. The relevant filing materials include but are not limited to: (i) the filing report and relevant undertakings; (ii) regulatory opinions issued by, filings with or approvals from competent authorities of YS Group’s industry, if applicable; (iii) security assessment review opinions issued by competent authorities, if applicable; (iv) opinions issued by a PRC legal counsel; and (v) the prospectus used for the overseas listing. If the filing documents submitted to the CSRC are complete and in compliance with the applicable requirements, the CSRC will issue a notice of record within 20 business days. According to questions and answers published by the CSRC on December 24, 2021 (the “Q&A”), the CSRC Draft Rules, as drafted, would not be applied retrospectively and would only be applied to new listings and refinancing by existing overseas-listed Chinese companies. It is uncertain whether, when and in what form the CSRC Draft Rules will be enacted. Given that (i) it is uncertain whether the CSRC Draft Rules will take effect as currently drafted and whether an issuer like YS Biopharma that has already submitted an listing application for the Business Combination to overseas regulators but have not yet completed the offering will be subject to the filing requirements therein, despite what the Q&A may indicate otherwise; and (ii) PRC governmental authorities have significant discretion in interpreting and implementing statutory provisions and there remains significant uncertainty in the interpretation and enforcement of the CSRC Draft Rules, YS Group cannot assure you that it will not be required to comply with the filing requirements under the CSRC Draft Rules if

the CSRC Draft Rules are adopted into law in the future or if the PRC regulatory authorities take a position contrary to ours. If YS Biopharma is required to comply with the filing requirements under the CSRC Draft Rules (if enacted), it is uncertain whether YS Biopharma can, or how long it will take YS Biopharma to, complete such filing procedures. Failure to comply with the filing requirements or any other requirements under the CSRC Draft Rules (if enacted) could result in warnings, a fine ranging from RMB1 million to RMB10 million, suspension of certain business operations, orders of rectification and revocation of business license.

If YS Biopharma fails to receive or maintain any requisite permission or approval from the CSRC for the Business Combination or future offerings, or the waiver for such permission or approval, in a timely manner, or at all, or inadvertently conclude that such permission or approval is not required, or if applicable laws, regulations or interpretations change and obligate YS Biopharma to obtain such permission or approvals in the future, YS Biopharma may be subject to fines and penalties (the details of which are unknown at this point), limitations on YS Group's business activities in China, delay or restrictions on the contribution of the proceeds from the Business Combination into the PRC, or other sanctions that could have a material adverse effect on YS Group's business, financial condition, results of operations, reputation and prospects. The CSRC may also take actions requiring or YS Group or making it advisable for or YS Group to halt the Business Combination or future offerings. Such uncertainties and/or negative publicity regarding such approval requirements could cause YS Biopharma's securities to decline significantly in value or become worthless.

Moreover, on November 14, 2021, the CAC released the Regulations for the Administration of Network Data Security (Draft for Comment), or the Draft Administrative Regulation. Under the Draft Administrative Regulation, (i) data processors, i.e., individuals and organizations who can decide on the purpose and method of their data processing activities at their own discretion, that process personal information of more than one million individuals shall apply for cybersecurity review before listing in a foreign country; (ii) foreign-listed data processors shall carry out annual data security evaluation and submit the evaluation report to the municipal cyberspace administration authority; and (iii) where the data processor undergoes merger, reorganization and subdivision that involves important data and personal information of more than one million individuals, the recipient of the data shall report the transaction to the in-charge authority at the municipal level. The public comment period for the Draft Administrative Regulation ended on December 13, 2021, and the Draft Administrative Regulation has not come into effect as of the date of this proxy statement/prospectus. On December 28, 2021, the PRC government promulgated the 2022 Cybersecurity Review Measures, which came into effect on February 15, 2022. According to the 2022 Cybersecurity Review Measures, (i) critical information infrastructure operators that purchase network products and services and internet platform operators that conduct data processing activities shall be subject to cybersecurity review in accordance with the 2022 Cybersecurity Review Measures if such activities affect or may affect national security; and (ii) internet platform operators holding personal information of more than one million users and seeking to have their securities list on a stock exchange in a foreign country shall file for cybersecurity review with the Cybersecurity Review Office. As of the date of this proxy statement/prospectus, neither YS Group/YS Biopharma nor any of its subsidiaries has been required by any PRC governmental authority to apply for cybersecurity review, nor have they received any inquiry, notice, warning, sanction in such respect or been denied permission from any PRC regulatory authority to list on U.S. exchanges. Based on the opinion of YS Biopharma's PRC counsel, Jingtian & Gongcheng, according to its interpretation of the currently in-effect PRC laws and regulations, YS Group believes that it is not subject to the cybersecurity review, reporting or other permission requirements by the CAC under the applicable PRC cybersecurity laws and regulations with respect to the offering of YS Biopharma's securities for the Business Combination or the business operations of YS Group's PRC subsidiaries, because YS Group/YS Biopharma or its PRC subsidiaries does not qualify as a critical information infrastructure operator or internet platform operator, or has conducted any data processing activities that affect or may affect national security or holds personal information of more than one million users. However, as PRC governmental authorities have significant discretion in interpreting and implementing statutory provisions and there remains significant uncertainty in the interpretation and enforcement of relevant PRC cybersecurity laws and regulations, if the PRC regulatory authorities take a position contrary to ours, YS Group cannot assure you that the Business Combination and business operation of YS Group/YS Biopharma or any of its PRC Subsidiaries will not be deemed to be subject to PRC cybersecurity review requirements under the 2022 Cybersecurity Review Measures or the Draft Administrative Regulations (if enacted) as a critical information infrastructure operator, data processor or an internet platform operator that is engaged in data processing activities that affect or may affect national security or

holds personal information of more than one million users, nor can YS Group assure you that YS Group/YS Biopharma or its PRC Subsidiaries would be able to pass such review. If YS Group/YS Biopharma or its PRC subsidiaries fail to receive any requisite permission or approval from the CAC for the Business Combination or the business operations of YS Group, or the waiver for such permission or approval, in a timely manner, or at all, or inadvertently conclude that such permission or approval is not required, or if applicable laws, regulations or interpretations change and obligate YS Group to obtain such permission or approvals, the completion of the Business Combination may be delayed or suspended, and YS Group may be subject to fines, suspension of business, website closure, revocation of business licenses or other penalties, as well as reputational damage or legal proceedings or actions against YS Group, which may have a material adverse effect on the business, financial condition or results of operations of YS Group. Any of the foregoing events may also significantly limit or completely hinder YS Biopharma's ability to offer or continue to offer securities to investors and cause the value of such securities to significantly decline or in extreme cases, become worthless. In addition, YS Group could become subject to enhanced cybersecurity review or investigations launched by PRC regulators in the future pursuant to new laws, regulations or policies. Any failure or delay in the completion of the cybersecurity review procedures or any other non-compliance with applicable laws and regulations may result in fines, suspension of business, website closure, revocation of business licenses or other penalties, as well as reputational damage or legal proceedings or actions against YS Group, which may have a material adverse effect on the business, financial condition or results of operations of YS Group.

***YS Biopharma's securities may be delisted under the Holding Foreign Companies Accountable Act if the PCAOB is unable to inspect auditors with presence in China in 2023 and beyond, and the delisting of its securities, or the threat of their being delisted, may materially and adversely affect the value of your investment.***

The Holding Foreign Companies Accountable Act ("HFCAA") was enacted on December 18, 2020. The HFCAA states if the SEC determines that a U.S. listed company has filed audit reports issued by a registered public accounting firm that has not been subject to inspection by the PCAOB for two consecutive years beginning in 2021, the SEC shall prohibit its securities from being traded on a national securities exchange or in the over the counter trading market in the United States.

YS Biopharma's consolidated financial statements contained in this registration statement on Form F-4, of which this proxy statement/prospectus forms a part, have been audited by WWC, an independent registered public accounting firm that is headquartered in the United States. WWC is a firm registered with the PCAOB, and is required by the United States laws to undergo regular inspections by the PCAOB to assess its compliance with the laws of the U.S. and professional standards. While WWC has been inspected by the PCAOB on a regular basis, no overseas securities regulator is allowed to directly conduct investigation or evidence collection activities in China according to Article 177 of the PRC Securities Law (last amended in December 2019). Accordingly, without the consent of the competent PRC securities regulators and relevant securities business activities in China to the PCAOB, an overseas securities regulator under the PRC Securities Law. As a result, the audit working papers of the financial statements in this proxy statement/prospectus may not be inspected by the PCAOB, since the audit work was carried out by WWC with the collaboration of their China-based offices and the PCAOB has not obtained such requisite approval. The trading of YS Biopharma's securities may be prohibited and such securities may be delisted from Nasdaq or any other U.S. stock exchange under the HFCAA if the PCAOB is unable to inspect auditors with presence in China. The prohibition of trading of YS Biopharma's securities and the delisting of the securities, or the threat of their being prohibited or delisted, may cause the value of such securities to significantly decline or, in extreme cases, become worthless.

On March 24, 2021, the SEC adopted interim final rules relating to the implementation of certain disclosure and documentation requirements of the HFCAA. On December 2, 2021, the SEC adopted amendments to finalize such rules, which include requirements to disclose information, including the auditor name and location, the percentage of shares of the issuer owned by governmental entities, whether governmental entities in the applicable foreign jurisdiction with respect to the auditor has a controlling financial interest with respect to the issuer, the name of each official of the Chinese Communist Party who is a member of the board of the issuer, and whether the articles of incorporation of the issuer contains any charter of the Chinese Communist Party. These amendments also establish procedures the SEC will follow in identifying issuers and prohibiting trading by certain issuers under the HFCAA, including that the SEC will identify an issuer as a "Commission-identified Issuer" if the issuer has filed an annual report containing an audit report issued by a registered

public accounting firm that the PCAOB has determined it is unable to inspect or investigate completely, and will then impose a trading prohibition on an issuer after it is identified as a Commission-Identified Issuer for two consecutive years.

On December 16, 2021, the PCAOB issued a report to notify the SEC of its determination that it is unable to inspect or investigate completely PCAOB-registered public accounting firms headquartered in mainland China and Hong Kong without the approval of the Chinese authorities. While YS Biopharma's auditor, Wei, Wei & Co., LLP, is headquartered in the United States and not subject to such determinations, there is no guarantee that the audit work carried out by Wei, Wei & Co., LLP in collaboration of its China-based offices can be inspected or investigated completely by the PCAOB without such approval. Following the consummation of the Business Combination, YS Biopharma will be required to comply with these rules if the SEC identifies YS Biopharma as having a "non-inspection" year by evaluating the annual report it files, in which it will identify the auditor who provide opinions related to the financial statements presented in its annual report, the location where the auditor's report has been issued and the PCAOB ID number of such audit firm or branch. If YS Biopharma has two consecutive non-inspection years, the SEC will implement the trading prohibition of YS Biopharma's securities through stop orders, and the exact timeline for when the SEC will delist an issuer after two consecutive non-inspection years remains imprecise. YS Biopharma's securities could be prohibited from trading in the United States if it is identified as a Commission-identified Issuer for two consecutive years.

In March 2022, the SEC issued its first "conclusive list of issuers identified under the HFCAA" indicating that those companies are now formally subject to the delisting provisions if they remain on the list for two consecutive years. As of the date of this proxy statement/prospectus, more than 170 public companies were listed in as issuers identified under the HFCAA.

In August 2022, the PCAOB, the CSRC and the Ministry of Finance of the PRC signed the Statement of Protocol, which establishes a specific and accountable framework for the PCAOB to conduct inspections and investigations of PCAOB-governed accounting firms in mainland China and Hong Kong. On December 15, 2022, the PCAOB announced that it was able to secure complete access to inspect and investigate PCAOB registered public accounting firms headquartered in mainland China and Hong Kong completely in 2022. The PCAOB Board vacated its previous 2021 determinations that the PCAOB was unable to inspect or investigate completely registered public accounting firms headquartered in mainland China and Hong Kong. However, whether the PCAOB will continue to be able to satisfactorily conduct inspections of PCAOB-registered public accounting firms headquartered in mainland China and Hong Kong is subject to uncertainties and depends on a number of factors out of our and our auditor's control. The PCAOB continues to demand complete access in mainland China and Hong Kong moving forward and is making plans to resume regular inspections in early 2023 and beyond, as well as to continue pursuing ongoing investigations and initiate new investigations as needed. The PCAOB has also indicated that it will act immediately to consider the need to issue new determinations with the HFCAA if needed.

The HFCAA or other efforts to increase U.S. regulatory access to audit information could cause investor uncertainty for affected issuers, including YS Biopharma, and the market price of YS Biopharma's securities could be adversely affected. If its auditor is unable to be inspected or it is unable to meet the PCAOB inspection requirement in time in 2023 and beyond, including retain a registered public accounting firm that the PCAOB is able to inspect, YS Biopharma would be identified as a "Commission-identified Issuer" and be delisted from the Nasdaq Stock Market upon the expiration of the applicable years of non-inspection under the HFCAA and YS Biopharma's securities will not be permitted for trading "over-the-counter" either. If YS Biopharma's securities are prohibited from trading in the United States, there is no certainty that YS Group will be able to list on a non-U.S. exchange or that a market for its shares will develop outside of the United States. Such a delisting would substantially impair your ability to sell or purchase YS Biopharma's securities when you wish to do so, and the risk and uncertainty associated with delisting would have a negative impact on the price of YS Biopharma's securities. Also, such a delisting would significantly affect YS Biopharma's ability to raise capital on terms acceptable to it, or at all, which would have a material adverse impact on its business, financial condition, and prospects. If YS Biopharma's securities are delisted from Nasdaq Stock Market and are prohibited from trading in the over-the-counter market in the United States, there is no certainty that YS Biopharma will be able to list on a non-U.S. exchange or that a market for YS Biopharma's securities will develop outside of the United States.

***PRC governmental authorities' significant oversight and discretion over YS Group's business operation could result in a material adverse change in its operations following the Business Combination and the value of YS Biopharma's securities and YS Biopharma's securities following the Business Combination.***

PRC governmental authorities have significant oversight and discretion over YS Group's business operations in China and may seek to intervene or influence such operations at any time that the government deems appropriate to further its regulatory, political and societal goals, which could result in a material adverse change in its operations and/or the value of YS Biopharma's securities. In addition, the PRC governmental authorities may also exert more oversight and control over offerings that are conducted overseas and/or foreign investment in China-based issuers. Any such action could result in a material change in YS Group's operations, significantly limit or completely hinder the value of YS Biopharma's securities and the ability of YS Biopharma to offer or continue to offer securities to investors, and cause the value of such securities to significantly decline or be worthless. Furthermore, the implementation of industry-wide regulations directly targeting the operations of YS Group could cause the value of YS Biopharma's securities and YS Biopharma's securities to significantly decline.

***Changes in China's economic, political or social conditions or government policies could have a material adverse effect on YS Group's business and operations.***

YS Group has conducted a substantial portion of its business in China, including, among others, manufacturing and sales of YSJA<sup>TM</sup> rabies vaccines and certain research and development activities. As such, YS Group's business, financial condition, results of operations and prospects may be influenced to a significant degree by political, economic and social conditions in China, including, among others, overall economic growth, level of urbanization and level of per capita disposable income. The Chinese economy differs from the economies of most developed countries in many respects, including the level of government involvement, level of development, growth rate, control of foreign exchange and allocation of resources. Although the Chinese government has implemented various changes, a significant portion of the productive assets in China are owned by the government, and the Chinese government continues to play a significant role in regulating industry development by setting industrial policies. The Chinese government also exercises significant control over China's economic growth by allocating resources, controlling payment of foreign currency-denominated obligations, setting monetary policy and providing different treatment to particular industries or companies.

While the Chinese economy has experienced significant growth over past decades, growth has been uneven, both geographically and among various sectors of the economy. Any adverse changes in economic conditions in China, the policies of the Chinese government or the laws and regulations in China could have a material adverse effect on the overall economic growth of China. Such developments may lead to a reduction in demand for YS Group's marketed product or product candidates in the future and materially and adversely affect its business, financial condition and results of operations. In addition, stimulus measures designed to boost the Chinese economy may contribute to higher inflation, which could adversely affect YS Group's results of operations and financial condition.

***A severe or prolonged downturn in the PRC or global economy and political tensions between the United States and China could materially and adversely affect YS Group's business and financial condition.***

The global macroeconomic environment is facing challenges, including the end of quantitative easing by the U.S. Federal Reserve, the economic slowdown in the Eurozone since 2014 and uncertainties over the impact of Brexit. The Chinese economy has shown slower growth compared to the previous decade since 2012 and the trend may continue. There is considerable uncertainty over the long-term effects of the expansionary monetary and fiscal policies adopted by the central banks and financial authorities of some of the world's leading economies, including the United States and China. There have been concerns over unrest and terrorist threats in the Middle East, Europe and Africa, which have resulted in market volatility.

If YS Group plans to expand its business internationally and does business cross-border in the future, any unfavorable government policies on international trade, such as capital controls or tariffs, may affect the demand for its products and product candidates, impact its competitive position, or prevent it from being able to conduct business in certain countries. If any new tariffs, legislation, or regulations are implemented, or if existing trade agreements are renegotiated, such changes could adversely affect YS Group's business, financial condition, and results of operations. In particular, there have been heightened tensions in international



economic relations between the United States and China. The U.S. government has recently imposed, and has recently proposed to impose additional, new, or higher tariffs on certain products imported from China to penalize China for what the U.S. government characterizes as unfair trade practices. China has responded by imposing, and proposing to impose additional, new, or higher tariffs on certain products imported from the United States. Following mutual retaliatory actions for months, on January 15, 2020, the United States and China entered into the Economic and Trade Agreement Between the United States of America and the People's Republic of China as a phase one trade deal, effective on February 14, 2020. Although the direct impact of the current international trade tension, and any escalation of such tension, on the holographic technology industry in China is uncertain, the negative impact on general, economic, political and social conditions may adversely impact YS Group's business, financial condition and results of operations.

***YS Group's business operations are subject to various PRC laws and regulations, the interpretation and enforcement of which involve significant uncertainties as the PRC legal system is evolving rapidly.***

The PRC legal system is a civil-law system based on written statutes. Unlike the common-law system, prior court decisions under the civil-law system may be cited for reference but have limited precedential value, which has led to uncertainty and inconsistency in the interpretation and enforcement of many laws. Uncertainties also exist with respect to new legislation or proposed changes in the PRC regulatory requirements as the PRC legal system is evolving rapidly. The interpretations of many laws and regulations may contain inconsistencies, and the enforcement of these laws, regulations and rules involves uncertainties. In addition, laws and regulations can change quickly with limited advance notice. From time to time, YS Group may have to resort to administrative and court proceedings to enforce their legal rights. Because PRC administrative and court authorities have significant discretion in interpreting and implementing statutory provisions and contractual terms, it may be difficult to evaluate the outcome of administrative and court proceedings and the level of legal protection they enjoy. Such uncertainty towards their contractual, property and procedural rights and legal obligations could adversely affect their business and impede their ability to grow their business. In addition, the regulatory uncertainties may be exploited through unmerited or frivolous legal actions or threats in attempts to extract payments or benefits from them.

***PRC regulations relating to offshore investment activities by PRC residents may subject YS Biopharma's PRC resident shareholders, beneficial owners and PRC subsidiaries to liability or penalties, limit their ability to inject capital into its PRC subsidiaries, limit its PRC subsidiaries' ability to increase their registered capital or distribute profits to YS Group or otherwise adversely affect it.***

In July 2014, the SAFE promulgated the Circular on Relevant Issues Concerning Foreign Exchange Control on Domestic Residents' Offshore Investment and Financing and Roundtrip Investment Through Special Purpose Vehicles ("SAFE Circular 37"). SAFE Circular 37 requires PRC residents (including PRC individuals and PRC corporate entities, as well as foreign individuals that are deemed PRC residents for foreign exchange administration purposes) to register with the SAFE or its local branches in connection with their direct or indirect offshore investment activities. SAFE Circular 37 further requires the SAFE registrations be updated in the event of any changes with respect to the basic information of the offshore special purpose vehicle, such as a change in its name, operation term and PRC resident shareholder, an increase or decrease of capital contribution, share transfer or exchange by PRC resident individuals, or mergers or divisions.

In September 2014, MOFCOM promulgated the Measures for the Administration of Overseas Investment. In December 2017, the NDRC further promulgated the Administrative Measures of Overseas Investment of Enterprises, which became effective in March 2018. Pursuant to these regulations, any outbound investment of PRC enterprises in a non-sensitive area or industry is required to be filed with the MOFCOM and the NDRC or their local branches.

YS Biopharma has requested that all of its current shareholders and beneficial owners who, to their and YS Biopharma's knowledge, are PRC residents complete the foreign exchange registrations and that those who, to their and YS Biopharma's knowledge, are PRC enterprises comply with outbound investment related regulations. However, YS Biopharma may not be informed of the identities of all the PRC residents and PRC enterprises holding direct or indirect interest in YS Biopharma, and they and YS Biopharma cannot provide any assurance that these PRC residents and PRC enterprises will comply with their and YS Biopharma's request to make or obtain the applicable registrations or continuously comply with all the requirements under

SAFE Circular 37 or other related rules and the outbound investment related regulations. Failure by such shareholders or beneficial owners to comply with SAFE and outbound investment related regulations, or failure by YS Biopharma to amend the foreign exchange registrations of its PRC subsidiaries, could subject YS Biopharma to fines or legal sanctions, restrict its overseas or cross-border investment activities, limit the YS Biopharma's PRC subsidiaries' ability to make distributions or pay dividends to YS Biopharma or affect its ownership structure, which could adversely affect its business and prospects.

Furthermore, as these foreign exchange and outbound investment related regulations are relatively new and their interpretation and implementation have been constantly evolving, it is uncertain how these regulations, and any future regulations concerning offshore or cross-border investments and transactions, will be interpreted, amended and implemented by the relevant government authorities. For example, YS Biopharma may be subject to a more stringent review and approval process with respect to its foreign exchange activities, such as remittance of dividends and foreign-currency-denominated borrowings, which may adversely affect YS Biopharma's financial condition and results of operations. Due to the complexity and constantly changing nature of the regulations related to foreign exchange and outbound investment, as well as the uncertainties involved, YS Biopharma cannot assure you that it has complied or will be able to comply with all applicable foreign exchange and outbound investment related regulations. In addition, if YS Group decides to acquire a PRC domestic company, YS Group cannot assure you that it or the owners of such company, as the case may be, will be able to obtain the necessary approvals or complete the necessary filings and registrations required by the foreign exchange regulations. This may restrict YS Biopharma's ability to implement YS Group's acquisition strategy and could adversely affect its business and prospects.

***YS Group's PRC subsidiaries are subject to restrictions on paying dividends or making other payments to its offshore holding companies, including the YS Biopharma, which may restrict their ability to satisfy liquidity requirements.***

YS Biopharma is a holding company incorporated in the Cayman Islands. Payment of dividends by YS Group's PRC subsidiaries is an important source of support for YS Biopharma to meet their financing needs, and such payment is subject to various restrictions. Current PRC regulations permit the PRC subsidiaries to pay dividends to their offshore holding companies only out of their accumulated after-tax profits upon satisfaction of relevant statutory condition and procedures, if any, determined in accordance with Chinese accounting standards and regulations. In addition, each of YS Group's PRC subsidiaries is required to set aside at least 10% of its after-tax profits each year, if any, to fund certain reserve funds until the total amount set aside reaches 50% of its registered capital. In addition, the PRC Enterprise Income Tax Law and its implementation rules provide that withholding tax at the rate of 10% will be applicable to dividends payable by Chinese companies to non-PRC-resident enterprises, unless otherwise exempted or reduced according to treaties or arrangements between the PRC central government and governments of other countries or regions where the non-PRC-resident enterprises are incorporated. Furthermore, if YS Group's PRC subsidiaries incur debt on their own behalf in the future, the instruments governing the debt may restrict their ability to pay dividends or make other payments to YS Group which may restrict their offshore holding companies' ability to satisfy YS Group's liquidity requirements.

***Fluctuations in exchange rates could have a material and adverse effect on the value of your investment and YS Biopharma's results of operations.***

The value of the Renminbi against the U.S. dollar and other currencies may fluctuate and is affected by, among other things, changes in the political and economic conditions in China and China's foreign exchange policies. On July 21, 2005, the PRC government changed its decade-old policy of pegging the value of the Renminbi to the U.S. dollar. On November 30, 2015, the Executive Board of the International Monetary Fund (IMF) completed the regular five-year review of the basket of currencies that make up the Special Drawing Right (the "SDR") and decided that, from October 1, 2016, Renminbi would be determined to be a freely usable currency and will be included in the SDR basket. Since June 2010, the Renminbi has fluctuated significantly against the U.S. dollar. It is difficult to predict how market forces or policies by the PRC or U.S. government may impact the exchange rate between the Renminbi and the U.S. dollar in the future. With the development of the foreign exchange market and progress towards interest rate liberalization and Renminbi internationalization, the PRC government may in the future announce further changes to the exchange rate

system, and YS Group cannot assure you that the Renminbi will not appreciate or depreciate significantly in value against the U.S. dollar in the future.

Significant revaluation of the Renminbi may materially and adversely affect the revenues, earnings and financial position of YS Group, and the value and trading price of, and any dividends payable on, YS Biopharma's securities in U.S. dollars. The appreciation of the Renminbi against the U.S. dollar would have an adverse effect on the Renminbi amount that would be received from the conversion to the extent that needs to be converted U.S. dollars into Renminbi for capital expenditures and working capital and other business purposes. Conversely, a significant depreciation of the Renminbi against the U.S. dollar may significantly reduce the U.S. dollar equivalent of the earnings, which in turn could adversely affect the price of YS Biopharma's securities and have a negative effect on the U.S. dollar amount available to YS Group for the purpose of making payments for dividends on YS Biopharma's securities, royalties, strategic acquisitions or investments or for other business purposes.

Very limited hedging options are available in China to reduce YS Group's exposure to exchange rate fluctuations. To date, no hedging transactions in an effort to reduce the exposure of YS Group or YS Biopharma to foreign currency exchange risk was contracted. While YS Group may decide to enter into hedging transactions in the future, the availability and effectiveness of these transactions may be limited, and YS Group may not be able to adequately hedge the exposure, or at all. In addition, YS Group's currency exchange losses may be magnified by PRC exchange control regulations that restrict its ability to convert Renminbi into foreign currency.

***PRC regulation of loans to and direct investment in PRC entities by offshore holding companies and governmental control of currency conversion may restrict or delay YS Biopharma from using the offshore proceeds to make loans or additional capital contributions to its PRC subsidiaries, which could adversely affect its liquidity and ability to fund and expand its business.***

Under PRC laws and regulations, loans by YS Biopharma to its PRC subsidiaries to finance their operations shall not exceed certain statutory limits and must be registered with the local counterpart of the SAFE, and any capital contribution from YS Biopharma or YS Biopharma to its PRC subsidiaries is required to be registered, filed with or reported to the competent PRC governmental authorities. Currently, there is no statutory limit to the amount of funding that it can provide to YS Group's PRC subsidiaries through capital contributions, because there is no statutory limit on the amount of registered capital for its PRC subsidiaries and it is allowed to make capital contributions to its PRC subsidiaries by subscribing for their registered capital, provided that the PRC subsidiaries complete the relevant filing, registration and reporting procedures. According to relevant PRC regulations on foreign-invested enterprises, capital contributions to the relevant PRC subsidiaries are required to be registered with SAMR or its local counterpart and a local bank authorized by the SAFE, and reported to MOFCOM's local counterpart.

***Foreign exchange controls may limit YS Group's ability to effectively utilize its revenues and proceeds generated or financed outside China and adversely affect the value of your investment.***

The PRC government imposes foreign exchange controls on the convertibility of the Renminbi and, in certain cases, the remittance of currency out of China. YS Group receives substantially all of its revenues in Renminbi. Under the proposed corporate structure following the Business Combination, YS Biopharma, which is YS Group's Cayman Islands holding company primarily relies on dividend payments from its PRC subsidiaries to fund any cash and financing requirements it may have. Under the existing exchange restrictions, without prior approval of the SAFE, cash generated from the operations of PRC subsidiaries in China may be used to pay dividends to YS Biopharma. However, approval from or registration with appropriate government authorities is required where Renminbi is to be converted into foreign currency and remitted out of mainland China to pay capital expenses, such as the repayment of loans denominated in foreign currencies. As a result, YS Biopharma needs to obtain requisite approval or registration to use cash generated from the operations of its PRC subsidiaries to pay off their respective debt in a currency other than Renminbi owed to entities outside China, or to make other capital expenditure payments outside China in a currency other than Renminbi. The PRC government may also at its discretion restrict access to foreign currencies for current account transactions in the future. If the foreign exchange control system prevents YS Group from obtaining sufficient foreign currencies to satisfy its foreign currency demands, YS Biopharma may not be able to pay dividends to you or

fulfill other payment obligations in foreign currencies or fund any future operations that it may have outside of mainland China with foreign currencies.

In addition, under the Circular on Reforming the Management Approach Regarding the Foreign Exchange Capital Settlement of Foreign-Invested Enterprises (“FIEs”) and the Notice of the State Administration of Foreign Exchange on Reforming and Standardizing the Foreign Exchange Settlement Management Policy of Capital Account, FIEs are prohibited from using Renminbi funds converted from their foreign exchange capital for expenditures beyond their business scopes or using such Renminbi funds to provide loans to persons other than their affiliates, unless within their business scope.

Any foreign loan procured by YS Group’s PRC subsidiaries is also required to be registered with the SAFE or its local branches or be filed with the SAFE in its information system, and each of YS Group’s PRC subsidiaries may not procure loans which exceed either (i) the amount of the difference between their respective registered total investment amount and registered capital or (ii) two and a half times, or the then-applicable statutory multiple, the amount of their respective audited net assets, calculated in accordance with PRC GAAP (the “Net Assets Limit”), at YS Group’s election. Increasing the amount of the difference between their respective registered total investment amount and registered capital of the PRC subsidiaries might be subject to governmental approval and may require a PRC subsidiary to increase its registered capital at the same time. If YS Group makes a loan to a PRC entity based on its Net Assets Limit, the maximum amount that the offshore companies would be able to loan to the relevant PRC entity would depend on the relevant entity’s net assets and the applicable statutory multiple at the time of the calculation. As of the date of this proxy statement/prospectus, all of YS Group’s PRC subsidiaries have negative or very limited net assets, which prevents them from providing loans to them using the Net Assets Limit. Any medium- or long-term loan to be provided by YS Group or a foreign third party to the PRC subsidiaries must also be registered by and filed with the NDRC.

On October 23, 2019, SAFE further issued the Circular of the State Administration of Foreign Exchange on Further Promoting the Facilitation of Cross-Border Trade and Investment (“Circular 28”), which took effect on the same day. Circular 28 allows non-investment FIEs to use their capital funds to make equity investments in China as long as such investments do not violate the then effective negative list for foreign investments and the target investment projects are genuine and in compliance with laws. In addition, Circular 28 stipulates that qualified enterprises in certain pilot areas may use their capital income from registered capital, foreign debt and overseas listing, for the purpose of domestic payments without providing authenticity certifications to the relevant banks in advance for those domestic payments. As this circular is relatively new, there remains uncertainty as to its interpretation and application and any other future foreign exchange-related rules. Violations of these circulars could result in severe monetary or other penalties.

These PRC laws and regulations may significantly limit YS Biopharma’s ability to use Renminbi converted from the proceeds received outside China to fund the establishment of new entities in China by its PRC subsidiaries, and to invest in or acquire any other PRC companies through its PRC subsidiaries. Moreover, YS Group cannot assure you that it will be able to complete the necessary registrations or obtain the necessary government approvals on a timely basis, if at all, with respect to future loans to its PRC subsidiaries, or future capital contributions by YS Group to its PRC subsidiaries. If it fails to complete such registrations or obtain such approvals or if it is found to be in violation of any applicable laws with respect to foreign currency exchange, its ability to use the proceeds it received or expect to receive from YS Group’s offshore offerings may be negatively affected and it may be subject to penalties, which could materially and adversely affect its liquidity and its ability to fund and expand its business.

***The M&A Rules and certain other PRC regulations could make it more difficult for YS Group to pursue growth through acquisitions in China.***

In China, the M&A Rules, established additional procedures and requirements that could make merger and acquisition activities involving the PRC by foreign investors more time-consuming and complex, including requirements in some instances that the in-charge government authority be notified and relevant approval shall be obtained in advance of any change-of-control transaction in which a foreign investor takes control of a PRC domestic enterprise. Moreover, the Anti-monopoly Law of the PRC requires that the in-charge government authority be notified in advance of any concentration of undertaking if certain thresholds are triggered. In light of the uncertainties relating to the interpretation, implementation and enforcement of the

Anti-monopoly Law, YS Group cannot assure you that the in-charge Anti-monopoly Law enforcement agency will not deem YS Group's past acquisition or investments to have triggered the filing requirement for anti-trust review. If YS Group is found to have violated the Anti-monopoly Law for failing to file the notification of concentration and request for review, it could be, among others, subject to a fine of up to RMB5,000,000 if the concentration has no effect of eliminating the restricting competition, or a fine of not more than 10% of its sales amount in the previous year if the concentration has or may have the effect of eliminating or restricting competition, and the parts of the transaction causing the prohibited concentration could be ordered to be unwound, which may materially and adversely affect its business, financial condition and results of operations. In addition, under applicable laws, mergers and acquisitions by foreign investors that raise "national defense and security" concerns and mergers and acquisitions through which foreign investors may acquire de facto control over domestic enterprises that raise "national security" concerns are subject to strict review by the MOFCOM, and any activities attempting to bypass a security review, including by structuring the transaction through a proxy or contractual control arrangement, are prohibited.

In the future, YS Group or YS Biopharma may grow its business by acquiring complementary businesses. Complying with the requirements of the above-mentioned regulations and other relevant rules to complete such transactions could be time-consuming, and any required approval processes, including obtaining approval from the MOFCOM or its local counterparts, may delay or inhibit its ability to complete such transactions, which could affect its ability to expand its business or maintain YS Group's market share.

***Failure to comply with PRC regulations regarding the registration requirements for employee stock ownership plans or share option plans may subject the PRC plan participants or YS Biopharma to fines and other legal or administrative sanctions.***

Upon consummation of the Business Combination, YS Biopharma will assume the share incentive plan of YS Group and the outstanding awards. Pursuant to the Notice on Issues Concerning the Foreign Exchange Administration for Domestic Individuals Participating in Stock Incentive Plan of Overseas Publicly Listed Company, promulgated by the SAFE in 2012, grantees of YS Biopharma's incentive share awards who are PRC citizens or who are non-PRC residents continuously residing in the PRC for a continuous period of no less than a year (excluding the foreign diplomatic personnel and representatives of international organizations) are required to register with the SAFE and complete certain other procedures through a domestic qualified agent and collectively retain an overseas entrusted institution to handle matters related to the exercise of stock options and the purchase and disposition of related equity interests after YS Biopharma becomes an overseas listed company upon the completion of the Business Combination. Failure to comply with these SAFE requirements may subject these individuals to fines and legal sanctions and may also limit the ability of YS Biopharma to contribute additional capital into its PRC subsidiaries and limit its PRC subsidiaries' ability to distribute dividends to YS Biopharma.

The SAT, has also issued certain circulars concerning equity incentive awards. Under these circulars, YS Group's employees working in China who exercise share options or are granted restricted share units will be subject to PRC individual income tax. If YS Group's employees fail to pay or if YS Group fails to withhold their income taxes according to relevant laws and regulations, YS Group may face sanctions imposed by the tax authorities or other PRC governmental authorities.

***Your ability to effect service of legal process, enforce judgments or bring actions against YS Biopharma, Summit or certain of their officers and directors outside the U.S. will be limited and additional costs may be required.***

Each of YS Biopharma, YS Biopharma and Summit is a Cayman Islands holding company that conducts its operations outside the United States. A majority of the YS Biopharma's officers and a minority of YS Biopharma's directors reside outside the United States, and a substantial portion of the assets of those persons are located outside of the United States. For example, certain YS Biopharma's directors and officers reside in mainland China and one independent director of YS Biopharma resides in Hong Kong. In addition, a majority of Summit's officers and directors are reside in mainland China and Hong Kong. Therefore, it may be difficult or costly for you to effect service of process against YS Biopharma, YS Biopharma, Summit or their officers and directors within the U.S. In addition, YS Biopharma has been advised by its PRC legal counsel that it is uncertain (i) whether and on what basis a PRC court would enforce judgment rendered by a court in the U.S. based upon the civil liability provisions of U.S. federal securities laws; and (ii) whether an

investor will be able to bring an original action in a PRC court based on U.S. federal securities laws. In addition, China does not have treaties providing for the reciprocal recognition and enforcement of judgments of courts with the Cayman Islands and many other countries and regions. As such, you may not be able to or may experience difficulties or incur additional costs in order to enforce judgments obtained in U.S. courts based upon the civil liability provisions of U.S. federal securities laws in China or bring original actions in China based on U.S. federal securities laws even if you are successful in bringing an action of this kind. Furthermore, any judgment obtained in the U.S. against YS Group, Summit and these individuals may not be collectible within the U.S.

***You may face difficulties in protecting your interests, and your ability to protect your rights through U.S. courts may be limited, because each of Summit and YS Biopharma is incorporated under the law of the Cayman Islands, the YS Biopharma conducts substantially all of its operations and a majority of their respective directors and executive officers reside outside of the United States.***

Each of Summit and YS Biopharma is an exempted company limited by shares incorporated under the laws of the Cayman Islands, and following the Business Combination, YS Biopharma will continue to conduct a majority of its operations through its subsidiaries, namely YS GROUP BIOPHARMA (SINGAPORE) PTE. LTD., Liaoning Yisheng and Beijing Yisheng, outside the United States. Substantially all of the YS Biopharma's assets are located outside of the United States. A majority of the YS Biopharma's officers and a minority of YS Biopharma's directors reside outside the United States and a substantial portion of the assets of those persons are located outside of the United States, including, among others, certain YS Biopharma's directors and officers reside in mainland China and one independent director of YS Biopharma resides in Hong Kong. In addition, a majority of Summit's officers and directors are reside in mainland China and Hong Kong. As a result, it could be difficult or impossible for you to bring an action against the YS Biopharma or Summit or against these individuals outside of the United States in the event that you believe that your rights have been infringed upon under the applicable securities laws or otherwise. Even if you are successful in bringing an action of this kind, the laws of the Cayman Islands and of the PRC could render you unable to enforce a judgment against the relevant assets or the assets of the relevant directors and officers.

In addition, the YS Biopharma's corporate affairs will be governed by the Amended YS Biopharma Memorandum and Articles, the Cayman Islands Companies Act and the common law of the Cayman Islands. The rights of investors to take action against the directors, actions by minority shareholders and the fiduciary duties of the YS Biopharma's directors to the YS Biopharma under Cayman Islands law are to a large extent governed by the common law of the Cayman Islands. The common law of the Cayman Islands is derived in part from comparatively limited judicial precedent in the Cayman Islands as well as from the common law of England, the decisions of whose courts are of persuasive authority, but are not binding, on a court in the Cayman Islands. The rights of the YS Biopharma's shareholders and the fiduciary duties of the YS Biopharma's directors under Cayman Islands law may not be as clearly established as they would be under statutes or judicial precedent in some jurisdictions in the United States. In particular, the Cayman Islands has a different body of securities laws than the United States. Some U.S. states, such as Delaware, may have more fully developed and judicially interpreted bodies of corporate law than the Cayman Islands. In addition, Cayman Islands companies may not have standing to initiate a shareholder derivative action in a federal court of the United States.

Shareholders of Cayman Islands exempted companies like the YS Biopharma have no general rights under Cayman Islands law to inspect corporate records or to obtain copies of lists of shareholders of these companies (save for the memorandum and articles of association, the register of mortgages and charges, and special resolutions of YS Biopharma's shareholders). The YS Biopharma's directors will have discretion under the Amended YS Biopharma Memorandum and Articles to determine whether or not, and under what conditions, the YS Biopharma's corporate records may be inspected by its shareholders, but the YS Biopharma is not obliged to make them available to the shareholders. This may make it more difficult for you to obtain the information needed to establish any facts necessary for a shareholder's motion or to solicit proxies from other shareholders in connection with a proxy contest. See the section entitled "Description Of YS Biopharma Securities — Inspection of Books and Records."

Certain corporate governance practices in the Cayman Islands, which is the YS Biopharma's home country, differ significantly from requirements for companies incorporated in other jurisdictions such as the United

States. To the extent the YS Biopharma chooses to follow home country practice with respect to corporate governance matters, its shareholders may be afforded less protection than they otherwise would under rules and regulations applicable to U.S. domestic issuers. See the section entitled “Management of YS Biopharma Following the Business Combination — Foreign Private Issuer Status.”

As a result of all of the above, the YS Biopharma’s shareholders may have more difficulty in protecting their interests in the face of actions taken by management, members of the board of directors or controlling shareholders than they would as public shareholders of a company incorporated in the United States.

***Inflation in China and increase in labor costs could negatively affect the profitability and growth of YS Group.***

Economic growth in China has, in the past, been accompanied by periods of high inflation, and the PRC government has implemented various policies from time to time to control inflation, including imposing various corrective measures designed to restrict the availability of credit or regulate growth. High inflation in the future may cause the PRC government to once again impose controls on credit and/or price of commodities, or to take other actions, which could inhibit economic activities in China. Any action on the part of the PRC government that seeks to control credit and/or price of commodities may adversely affect the business operations of YS Group, causing negative impact on its profitability and growth.

Moreover, the significant economic growth in China has resulted in a general increase in labor costs and shortage of low-cost labor. Inflation may cause its production cost to continue to increase. If YS Group is unable to pass on the increase in production cost to its customers, it may suffer a decrease in profitability and a loss of customers, and YS Group’s results of operations could be materially and adversely affected. In addition, PRC entities have been subject to stricter regulatory requirements in terms of entering into labor contracts with their employees and paying various statutory employee benefits, including pensions, housing funds, medical insurance, work-related injury insurance, unemployment insurance and maternity insurance to designated government agencies for the benefit of their employees. Pursuant to the PRC Labor Contract Law and its implementation rules, employers are subject to stricter requirements in terms of signing labor contracts, minimum wages, overtime work, labor dispatch, paying remuneration, determining the term of employee’s probation and unilaterally terminating labor contracts. In the event that YS Group decides to terminate some of their employees or otherwise change their employment or labor practices, the PRC Labor Contract Law and its implementation rules may limit their ability to effect those changes in a desirable or cost-effective manner, which could adversely affect their business and results of operations. Also, YS Group needs to apply for flexible working hours arrangement and comprehensive working hours scheme with relevant PRC authorities and comply with the requirements contained in the relevant approvals, or pay employees overtime work compensations in case YS Group intends to ask its employees to work overtime. YS Group might not be able to, in a timely manner or at all, obtain relevant approvals and fully comply with requirements therein, or pay the overtime work compensation according to relevant regulations.

Pursuant to the PRC laws and regulations, companies registered and operating in China are required to apply for social insurance registration and housing fund deposit registration within 30 days of their establishment and to pay for their employees different social insurance and housing provident funds to the extent required by law. YS Group engaged third-party human resources agencies to pay social insurance and housing funds for certain employees for their actual needs to participate in local social insurance and housing fund schemes in their place of residency where YS Group did not have subsidiaries established. The contributions of social insurance premium and housing provident funds made through third-party accounts may not be recognized as contributions made by YS Group, and as a result, YS Group may be required by competent authorities to pay the outstanding amount, and could be subject to late payment fines and other penalties or enforcement application made to the court. See the section entitled “— YS Group may be subject to fines and penalties under applicable PRC laws and regulations for failure to make adequate contributions to social insurance and housing provident fund for its employees.” Recently, as the PRC government enhanced its enforcement measures relating to social insurance collection, it may be required to make up the contributions for YS Group’s employees, and may be further subjected to late fees payment and administrative fines, which may adversely affect its financial condition and results of operations.

As the interpretation and implementation of labor-related laws and regulations are still evolving, YS Group cannot assure you that YS Group’s employment practices has been and will be in compliance with labor-related laws and regulations in China in all material respects, which may subject it to labor disputes or

government investigations and penalties. In addition, it may incur additional expenses in order to comply with such laws and regulations, which may adversely affect its business and profitability.

***YS Biopharma may be deemed to be a PRC tax resident under the EIT Law following the consummation of the Business Combination, and as a result, their global income could be subject to PRC withholding tax and enterprise income tax.***

YS Biopharma is a holding company incorporated under the laws of the Cayman Islands and indirectly hold interests in a Hong Kong-incorporated subsidiary, which in turn hold interests in certain PRC subsidiaries following the consummation of the Business Combination. Pursuant to the EIT Law, effective in January 2008, as amended on lately December 29, 2018, and its implementation rules, dividends payable by a foreign-invested enterprise to its foreign corporate investors who are not deemed a PRC resident enterprise are subject to a 10.0% withholding tax, unless such foreign investor's jurisdiction of incorporation has a tax treaty with the PRC that provides for a different withholding tax arrangement. Under the Arrangement between the Mainland of China and Hong Kong Special Administration Region for the Avoidance of Double Taxation and the Prevention of Fiscal Evasion with Respect to Tax on Income (the "Tax Treaty") which was promulgated by SAT and the Hong Kong government on August 21, 2006, such dividend withholding tax rate is reduced to 5.0% for dividends paid by a PRC resident enterprise to a Hong Kong-resident enterprise if such Hong Kong entity is a "beneficial owner" and such entity directly owns at least 25.0% of the equity interest of the PRC company. The Announcement on Issues Relating to "Beneficial Owner" in Tax Treaties, effective in April 2018, provides certain factors for the determination of "beneficial owner" status of a company under the Tax Treaty. If the PRC tax authorities determine that YS Group's Hong Kong subsidiary is not a "beneficial owner," YS Group may not be able to enjoy a preferential withholding tax rate of 5.0% and dividend payable by its PRC subsidiaries to its Hong Kong subsidiary will be subject to withholding tax at the rate of 10.0%.

The EIT Law and its implementation rules also provide that if an enterprise incorporated outside China has its "de facto management bodies" within China, such enterprise may be deemed a "PRC resident enterprise" for tax purposes and be subject to an enterprise income tax rate of 25.0% on its global incomes. "De facto management body" is defined as the body that has the significant and overall management and control over the business, personnel, accounts and properties of an enterprise. In April 2009, SAT promulgated a circular, known as Circular 82, and partially amended by Circular 9 promulgated in January 2014, to clarify the certain criteria for the determination of the "de facto management bodies" for foreign enterprises controlled by PRC enterprises or PRC enterprise groups. Further to Circular 82, the SAT issued a bulletin, known as Bulletin 45, effective in September 2011 and lately amended on June 15, 2018, respectively to provide more guidance on the implementation of Circular 82 and clarify the reporting and filing obligations of such "Chinese-controlled offshore incorporated resident enterprises." Although Circular 82 and Bulletin 45 explicitly provide that the above standards apply to enterprises that are registered outside China and controlled by PRC enterprises or PRC enterprise groups, these regulations may reflect SAT's criteria for determining the tax residence of foreign enterprises in general.

However, there have been no official implementation rules regarding the determination of the "de facto management bodies" for foreign enterprises not controlled by PRC enterprises (including companies like ourselves). Therefore, it remains unclear how the tax authorities will treat a case such as YS Biopharma and its subsidiaries following the consummation of the Business Combination. However, if the PRC authorities were to subsequently determine, or any future regulation provides, that it should be treated as a PRC resident enterprise, it will be subject to the uniform 25.0% enterprise income tax on its global incomes. In addition, although the EIT Law provides that dividend payments between qualified PRC-resident enterprises are exempt from enterprise income tax, there is uncertainty to the detailed qualification requirements for this exemption and whether dividend payments by PRC subsidiaries of YS Biopharma to YS Biopharma will meet such qualification requirements even if it is considered a PRC resident enterprise for tax purposes.

There remains significant uncertainty as to the interpretation and application of applicable PRC tax laws and rules by the PRC tax authorities, and the PRC tax laws, rules and regulations may also change. If there is any change to applicable tax laws and rules and interpretation or application with respect to such laws and rules, the value of your investment in YS Group's shares may be materially affected.



***YS Group and YS Biopharma's Shareholders face uncertainties with respect to the Business Combination and other indirect transfers of equity interests in PRC resident enterprises.***

Under the SAT Bulletin 7, an “indirect transfer” of assets, including equity interests in a PRC resident enterprise, by non-PRC resident enterprises may be re-characterized and treated as a direct transfer of PRC taxable assets, if such arrangement does not have a reasonable commercial purpose and was established for the purpose of reducing, deferring or avoiding payment of PRC enterprise income tax. As a result, gains derived from such indirect transfer may be subject to PRC enterprise income tax. According to SAT Bulletin 7, “PRC taxable assets” include assets attributed to an establishment in China, immovable properties in China, and equity investments in PRC resident enterprises. In respect of an indirect offshore transfer of assets of a PRC establishment, the relevant gain is to be regarded as effectively connected with the PRC establishment and therefore included in its enterprise income tax filing, and would consequently be subject to PRC enterprise income tax at a rate of 25.0%. Where the underlying transfer relates to the immovable properties in China or to equity investments in a PRC resident enterprise, which is not effectively connected to a PRC establishment of a non-resident enterprise or otherwise provided in the SAT Bulletin 7, a PRC enterprise income tax at 10.0% would apply, subject to available preferential tax treatment under applicable tax treaties or similar arrangements, and the party who is obligated to make the transfer payments has the withholding obligation. There is uncertainty as to the implementation details of SSAT Bulletin 7. If SAT Bulletin 7 was determined by the tax authorities to be applicable to some of YS Group’s transactions involving PRC taxable assets, including the Business Combination, the offshore subsidiaries of YS Group and YS Biopharma conducting the relevant transactions might be required to spend valuable resources to comply with SAT Bulletin 7 or to establish that the relevant transactions should not be taxed under SAT Bulletin 7.

On October 17, 2017, the SAT issued the Bulletin on Issues Concerning the Source-based Withholding of Enterprise Income Tax on Non-resident Enterprises, or Bulletin 37, which became effective on December 1, 2017. According to Bulletin 37, if the withholding agent fails to or is unable to withhold the income tax in accordance with the law, the tax authority may order the payment within a time limit, and non-resident enterprises shall declare and make the payment within such time limit required by the tax authority, and the non-resident enterprise will be deemed to have cleared its tax payment on time if it voluntarily declares and pays the tax before or within the time limit the tax authority orders it to do so. If the taxable income before withholding on a source-basis falls within the form of dividends or any equity investment gains, the date of triggering obligations to settle such tax payments is the date of actual payment of the dividends or other equity investment gains. In addition, on December 1, 2017, Bulletin 37 repealed the Notice of the SAT on Strengthening the Administration over Enterprise Income Tax on Income of Non-resident Enterprises from Equity Transfer and Notice of the SAT on Issuing the Interim Measures for the Administration of Source-based Withholding of the Enterprise Income Tax of Non-resident Enterprises issued by the SAT on December 10, 2009 and January 1, 2009, respectively.

As a result, SAT Bulletin 7 could apply if the Business Combination did not have a reasonable business purpose and was being carried out in order to evade PRC corporate income tax obligations. Although we believe that SAT Bulletin 7 does not apply to the Business Combination, it is possible that PRC tax authorities would make an assessment that the Business Combination is subject to SAT Bulletin 7. If SAT Bulletin 7 were to apply to the Business Combination, there would be PRC 10% withholding tax imposed on any gain deemed, from a PRC tax perspective, to have been realized from the Business Combination. Also, YS Group, YS Biopharma and their respective non-PRC Shareholders may have the risk of being taxed for the disposition of YS Group’s Shares and may be required to spend valuable resources to comply with SAT Bulletin 7 and SAT Bulletin 37 or to establish that YS Group, YS Biopharma and their respective non-PRC Shareholders should not be taxed as an indirect transfer, which may have a material adverse effect on their results of operations and financial condition or the investment by non-PRC investors in YS Biopharma’s securities.

In addition, following the consummation of Business Combination, since YS Biopharma may pursue acquisitions, and may conduct acquisitions involving complex corporate structures, the PRC tax authorities may, at their discretion, adjust the capital gains or request that it submit additional documentation for their review in connection with any potential acquisitions, which may cause it to incur additional acquisition costs or delay YS Group’s acquisition timetable.

***Dividends payable to YS Biopharma's foreign investors and gains on the sale of YS Biopharma's securities by foreign investors may become subject to PRC tax.***

Under the EIT Law and its implementation regulations issued by the State Council, a 10% PRC withholding tax is applicable to dividends payable to investors that are non-resident enterprises, which do not have an establishment or place of business in China or which have such establishment or place of business but the dividends are not effectively connected with such establishment or place of business, to the extent such dividends are derived from sources within China. Similarly, any gain realized on the transfer of the ADSs by such investors is also subject to PRC tax at a current rate of 10%, subject to any reduction or exemption set forth in applicable tax treaties or under applicable tax arrangements between jurisdictions, if such gain is regarded as income derived from sources within China. If YS Biopharma is deemed a PRC resident enterprise following the consummation of the Business Combination, dividends paid on YS Biopharma's securities, and any gain realized from the transfer of YS Biopharma's securities, would be treated as income derived from sources within China and would as a result be subject to PRC taxation. Furthermore, if YS Biopharma is deemed a PRC resident enterprise, dividends payable to individual investors who are non-PRC residents and any gain realized on the transfer of YS Biopharma's securities by such investors may be subject to PRC tax at a current rate of 20%, subject to any reduction or exemption set forth in applicable tax treaties or under applicable tax arrangements between jurisdictions. If YS Biopharma or any of its subsidiaries established outside China are considered a PRC resident enterprise, it is unclear whether holders of the ADSs would be able to claim the benefit of income tax treaties or agreements entered into between China and other countries or areas. If dividends payable to its non-PRC investors, or gains from the transfer of YS Biopharma's securities by such investors, are deemed as income derived from sources within China and thus are subject to PRC tax, the value of your investment in YS Biopharma's securities may decline significantly.

***YS Biopharma faces regulatory uncertainties in China that could restrict its ability to grant share incentive awards to its employees or consultants who are PRC citizens.***

Pursuant to the Notices on Issues concerning the Foreign Exchange Administration for Domestic Individuals Participating in a Stock Incentive Plan of an Overseas Publicly-Listed Company issued by SAFE on February 15, 2012, or Circular 7, a qualified PRC agent (which could be the PRC subsidiary of the overseas-listed company) is required to file, on behalf of "domestic individuals" (both PRC residents and non-PRC residents who reside in China for a continuous period of not less than one year, excluding the foreign diplomatic personnel and representatives of international organizations) who are granted shares or share options by the overseas-listed company according to its share incentive plan, an application with SAFE to conduct SAFE registration with respect to such share incentive plan, and obtain approval for an annual allowance with respect to the purchase of foreign exchange in connection with the share purchase or share option exercise. Such PRC individuals' foreign exchange income received from the sale of shares and dividends distributed by the overseas listed company and any other income shall be fully remitted into a collective foreign currency account in China, which is opened and managed by the PRC domestic agent before distribution to such individuals. In addition, such domestic individuals must also retain an overseas entrusted institution to handle matters in connection with their exercise of share options and their purchase and sale of shares. The PRC domestic agent also needs to update registration with SAFE within three months after, among others, the overseas-listed company materially changes its share incentive plan, including making any new share incentive plans.

Upon consummation of the Business Combination, YS Biopharma will adopt a share incentive plan and assume the outstanding share incentive awards granted by YS Group and may grant options in the future. As such, YS Biopharma, from time to time, needs to apply for or update YS Group's registration with SAFE or its local branches on behalf of its PRC domestic employees or consultants who receive options or other equity-based incentive grants under its share incentive plan or material changes in its share incentive plan. However, it may not always be able to make applications or update its registration on behalf of its PRC domestic employees or consultants who hold any type of share incentive awards in compliance with Circular 7, nor can it ensure you that such applications or update of registration will be successful. If YS Biopharma or the participants of its share incentive plan who are PRC domestic individuals fail to comply with Circular 7, YS Biopharma and/or such participants of its share incentive plan may be subject to fines and legal sanctions, there may be additional restrictions on the ability of such participants to exercise their share options or remit

proceeds gained from sale of their shares into China, and YS Biopharma may be prevented from further granting share incentive awards under its share incentive plan to its employees or consultants who are PRC domestic individuals.

***It may be difficult for overseas regulators to conduct investigation or collect evidence within China.***

Shareholder claims or regulatory investigation that are common in the United States generally are difficult to pursue as a matter of law or practicality in China. For example, in China, there are significant legal and other obstacles to providing information needed for regulatory investigations or litigations initiated outside China. Although the authorities in China may establish a regulatory cooperation mechanism with the securities regulatory authorities of another country or region to implement cross-border supervision and administration, such cooperation with the securities regulatory authorities in the United States may not be efficient in the absence of mutual and practical cooperation mechanism. Furthermore, according to Article 177 of the PRC Securities Law, which became effective in March 2020, no overseas securities regulator is allowed to directly conduct investigation or evidence collection activities within the PRC territory. While detailed interpretation of or implementation rules under Article 177 have yet to be promulgated, the inability for an overseas securities regulator to directly conduct investigation or evidence collection activities within China may further increase the difficulties you face in protecting your interests. See also the section entitled “— Your ability to effect service of legal process, enforce judgments or bring actions against YS Biopharma, YS Biopharma, Summit or certain of their officers and directors outside the U.S. will be limited and additional costs may be required.”

***If the custodians or authorized users of YS Group’s controlling non-tangible assets, including chops and seals, fail to fulfill their responsibilities, or misappropriate or misuse these assets, its business and operations may be materially and adversely affected.***

Under PRC law, legal documents for corporate transactions, including agreements and contracts such as the leases and sales contracts that YS Group’s business relies on, are executed using the chop or seal of the signing entity or with the signature of a legal representative whose designation is registered and filed with the relevant local branch of the market supervision administration.

In order to maintain the physical security of its chops and the chops of its PRC entities, YS Group generally stores these items in secured locations accessible only by the authorized personnel of each of its PRC subsidiaries. Although YS Group monitors such authorized personnel, there is no assurance such procedures will prevent all instances of abuse or negligence. Accordingly, if any of YS Group’s authorized personnel misuse or misappropriate its corporate chops or seals, YS Group could encounter difficulties in maintaining control over the relevant entities and experience significant disruption to its operations. If a designated legal representative obtains control of the chops in an effort to obtain control over any of its PRC subsidiaries, YS Group would need to pass a new shareholder or board resolution to designate a new legal representative and it would need to take legal action to seek the return of the chops, apply for new chops with the relevant authorities, or otherwise seek legal redress for the violation of the representative’s fiduciary duties to it, which could involve significant time and resources and divert management attention away from its regular business. In addition, the affected entity may not be able to recover corporate assets that are sold or transferred out of YS Group’s control in the event of such a misappropriation if a transferee relies on the apparent authority of the representative and acts in good faith.

***YS Biopharma’s Hong Kong subsidiary or any future operations in Hong Kong or Macau could become subject to more influence and/or control of the PRC government if the Hong Kong or Macau legal system becomes more integrated into the PRC legal system.***

Most national laws and regulations of the PRC are not directly applicable in Hong Kong or Macau, except for those listed in the Basic Law of the Hong Kong Special Administrative Region of the PRC or the Basic Law of the Macau Special Administrative Region of the PRC (the “Basic Laws”). However, such list of national laws and regulations that are applicable in Hong Kong or Macau can be expanded by amendment to the Basic Laws. There is no assurance that the Basic Laws will not be further amended to apply more PRC laws and regulations in Hong Kong, or that the PRC and/or Hong Kong or Macau government will not take other actions to promote the further integration of Hong Kong or Macau legal system into the PRC legal system. Although YS Group does not have substantive business operations in Hong Kong and Macau and do not

currently expect to have any substantive operations in these regions in the foreseeable future, YS Group cannot assure you that YS Biopharma's Hong Kong subsidiary or any future operations in Hong Kong or Macau will not be subject to more influence and/or control of the PRC government or even direct oversight or intervention from them if the Hong Kong or Macau legal system becomes more integrated into the PRC legal system, or if the regulators in Hong Kong or Macau adopt similar rules or policies through affirmative legislation or rulemaking within the scope of the authority conferred by the Basic Laws. As a result, YS Group cannot assure you that YS Biopharma's Hong Kong subsidiary or any future operations in Hong Kong or Macau will not be exposed to the similar regulatory and/or policy risks and uncertainties faced by YS Biopharma's subsidiaries in China in the future.

#### **Risks Related to Ownership of the YS Biopharma Ordinary Shares**

*The price of the YS Biopharma Ordinary Shares may be volatile, and the value of the YS Biopharma Ordinary Shares may decline.*

YS Biopharma cannot predict the prices at which the YS Biopharma Ordinary Shares will trade. The price of the YS Biopharma Ordinary Shares may not bear any relationship to the market price at which the YS Biopharma Ordinary Shares will trade after the Business Combination or to any other established criteria of the value of YS Biopharma's business and prospects, and the market price of the YS Biopharma Ordinary Shares following the Business Combination may fluctuate substantially. In addition, the trading price of the YS Biopharma Ordinary Shares following the Business Combination is likely to be volatile and could be subject to fluctuations in response to various factors, some of which are beyond YS Biopharma's control. These fluctuations could cause you to lose all or part of your investment in the YS Biopharma Ordinary Shares as you might be unable to sell your shares at or above the price you paid in the Business Combination. Factors that could cause fluctuations in the trading price of the YS Biopharma Ordinary Shares include the following:

- actual or anticipated fluctuations in YS Biopharma's financial condition or results of operations;
- variance in YS Biopharma's financial performance from expectations of securities analysts;
- changes in the pricing of YS Biopharma's products;
- changes in YS Biopharma's projected operating and financial results;
- changes in laws or regulations applicable to YS Biopharma's products;
- announcements by YS Biopharma or its competitors of significant business developments, acquisitions, strategic partnerships or new offerings;
- sales of the YS Biopharma Ordinary Shares by YS Biopharma or its shareholders;
- significant product recalls, regulatory investigations, disruptions to or other incidents involving YS Biopharma's products;
- YS Biopharma's involvement in litigation;
- conditions or developments affecting the vaccine industries;
- future sales of the YS Biopharma Ordinary Shares by YS Biopharma or its shareholders, as well as the anticipation of lock-up releases;
- changes in senior management or key personnel;
- the trading volume of the YS Biopharma Ordinary Shares;
- changes in the anticipated future size and growth rate of YS Biopharma's markets;
- publication of research reports or news stories about YS Biopharma, its competitors or its industry, or positive or negative recommendations or withdrawal of research coverage by securities analysts;
- general economic and market conditions; and
- other events or factors, including those resulting from war including the conflict between Russia and Ukraine, incidents of terrorism, global pandemics or responses to these events.

Broad market and industry fluctuations, as well as general economic, political, regulatory and market conditions, may also negatively impact the market price of the YS Biopharma Ordinary Shares. In addition, biopharmaceutical stocks have historically experienced high levels of volatility. In the past, companies who have experienced volatility in the market price of their securities have been subject to securities class action litigation. YS Biopharma may be the target of this type of litigation in the future, which could result in substantial expenses and divert YS Biopharma's management's attention.

***A market for YS Biopharma's securities may not develop or be sustained, which would adversely affect the liquidity and price of its securities.***

Following the Business Combination, the price of YS Biopharma's securities may fluctuate significantly due to the market's reaction to the Business Combination and general market and economic conditions. An active trading market for YS Biopharma's securities following the Business Combination may never develop or, if developed, it may not be sustained. In addition, the price of YS Biopharma's securities after the Business Combination can vary due to general economic conditions and forecasts, its general business condition and the release of its financial reports. Additionally, if YS Biopharma's securities become delisted from the Nasdaq Stock Market LLC and are quoted on the OTC Bulletin Board (an inter-dealer automated quotation system for equity securities that is not a national securities exchange) or the combined company's securities are not listed on the Nasdaq Stock Market LLC and are quoted on the OTC Bulletin Board, the liquidity and price of YS Biopharma's securities may be more limited than if YS Biopharma were quoted or listed on Nasdaq, NYSE or another national securities exchange. You may be unable to sell your securities unless a market can be established or sustained.

***Provisions in the Amended YS Biopharma Articles could discourage, delay or prevent a change of control of YS Biopharma and may affect the trading price of the YS Biopharma Ordinary Shares.***

Some provisions of the Amended YS Biopharma Articles may discourage, delay or prevent a change in control of YS Biopharma or management that shareholders may consider favorable. These provisions, which are summarized below, are expected to discourage coercive takeover practices and inadequate takeover bids. These provisions are also designed to encourage persons seeking to acquire control of YS Biopharma to first negotiate with the YS Biopharma Board. However, these provisions could also have the effect of discouraging others from attempting hostile takeovers and, as a consequence, they may also inhibit temporary fluctuations in the market price of the YS Biopharma Ordinary Shares and/or YS Biopharma Preference Shares that often result from actual or rumored hostile takeover attempts. These provisions may also have the effect of preventing changes in the management of YS Biopharma. It is possible that these provisions could make it more difficult to accomplish transactions that shareholders may otherwise deem to be in their best interests.

- The Amended YS Biopharma Articles only permit YS Biopharma's shareholders together holding at least 25% of YS Biopharma's paid-up voting share capital to requisition a general meeting.
- The Amended YS Biopharma Articles require the affirmative vote of the holders of at least 66<sup>2</sup>/<sub>3</sub>% in voting power of all the then outstanding ordinary shares as being entitled to do so to pass any special resolution, which special resolution is required to, among others, amend the memorandum and articles of association or approve a merger.
- Under the Amended YS Biopharma Articles, the YS Biopharma Board may comprise up to seven directors (or such greater number as may be approved by special resolution upon an amendment and/or restatement of the Amended YS Biopharma Articles). The directors shall be appointed and removed by special resolution of the shareholders.

In addition, these provisions may make it difficult and expensive for a third party to pursue a tender offer, change in control or takeover attempt that is opposed by YS Biopharma's management or the YS Biopharma Board. Shareholders who might desire to participate in these types of transactions may not have an opportunity to do so, even if the transaction is favorable to shareholders. These anti-takeover provisions could substantially impede the ability of shareholders to benefit from a change in control or change YS Biopharma's management and the YS Biopharma Board and, as a result, may adversely affect the market price of the YS Biopharma Ordinary Shares and/or YS Biopharma Preference Shares and your ability to realize any potential change of control premium. See "*Comparison of Corporate Governance and Shareholder Rights — Anti-Takeover Provisions.*"

***The warrant agreement relating to the YS Biopharma Warrants provides that YS Biopharma agrees that any action, proceeding or claim against YS Biopharma arising out of or relating in any way to such agreement will be brought and enforced in the courts of the State of New York or the United States District Court for the Southern District of New York, and that it irrevocably submits to such jurisdiction, which will be the exclusive forum for any such action, proceeding or claim. This exclusive forum provision could limit the ability of holders of the YS Biopharma Warrants to obtain what they believe to be a favorable judicial forum for disputes related to such agreement.***

In connection with the Business Combination, YS Biopharma entered into a Warrant Assignment Agreement pursuant to which Summit will assign to YS Biopharma all of its rights, title, interests, and liabilities and obligations in and under the Warrant Agreement, dated June 8, 2021, by and between Summit and Continental Stock Transfer & Trust Company. The Assignment Agreement will provide that any action, proceeding or claim against YS Biopharma arising out of or relating in any way to such agreement, except for claims for which the federal courts have exclusive jurisdiction, such as suits brought to enforce any duty or liability created by the Exchange Act or the rules and regulations thereunder, will be brought and enforced in the courts of the State of New York or the United States District Court for the Southern District of New York, which will be the exclusive forum for any such action, proceeding or claim.

The exclusive forum provision in the Warrant Assignment Agreement may limit the ability of holders of the YS Biopharma Warrants to bring a claim in a judicial forum that it finds favorable for disputes related to the Warrant Assignment Agreement, which may discourage such lawsuits against YS Biopharma and its directors or officers. Alternatively, if a court were to find this exclusive forum provision inapplicable to, or unenforceable in respect of, one or more of the specified types of actions or proceedings, YS Biopharma may incur additional costs associated with resolving such matters in other jurisdictions, which could adversely affect its business, financial condition and results of operations and result in a diversion of the time and resources of its management and board of directors.

***If YS Biopharma does not meet the expectations of equity research analysts, if they do not publish research or reports about YS Biopharma's business or if they issue unfavorable commentary or downgrade the YS Biopharma Ordinary Shares, the price of the YS Biopharma Ordinary Shares could decline.***

The trading market for the YS Biopharma Ordinary Shares will rely in part on the research and reports that equity research analysts publish about YS Biopharma and its business. The analysts' estimates are based upon their own opinions and are often different from YS Biopharma's estimates or expectations. If YS Biopharma's results of operations are below the estimates or expectations of public market analysts and investors, the price of the YS Biopharma Ordinary Shares could decline. Moreover, the price of the YS Biopharma Ordinary Shares could decline if one or more securities analysts downgrade the YS Biopharma Ordinary Shares or if those analysts issue other unfavorable commentary or cease publishing reports about YS Biopharma or its business.

***YS Biopharma's issuance of additional share capital in connection with financings, acquisitions, investments, YS Biopharma's equity incentive plans or otherwise will dilute all other shareholders.***

YS Biopharma expects to issue additional share capital in the future that will result in dilution to all other shareholders. YS Biopharma expects to grant equity awards to employees and directors under its equity incentive plans. YS Biopharma may also raise capital through equity financings in the future. As part of YS Biopharma's business strategy, YS Biopharma may acquire, make investments in or engage in strategic partnerships with companies, solutions or technologies and issue equity securities to pay for any such acquisition, investment or partnership. Any such issuances of additional share capital may cause shareholders to experience significant dilution of their ownership interests and the per share value of the YS Biopharma Ordinary Shares to decline.

***YS Biopharma does not intend to pay dividends for the foreseeable future and, as a result, your ability to achieve a return on your investment will depend on appreciation in the price of the YS Biopharma Ordinary Shares.***

YS Biopharma does not intend to pay any cash dividends in the foreseeable future, and any determination to pay dividends in the future will be at the discretion of the Board. Accordingly, you may need to rely on sales of

the YS Biopharma Ordinary Shares after price appreciation, which may never occur, as the only way to realize any future gains on your investment.

***YS Biopharma will be an emerging growth company and may take advantage of certain reduced reporting requirements.***

YS Biopharma will be an “emerging growth company,” as defined in the JOBS Act, and YS Biopharma may take advantage of certain exemptions from various requirements applicable to other public companies that are not emerging growth companies including, most significantly, not being required to comply with the auditor attestation requirements of Section 404 of Sarbanes-Oxley Act of 2002 for so long as YS Biopharma is an emerging growth company. As a result, if YS Biopharma elects not to comply with such auditor attestation requirements, YS Biopharma’s investors may not have access to certain information they may deem important.

***YS Biopharma will be a foreign private issuer within the meaning of the rules under the Exchange Act, and as such YS Biopharma will be exempt from certain provisions applicable to U.S. domestic public companies.***

Because YS Biopharma will qualify as a foreign private issuer under the Exchange Act, YS Biopharma will be exempt from certain provisions of the securities rules and regulations in the United States that are applicable to U.S. domestic issuers, including:

- the rules under the Exchange Act requiring the filing with the SEC of quarterly reports on Form 10-Q or current re-ports on Form 8-K;
- the sections of the Exchange Act regulating the solicitation of proxies, consents, or authorizations in respect of a security registered under the Exchange Act;
- the sections of the Exchange Act requiring insiders to file public reports of their stock ownership and trading activities and liability for insiders who profit from trades made in a short period of time; and
- the selective disclosure rules by issuers of material nonpublic information under Regulation FD.

YS Biopharma will be required to file an annual report on Form 20-F within four months of the end of each fiscal year. In addition, YS Biopharma intends to publish its results on a quarterly basis as press releases, distributed pursuant to the rules and regulations of Nasdaq. However, the information YS Biopharma will be required to file with or furnish to the SEC will be less extensive and less timely compared to that required to be filed with the SEC by U.S. domestic issuers. As a result, you may not be afforded the same protections or information that would be made available to you were you investing in a U.S. domestic issuer.

***YS Biopharma may lose its foreign private issuer status in the future, which could result in significant additional costs and expenses.***

As discussed above, YS Biopharma will be a foreign private issuer, and therefore, YS Biopharma will not be required to comply with all of the periodic disclosure and current reporting requirements of the Exchange Act. The determination of foreign private issuer status is made annually on the last business day of an issuer’s most recently completed second fiscal quarter. In the future, YS Biopharma would lose its foreign private issuer status if (1) more than 50% of YS Biopharma’s outstanding voting securities are owned by U.S. residents and (2) a majority of YS Biopharma’s directors or executive officers are U.S. citizens or residents, or YS Biopharma fails to meet additional requirements necessary to avoid loss of foreign private issuer status. If YS Biopharma loses its foreign private issuer status, YS Biopharma will be required to file with the SEC periodic reports and registration statements on U.S. domestic issuer forms, which are more detailed and extensive than the forms available to a foreign private issuer. YS Biopharma will also have to mandatorily comply with U.S. federal proxy requirements, and YS Biopharma’s officers, directors and principal shareholders will become subject to the short-swing profit disclosure and recovery provisions of Section 16 of the Exchange Act. In addition, YS Biopharma will lose its ability to rely upon exemptions from certain corporate governance requirements under the listing rules of Nasdaq. As a U.S. listed public company that is not a foreign private issuer, YS Biopharma will incur significant additional legal, accounting and other expenses that YS Biopharma will not incur as a foreign private issuer.

***As an exempted company incorporated in the Cayman Islands, YS Biopharma is permitted to adopt certain home country practices in relation to corporate governance matters that differ significantly from Nasdaq's corporate governance requirements; these practices may afford less protection to shareholders. If YS Biopharma opts to rely on such exemptions in the future, such decision might afford less protection to holders of YS Biopharma's ordinary shares.***

As a Cayman Islands exempted company that will be listed on the Nasdaq Stock Market LLC, YS Biopharma will be subject to the Nasdaq listing standards. Section 5605(b)(1), Section 5605(c)(2) and Section 5635(c) of the Nasdaq Listing Rules require listed companies to have, among other things, a majority of its board members to be independent, an audit committee of at least three members and shareholders' approval on adoption of equity incentive awards plans. However, the Nasdaq rules permit a foreign private issuer like YS Biopharma to follow the corporate governance practices of its home country. The corporate governance practice in YS Biopharma's home country, the Cayman Islands, does not require a majority of YS Biopharma's board of directors to consist of independent directors or the implementation of a nominating and corporate governance committee. Since a majority of YS Biopharma's board of directors would not consist of independent directors if YS Biopharma relied on the foreign private issuer exemption, fewer board members would be exercising independent judgment and the level of board oversight on the management of YS Biopharma might decrease as a result. In addition, YS Biopharma could opt to follow Cayman Islands law instead of the Nasdaq requirements that mandate that YS Biopharma obtain shareholder approval for certain dilutive events, such as an issuance that will result in a change of control, certain transactions other than a public offering involving issuances of 20% or greater interests in the company and certain acquisitions of the shares or assets of another company. While YS Biopharma does not currently intend to follow home country practice in lieu of the above requirements, YS Biopharma could decide in the future to follow home country practice and its board of directors could make such a decision to depart from such requirements by ordinary resolution.

***The post-combination company may be a "controlled company" within the meaning of the Nasdaq Stock Market listing rules and, as a result, may rely on exemptions from certain corporate governance requirements that provide protection to shareholders of other companies.***

YS Biopharma may be a "controlled company" as defined under the Nasdaq Stock Market listing rules after the completion of the Business Combination because it is expected that Mr. Yi Zhang will beneficially control more than 50% of the total voting power of all issued and outstanding YS Biopharma Ordinary Shares through the acting-in-concert arrangement under the Concert Party Agreement immediately following the consummation of the Business Combination, if 75% or more of the Summit Public Shareholders will redeem their Summit Public Shares. As a result, Mr. Yi Zhang will have the ability to control or significantly influence the outcome of matters requiring approval by shareholders. For the details of the Concert Party Agreement, please refer to the sections entitled "Certain Relationships and Related Person Transactions — YS Group and YS Biopharma Relationships and Related Party Transactions — Concert Party Agreement" and "Summary of the Proxy Statement/Prospectus — The Parties to the Business Combination". In addition, for so long as YS Biopharma, after the completion of the Business Combination, remain a controlled company under that definition, it is permitted to elect to rely on, and may rely on, certain exemptions from corporate governance rules, including an exemption from the rule that a majority of its board of directors must be independent directors. YS Biopharma does not currently plan to utilize the exemptions available for controlled companies after the completion of this Business Combination, but instead, it plans to rely on the exemption available for foreign private issuers to follow its home country governance practices. See the section entitled "— Risks Related to Ownership of the YS Biopharma Ordinary Shares—As an exempted company incorporated in the Cayman Islands, YS Biopharma is permitted to adopt certain home country practices in relation to corporate governance matters that differ significantly from Nasdaq's corporate governance requirements; these practices may afford less protection to shareholders. If YS Biopharma opts to rely on such exemptions in the future, such decision might afford less protection to holders of YS Biopharma's ordinary shares." If it ceases to be a foreign private issuer or if it cannot rely on the home country governance practice exemptions for any reason, it may decide to invoke the exemptions available for a controlled company as long as its remain a controlled company. As a result, you will not have the same protection afforded to shareholders of companies that are subject to these corporate governance requirements.



***If YS Group fails to remediate its material weakness and implement and maintain an effective system of internal control over financial reporting, YS Group may be unable to accurately report its results of operations, meet its reporting obligations or prevent fraud.***

YS Biopharma is a private company with limited accounting personnel and other resources to address its internal control over financial reporting. As a company with less than \$1.235 billion in revenue for its last fiscal year, YS Group qualifies as an “emerging growth company” pursuant to the JOBS Act. An emerging growth company may take advantage of specified reduced reporting and other requirements that are otherwise applicable generally to public companies. These provisions include exemption from the auditor attestation requirement under Section 404 of the Sarbanes-Oxley Act of 2002 in the assessment of the emerging growth company’s internal control over financial reporting. YS Group’s management has not completed an assessment of the effectiveness of its internal control and procedures over financial reporting and its independent registered public accounting firm has not conducted an audit of its internal control over financial reporting. In connection with the audit of its consolidated financial statements as of and for the years ended March 31, 2022 and 2021, YS Group and its independent registered public accounting firm identified a material weakness in its internal control over financial reporting as of March 31, 2022. As defined in the standards established by the PCAOB, a “material weakness” is a deficiency, or a combination of deficiencies, in internal control over financial reporting, such that there is a reasonable possibility that a material misstatement of its annual or interim consolidated financial statements will not be prevented or detected on a timely basis.

The material weakness identified relates to lack of sufficient competent financial reporting and accounting personnel with appropriate understanding of U.S. GAAP to design and implement formal period-end financial reporting policies and procedures to address complex U.S. GAAP technical accounting issues, and to prepare and review YS Group’s consolidated financial statements and related disclosures in accordance with U.S. GAAP and financial reporting requirements set forth by the SEC. Neither YS Group nor its independent registered public accounting firm had undertaken a comprehensive assessment of its internal control under the Sarbanes-Oxley Act for purposes of identifying and reporting material weaknesses and other control deficiencies in its internal control over financial reporting. Had YS Group performed a formal assessment of its internal control over financial reporting or had its independent registered public accounting firm performed an audit of its internal control over financial reporting, additional deficiencies may have been identified.

To remediate YS Group’s material identified material weakness, YS Group has adopted measures to improve its internal control over financial reporting, including, among others: (i) hiring additional qualified accounting and financial personnel with appropriate knowledge and experience in U.S. GAAP accounting and SEC reporting, and (ii) organizing regular training for its accounting staffs, especially training related to U.S. GAAP and SEC reporting requirements. YS Group also plan to adopt additional measures to improve YS Group’s internal control over financial reporting, including among others creating U.S. GAAP accounting policies and procedures manual, which will be maintained, reviewed and updated, on a regular basis, to the latest U.S. GAAP accounting standards, and further hiring executive accounting personnel with strong knowledge and experience in U.S. GAAP accounting and SEC reporting.

The implementation of these measures, however, may not fully address the material weakness identified in YS Group’s internal control over financial reporting, and YS Group cannot conclude that it has been fully remedied. YS Group’s failure to correct the material weakness or its failure to discover and address any other material weaknesses or deficiencies could result in inaccuracies in its financial statements and impair its ability to comply with applicable financial reporting requirements and related regulatory filings on a timely basis. Moreover, ineffective internal control over financial reporting could significantly hinder its ability to prevent fraud.

***As a result of being a public company, YS Biopharma will be obligated to develop and maintain proper and effective internal controls over financial reporting, and any failure to maintain the adequacy of these internal controls may adversely affect investor confidence in YS Biopharma and, as a result, the value of the YS Biopharma Ordinary Shares.***

YS Biopharma will be required, pursuant to Section 404 of the Sarbanes-Oxley Act, to furnish a report by management on, among other things, the effectiveness of its internal control over financial reporting as of the end of the fiscal year that coincides with the filing of YS Biopharma’s second annual report on Form 20-F. This assessment will need to include disclosure of any material weaknesses identified by YS Biopharma’s

management in its internal control over financial reporting. In addition, YS Biopharma's independent registered public accounting firm will be required to attest to the effectiveness of its internal control over financial reporting in YS Biopharma's first annual report required to be filed with the SEC following the date YS Biopharma is no longer an "emerging growth company."

YS Biopharma's current controls and any new controls that it develops may become inadequate because of changes in conditions in YS Biopharma's business. In addition, changes in accounting principles or interpretations could also challenge YS Biopharma's internal controls and require that YS Biopharma establishes new business processes, systems and controls to accommodate such changes. Additionally, if these new systems, controls or standards and the associated process changes do not give rise to the benefits that YS Biopharma expects or do not operate as intended, it could materially and adversely affect YS Biopharma's financial reporting systems and processes, YS Biopharma's ability to produce timely and accurate financial reports or the effectiveness of internal control over financial reporting. Moreover, YS Biopharma's business may be harmed if YS Biopharma experiences problems with any new systems and controls that result in delays in their implementation or increased costs to correct any post-implementation issues that may arise.

During the evaluation and testing process of YS Biopharma's internal controls, if YS Biopharma identifies one or more material weaknesses in its internal control over financial reporting, YS Biopharma will be unable to certify that its internal control over financial reporting is effective. YS Biopharma cannot assure you that there will not be material weaknesses or significant deficiencies in its internal control over financial reporting in the future. Any failure to maintain internal control over financial reporting could severely inhibit YS Biopharma's ability to accurately report its financial condition or results of operations. If YS Biopharma is unable to conclude that its internal control over financial reporting is effective, or if YS Biopharma's independent registered public accounting firm determines YS Biopharma has a material weakness or significant deficiency in its internal control over financial reporting, YS Biopharma could lose investor confidence in the accuracy and completeness of its financial reports, the market price of the YS Biopharma Ordinary Shares could decline, and YS Biopharma could be subject to sanctions or investigations by the SEC or other regulatory authorities. Failure to remedy any material weakness in YS Biopharma's internal control over financial reporting, or to implement or maintain other effective control systems required of public companies, could also restrict YS Biopharma's future access to the capital markets.

The growth and expansion of YS Biopharma's business places a continuous, significant strain on its operational and financial resources. Further growth of YS Biopharma's operations to support its customer base, its platform, solutions and its internal controls and procedures may not be adequate to support YS Biopharma's operations. As YS Biopharma continues to grow, YS Biopharma may not be able to successfully implement requisite improvements to these systems, controls and processes, such as system access and change. The growth and expansion of YS Biopharma's business places a continuous, significant strain on YS Biopharma's operational and financial resources. Further growth of YS Biopharma's operations to support its customer base, its information technology systems and its internal controls and procedures may not be adequate to support YS Biopharma's operations. As YS Biopharma continues to grow, it may not be able to successfully implement requisite improvements to these systems, controls and processes, such as system access and change management controls, in a timely or efficient manner. YS Biopharma's failure to improve its systems and processes, or their failure to operate in the intended manner, whether as a result of the growth of its business or otherwise, may result in its inability to accurately forecast its revenue and expenses, or to prevent certain losses. Moreover, the failure of YS Biopharma's systems and processes could undermine YS Biopharma's ability to provide accurate, timely and reliable reports on its financial and operating results and could impact the effectiveness of its internal control over financial reporting. In addition, YS Biopharma's systems and processes may not prevent or detect all errors, omissions or fraud.

***As a result of YS Biopharma's plans to expand operations, including to jurisdictions in which the tax laws may not be favorable, YS Biopharma's tax rate may fluctuate, its tax obligations may become significantly more complex and subject to greater risk of examination by taxing authorities or it may be subject to future changes in tax law, the impact of which could adversely affect YS Biopharma's after-tax profitability and financial results.***

Because YS Biopharma does not have a long history of operating at its present scale and has significant expansion plans, YS Biopharma's effective tax rate may fluctuate in the future. Future effective tax rates could be affected by YS Biopharma's operating results before taxes, changes in the composition of operating income

and earnings in countries or jurisdictions with differing tax rates, including as YS Biopharma expands into additional jurisdictions, changes in the amount of YS Biopharma's deferred tax assets and liabilities, changes in accounting and tax standards or practices, changes in tax laws, changes in the tax treatment of share-based compensation, and YS Biopharma's ability to structure its operations in an efficient and competitive manner.

Due to the complexity of multinational tax obligations and filings, YS Biopharma may have a heightened risk related to audits, examinations or administrative appeals by taxing authorities. Outcomes from current and future tax audits, examinations or administrative appeals could have an adverse effect on YS Biopharma's after-tax profitability and financial condition. Additionally, several tax authorities have increasingly focused attention on intercompany transfer pricing with respect to sales of products and services and the use of intangibles. Tax authorities could disagree with YS Biopharma's intercompany charges, cross-jurisdictional transfer pricing or other matters and assess additional taxes. If YS Biopharma does not prevail in any such disagreements, its profitability may be affected.

YS Biopharma's after-tax profitability and financial results may also be adversely impacted by changes in the relevant tax laws and tax rates, treaties, regulations, administrative practices and principles, judicial decisions and interpretations thereof, in each case, possibly with retroactive effect. For example, the Multilateral Convention to Implement Tax Treaty Related Measures to Prevent Base Erosion and Profit Shifting entered into force in 2018 among the jurisdictions that have ratified it. Additionally, many countries and organizations, such as the Organization for Economic Cooperation and Development, are also actively considering changes to existing tax laws or have proposed or enacted new laws that could increase YS Biopharma's tax obligations in countries in which it does business or cause YS Biopharma to change the way it operates its business. These recent changes and proposals could negatively impact YS Biopharma's taxation, especially as YS Biopharma expands its relationships and operations internationally.

***If YS Biopharma or any of its subsidiaries is treated as a "controlled foreign corporation" for U.S. federal income tax purposes, certain U.S. Holders may be subject to adverse U.S. federal income tax consequences.***

If a "United States person" (as defined in Section 7701(a)(30) of the Code) is treated as owning (directly, indirectly, or constructively) at least 10% of the total combined voting power of all classes of YS Biopharma's shares entitled to vote or at least 10% of the total value of shares of all classes of YS Biopharma's shares, such person may be treated as a "United States shareholder" with respect to each "controlled foreign corporation" ("CFC") within the meaning of Section 957(a) of the Code in the YS Group (if any), which may subject such person to adverse U.S. federal income tax consequences. Specifically, a United States shareholder of a CFC may be required to annually report and include in its U.S. taxable income its pro rata share of such CFC's "Subpart F income," "global intangible low-taxed income," and investments in U.S. property, whether or not YS Biopharma makes any distributions of profits or income of such CFC to such United States shareholder. If a U.S. Holder is treated as a United States shareholder of a CFC, failure to comply with applicable reporting obligations may subject such holder to significant monetary penalties and may extend the statute of limitations with respect to such holder's U.S. federal income tax return for the taxable year for which reporting was due. Additionally, an individual United States shareholder of a CFC generally would be denied certain tax deductions or foreign tax credits in respect of its income that may otherwise be allowable to a United States shareholder that is a U.S. corporation.

YS Biopharma cannot provide any assurances that it will assist U.S. Holders in determining whether YS Biopharma or any of its non-U.S. subsidiaries is treated as a CFC or whether any U.S. Holder is treated as a United States shareholder with respect to any such CFC, nor does YS Biopharma expect to furnish to any United States shareholders information that may be necessary to comply with the aforementioned reporting and tax paying obligations. U.S. Holders should consult their tax advisors regarding the potential application of the CFC rules to an investment in YS Biopharma Ordinary Shares.

***If YS Biopharma is or becomes a "passive foreign investment company" for U.S. federal income tax purposes, U.S. Holders may be subject to adverse U.S. federal income tax consequences.***

Based on the expected income, assets, and operations of YS Biopharma and its subsidiaries, YS Biopharma does not expect to be a PFIC in the taxable year that includes the Business Combination, although there can be no assurance in this regard. The determination of whether YS Biopharma is a PFIC is made on an annual basis and will depend on the composition of income and assets of YS Biopharma and its subsidiaries, and the

value of the assets of YS Biopharma and its subsidiaries, from time to time. Specifically, for any taxable year, a non-U.S. corporation will be classified as a PFIC for U.S. federal income tax purposes if either: (1) 75% or more of its gross income in such taxable year is passive income, or (2) 50% or more of the value of its assets (generally based on an average of the quarterly values of the assets) during such taxable year is attributable to assets that produce or are held for the production of passive income. The calculation of the value of the assets of YS Biopharma and its subsidiaries will be based, in part, on the quarterly market value of YS Biopharma Ordinary Shares, which is subject to change and may be volatile.

The determination of whether YS Biopharma is a PFIC also will depend, in part, on how, and how quickly, it uses its liquid assets and cash, including the cash acquired from Summit in the Business Combination. If YS Biopharma were to retain significant amounts of liquid assets, including cash, the risk of YS Biopharma being classified as a PFIC may substantially increase. Because there are uncertainties in the application of the relevant rules and PFIC status is a factual determination made annually after the close of each taxable year, there can be no assurance that YS Biopharma will not be a PFIC for the taxable year that includes the Business Combination or any future taxable year, and no opinion of counsel has or will be provided regarding the classification of YS Biopharma as a PFIC. If YS Biopharma were classified as a PFIC for any taxable year during which a U.S. Holder held YS Biopharma Ordinary Shares, YS Biopharma generally would continue to be treated as a PFIC for all succeeding taxable years during which such U.S. Holder held YS Biopharma Ordinary Shares.

If YS Biopharma were classified as a PFIC, such characterization could result in adverse U.S. federal income tax consequences to U.S. Holders, including increased tax liabilities under U.S. federal income tax laws and regulations and burdensome reporting requirements. YS Biopharma cannot assure any U.S. Holder that YS Biopharma will not be a PFIC for the taxable year that includes the Business Combination or any future taxable year. U.S. Holders should consult their tax advisors regarding the circumstances that may cause YS Biopharma to be classified as a PFIC and the consequences if YS Biopharma is classified as a PFIC.

#### **Risks Related to Summit and the Business Combination**

Unless otherwise stated or unless the context otherwise requires, the terms, “we,” “us,” “our,” “our company,” “Summit” refer to Summit Healthcare Acquisition Corp.

*The process of taking a company public by means of a business combination with a special purpose acquisition company is different from taking a company public through a traditional initial public offering and may create risks for our unaffiliated investors.*

A traditional initial public offering involves a company engaging underwriters to purchase its shares and resell them to the public. An underwritten offering imposes statutory liability on the underwriters for material misstatements or omissions contained in the registration statement unless they are able to sustain the burden of proving that they did not know and could not reasonably have discovered such material misstatements or omissions. This is referred to as a “due diligence” defense and results in the underwriters undertaking a detailed review of the business, financial condition and results of operations of the issuer and its subsidiaries. In a traditional initial public offering, investors may be able to recover damages from the underwriters in the event of misstatements and omission in the registration statement and unavailability of the due diligence defense. Going public via a business combination with a special purpose acquisition company (“SPAC”) does not involve any underwriters and may therefore result in less careful vetting of the operating company’s information that is presented to the public. In addition, going public via a business combination with a SPAC does not involve a book-building process as is the case in a traditional initial public offering. In a traditional initial public offering, the initial value of a company is set by investors who indicate the price at which they are prepared to purchase shares from the underwriters. In the case of a business combination with a SPAC, the value of the target company is established by means of negotiations between the target company, the SPAC and, in many cases, investors in a private investment in public equity (“PIPE”) deal who agree to purchase shares at the time of the business combination. The process of establishing the value of a target company in a business combination with a SPAC may be less effective than a traditional initial public offering book-building process and also does not reflect events that may have occurred between the date of the Business Combination Agreement and the Closing.

In addition, while traditional initial public offerings are frequently oversubscribed, resulting in additional potential demand for shares in the after-market following the initial public offering, there is no comparable process of generating investor demand in connection with a business combination between a target company and a SPAC, which may result in lower demand for YS Biopharma's securities after the Closing, which could in turn, decrease liquidity and trading prices as well as increase the trading volatility of YS Biopharma's securities after the Closing.

***Summit's current directors and officers and their affiliates have interests that are different from, or in addition to (and which may conflict with), the interests of its shareholders, and therefore potential conflicts of interest exist in recommending that shareholders vote in favor of approval of the Business Combination. Such conflicts of interests include that the Sponsor as well as Summit's directors and officers are expected to lose their entire investment in Summit if the Business Combination is not completed.***

When considering the Summit Board's recommendation to vote in favor of approving the Business Combination Proposal and the Merger Proposal, Summit shareholders should keep in mind that the Sponsor and Summit's directors and officers have interests in such proposals that are different from, or in addition to (and which may conflict with), those of Summit shareholders and warrant holders generally.

These interests include, among other things, the interests listed below:

- the fact that the Sponsor and Summit's directors and officers have agreed to waive their redemption rights with respect to their Summit Class B Ordinary Shares in connection with the completion of the proposed Business Combination;
- the fact that the Sponsor and certain of Summit's directors are anticipated to hold 3.46% of the equity interest and 3.46% of the voting power in YS Biopharma immediately after the Business Combination, assuming no redemptions by Summit Public Shareholders and there are no Dissenting Summit Shareholders (or 4.26% of the equity interest and 4.26% of the voting power in YS Biopharma immediately after the Business Combination, assuming 100% redemption by Summit Public Shareholders);
- the fact that the Sponsor paid an aggregate of \$25,000 for the 5,750,000 Founder Shares currently owned by the Sponsor, Summit's independent directors and Forward Purchase Investors and such securities will have a significantly higher value after the Business Combination. As of February 2, 2023, the most recent practicable date prior to the date of this proxy statement/prospectus, the aggregate market value of these shares, if unrestricted and freely tradable, would be \$58,190,000, based upon a closing price of \$10.12 per Summit Public Share on Nasdaq. The Founder Shares are expected to be worthless if the Business Combination or another business combination is not completed by the Final Redemption Date because the holders are not entitled to participate in any redemption or distribution of proceeds in the Trust Account with respect to such shares;
- the fact that Sponsor paid \$6,000,000 to purchase an aggregate of 6,000,000 Summit Private Warrants, each exercisable to purchase one Summit Public Share at \$11.50, subject to adjustment, at a price of \$1.00 per warrant, and those warrants would be worthless—and the entire \$6,000,000 warrant investment would be lost—if the Business Combination or another business combination is not consummated by the Final Redemption Date. As of February 2, 2023, the most recent practicable date prior to the date of this proxy statement/prospectus, the aggregate market value of these Summit Private Warrants, if unrestricted and freely tradable, would be \$1,664,400, based upon a closing price of \$0.2774 per Summit Public Warrant on Nasdaq;
- the fact that, given the differential in the purchase price that the Sponsor paid for the Founder Shares and the purchase price that the Sponsor paid for the Summit Private Warrants as compared to the price of the Summit Public Shares and Summit Public Warrants and the substantial number of YS Biopharma Ordinary Shares that the Sponsor and these directors will receive upon conversion of the Founder Shares and Summit Private Warrants, the Sponsor and these directors can earn a positive return on their investment, even if other Summit shareholders have a negative return in their investment in YS Biopharma;
- the fact that Sponsor and Summit's directors and officers have agreed to waive their rights to liquidating distributions from the Trust Account with respect to any Founder Shares held by them if Summit fails to complete a business combination by the Final Redemption Date;

- the fact that the Business Combination Agreement provides for continued indemnification of Summit’s directors and officers and the continuation of Summit’s directors’ and officers’ liability insurance after the Business Combination (i.e., a “tail policy”);
- the fact that Sponsor and Summit’s directors and officers and their affiliates are entitled to reimbursement of out-of-pocket expenses incurred by them in connection with certain activities on Summit’s behalf, such as identifying and investigating possible business targets and business combinations. However, if Summit fails to consummate a business combination within the required period, they will not have any claim against the Trust Account for reimbursement. Accordingly, Summit may not be able to reimburse these expenses if the Business Combination or another business combination is not completed by the Final Redemption Date. That being said, the Sponsor and Summit’s directors and officers and their affiliates had not incurred any unpaid reimbursable expenses as of the date of this proxy statement/prospectus;
- the fact that the Sponsor will benefit from the completion of a business combination and may be incentivized to complete an acquisition of a less favorable target company or on terms less favorable to shareholders rather than liquidate;
- the fact that if the Trust Account is liquidated, including in the event Summit is unable to complete a business combination by the Final Redemption Date, the Sponsor has agreed to indemnify Summit to ensure that the proceeds in the Trust Account are not reduced below \$10.00 per Summit Public Share, or such lesser per Summit Public Share amount as is in the Trust Account on the liquidation date, by the claims of prospective target businesses with which Summit has discussed entering into a transaction agreement or claims of any third party for services rendered or products sold to Summit (other than Summit’s independent registered public accounting firm), but only if such a vendor or target business has not executed a waiver of any and all rights to seek access to the Trust Account; and
- the fact that the Summit Articles contain a waiver of the corporate opportunity doctrine. With such waiver, there could be business combination targets that maybe suitable or worth consideration for a combination with Summit but not offered due to a Summit director’s duties to another entity. Summit does not believe that the potential conflict of interest relating to the waiver of the corporate opportunities doctrine in the Summit Articles impacted its search for an acquisition target and Summit was not prevented from reviewing any opportunities as a result of such waiver;
- the fact that HK Yisheng, a subsidiary of YS Biopharma, entered into the Facility Agreement with, among other parties, R-Bridge Investment Three Pte. Ltd, as original lender, and R-Bridge Healthcare Fund L.P., as original agent. Mr. Wei Fu, the Honorary Chairman and Senior Advisor of Summit and one of the managers of the Sponsor, is the sole director of R-Bridge and one of the investment committee members of R-Bridge Fund. Pursuant to the Facility Agreement, (i) RBridge made available to YS Biopharma a term loan facility in an aggregate amount of \$40,000,000, all of which was outstanding as of the date hereof; (ii) the facility and commitment under the Facility Agreement will be immediately cancelled and all of the outstanding loans, together with accrued interest and other amounts will become immediately due and payable if a listing, admission to trading, flotation or public offering of any shares of YS Biopharma (including upon or as a result of any direct or indirect merger, consolidation or takeover) has not occurred by October 31, 2023 or a later day as determined under the Facility Agreement; and (iii) consents from the lender(s) whose commitments aggregate more than 2/3 of the total amount then outstanding are required to approve certain transactions, including the Business Combination Agreement.
- the fact that Mr. Bo Tan, a current director of Summit, is expected to become a director of YS Biopharma and in such case would be compensated as a director of YS Biopharma.

For additional information, see the section entitled “The Business Combination Proposal — Interests of Summit’s Directors, Officers and the Sponsor in the Business Combination.”

The personal and financial interests of Summit’s directors and officers may have influenced their motivation in identifying and selecting YS Biopharma as a business combination target, completing an initial business combination with YS Biopharma and influencing the operation of the business following the initial business combination. In considering the recommendations of the Summit Board to vote for the Business Combination Proposal, the Merger Proposal and other Proposals, you should consider these interests.

***The exercise of Summit's directors' discretion in agreeing to changes or waivers in the terms of the Business Combination may result in a conflict of interest when determining whether such changes to the terms of the Business Combination or waivers of conditions are appropriate and in Summit's best interest.***

In the period leading up to the Closing of the Business Combination, events may occur that, pursuant to the Business Combination Agreement, would require Summit to agree to amend the Business Combination Agreement, to consent to certain actions taken by YS Biopharma or to waive rights that Summit is entitled to under the Business Combination Agreement. Such events could arise because of changes in the course of YS Biopharma's business, a request by YS Biopharma to undertake actions that would otherwise be prohibited by the terms of the Business Combination Agreement or the occurrence of other events that would have a material adverse effect on YS Biopharma's business or could entitle Summit to terminate the Business Combination Agreement. In any of such circumstances, it would be at Summit's discretion, acting through the Summit Board, to grant its consent or waive those rights; provided that under the terms of the Business Combination Agreement, such consent or waiver in certain cases is not to be unreasonably withheld. The existence of financial and personal interests of one or more of the directors may result in conflicts of interest on the part of such director(s) between what he, she or they may believe is best for Summit and what he, she or they may believe is best for himself, herself or themselves in determining whether or not to take the requested action. As of the date of this proxy statement/prospectus, Summit does not believe there will be any changes or waivers that Summit's directors and officers would be likely to make after shareholder approval of the Business Combination Proposal, the Merger Proposal and the other Proposals have been obtained. While certain changes could be made without further shareholder approval, Summit will circulate a new or amended proxy statement/prospectus and resolicit Summit shareholders if changes to the terms of the transaction that would have a material impact on its shareholders are required prior to the vote on the Business Combination Proposal, the Merger Proposal and the other Proposals. As a matter of Cayman Islands law, the directors of Summit are under a fiduciary duty to act in the best interest of Summit.

***We may be forced to close the Business Combination even if we determine it is no longer in Summit shareholders' best interest.***

Summit Public Shareholders are protected from a material adverse event of YS Biopharma arising between the date of the Business Combination Agreement and the date of the Extraordinary General Meeting, primarily by the right to redeem their Summit Public Shares for a pro rata portion of the funds held in the Trust Account, calculated as of two business days prior to the consummation of the Business Combination. If a material adverse event were to occur after approval of the Business Combination Proposal, the Merger Proposal and other Proposals at the Extraordinary General Meeting, Summit may be forced to close the Business Combination even if it determines it is no longer in its shareholders' best interest to do so (as a result of such material adverse event), which could have a significant negative impact on Summit's business, financial condition or results of operations.

***The Initial Shareholders agreed to vote in favor of the Business Combination, regardless of how Summit Public Shareholders vote.***

The Initial Shareholders have agreed to vote all of their Founder Shares in favor of all the proposals being presented at the Extraordinary General Meeting, including the Business Combination Proposal and the transactions contemplated thereby (including the Mergers). In addition, the Sponsor and each director and officer of Summit may also, from time to time, purchase Summit Public Shares before the Business Combination. As a result, the agreement by the Initial Shareholders to vote in favor of the Business Combination Proposal and the Merger Proposal will increase the likelihood that Summit will receive the requisite shareholder approval for such proposals.

***Summit is dependent upon its directors and officers and their loss could adversely affect Summit's ability to complete the Business Combination.***

Summit's operations are dependent upon a relatively small group of individuals and, in particular, its directors and officers. Summit's ability to complete its Business Combination depends on the continued service of its directors and officers. Summit does not have an employment agreement with, or key-man insurance on the life of, any of its officers or directors.

The unexpected loss of the services of one or more of its directors or officers could have a detrimental effect on Summit's ability to consummate the Business Combination.

***Summit's directors and officers will allocate their time to other businesses, thereby causing conflicts of interest in their determination as to how much time to devote to Summit's affairs. This conflict of interest could have a negative impact on Summit's ability to complete the Business Combination.***

Summit's directors and officers are not required to, and may not, commit their full time to its affairs, which may result in a conflict of interest in allocating their time between Summit's operations and the closing of the Business Combination, on the one hand, and their other business endeavors. Summit's directors and officers are not obligated to contribute any specific number of hours per week to Summit's affairs and may also serve as officers or board members for other entities. If its officers' and directors' other business affairs require them to devote time to such other affairs, this may have a negative impact on Summit's ability to complete the Business Combination.

***Past performance by Mr. Bo Tan, Mr. Ken Poon or entities affiliated with Summit or its Sponsor, including its management team, may not be indicative of future performance of an investment in YS Biopharma.***

Past performance by Mr. Bo Tan, Mr. Ken Poon or entities affiliated with Summit or its Sponsor, including its management team ("Summit Affiliated Persons") is not a guarantee of success with respect to the Business Combination. You should not rely on the historical record of Summit Affiliated Persons as indicative of the future performance of an investment in YS Biopharma or the returns YS Biopharma will, or is likely to, generate going forward.

***Following the Business Combination, YS Biopharma may redeem YS Biopharma Warrants held by holders other than the Sponsor or its permitted transferees prior to their exercise at a time that is disadvantageous to the holders of such YS Biopharma Warrants.***

The Summit Private Warrants (including the Summit Class A Ordinary Shares issuable upon exercise of the Summit Private Warrants) are not transferable, assignable or salable until 30 days after the completion of the Business Combination (except, among other limited exceptions, to Summit's officers and directors and other persons or entities affiliated with the Sponsor), and they will not be redeemable (except as described under "Description of YS Biopharma Securities — Warrants") so long as they are held by the Sponsor or its permitted transferees. The Sponsor, or its permitted transferees, have the option to exercise the Summit Private Warrants for cash or on a "cashless" basis. Otherwise, the Summit Private Warrants have terms and provisions that are identical to those of the Summit Public Warrants, including as to exercise price, exercisability and exercise period. If the Summit Private Warrants are held by holders other than the Sponsor or its permitted transferees, the Summit Private Warrants will be redeemable by Summit (or YS Biopharma after the consummation of the Business Combination) in all redemption scenarios and exercisable by the holders on the same basis as the Summit Public Warrants.

Upon the consummation of the Business Combination, each Summit Warrant outstanding immediately prior will cease to be a warrant with respect to Summit Public Shares and be assumed by YS Biopharma and converted into a YS Biopharma Warrant entitling the holder thereof to purchase such number of YS Biopharma Ordinary Share on a one-on-one basis. Each YS Biopharma Warrant will otherwise continue to have and be subject to substantially the same terms and conditions as were applicable to such Summit Warrant immediately prior to the consummation of the Business Combination (including any repurchase rights and cashless exercise provisions).

Following the Business Combination, YS Biopharma may redeem public YS Biopharma Warrants prior to their exercise at a time that is disadvantageous to the holders of such YS Biopharma Warrants, thereby making such warrants worthless. More specifically:

- YS Biopharma will have the ability to redeem outstanding YS Biopharma Warrants at any time after they become exercisable and prior to their expiration, at a price of \$0.01 per warrant, provided that the last reported sales price of YS Biopharma Ordinary Shares equals or exceeds \$18.00 per share (as adjusted for capitalization, share dividends, split-up and the like) for any 20 trading days within a 30 trading-day period ending on the third trading day prior to proper notice of such redemption and provided that certain other conditions are met.



- YS Biopharma will also have the ability to redeem outstanding YS Biopharma Warrants at any time after they become exercisable and prior to their expiration, at a price of \$0.10 per warrant upon a minimum of 30 days' prior written notice of redemption provided that the last reported sales price of YS Biopharma Ordinary Shares equals or exceeds \$10.00 per share (as adjusted for capitalization, share dividends, split-up and the like) for any 20 trading days within a 30 trading-day period ending on the third trading day prior to proper notice of such redemption and provided that certain other conditions are met, including that holders of the YS Biopharma Warrants will be able to exercise their YS Biopharma Warrants prior to redemption for a number of YS Biopharma Ordinary Shares determined based on the redemption date and the fair market value of the YS Biopharma Ordinary Shares. Please see the section entitled "Description of YS Biopharma Securities — Warrants." The value received upon exercise of the YS Biopharma Warrants (1) may be less than the value the holders would have received if they had exercised their YS Biopharma Warrants at a later time where the underlying share price is higher and (2) may not compensate the holders for the value of the YS Biopharma Warrants, including because the number of YS Biopharma Ordinary Shares received is capped at 0.361 YS Biopharma Ordinary Shares per warrant (subject to adjustment) irrespective of the remaining life of the YS Biopharma Warrants.

In each case, YS Biopharma may only call the YS Biopharma Warrants for redemption upon a minimum of 30 days' prior notice of redemption.

Redemption of the outstanding YS Biopharma Warrants could force holders of the YS Biopharma Warrants to (a) exercise YS Biopharma Warrants and pay the exercise price therefor at a time when it may be disadvantageous for such holders to do so, (b) sell YS Biopharma Warrants at the then-current market price when they might otherwise wish to hold their YS Biopharma Warrants or (c) accept the nominal redemption price which, at the time the outstanding YS Biopharma Warrants are called for redemption, is likely to be substantially less than the market value of the YS Biopharma Warrants.

***Shareholder litigation could prevent or delay the closing of the Business Combination or otherwise negatively impact business, operating results and financial condition.***

Summit may incur additional costs in connection with the defense or settlement of any shareholder litigation in connection with the proposed Business Combination. Litigation may adversely affect Summit's ability to complete the proposed Business Combination. Summit could incur significant costs in connection with any such litigation lawsuits, including costs associated with the indemnification of obligations to Summit's directors. Consequently, if a plaintiff were to secure injunctive or other relief prohibiting, delaying or otherwise adversely affecting Summit's ability to complete the proposed Business Combination, then such injunctive or other relief may prevent the proposed Business Combination from becoming effective within the expected timeframe or at all.

***The COVID-19 pandemic triggered an economic crisis which may delay or prevent the consummation of the Business Combination.***

The COVID-19 pandemic triggered an economic crisis which may delay or prevent the consummation of the Business Combination. A coronavirus (COVID-19) outbreak was reported in December 2019 and was declared a pandemic by the World Health Organization in March 2020. The coronavirus has spread throughout the world and has resulted in unprecedented restrictions and limitations on operations of many businesses, educational institutions and governmental entities. Given the ongoing and dynamic nature of the COVID-19 pandemic, it is difficult to predict the impact on the business of Summit and YS Biopharma, and there is no guarantee that efforts by Summit and YS Biopharma to address the adverse impact of the COVID-19 pandemic will be effective. If Summit or YS Biopharma is unable to recover from a business disruption on a timely basis, the Business Combination and YS Biopharma's business and financial conditions and results of operations following the completion of the Business Combination would be adversely affected. The Business Combination may also be delayed and adversely affected by the coronavirus pandemic and become more costly. Each of Summit and YS Biopharma may also incur additional costs to remedy damages caused by such disruptions, which could adversely affect its financial condition and results of operations.

***Delays in completing the Business Combination may substantially reduce the expected benefits of the Business Combination.***

Satisfying the conditions to, and completion of, the Business Combination may take longer than, and could cost more than, Summit expects. Any delay in completing or any additional conditions imposed in order to

complete the Business Combination may materially adversely affect the benefits that Summit expects to achieve from the Business Combination.

***Summit may not have sufficient funds to consummate the Business Combination.***

As of September 30, 2022, Summit had \$70,097 of cash held outside the Trust Account. If Summit is required to seek additional capital, it may need to borrow funds from the Sponsor, directors, officers, their affiliates or other third parties to operate or may be forced to liquidate. Summit believes that the funds available to it outside of the Trust Account, together with funds available from loans from Sponsor, its affiliates or members of Summit's management team will be sufficient to allow it to operate for at least the period ending on the Final Redemption Date; however, Summit cannot assure you that its estimate is accurate, and the Sponsor, directors, officers and their affiliates are under no obligation to advance funds to Summit in such circumstances.

***The Business Combination may be subject to U.S. foreign investment regulations which may impose conditions on or limit certain investors' ability to purchase our stock or otherwise participate in the Business Combination, potentially making the stock less attractive to investors. Summit's future investments in or acquisitions of U.S. companies may also be subject to U.S. foreign investment regulations.***

Certain investments that involve the acquisition of, or investment in, a "U.S. business" by a non-U.S. individual or entity (a "foreign person") may be subject to review and approval by the Committee on Foreign Investment in the United States ("CFIUS"). Whether CFIUS has jurisdiction to review an acquisition or investment transaction depends on the nationality of the buyer or investor, the extent to which the target of the investment or acquisition is engaged in interstate commerce in the United States, and nature of the rights afforded to the buyer or investor in the target entity. For example, transactions that result in "control" of a U.S. business by a foreign investor always are subject to CFIUS jurisdiction. CFIUS also has jurisdiction to review non-control transactions that afford a foreign investor certain information and/or governance rights in a U.S. business that has a qualifying nexus to "critical technologies," "critical infrastructure" and/or "sensitive personal data" as those terms are defined in the CFIUS regulations. Foreign investments in U.S. businesses that deal in "critical technology" may be subject to mandatory pre-closing CFIUS filing requirements. Failure to make a CFIUS filing where one is required may subject the transacting parties to significant civil fines.

The Sponsor and all of the three managers of the Sponsor are "foreign persons" for CFIUS purposes. While YS Biopharma has only a limited nexus to the United States, CFIUS has broad discretion in determining whether a business is a "U.S. business" (i.e., an entity engaged in interstate commerce in the United States) under the CFIUS regulations. If CFIUS were to determine that YS Biopharma is a U.S. business, while the proposed Business Combination should not be subject to a mandatory filing requirement, CFIUS could nevertheless seek to review prior transactions involving new or existing foreign investors in Summit or YS Biopharma, or proposed transactions involving new foreign investors in Summit or YS Biopharma. Any informal inquiry or formal review or investigation of a transaction by CFIUS may have significant impacts on transaction certainty, timing, feasibility, and cost, among other things. CFIUS policies and practices are rapidly evolving, and in the event of a CFIUS review of a foreign acquisition or investment transaction, there can be no assurances that the foreign buyer or investor will be able to maintain, or proceed with, such investments on terms acceptable to such investors. For example, CFIUS could seek to impose limitations or restrictions on, or prohibit, investments by foreign investors (including, but not limited to, limits on purchasing our stock, limits on information sharing with such investors, requiring a voting trust, governance modifications, or forced divestiture, among other things).

Moreover, the process of a government review of a transaction, whether by CFIUS or other government body, could be lengthy and provide Summit or YS Biopharma with insufficient time to complete the Business Combination. If the Business Combination is not consummated by the Final Redemption Date because of delays associated with CFIUS or because the Business Combination is ultimately prohibited by CFIUS or another U.S. government entity, Summit would cease all operations except for the purpose of winding up and redeem all the Summit Public Shares and liquidate. See the section entitled "— If Summit is unable to complete this Business Combination, or another business combination, within the prescribed time frame, Summit would cease all operations except for the purpose of winding up and redeem all the Summit Public Shares and liquidate" below for more details.

***If Summit is unable to complete this Business Combination, or another business combination, within the prescribed time frame, Summit would cease all operations except for the purpose of winding up and redeem all the Summit Public Shares and liquidate.***

Summit must complete its initial business combination by the Final Redemption Date. If Summit has not completed this Business Combination, or another business combination, within such time period, Summit will: (i) cease all operations except for the purpose of winding up; (ii) as promptly as reasonably possible but not more than ten business days thereafter, redeem the Summit Public Shares, at a per-share price, payable in cash, equal to the aggregate amount then on deposit in the Trust Account, including interest earned on the funds held in the Trust Account and not previously released to Summit (less taxes payable and up to \$100,000 of interest to pay dissolution expenses), divided by the number of the then-outstanding Summit Public Shares, which redemption will completely extinguish Summit Public Shareholders' rights as shareholders (including the right to receive further liquidation distributions, if any); and (iii) as promptly as reasonably possible following such redemption, subject to the approval of Summit's remaining shareholders and the Summit Board, liquidate and dissolve, subject in each case to Summit's obligations under Cayman Islands law to provide for claims of creditors and the requirements of other applicable law. The Summit Articles provide that, if Summit voluntarily winds up for any other reason prior to the consummation of its initial business combination, it will follow the foregoing procedures with respect to the liquidation of the Trust Account as promptly as reasonably possible but not more than ten business days thereafter, subject to applicable Cayman Islands law. In either such case, Summit Public Shareholders may receive only \$10.00 per share, or less than \$10.00 per share, on the redemption of their shares, and Summit Warrants will expire worthless.

***If, before distributing the proceeds in the Trust Account to Summit Public Shareholders, Summit files a bankruptcy or insolvency petition or an involuntary bankruptcy or insolvency petition is filed against it that is not dismissed, the claims of creditors in such proceeding may have priority over the claims of its shareholders, even for funds in the Trust Account and the per-share amount that would otherwise be received by its shareholders in connection with its liquidation may be reduced.***

If, before distributing the proceeds in the Trust Account to Summit Public Shareholders, Summit files a bankruptcy or insolvency petition or an involuntary bankruptcy or insolvency petition is filed against it that is not dismissed, the proceeds held in the Trust Account could be subject to applicable bankruptcy or insolvency law, and may be included in Summit's bankruptcy or insolvency estate and subject to the claims of third parties with priority over the claims of its shareholders. To the extent any bankruptcy or insolvency claims deplete the Trust Account, the per-share amount that would otherwise be received by shareholders in connection with Summit's liquidation may be reduced.

***If the Adjournment Proposal is not approved, and an insufficient number of votes have been obtained to authorize the consummation of the Business Combination, the Summit Board will not have the ability to adjourn the Extraordinary General Meeting to a later date in order to solicit further votes, and, therefore, the Business Combination will not be approved.***

The Summit Board is seeking approval to adjourn the Extraordinary General Meeting to a later date or dates if, at the Extraordinary General Meeting, based upon the tabulated votes, there are insufficient votes to approve the consummation of the Business Combination or if holders of Summit Public Shares have elected to redeem an amount of Summit Public Shares such that the minimum available cash condition contained in the Business Combination Agreement would not be satisfied. If the Adjournment Proposal is not approved, the Summit Board will not have the ability to adjourn the Extraordinary General Meeting to a later date and, therefore, will not have more time to solicit votes to approve the consummation of the Business Combination. In such an event, the Business Combination would not be completed.

***If third parties bring claims against Summit, the proceeds held in the Trust Account could be reduced and the per-share redemption amount received by shareholders may be less than \$10.00 per share.***

Summit's placing of funds in the Trust Account may not protect those funds from third-party claims against it. Although it will seek to have all vendors, service providers, and other entities with which it does business execute agreements with it waiving any right, title, interest or claim of any kind in or to any monies held in the Trust Account for the benefit of Summit Public Shareholders, such parties may not execute such agreements,

or even if they execute such agreements, they may not be prevented from bringing claims against the Trust Account, including, but not limited to, fraudulent inducement, breach of fiduciary responsibility or other similar claims, as well as claims challenging the enforceability of the waiver, in each case in order to gain advantage with respect to a claim against Summit's assets, including the funds held in the Trust Account. If any third party refuses to execute an agreement waiving such claims to the monies held in the Trust Account, Summit's management will perform an analysis of the alternatives available to it and will only enter into an agreement with a third party that has not executed a waiver if management believes that such third party's engagement would be significantly more beneficial to us than any alternative.

Examples of possible instances where Summit may engage a third party that refuses to execute a waiver include the engagement of a third-party consultant whose particular expertise or skills are believed by management to be significantly superior to those of other consultants that would agree to execute a waiver or in cases where management is unable to find a service provider willing to execute a waiver. In addition, there is no guarantee that such entities will agree to waive any claims they may have in the future as a result of, or arising out of, any negotiations, contracts or agreements with us and will not seek recourse against the Trust Account for any reason. Upon the exercise of a redemption right in connection with the Business Combination, Summit will be required to provide for payment of claims of creditors that were not waived that may be brought against Summit within the ten years following redemption. Accordingly, the per-share redemption amount received by Summit Public Shareholders could be less than the \$10.00 per share initially held in the Trust Account, due to claims of such creditors. Pursuant to a letter agreement between Summit, Sponsor, and its directors and officers, Sponsor has agreed that it will be liable to Summit if and to the extent any claims by a third party (other than its independent auditors) for services rendered or products sold to it, reduce the amounts in the Trust Account to below the lesser of (i) \$10.00 per share and (ii) the actual amount per share held in the Trust Account as of the date of the liquidation of the Trust Account if less than \$10.00 per share due to reductions in the value of the trust assets, in each case net of the interest that may be withdrawn to pay its tax obligations; provided, that, such liability will not apply to any claims by a third party that executed a waiver of any and all rights to seek access to the Trust Account nor will it apply to any claims under Summit's indemnity of the underwriters of its IPO against certain liabilities, including liabilities under the Securities Act. Moreover, in the event that an executed waiver is deemed to be unenforceable against a third party, Sponsor will not be responsible to the extent of any liability for such third-party claims.

However, Summit has not asked Sponsor to reserve for such indemnification obligations, nor has Summit independently verified whether Sponsor has sufficient funds to satisfy its indemnity obligations and Summit believes that Sponsor's only assets are securities of Summit. Therefore, Summit cannot assure you that Sponsor would be able to satisfy those obligations. As a result, if any such claims were successfully made against the Trust Account, the funds available for the Business Combination and redemptions could be reduced to less than \$10.00 per share. In such event, Summit may not be able to complete the Business Combination, and you would receive such lesser amount per share in connection with any redemption of your Summit Public Shares. None of Summit's officers or directors will indemnify Summit for claims by third parties including claims by vendors and prospective target businesses.

***If, after Summit distributes the proceeds in the Trust Account to Summit Public Shareholders, Summit files a bankruptcy or insolvency petition or an involuntary bankruptcy or insolvency petition is filed against it that is not dismissed, a bankruptcy or insolvency court may seek to recover such proceeds, and the members of the Summit Board may be viewed as having breached their fiduciary duties to its creditors, thereby exposing the members of its board of directors and Summit to claims of punitive damages.***

If Summit files a bankruptcy or insolvency petition or an involuntary bankruptcy or insolvency petition is filed against it that is not dismissed, any distributions received by shareholders could be viewed under applicable debtor/creditor and/or bankruptcy or insolvency laws as either a "preferential transfer" or a "fraudulent conveyance." As a result, a bankruptcy or insolvency court could seek to recover some or all amounts received by Summit shareholders. In addition, the Summit Board may be viewed as having breached its fiduciary duty to its creditors and/or having acted in bad faith, thereby exposing itself and Summit to claims of punitive damages, by paying Summit Public Shareholders from the Trust Account prior to addressing the claims of creditors.

***The Business Combination may be completed even though material adverse effects may result from the announcement of the Business Combination, industry-wide changes and other causes.***

In general, either Summit or YS Biopharma can refuse to complete the Business Combination if there is a material adverse effect affecting the other party between the signing date of the Business Combination Agreement and the planned closing. However, certain types of changes do not permit either party to refuse to complete the Business Combination, even if such change could be said to have a material adverse effect on YS Biopharma, including, among others, the following events (except, in some cases, where the change has a disproportionate effect on a party):

- (a) any change in applicable laws or U.S. GAAP or any interpretation thereof following the date of the Business Combination Agreement;
- (b) any change in interest rates or economic, political, business or financial market conditions generally;
- (c) the taking or refraining from taking of any action expressly required to be taken or refrained from being taken under the Business Combination Agreement;
- (d) any natural disaster (including hurricanes, storms, tornados, flooding, earthquakes, volcanic eruptions or similar occurrences), epidemic or pandemic (including any COVID-19 measures or any change in such COVID-19 measures or interpretations following the date of the Business Combination Agreement), acts of nature or change in climate;
- (e) any acts of terrorism or war, the outbreak or escalation of hostilities, geopolitical conditions, local, national or international political conditions, riots or insurrections;
- (f) any failure in and of itself of YS Biopharma and any of its subsidiaries to meet any projections or forecasts (provided, however, that this exception shall not prevent or otherwise affect a determination that any change, effect or development underlying such change has resulted in or contributed to a Company Material Adverse Effect (as defined in the Business Combination Agreement));
- (g) any event, state of facts, development, change, circumstance, occurrence or effect generally applicable to the industries or markets in which YS Biopharma or any of its subsidiaries operate;
- (h) any action taken by, or at the written request of Summit;
- (i) the announcement of the Business Combination Agreement and the Merger and each of the other transactions contemplated under the Business Combination Agreement and related agreements, including any termination of, reduction in or similar adverse impact (but in each case only to the extent attributable to such announcement or consummation) on YS Biopharma's and its subsidiaries' relationships, contractual or otherwise, with any governmental authority, third parties or other person;
- (j) any matter set forth on, or deemed to be incorporated in the Company Disclosure Letter (as defined in the Business Combination Agreement);
- (k) any event, state of facts, development, change, circumstance, occurrence or effect that is cured by YS Biopharma prior to the Closing; or
- (l) any worsening of the event, state of facts, development, change, circumstance, occurrence or effect referred to in (a), (b), (d), (e), (g) or (j) above to the extent existing as of the date of the Business Combination Agreement.

Furthermore, Summit or YS Biopharma may waive the occurrence of a material adverse effect affecting the other party. If a material adverse effect occurs and the parties still complete the Business Combination, YS Biopharma's share price may suffer.

***Subsequent to the completion of the Business Combination, YS Biopharma may be required to take write-downs or write-offs, restructure its operations, or incur unanticipated losses, impairment or other charges or liabilities that could have a significant negative effect on its financial condition, results of operations and the price of YS Biopharma Securities, which could cause Summit shareholders to lose some or all of their investment.***

Although Summit has conducted due diligence on YS Biopharma, Summit cannot assure you that this diligence identified all material issues that may be present with the business of YS Biopharma. Summit cannot

rule out that factors outside of the target business and outside of its control will not later arise. As a result of these factors, YS Biopharma may be forced to later write down or write off assets, restructure its operations, or incur unanticipated losses or impairment or other charges or liabilities that could result in it reporting losses. Even if Summit's due diligence successfully identifies certain risks, unexpected risks may arise and previously known risks may materialize in a manner not consistent with Summit's preliminary risk analysis. Even though these charges may be non-cash items and not have an immediate impact on YS Biopharma's liquidity, the fact that YS Biopharma reports charges of this nature could contribute to negative market perceptions about the post-combination company or its securities. In addition, charges of this nature may cause YS Biopharma to be unable to obtain future financing on favorable terms or at all.

***During the interim period, Summit is prohibited from entering into certain transactions that might otherwise be beneficial to Summit or its shareholders.***

Until the earlier of consummation of the Business Combination or termination of the Business Combination Agreement, Summit is subject to certain limitations on the operations of its business, including restrictions on its ability to merge, consolidate or amalgamate with or into, or acquire (by purchasing a substantial portion of the assets of or equity in, or by any other manner ) any entity other than YS Biopharma, as summarized under the section entitled "The Business Combination Agreement — Covenants — Covenants of Summit and the Merger Subs." The limitations on Summit's conduct of its business during this period could have the effect of delaying or preventing other strategic transactions and may, in some cases, make it impossible to pursue business opportunities that are available only for a limited time.

***The Business Combination remains subject to conditions that Summit cannot control and if such conditions are not satisfied or waived, the Business Combination may not be consummated.***

The Business Combination is subject to a number of conditions. There are no assurances that all conditions to the Business Combination will be satisfied or that the conditions will be satisfied in the time frame expected. If the conditions to the Business Combination are not met (and are not waived, to the extent waivable), then either Summit or YS Biopharma may, subject to the terms and conditions of the Business Combination Agreement, terminate the Business Combination Agreement or amend the termination date upon which either Summit or YS Biopharma may terminate the Business Combination Agreement. See the section entitled "The Business Combination Proposal."

***A shareholder who has exercised Dissent Rights and followed the dissent procedure prescribed by the Cayman Islands Companies Act may subsequently lose their Dissent Rights following the Extraordinary General Meeting, including where completion of the Merger is delayed in order to invoke the exemption under Section 239 of the Cayman Islands Companies Act, in which event such dissenting shareholder would not receive cash for their Summit Shares and instead would only be entitled to receive the merger consideration and would become a shareholder of YS Biopharma upon consummation of the Business Combination.***

Holders of record of Summit Shares wishing to exercise Dissent Rights and make a demand for payment of the fair market value for his, her or its Summit Shares must give written objection to the First Merger to Summit prior to the shareholder vote at the Extraordinary General Meeting to approve the First Merger and follow the procedures set out in Section 238 of the Cayman Islands Companies Act. However, the Business Combination Agreement provides that, if any Summit shareholder exercises Dissent Rights, Summit shall in accordance with Section 238 of the Cayman Islands Companies Act promptly give written notice of the authorization of the First Merger (the "Authorization Notice") to each such Summit shareholder who has made a written objection, and unless Summit and YS Biopharma elect by agreement in writing to waive this provision in the Business Combination Agreement, no party shall be obligated to commence the completion of the Merger, and the Plan of First Merger shall not be filed with the Registrar of Companies of the Cayman Islands, until at least twenty days shall have elapsed since the date on which the Authorization Notice is given (being the period allowed for written notice of an election to dissent under Section 238 of the Cayman Islands Companies Act, as referred to in Section 239 of the Cayman Islands Companies Act). Section 239 of the Cayman Islands Companies Act states that no such dissenter rights shall be available in respect of shares of any class for which an open market exists on a recognized stock exchange or recognized interdealer quotation system at the expiry date of the period allowed for written notice of an election to dissent provided that the merger consideration constitutes inter alia shares of any company which at the effective date of the merger are

listed on a national securities exchange. In circumstances where completion of the Merger shall be delayed and the limitation under Section 239 of the Cayman Islands Companies Act is invoked, no Dissent Rights would be available to Summit shareholders, including those Summit shareholders who previously delivered a written objection to the Merger prior to the Extraordinary General Meeting and followed the procedures set out in Section 238 of the Cayman Islands Companies Act in full up to such date, and such holder's former Summit Shares will thereupon be deemed to have been converted into, and to have become exchangeable for, as of the First Merger Effective Time, the right to receive such fraction of a newly issued YS Biopharma Ordinary Share that is equal to the Exchange Ratio (subject to rounding) for each Summit Share, without interest thereon. Accordingly, Summit shareholders are not expected to ultimately have any appraisal or dissent rights in respect of their Summit Shares and the certainty provided by the redemption process may be preferable for Summit Public Shareholders wishing to exchange their Summit Public Shares for cash. See the section entitled "Appraisal Rights" for additional information.

***Summit shareholders may have limited remedies if their shares suffer a reduction in value following the Business Combination, and because Summit (and also YS Biopharma, the surviving company) is incorporated under the laws of the Cayman Islands, shareholders may face difficulties in protecting their interests, and a shareholder's ability to protect its rights through the U.S. federal courts may be limited.***

Any shareholders who choose to remain shareholders following the Business Combination could suffer a reduction in the value of their shares. Such shareholders are unlikely to have a remedy for such reduction in value, unless they are able to successfully claim that the reduction was due to the breach by Summit's officers or directors of a duty of care or other fiduciary duty, or if they are able to successfully bring a private claim under securities laws that the proxy/registration statement relating to the Business Combination contained an actionable material misstatement or material omission.

Summit and YS Biopharma are both exempted companies incorporated under the laws of the Cayman Islands. As a result, it may be difficult for their shareholders to effect service of process within the United States upon the directors or executive officers of Summit and YS Biopharma, or enforce judgments obtained in the United States courts against the directors or officers of Summit and YS Biopharma. Summit and YS Biopharma's Cayman Islands counsel are not aware of any reported class action having been brought in a Cayman Islands court. Derivative actions have been brought in the Cayman Islands courts, and the Cayman Islands courts have confirmed the availability for such actions.

The corporate affairs of Summit and YS Biopharma are governed by their respective amended and restated memorandum and articles of association, the Cayman Islands Companies Act and the common law of the Cayman Islands. The rights of shareholders to take action against the directors, actions by minority shareholders and the fiduciary responsibilities of the directors of Summit and YS Biopharma to each of Summit and YS Biopharma under Cayman Islands law are to a large extent governed by the common law of the Cayman Islands. The common law of the Cayman Islands is derived in part from comparatively limited judicial precedent in the Cayman Islands as well as from English common law, the decisions of whose courts are of persuasive authority, but are not binding on a court in the Cayman Islands. The rights of the shareholders of Summit and YS Biopharma and the fiduciary responsibilities of the directors of Summit and YS Biopharma under Cayman Islands law are not clearly established as what they would be under statutes or judicial precedent in some jurisdictions in the U.S. In particular, the Cayman Islands has a less developed body of securities laws as compared to the U.S., and certain states, such as Delaware, may have more fully developed and judicially interpreted bodies of corporate law. In addition, Cayman Islands companies may not have standing to initiate a shareholders derivative action in a Federal court of the United States.

We have been advised by our Cayman Islands legal counsel that it is uncertain whether the courts of the Cayman Islands will allow shareholders of Summit and YS Biopharma to originate actions in the Cayman Islands based upon securities laws of the U.S. In addition, there is uncertainty with regard to Cayman Islands law related to whether a judgment obtained from the U.S. courts under civil liability provisions of U.S. securities laws will be determined by the courts of the Cayman Islands as penal or punitive in nature. If such determination is made, the courts of the Cayman Islands will not recognize or enforce the judgment against a Cayman Islands company, such as Summit and YS Biopharma. As the courts of the Cayman Islands have yet to rule on making such a determination in relation to judgments obtained from U.S. courts under civil liability provisions of U.S. securities laws, it is uncertain whether such judgments would be enforceable in the Cayman

Islands. Although there is no statutory enforcement in the Cayman Islands of judgments obtained in the United States, the courts of the Cayman Islands will recognize and enforce a foreign money judgment of a foreign court of competent jurisdiction without retrial on the merits of the underlying dispute based on the principle that a judgment of a competent foreign court imposes upon the judgment debtor an obligation to pay the sum for which judgment has been given provided certain conditions are met. For a foreign judgment to be enforced in the Cayman Islands, such judgment must be final and conclusive and for a liquidated sum, and must not be in respect of taxes or a fine or penalty, inconsistent with a Cayman Islands judgment in respect of the same matter, impeachable on the grounds of fraud or obtained in a manner, or be of a kind the enforcement of which is, contrary to natural justice or the public policy of the Cayman Islands (awards of punitive or multiple damages may well be held to be contrary to public policy). The courts of the Cayman Islands will apply the rules of Cayman Islands private international law to determine whether the foreign court is a court of competent jurisdiction. A Cayman Islands Court may stay enforcement proceedings if concurrent proceedings are being brought elsewhere.

As a result of all of the above, public shareholders of Summit and YS Biopharma may have more difficulty in protecting their interests in the face of actions taken by management, members of the board of directors of Summit and YS Biopharma or controlling shareholders than they would as public shareholders of a U.S. company.

***Summit Warrants are accounted for as liabilities and the changes in value of Summit Warrants could have a material effect on Summit's financial results.***

Summit accounts for warrants as either equity-classified or liability-classified instruments based on an assessment of the warrant's specific terms and applicable authoritative guidance in ASC 480, Distinguishing Liabilities from Equity ("ASC 480") and ASC 815, Derivatives and Hedging ("ASC 815"). The assessment considers whether the warrants are freestanding financial instruments pursuant to ASC 480, meet the definition of a liability pursuant to ASC 480, and whether the warrants meet all of the requirements for equity classification under ASC 815, including whether the warrants are indexed to the company's own ordinary shares, among other conditions for equity classification. This assessment, which requires the use of professional judgment, is conducted at the time of warrant issuance and as of each subsequent quarterly period end date while the warrants are outstanding. As a result of the recurring fair value measurement, Summit's financial statements and results of operations may fluctuate quarterly, based on factors, which are outside of its control. Due to the recurring fair value measurement, Summit expects that it will recognize non-cash gains or losses on Summit Warrants each reporting period and that the amount of such gains or losses could be material.

***If the Mergers do not qualify as a "Reorganization" within the meaning of Section 368(a) of the Code, then the Mergers generally will be taxable to U.S. Holders.***

To qualify as a Reorganization, the Mergers must satisfy certain requirements, some of which are based on factual determinations, and actions or events after the Mergers could adversely affect such qualification. One such requirement is that the acquiring corporation, directly or indirectly through certain controlled corporations, either continue a significant line of the acquired corporation's historic business or use a significant portion of the acquired corporation's historic business assets in a business, in each case, within the meaning of U.S. Treasury Regulations Section 1.368-1(d). However, due to the absence of guidance bearing directly on how the above rules apply in the case of an acquisition of a corporation like Summit that holds primarily investment-type assets, the qualification of the Mergers as a Reorganization is subject to significant uncertainty, and is therefore not capable of being the subject of a representation regarding its tax treatment. The closing of the Business Combination is not conditioned upon the receipt of an opinion of counsel that the Mergers will qualify as a Reorganization, and neither Summit nor YS Biopharma intends to request a ruling from the IRS regarding the U.S. federal income tax treatment of the Mergers. Accordingly, no assurance can be given that the IRS will not treat the Mergers as taxable transactions and challenge the qualification of the Mergers as a Reorganization or that a court will not sustain such a challenge by the IRS. U.S. Holders of Summit Securities are urged to consult their tax advisors regarding the proper U.S. federal income tax treatment of the Mergers, including with respect to their qualification as a Reorganization.

If the Mergers do not qualify as a Reorganization, then a U.S. Holder generally will recognize gain or loss in an amount equal to the difference between the fair market value (as of the closing date of the Mergers) of YS



Biopharma Ordinary Shares and YS Biopharma Warrants received in the Mergers, over such holder's aggregate adjusted tax basis in the corresponding Summit Public Shares and Summit Public Warrants surrendered by such holder in the Mergers. Even if the Mergers otherwise qualify as a Reorganization, U.S. Holders may be required to recognize gain (but not loss) in the Mergers under the PFIC rules, as described in more detail below under the section entitled "Material Tax Considerations — U.S. Federal Income Tax Considerations to U.S. Holders — Passive Foreign Investment Company Rules."

The tax consequences of the Mergers are complex and will depend on each U.S. Holder's particular circumstances. For a more detailed discussion of the U.S. federal income tax considerations of the Mergers for U.S. Holders, see the section entitled "Material Tax Considerations — U.S. Federal Income Tax Considerations to U.S. Holders — Tax Treatment of The Mergers." U.S. Holders exchanging their Summit Public Shares and/or Summit Public Warrants in the Mergers should consult their tax advisors to determine the tax consequences thereof.

***You will not have any rights or interests in funds from the Trust Account, except under certain limited circumstances. To liquidate your investment, therefore, you may be forced to redeem or sell your Summit Public Shares or Summit Public Warrants, potentially at a loss.***

Summit Public Shareholders will be entitled to receive funds from the Trust Account only upon the earlier to occur of: (i) Summit's completion of the Business Combination, and then only in connection with those Summit Public Shares that such shareholder properly elected to redeem, subject to the limitations described herein, (ii) the redemption of any Summit Public Shares properly tendered in connection with a shareholder vote to amend the Summit Articles (A) to modify the substance or timing of Summit's obligation to provide holders of Summit Public Shares the right to have their shares redeemed in connection with a business combination or to redeem 100% of the Summit Public Shares if Summit does not complete a business combination within 24 months after the date of the closing of the IPO, or (B) with respect to any other provision relating to the rights of holders of Summit Public Shares, and (iii) the redemption of Summit Public Shares if Summit is unable to complete a business combination by the Final Redemption Date, subject to applicable law and as further described herein. Summit Public Shareholders may be forced to wait beyond the Final Redemption Date, before they receive funds from the Trust Account. In no other circumstances will Summit shareholders have any right or interest of any kind in the Trust Account. Accordingly, to liquidate your investment, you may be forced to sell your Summit Public Shares or Summit Public Warrants, potentially at a loss.

***Summit Public Shareholders who wish to redeem their Summit Public Shares for a pro rata portion of the Trust Account must comply with specific requirements for redemption, which may make it difficult for them to exercise their redemption rights prior to the deadline. If Summit Public Shareholders fail to comply with the redemption requirements specified in this proxy statement/prospectus, they will not be entitled to redeem their Summit Public Shares for a pro rata portion of the funds held in the Trust Account.***

Summit Public Shareholders who wish to redeem their Summit Public Shares for a pro rata portion of the Trust Account must (i) submit a written request to Continental, Summit's transfer agent, in which you request that Summit redeem all or a portion of your Summit Public Shares for cash, and identify yourself as the beneficial holder of the Summit Public Shares and provide your legal name, phone number and address; and (ii) either tender your share certificates (if any) to Continental, Summit's transfer agent, or deliver your Summit Public Shares to the transfer agent electronically using The Depository Trust Company's DWAC (Deposit/Withdrawal at Custodian) System, in each case at least two business days prior to the vote at the Extraordinary General Meeting. Any Summit Public Shareholder who fails to properly demand redemption of such shareholder's Summit Public Shares will not be entitled to convert his, her or its Summit Public Shares into a pro rata portion of the Trust Account. In addition, Summit will comply with the proxy rules when conducting redemptions in connection with the Business Combination. Despite Summit's compliance with these rules, if a shareholder fails to receive Summit's tender offer or proxy materials, as applicable, such shareholder may not become aware of the opportunity to redeem its Summit Public Shares. Furthermore, the proxy materials, as applicable, that Summit will furnish to holders of Summit Public Shares in connection with the Business Combination will describe the various procedures that must be complied with in order to validly redeem Summit Public Shares. In the event that a shareholder fails to comply with these procedures, his, her or its Summit Public Shares will not be redeemed.

***Summit does not have a specified maximum redemption threshold. The absence of such a redemption threshold may make it possible for Summit to complete a business combination with which a substantial majority of its shareholders do not agree.***

The Summit Articles do not provide a specified maximum redemption threshold, except that in no event will Summit redeem Summit Public Shares in an amount that would cause its net tangible assets to be less than \$5,000,001, such that Summit is not subject to the SEC's "penny stock" rules. This minimum net tangible asset amount is also required as an obligation to each party's obligation to consummate the Business Combination under the Business Combination Agreement. If the Business Combination is not consummated, Summit will not redeem any Summit Public Shares, all Summit Public Shares submitted for redemption will be returned to the holders thereof, and Summit instead may search for an alternate business combination.

***The grant and future exercise of registration rights may adversely affect the market price of YS Biopharma Ordinary Shares upon consummation of the Business Combination.***

Pursuant to the Shareholder Support Agreement entered into in connection with the Business Combination and which is described elsewhere in this proxy statement/prospectus, Sponsor and certain holders of YS Biopharma securities that entered into such agreement can each demand that YS Biopharma register their registrable securities and assist in underwritten takedown of such securities under certain circumstances and will each also have piggyback registration rights for these securities in connection with certain registrations of securities that YS Biopharma undertakes. In addition, following the consummation of the Business Combination, YS Biopharma is required to file and maintain an effective registration statement under the Securities Act covering such securities and certain other securities of YS Biopharma. Additionally, pursuant to the Shareholder Support Agreement, YS Biopharma must file a registration statement within 30 days after the consummation of the Business Combination registering a number of YS Biopharma Ordinary Shares as requested by other holders under the Shareholder Support Agreement.

The registration of these securities will permit the public sale of such securities subject to any contractual lock-up any such shareholder may have signed. The registration and availability of such a significant number of securities for trading in the public market may have an adverse effect on the market price of YS Biopharma Ordinary Shares post-Business Combination.

***If you or a "group" of shareholders of which you are a part are deemed to hold an aggregate of more than 15% of the Summit Public Shares issued in the IPO, you (or, if a member of such a group, all of the members of such group in the aggregate) will lose the ability to redeem all such shares in excess of 15% of the Summit Public Shares issued in the IPO.***

A shareholder, together with any of his, her or its affiliates or any other person with whom it is acting in concert or as a "group" (as defined under Section 13 of the Exchange Act) will be restricted from redeeming in the aggregate his, her or its Summit Public Shares or, if part of such a group, the group's Summit Public Shares, in excess of 15% of the Summit Public Shares included in the Units sold in the IPO. In order to determine whether a shareholder is acting in concert or as a group with another shareholder, Summit will require each shareholder seeking to exercise redemption rights to certify to Summit whether such shareholder is acting in concert or as a group with any other shareholder. Such certifications, together with other public information relating to share ownership available to Summit at that time, such as Schedule 13D, Schedule 13G and Section 16 filings under the Exchange Act, will be the sole basis on which Summit makes the above-referenced determination. Your inability to redeem any such excess Summit Public Shares will reduce your influence over Summit's ability to consummate the Business Combination and you could suffer a material loss on your investment in Summit if you sell such excess Summit Public Shares in open market transactions. Additionally, you will not receive redemption distributions with respect to such excess Summit Public Shares if Summit consummates the Business Combination. As a result, you will continue to hold that number of Summit Public Shares aggregating to more than 15% of the Summit Public Shares included in the Units sold in the IPO and, in order to dispose of such excess Summit Public Shares, would be required to sell your Summit Public Shares in open market transactions prior to the consummation of the Business Combination, potentially at a loss. There is no assurance that the value of such excess Summit Public Shares (or YS Biopharma Ordinary Shares received in exchange therefor) will appreciate over time following the Business Combination or that the market price of the Summit Public Shares will exceed the per-share redemption price. Notwithstanding the foregoing, shareholders may challenge Summit's determination as to whether a shareholder is acting in concert or as a group with another shareholder in a court of competent jurisdiction.

However, Summit shareholders' ability to vote all of their Summit Shares (including such excess Summit Public Shares) for or against the Business Combination Proposal and all other proposals presented at the Extraordinary General Meeting is not restricted by this limitation on redemption.

***There is no guarantee that a shareholder's decision whether to redeem its Summit Public Shares for a pro rata portion of the Trust Account will put the shareholder in a better future economic position.***

There is no assurance as to the price at which a Summit shareholder may be able to sell its Summit Public Shares (or YS Biopharma Ordinary Shares received in exchange therefor) in the future following the completion of the Business Combination or any alternative business combination. Certain events following the consummation of any initial business combination, including the Business Combination, may cause an increase in the share price, and may result in a lower value realized now than a Summit Public Shareholder might realize in the future had the shareholder not redeemed its Summit Public Shares. Similarly, if a Summit Public Shareholder does not redeem its Summit Public Shares, the shareholder will bear the risk of ownership of the YS Biopharma Ordinary Shares after the consummation of the Business Combination, and there can be no assurance that a shareholder can sell its shares in the future for a greater amount than the redemption price set forth in this proxy statement/prospectus. A Summit shareholder should consult the shareholder's tax and/or financial advisor for assistance on how this may affect his, her or its individual situation.

## EXTRAORDINARY GENERAL MEETING OF SUMMIT SHAREHOLDERS

### General

Summit is furnishing this proxy statement/prospectus to Summit Shareholders as part of the solicitation of proxies by the Summit Board for use at the Extraordinary General Meeting, which will be held at 9:00 a.m. Eastern Time, on March 1, 2023 at 35th Floor, Two Exchange Square, 8 Connaught Place Central, Hong Kong and virtually at <https://www.cstproxy.com/summithealthcarespac/2023>, and at any adjournment or postponement thereof. This proxy statement/prospectus is first being furnished to Summit Shareholders on or about [ ] in connection with the vote on the proposals described in this proxy statement/prospectus. This proxy statement/prospectus provides Summit Shareholders with information they need to know to be able to vote or instruct their vote to be cast at the Extraordinary General Meeting.

### Date, Time and Place

The Extraordinary General Meeting of Summit Shareholders be held at 9:00 a.m. Eastern Time, on March 1, 2023 at 35th Floor, Two Exchange Square, 8 Connaught Place Central, Hong Kong and virtually at <https://www.cstproxy.com/summithealthcarespac/2023>. You will be able to attend, vote your shares, view the list of shareholders entitled to vote at the Extraordinary General Meeting and submit your questions during the Extraordinary General Meeting via a live audio cast available at <https://www.cstproxy.com/summithealthcarespac/2023>. We are pleased to utilize virtual shareholder meeting technology to (i) provide ready access and cost savings for Summit Shareholders and Summit and (ii) to promote social distancing pursuant to guidance provided by the SEC due to COVID-19. The virtual meeting format allows attendance from any location in the world.

### Purpose of Summit Extraordinary General Meeting

At the Extraordinary General Meeting, Summit is asking holders of Summit Shares to:

- consider and vote upon the Business Combination Proposal;
- consider and vote upon the Merger Proposal (being presented to Summit’s shareholders separately in light of Cayman law requirements and for good governance practice); and
- if presented, consider and vote upon the Adjournment Proposal.

The approval of the Business Combination Proposal is a condition to the consummation of the Business Combination Transactions. If the Business Combination Proposal is not approved, the other proposals (except the Adjournment Proposal, as described below) shall not be presented to the Summit Shareholders for a vote.

### Recommendation of Summit Board of Directors FOR the Business Combination Proposal, the Merger Proposal, and the Adjournment Proposal

After careful consideration, Summit’s board of directors has unanimously approved the Business Combination and determined that the Business Combination Proposal, the Merger Proposal and the Adjournment Proposal are advisable and fair to and in the best interest of Summit and unanimously recommends that you vote or give instruction to vote “FOR” the Business Combination Proposal, “FOR” the Merger Proposal, and “FOR” the Adjournment Proposal, if presented.

When you consider the Summit Board’s recommendation of these proposals, you should keep in mind that Summit’s directors and officer have interests in the Business Combination that may conflict with, or are different from, your interests as a shareholder of Summit. See the section entitled “The Business Combination Proposal—Interests of Summit’s Directors, Officers and the Sponsor in the Business Combination” for a further discussion of these considerations.

### Record Date; Outstanding Shares; Shareholders Entitled to Vote

Summit has fixed the close of business on February 2, 2023, as the “Record Date” for determining Summit Shareholders entitled to notice of and to attend and vote at the Extraordinary General Meeting. If your Summit Shares are held in “street name” or are in a margin or similar account, you should contact your broker

or bank to ensure that votes related to the Summit Shares you beneficially own are properly counted. Summit Warrants do not have voting rights. As of the close of business on the Record Date, there were 20,000,000 Summit Public Shares and 5,750,000 Founder Shares issued and outstanding and entitled to vote. All of the Founder Shares are held by the Sponsor, Summit's directors and the Forward Purchase Investors. Each Summit Share is entitled to one vote per share at the Extraordinary General Meeting.

### **Quorum**

A quorum is the minimum number of Summit Shares that must be present to hold a valid meeting. A quorum shall be present at the Extraordinary General Meeting if one or more shareholders holding in the aggregate not less than one-third of the total issued and outstanding Summit Shares present in person physically or by virtual attendance or represented by proxy and entitled to vote at the Extraordinary General Meeting. As of the Record Date, 8,583,334 Summit Shares would be required to achieve a quorum.

### **Abstentions and Broker Non-Votes**

Proxies that are marked "abstain" and proxies relating to "street name" shares that are returned to Summit but marked by brokers as "not voted" will be treated as shares present for purposes of determining the presence of a quorum on all matters, but they will not be treated as shares voted on the matter. Under the rules of various national and regional securities exchanges, your broker, bank, or nominee cannot vote your shares with respect to non-discretionary matters unless you provide instructions on how to vote in accordance with the information and procedures provided to you by your broker, bank, or nominee. We believe all the proposals presented to the shareholders will be considered non-discretionary and therefore your broker, bank, or nominee cannot vote your shares without your instruction.

### **Vote Required**

The approval of the Business Combination Proposal will require an ordinary resolution under Cayman Islands law and the Summit Articles, being the affirmative vote of the holders of a majority of the issued and outstanding Summit Shares present in person physically or by virtual attendance or represented by proxy and entitled to vote at the Extraordinary General Meeting.

The approval of the Merger Proposal will require a special resolution under Cayman Islands law and the Summit Articles, being the affirmative vote of the holders of at least two-thirds of the issued and outstanding Summit Shares present in person physically or by virtual attendance or represented by proxy and entitled to vote at the Extraordinary General Meeting.

The approval of the Adjournment Proposal, if presented, will require an ordinary resolution under Cayman Islands law and the Summit Articles, being the affirmative vote of the holders of a majority of the issued and outstanding Summit Shares present in person physically or by virtual attendance or represented by proxy and entitled to vote at the Extraordinary General Meeting.

Brokers are not entitled to vote on the Business Combination Proposal, the Merger Proposal or the Adjournment Proposal absent voting instructions from the beneficial holder. An abstention or broker non-vote will be counted towards the quorum requirement but will not count as a vote cast at the Extraordinary General Meeting.

### **Voting Your Shares**

Voting on all resolutions at the Extraordinary General Meeting will be conducted by way of a poll rather than on a show of hands. On a poll, votes are counted according to the number of Summit Shares registered in each shareholder's name which are voted, with each Summit Share carrying one vote. Your proxy card shows the number of Summit Shares that you own.

If you are a holder of record of Summit Shares at close of business on the Record Date, there are two ways to vote your Summit Shares at the Extraordinary General Meeting:

- You can vote by completing, signing, dating and returning the enclosed proxy card in the pre-addressed postage paid envelope provided so as to be received by Summit no later than at 9:00 a.m. Eastern Time, on

February 27, 2023, being 48 hours before the time appointed for the holding of the Extraordinary General Meeting (or, in the case of an adjournment, no later than 48 hours before the time appointed for the holding of the adjourned meeting). If you vote by proxy card, your “proxy,” whose name is listed on the proxy card, will vote your Summit Shares as you instruct on the proxy card. If you sign and return the proxy card but do not give instructions on how to vote your Summit Shares, your Summit Shares will be voted as recommended by the Summit Board “FOR” the Business Combination Proposal, “FOR” the Merger Proposal and “FOR” the Adjournment Proposal, in each case, if presented to the Extraordinary General Meeting. Votes received after a matter has been voted upon at the Extraordinary General Meeting will not be counted; or

- You can attend the Extraordinary General Meeting virtually and vote electronically via the web portal during the Extraordinary General Meeting webcast. Go to <https://www.cstproxy.com/summithealthcarespac/2023>, enter the control number you received on your proxy card or notice of the meeting and click on the “Click here to register for the online meeting” link at the top of the page. Immediately prior to the start of the Extraordinary General Meeting, you will need to log back into the meeting site using your control number.

If you hold your Summit Shares in “street name”, which means your shares are held of record by a broker, bank or nominee, you should contact your broker or bank to ensure that votes related to the Summit Shares you beneficially own are properly counted. If you hold your Summit Shares in “street name” and you wish to attend the Extraordinary General Meeting virtually and vote, you must obtain a legal proxy from the shareholder of record and e-mail a copy (a legible photograph is sufficient) of your proxy to [proxy@continentalstock.com](mailto:proxy@continentalstock.com) no later than 72 hours prior to the Extraordinary General Meeting. Holders should contact their broker, bank or nominee for instructions regarding obtaining a proxy. Holders who e-mail a valid legal proxy will be issued a meeting control number that will allow them to register to attend and participate in the Extraordinary General Meeting. You will receive an e-mail prior to the meeting with a link and instructions for entering the Extraordinary General Meeting. “Street name” holders should contact Continental on or before 9:00 a.m. on February 26, 2023.

#### **Revoking Your Proxy**

If you are a holder of record of Summit Shares and you give a proxy, you may revoke it at any time before it is exercised by doing any one of the following:

- you may send another signed proxy card to Continental, Summit’s transfer agent, at the address set out elsewhere in this proxy statement/prospectus so that it is received no later than 48 hours before the time appointed for the holding of the Extraordinary General Meeting (or, in the case of an adjournment, no later than 48 hours before the time appointed for the holding of the adjourned meeting);
- you may notify the Summit Board in writing, prior to the vote at the Extraordinary General Meeting, that you have revoked your proxy; or
- you may attend the Extraordinary General Meeting virtually over the Internet by joining the live audio webcast and vote electronically through the web portal during the Extraordinary General Meeting, although your attendance alone will not revoke any proxy that you have previously given.

If you hold your Summit Shares in “street name,” you may submit new instructions on how to vote your shares by contacting your broker, bank or nominee.

#### **Who Can Answer Your Questions About Voting Your Shares**

If you are a shareholder and have any questions about how to vote or direct a vote in respect of your Summit Shares, you may call Advantage, Summit’s proxy solicitor, at 1-877-870-8565 or email at [ksmith@advantageproxy.com](mailto:ksmith@advantageproxy.com), or banks and brokers can call collect at 1-206-870-8565, or by email at [ksmith@advantageproxy.com](mailto:ksmith@advantageproxy.com).

#### **Redemption Rights**

Pursuant to the Summit Articles, in connection with the completion of the Business Combination, Summit Public Shareholders may elect to have their Summit Public Shares redeemed for cash at the applicable

redemption price per share calculated in accordance with the Summit Articles. For illustrative purposes, as of February 2, 2023, the Record Date, this redemption amount would have amounted to approximately \$10.1 per share. In this proxy statement/prospectus, these rights to demand redemption of the Summit Public Shares are sometimes referred to as “redemption rights.” Summit Public Shareholders may elect to exercise such redemption rights, regardless of whether they vote or, if they do vote, irrespective of whether they vote for or against the Business Combination Proposal, the Merger Proposal or the Adjournment Proposal.

If you are a Summit Public Shareholder and wish to exercise your right to have your Summit Public Shares redeemed, you must:

- submit a written request to Continental, Summit’s transfer agent, in which you (i) request that Summit redeem all or a portion of your Summit Public Shares for cash, and (ii) identify yourself as the beneficial holder of the Summit Public Shares and provide your legal name, phone number and address; and
- either tender your share certificates (if any) to Continental, Summit’s transfer agent, or deliver your Summit Public Shares to the transfer agent electronically using The Depository Trust Company’s DWAC (Deposit/Withdrawal at Custodian) System.

**Summit Public Shareholders must complete the procedures for electing to redeem their Summit Public Shares in the manner described above prior to 5:00 p.m. on February 27, 2023 (two business days prior to the vote at the Extraordinary General Meeting) in order for their Summit Public Shares to be redeemed.**

There is a nominal cost associated with the above-referenced tendering process and the act of certificating the shares or delivering them through the DWAC system. The transfer agent will typically charge the tendering broker a nominal amount and it would be up to the broker whether or not to pass this cost on to the redeeming shareholder. In the event the Business Combination is not consummated this may result in an additional cost to shareholders for the return of their shares.

If you hold the Summit Public Shares in “street name” you will have to coordinate with your broker or bank to have the Summit Public Shares you beneficially own certificated and delivered electronically.

Holders of Units must elect to separate the Units into the underlying Summit Public Shares and Summit Public Warrants prior to exercising redemption rights with respect to the Summit Public Shares. If holders hold their Units in an account at a brokerage firm or bank, holders must notify their broker or bank that they elect to separate the Units into the underlying Summit Public Shares and Summit Public Warrants, or if a holder holds Units registered in its own name, the holder must contact Continental, Summit’s transfer agent, directly and instruct it to do so. The redemption rights include the requirement that a holder must identify itself in writing as a beneficial holder and provide its legal name, phone number and address to Continental in order to validly redeem its Summit Public Shares.

If the Business Combination is not consummated, the Summit Public Shares will not be redeemed and instead will be returned to the respective holder, broker or bank. In such case, Summit Shareholders may only share in the assets of the trust account upon the liquidation of Summit. This may result in Summit Shareholders receiving less than they would have received if the Business Combination was completed and they had exercised redemption rights in connection therewith due to potential claims of creditors.

If a Summit Public Shareholder satisfies the requirements for exercising redemption rights with respect to all or a portion of the Summit Public Shares he, she or it holds and the Business Combination is consummated, Summit will redeem such Summit Public Shares for a per-share price, payable in cash, equal to the pro rata portion of the amount on deposit in the trust account calculated as of two business days prior to the consummation of the Business Combination, including interest earned on the funds held in the trust account and not previously released to Summit to pay income taxes (less up to \$100,000 of interest to pay dissolution expenses). There are currently no owed but unpaid income taxes on the funds in the trust account. However, the proceeds deposited in the trust account could become subject to the claims of Summit’s creditors, if any, which would have priority over the claims of Summit Shareholders. Therefore, the per share distribution from the trust account in such a situation may be less than originally expected due to such claims. It is expected that the funds to be distributed to Summit Public Shareholders electing to redeem their Summit Public Shares shall be distributed promptly after the consummation of the Business Combination.

Notwithstanding the foregoing, a Summit Public Shareholder, together with any affiliate of such holder and any person with whom such holder is acting in concert or as a “group” (as defined under Section 13(d)(3) of the Exchange Act), may not seek to have more than 15% of the aggregate Summit Public Shares redeemed without the prior consent of Summit. Additionally, under the Summit Articles, in no event will Summit redeem Summit Public Shares in an amount that would cause its net tangible assets to be less than \$5,000,001, such that Summit is not subject to the SEC’s “penny stock” rules.

Any request for redemption, once made by a Summit Public Shareholder, may be withdrawn at any time up to two business days prior to the vote at Extraordinary General Meeting. After this time, a request for redemption may not be withdrawn unless the Summit Board determines (in its sole discretion) to permit the withdrawal of such redemption request (which it may do in whole or in part). Such a request must be made by contacting Continental, Summit’s transfer agent, at the phone number or address set out elsewhere in this proxy statement/prospectus.

No request for redemption shall be honored unless the holder’s share certificates (if any) or shares have been delivered (either physically or electronically) to Continental, Summit’s transfer agent, in the manner described above, at least two business days prior to the vote at the Extraordinary General Meeting.

If you exercise your redemption rights, then you shall be exchanging your Summit Public Shares for cash and shall not be entitled to receive any YS Biopharma Ordinary Shares in respect of such redeemed shares upon consummation of the Business Combination.

If you are a holder of Summit Public Shares and you exercise your redemption rights, such exercise shall not result in the loss of any Summit Warrants that you may hold. Assuming 100% redemption, the Summit Warrants owned by such redeeming Summit Public Shareholders will be worth approximately \$2.8 million in the aggregate based on the closing price of Summit Warrants on the Record Date of \$0.2774.

The closing price of Summit Public Shares on the Record Date was \$10.12. The cash held in the trust account on such date was approximately \$202 million (approximately \$10.1 per Summit Public Share). Prior to exercising redemption rights, Summit Public Shareholders should verify the market price of Summit Public Shares as they may receive higher proceeds from the sale of their Summit Public Shares in the public market than from exercising their redemption rights if the market price per share is higher than the redemption price. Summit cannot assure its shareholders that they shall be able to sell their Summit Public Shares in the open market, even if the market price per share is higher than the redemption price stated above, as there may not be sufficient liquidity in its securities when its shareholders wish to sell their shares.

#### **Appraisal Rights under the Cayman Islands Companies Act**

Holders of record of Summit Shares may have appraisal rights in connection with the Business Combination under the Cayman Islands Companies Act. In this proxy statement/prospectus, these appraisal or dissent rights are sometimes referred to as “Dissent Rights.”

Holders of record of Summit Shares wishing to exercise such Dissent Rights and make a demand for payment of the fair market value for his, her or its Summit Shares must give written objection to the Mergers to Summit prior to the shareholder vote at the Extraordinary General Meeting to approve the Mergers and follow the procedures set out in Section 238 of the Cayman Islands Companies Act. These statutory appraisal rights are separate to and mutually exclusive of the right of Summit Public Shareholders to demand that their Summit Public Shares are redeemed for cash for a pro rata share of the funds on deposit in the trust account in accordance with the Summit Articles. It is possible that if a Summit shareholder exercises appraisal rights, the fair value of the Summit Shares determined under Section 238 of the Cayman Islands Companies Act could be more than, the same as, or less than such holder would obtain if they exercised their redemption rights as described herein. Summit believes that such fair market value would equal the amount that Summit Public Shareholders would obtain if they exercise their redemption rights as described herein.

Summit Shareholders need not vote against any of the proposals at the Extraordinary General Meeting in order to exercise Dissent Rights. A Summit shareholder which elects to exercise Dissent Rights must do so in respect of all of the Summit Shares that person holds and will lose their right to exercise their redemption rights as described herein.



At the First Merger Effective Time, the Dissenting Summit Shares shall automatically be cancelled by virtue of the First Merger, and each Dissenting Summit Shareholder will thereafter cease to have any rights with respect to such shares, except the right to be paid the fair value of such shares and such other rights as are granted by the Cayman Islands Companies Act. Notwithstanding the foregoing, if any such holder shall have failed to perfect or withdraws or shall have otherwise lost his, her or its rights under Section 238 of the Cayman Islands Companies Act (including in the circumstances described in the immediately following paragraph) or a court of competent jurisdiction shall determine that such holder is not entitled to the relief provided by Section 238 of the Cayman Islands Companies Act, then the right of such holder to be paid the fair value of such holder's Dissenting Summit Shares under Section 238 of the Cayman Islands Companies Act will cease, the shares will no longer be considered Dissenting Summit Shares and such holder's former Summit Shares will thereupon be deemed to have been converted into, and to have become exchangeable for, as of the First Merger Effective Time, the right to receive such fraction of a newly issued YS Biopharma Ordinary Share that is equal to the Class A Exchange Ratio (subject to rounding) for each Summit Share, without any interest thereon. As a result, such Summit shareholder would not receive any cash for their Summit Shares and would become a shareholder of YS Biopharma, which will be the public company following the consummation of the Business Combination.

The Business Combination Agreement provides that, if any Summit shareholder exercises Dissent Rights then, unless Summit and YS Biopharma elect by agreement in writing otherwise, the completion of the Mergers shall be delayed in order to invoke the exemption under Section 239 of the Cayman Islands Companies Act. Section 239 of the Cayman Islands Companies Act states that no such dissenter rights under section 238 of the Cayman Islands Companies Act shall be available in respect of shares of any class for which an open market exists on a recognized stock exchange or recognized interdealer quotation system at the expiry date of the period allowed for written notice of an election to dissent provided that the merger consideration constitutes *inter alia* shares of any company which at the effective date of the merger are either listed on a national securities exchange or designated as a national market system security on a recognized interdealer quotation system or held of record by more than two thousand holders. In circumstances where the limitation under Section 239 of the Cayman Islands Companies Act is invoked, no Dissent Rights would be available to Summit Shareholders, including those Summit Shareholders who previously delivered a written objection to the First Merger prior to the Extraordinary General Meeting and followed the procedures set out in Section 238 of the Cayman Islands Companies Act in full up to such date, and such holder's former Summit Shares will thereupon be deemed to have been converted into, and to have become exchangeable for, as of the First Merger Effective Time, the right to receive such fraction of a newly issued YS Biopharma Ordinary Share that is equal to the Class A Exchange Ratio (subject to rounding), for each Summit Share, without any interest thereon. Accordingly, Summit Shareholders are not expected to ultimately have any appraisal or dissent rights in respect of their Summit Shares and the certainty provided by the redemption process may be preferable for Summit Public Shareholders wishing to exchange their Summit Public Shares for cash.

#### **Proxy Solicitation Costs**

Summit is soliciting proxies on behalf of its board of directors. This solicitation is being made by mail but also may be made by telephone or in person. Summit and its directors, officer and employees may also solicit proxies in person by telephone or by other electronic means. Summit shall bear the cost of the solicitation.

Summit has hired Advantage to assist in the proxy solicitation process. Summit shall pay that firm a fixed fee of \$10,000, plus disbursements, and will reimburse Advantage for its reasonable out-of-pocket expenses and indemnify Advantage and its affiliates against certain claims, liabilities, losses, damages, and expenses. Such fee shall be paid with non-trust account funds. Summit shall pay the cost of soliciting proxies for the Extraordinary General Meeting.

Summit shall ask banks, brokers and other institutions, nominees and fiduciaries to forward the proxy materials to their principals and to obtain their authority to execute proxies and voting instructions, and shall reimburse such parties for their expenses in forwarding soliciting materials to beneficial owners of Summit Shares and in obtaining voting instructions from those owners.

Summit's directors and officer may also solicit proxies by telephone, by facsimile, by mail, on the Internet or in person. They will not be paid any additional amounts for soliciting proxies.

## THE BUSINESS COMBINATION AGREEMENT

### General

Holders of Summit Shares are being asked to adopt the Business Combination Agreement, approve the terms thereof and approve the Business Combination. Holders of Summit Shares should read carefully this proxy statement/prospectus in its entirety for more detailed information concerning the Business Combination Agreement, which is attached as **Annex A** to this proxy statement/prospectus. Please see the section entitled “— The Business Combination Agreement” below, for additional information and a summary of the material terms of the Business Combination Agreement. You are urged to read carefully the Business Combination Agreement in its entirety before voting on this proposal.

Summit may consummate the Business Combination only if the Business Combination Proposal is approved by an ordinary resolution, requiring the affirmative vote of the holders of a majority of the issued and outstanding Summit Shares present in person physically or by virtual attendance or represented by proxy and entitled to vote at the Extraordinary General Meeting, and the Merger Proposal is approved by a special resolution, requiring the affirmative vote of the holders of at least two-thirds of the issued and outstanding Summit Shares present in person physically or by virtual attendance or represented by proxy and entitled to vote at the Extraordinary General Meeting.

### The Business Combination Agreement

On September 29, 2022, Summit, Merger Sub I, Merger Sub II and YS Biopharma entered into the Business Combination Agreement. The subsections that follow this subsection describe the material provisions of the Business Combination Agreement, but do not purport to describe all of the terms of the Business Combination Agreement. The following summary is qualified in its entirety by reference to the complete text of the Business Combination Agreement, a copy of which is attached as **Annex A** hereto. Summit shareholders and other interested parties are urged to read the Business Combination Agreement carefully and in its entirety (and, if appropriate, with the advice of financial and legal counsel) because it is the primary legal document that governs the Business Combination.

Capitalized terms in this section not otherwise defined in this proxy statement/prospectus shall have the meanings ascribed to them in the Business Combination Agreement.

### *Transaction Structure*

The Business Combination Agreement provides for (i) the merger of Merger Sub I with and into Summit (the “First Merger”), with Summit surviving the First Merger as the surviving entity (the “Surviving Entity”) and becoming a wholly-owned subsidiary of YS Biopharma, and (ii) the merger of the Surviving Entity with and into Merger Sub II (the “Second Merger,” and together with the First Merger, the “Mergers,” together with other transactions contemplated by the Business Combination Agreement, the “Transactions”), with Merger Sub II surviving the Second Merger as the surviving company (the “Surviving Company”) and remaining as the wholly-owned subsidiary of YS Biopharma.

### *YS Biopharma Capital Restructuring*

On the Closing Date and immediately prior to the effective time of the First Merger (the “First Merger Effective Time”), (i) each YS Biopharma Preferred Share that is issued and outstanding immediately prior to the First Merger Effective Time shall be converted into YS Biopharma Ordinary Shares on a one-for-one basis in accordance with the Shareholders Agreement and in compliance with the YS Biopharma Articles; (ii) each YS Biopharma Ordinary Share (and for the avoidance of doubt, any warrant, right or other security convertible into or exchangeable or exercisable therefor other than YS Biopharma Options set forth in (iii) of this paragraph below) that is issued and outstanding immediately prior to the First Merger Effective Time shall be converted (or made exchangeable or exercisable) into a number of YS Biopharma Ordinary Shares determined by multiplying each such YS Biopharma Ordinary Share by 0.25 (together with the treatment of YS Biopharma Options set forth in (iii) of this paragraph below, the “Share Consolidation”); provided, that no fractional YS Biopharma Ordinary Shares will be issued by virtue of the Share Consolidation, and each YS Biopharma Shareholder that would otherwise be so entitled to a fraction of a YS Biopharma Ordinary Share

(after aggregating all fractional YS Biopharma Ordinary Shares that otherwise would be received by such YS Biopharma Shareholder) shall instead be entitled to receive such number of YS Biopharma Ordinary Shares to which such YS Biopharma Shareholder would otherwise be entitled, rounded up to the nearest whole YS Biopharma Ordinary Share; (iii) each YS Biopharma Option outstanding as of the effective time of the Share Consolidation (the “Share Consolidation Effective Time”) will, automatically and without any action on the part of any holder of such YS Biopharma Option or beneficiary thereof, continue to be an option to purchase YS Biopharma Ordinary Shares (each a “Continuing Option”) subject to substantially the same terms and conditions as were applicable to such YS Biopharma Option immediately before the Share Consolidation Effective Time (including expiration date and exercise provisions), except that: (A) each Continuing Option shall be exercisable for that number of YS Biopharma Ordinary Shares equal to the product (rounded up to the nearest whole YS Biopharma Ordinary Share) of the number of YS Biopharma Ordinary Shares subject to such YS Biopharma Option immediately before the Share Consolidation Effective Time multiplied by 0.25; and (B) the per share exercise price for each YS Biopharma Ordinary Share issuable upon exercise of the Continuing Option shall be equal to the quotient (rounded up to the nearest four decimal points) obtained by dividing the exercise price per YS Biopharma Ordinary Share of such YS Biopharma Option immediately before the Share Consolidation Effective Time by 0.25; provided, however, that the exercise price and the number of YS Biopharma Ordinary Shares purchasable under each Continuing Option shall, to the extent applicable, be determined in a manner consistent with the requirements of Section 409A of the Code and the applicable regulations promulgated thereunder. Items (i) through (iii) are collectively referred to as the “YS Biopharma Capital Restructuring.”

### ***The First Merger***

At the First Merger Effective Time, (i) Merger Sub I shall merge with and into Summit, following which the separate corporate existence of Merger Sub I shall cease and Summit shall continue as the Surviving Entity after the First Merger and become a direct, wholly-owned subsidiary of YS Biopharma; (ii) all the property, rights, privileges, agreements, powers and franchises, debts, liabilities, duties and obligations of Merger Sub I and Summit shall become the property, rights, privileges, agreements, powers and franchises, debts, liabilities, duties and obligations of the Surviving Entity, which shall include the assumption by the Surviving Entity of any and all agreements, covenants, duties and obligations of Merger Sub I and Summit set forth in the Business Combination Agreement to be performed after the First Merger Effective Time; (iii) the memorandum and articles of association of Merger Sub I, as in effect immediately prior to the First Merger Effective Time, shall be the memorandum and articles of association of the Surviving Entity; (iv) the directors and officers of Summit immediately prior to the First Merger Effective Time shall resign and the directors and officers of Merger Sub I immediately prior to the First Merger Effective Time shall be the directors and officers of the Surviving Entity, each to hold office in accordance with the organizational documents of the Surviving Entity; and (v) (a) Mr. Bo Tan (or in the event such person is unable or unwilling to serve as a director, another individual who was a director of Summit prior to the Closing designated by Summit in writing at least two Business Days before the First Merger Effective Time, subject to such person passing customary background checks by YS Biopharma) and (b) one additional director as nominated by YS Biopharma shall be appointed as directors on the board of directors of YS Biopharma, in addition to the then existing directors of YS Biopharma, effective as of the First Merger Effective Time, and each of such newly appointed directors shall hold office in accordance with the Amended YS Biopharma Articles until he is removed or resign in accordance with the Amended YS Biopharma Articles or until his successor is duly elected or appointed and qualified. Ms. Rui Lin and Mr. Zhi Chen shall resign as directors of YS Biopharma, effective immediately prior to the First Merger Effective Time.

Prior to the First Merger Effective Time, YS Biopharma will be renamed as YS Biopharma Co., Ltd.

### ***The Second Merger***

At the Second Merger Effective Time, (i) the Surviving Entity shall merge with and into Merger Sub II, following which the separate corporate existence of the Surviving Entity shall cease and Merger Sub II shall continue as the surviving entity (the “Surviving Company”) after the Second Merger and as a direct, wholly-owned subsidiary of YS Biopharma; (ii) all the property, rights, privileges, agreements, powers and franchises, debts, liabilities, duties and obligations of the Surviving Entity and Merger Sub II shall become the property, rights, privileges, agreements, powers and franchises, debts, liabilities, duties and obligations of the Surviving

Company, which shall include the assumption by the Surviving Company of any and all agreements, covenants, duties and obligations of the Surviving Entity and Merger Sub II set forth in the Business Combination Agreement to be performed after the Second Merger Effective Time; (iii) the memorandum and articles of association of Merger Sub II, as in effect immediately prior to the Second Merger Effective Time, shall be the memorandum and articles of association of the Surviving Company, until thereafter changed or amended as provided therein or by applicable law; and (iv) the directors and officers of Merger Sub II immediately prior to the Second Merger Effective Time shall be the directors and officers of the Surviving Company, each to hold office in accordance with the organizational documents of the Surviving Company.

#### ***Merger Consideration***

Subject to, and in accordance with the terms and subject to the conditions set forth in the Business Combination Agreement, following completion of the YS Biopharma Capital Restructuring and immediately prior to the First Merger Effective Time, (i) each Unit (each consisting of one Summit Class A Ordinary Share and one-half of one Summit Warrant included as part of a Unit) issued and outstanding immediately prior to the First Merger Effective Time shall be automatically detached and the holder thereof shall be deemed to hold one Summit Class A Ordinary Share and one-half of one Summit Warrant (the “Unit Separation”); (ii) each Summit Class A Ordinary Share (including Summit Class A Ordinary Shares held by Summit’s public shareholders as a result of the Unit Separation and Summit Class A Ordinary Shares to be issued pursuant to the Forward Purchase Subscriptions) issued and outstanding immediately prior to the First Merger Effective Time (other than any treasury Summit Shares, redeeming Summit Shares and dissenting Summit Shares) shall automatically be cancelled and cease to exist in exchange for the right to receive such fraction of newly issued YS Biopharma Ordinary Shares after the YS Biopharma Capital Restructuring that is equal to the Summit Class A Exchange Ratio, without interest; (iii) an aggregate of 1,446,525 Summit Class B Ordinary Shares held by the Sponsor will be surrendered for nil consideration, and after such surrender, each of the remaining Summit Class B Ordinary Shares held by Sponsor and the independent directors of Summit issued and outstanding immediately prior to the First Merger Effective Time shall automatically be cancelled and cease to exist in exchange for the right to receive one newly issued YS Biopharma Ordinary Share; (iv) each Summit Class B Ordinary Share held by a Forward Purchase Investor and its permitted transferees issued and outstanding immediately prior to the First Merger Effective Time shall automatically be cancelled and cease to exist in exchange for the right to receive (a) such fraction of newly issued YS Biopharma Ordinary Shares that is equal to the Summit Class A Exchange Ratio, without interest, if and only if such Forward Purchase Investor has fully delivered its portion of the Forward Purchase Investment Amount as required under the applicable Forward Purchase Agreement and, failing that, (b) one newly issued YS Biopharma Ordinary Share; and (v) each whole Summit Warrant outstanding immediately prior to the First Merger Effective Time shall cease to be a warrant with respect to Summit Shares and be assumed by YS Biopharma and converted into a warrant to purchase one YS Biopharma Ordinary Share, subject to substantially the same terms and conditions prior to the First Merger Effective Time. No fractional shares or warrants will be issued in the foregoing process, and all such shares or warrants would be rounded down to the nearest whole number of shares or warrants.

In addition, upon the consummation of the First Merger, (i) if there are any Summit Shares that are owned by Summit as treasury shares or any Summit Shares owned by any direct or indirect subsidiary of Summit immediately prior to the First Merger Effective Time, such Summit Shares shall be canceled and shall cease to exist without any conversion thereof or payment or other consideration therefor; (ii) each Redeeming Summit Share issued and outstanding immediately prior to the First Merger Effective Time shall be cancelled and cease to exist and shall thereafter represent only the right to be paid a pro rata share of the Summit Shareholder Redemption Amount in accordance with Summit’s amended and restated memorandum and articles of association; and (iii) each Dissenting Summit Share issued and outstanding immediately prior to the First Merger Effective Time held by a Dissenting Summit Shareholder shall be cancelled and cease to exist and shall thereafter represent only the right to be paid the fair value of such Dissenting Summit Share and such other rights as are granted by the Cayman Islands Companies Act.

#### ***Representations and Warranties***

The Business Combination Agreement contains representations and warranties made by YS Biopharma to Summit relating to a number of matters, including, among other things, corporate organization, qualification

to do business, good standing and corporate power, requisite corporate authority to enter into the Business Combination Agreement and to complete the contemplated transactions, absence of conflicts, required governmental and regulatory consents, capitalization of YS Biopharma and its subsidiaries and financial statements.

The Business Combination Agreement also contains representations and warranties made by Summit to YS Biopharma relating to a number of matters, including, among other things, corporate organization, qualification to do business, good standing and corporate power, requisite corporate authority to enter into the Business Combination Agreement and to complete the contemplated transactions, absence of conflicts, required governmental and regulatory consents, the Nasdaq quotation, and proxy statement/prospectus.

This summary and the copy of the Business Combination Agreement attached to this proxy statement/prospectus as Annex A are included solely to provide investors with information regarding certain terms of the Business Combination Agreement. They are not intended to provide factual information about the parties or any of their respective subsidiaries or affiliates. The Business Combination Agreement contains representations and warranties by YS Biopharma, Summit, Merger Sub I and Merger Sub II, which were made only for purposes of that agreement and as of specific dates set forth therein and solely for the benefit of the parties to the Business Combination Agreement. These representations and warranties may be subject to limitations agreed upon by the contracting parties and may be subject to standards of materiality applicable to the contracting parties that differ from those generally applicable to investors. Investors are not third-party beneficiaries of the representations and warranties made in the Business Combination Agreement.

### **Covenants**

#### *Covenants of YS Biopharma*

YS Biopharma made certain covenants under the Business Combination Agreement (subject to the terms and conditions set forth therein), including, among other things, the following:

- From the date of the Business Combination Agreement through the earlier of the Closing or valid termination of the Business Combination Agreement (the “Interim Period”), subject to certain exceptions, YS Biopharma (i) shall use commercially reasonable efforts to operate the business of YS Biopharma and its subsidiaries in the ordinary course, (ii) shall use commercially reasonable efforts to preserve YS Biopharma and its subsidiaries’ business and operational relationships in all material respects with the suppliers, customers and others having business relationships with YS Biopharma and its subsidiaries that are material to YS Biopharma and its subsidiaries, taken as a whole, in each case where commercially reasonable to do so, and (iii) shall not, and shall cause its subsidiaries not to, except as otherwise expressly required or permitted by the Business Combination Agreement or the other transaction documents or required by law, to:
  - amend its memorandum and articles of association or other organizational documents (whether by merger, consolidation, amalgamation or otherwise), subject to certain exceptions;
  - liquidate, dissolve, reorganize or otherwise wind-up its business and operations, or propose or adopt a plan of complete or partial liquidation or dissolution, restructuring, recapitalization, reclassification or similar change in capitalization or other reorganization (other than liquidation or dissolution of any dormant subsidiary);
  - except in the ordinary course, incur, assume, guarantee or repurchase or otherwise become liable for any indebtedness, or issue or sell any debt securities or options, warrants or other rights to acquire debt securities, in any such case in a principal amount exceeding \$1,000,000, subject to certain exceptions;
  - transfer, issue, sell, grant, pledge or otherwise dispose of (i) any capital stock, equity interests, membership interests, partnership interests or registered capital, joint venture or other ownership interests of YS Biopharma or any of its subsidiaries to a third party, or (ii) any options, warrants or other securities that are directly or indirectly convertible into, or exercisable or exchangeable for, or any other rights, agreements, arrangements, or commitment obligations of YS Biopharma or any of its subsidiaries to purchase or obtain any capital stock, equity interests, membership interests, partnership interests or registered capital, joint venture or other ownership interests of YS Biopharma or any of its subsidiaries to a third party, subject to certain exceptions;

- sell, lease, sublease, license, transfer, abandon, allow to lapse or dispose of any material property or assets (other than intellectual property), in any single transaction or series of related transactions, subject to certain exceptions;
- sell, assign, transfer, lease, license or sublicense, abandon, permit to lapse or otherwise dispose of or impose any encumbrance upon any material Owned IP (as defined in the Business Combination Agreement), in each case, except for non-exclusive licenses or non-material exclusive licenses under material owned intellectual property granted in the ordinary course, subject to certain exceptions;
- disclose any trade secrets or material confidential information;
- make any acquisition of, or investment in, a business, by purchase of stock, securities or assets, merger or consolidation, or contributions to capital, or loans or advances, in any such case with a value or purchase price in excess of \$1,000,000 individually and \$2,000,000 in the aggregate;
- settle any charge, claim, action, complaint, petition, investigation, appeal, suit, litigation or other similar proceeding by any governmental authority or any other third-party material to the business of YS Biopharma and its subsidiaries taken as a whole, in excess of \$1,000,000 individually and \$2,000,000 in the aggregate;
- split, combine, subdivide, reclassify, or amend any terms of its share capital, subject to certain exceptions;
- redeem, repurchase, cancel or otherwise acquire or offer to redeem, repurchase, or otherwise acquire any of its equity securities, except for the redemption of equity securities issued under the ESOP or as disclosed in the Company Disclosure Letter (as defined in the Business Combination Agreement);
- declare, set aside, make or pay any dividend or other distribution, payable in cash, shares, property or otherwise, with respect to any of its share capital other than dividends or distributions by any subsidiary of YS Biopharma on a pro rata basis to its shareholders;
- amend any term or alter any rights of any of its outstanding equity securities;
- except in the ordinary course, authorize, make or incur any capital expenditures or obligations or liabilities in connection therewith, other than any capital expenditures or obligations or liabilities in an amount not to exceed \$2,000,000 in the aggregate;
- except in the ordinary course, accelerate or delay in any respect material to YS Biopharma and its subsidiaries, taken as a whole (A) collection of any account receivable in advance of or beyond its due date, or (B) payment of any account payable in advance of or beyond its due date;
- except in the ordinary course or as disclosed in the Company Disclosure Letter (as defined in the Business Combination Agreement), enter into any material contract, or amend any such material contract or extend, transfer, terminate or waive any right or entitlement of material value under any material contract, in a manner that is adverse to YS Biopharma and its subsidiaries, taken as a whole, other than in any immaterial respect;
- voluntarily terminate (other than expiration in accordance with its terms), suspend, abrogate, amend or modify any material permit except in the ordinary course or as would not be material to the business of YS Biopharma and its subsidiaries, taken as a whole;
- make any material change in its accounting principles or methods unless required by U.S. GAAP or applicable laws;
- except in the ordinary course, (i) make, change or revoke any election in respect of material taxes, (ii) adopt or change any material tax accounting method, (iii) file any material amended tax return, (iv) enter into any material tax closing agreement with any governmental authority, (v) settle any income or material tax claim or assessment, (vi) surrender any right to claim a refund of material taxes, (vii) consent to any extension or waiver of the limitation period applicable to or relating to any material tax claim or assessment, or (viii) knowingly fail to pay any material tax that becomes due and payable (including estimated tax payments) (other than taxes being contested in good faith and for which adequate reserves have been established in the financial statements of YS Biopharma in accordance with U.S. GAAP);

- increase the compensation or benefits payable or provided, or to become payable or provided to, any key officer or any current or former directors, officers or individual service providers of YS Biopharma or any of its subsidiaries whose total annual compensation opportunity exceeds \$200,000, subject to certain exceptions;
- during the Interim Period, YS Biopharma shall not and shall cause its controlled affiliates and its and their respective representatives not to, directly or indirectly (a) solicit, initiate, submit facilitate, discuss or negotiate any inquiry, proposal or offer (written or oral) with any third party with respect to a Company Acquisition Proposal (as defined in the Business Combination Agreement), (b) furnish or disclose any non-public information to any third party in connection with or that would reasonably be expected to lead to a YS Biopharma acquisition proposal, (c) enter into any agreement, arrangement or understanding with any third party regarding a YS Biopharma acquisition proposal, (d) prepare or take any steps in connection with a public offering of any equity securities of YS Biopharma, any of its subsidiaries, or a newly-formed holding company of YS Biopharma or such subsidiaries, or (e) otherwise cooperate in any way with, or assist or participate in, or knowingly facilitate or encourage any effort or attempt by any person to do or seek to do any of the foregoing.
- during the Interim Period, YS Biopharma shall use reasonable efforts to keep current and accurately and timely file all reports required to be filed or furnished with the SEC and otherwise comply in all material respects with its reporting obligations under applicable laws.

Subject to the terms and conditions of the Amended YS Biopharma Article, YS Biopharma shall take all such action within its power as may be necessary or appropriate such that immediately following the Closing:

- the board of directors of YS Biopharma (i) shall have been reconstituted to consist of no less than seven (7) directors, of which (A) the majority shall be such persons as YS Biopharma may designate sufficiently in advance to allow for inclusion of such persons in the proxy statement/prospectus and (B) the Sponsor may designate no more than two persons pursuant to a written notice to be delivered to YS Biopharma sufficiently in advance to allow for inclusion of such persons in the proxy statement/prospectus and (ii) shall have reconstituted its applicable committees to consist of the directors designated by YS Biopharma prior to the Closing Date; provided, however, that the directors designated by YS Biopharma in accordance with clause (ii) of this sentence shall satisfy the independence requirements and other qualifications for the applicable committees as required by applicable laws or under the Nasdaq listing rules;
- the chairperson of the board of directors of YS Biopharma shall initially be Mr. Yi Zhang; and
- the officers of YS Biopharma holding such positions as set forth on a schedule to the Business Combination Agreement shall be the officers of YS Biopharma, each such officer to hold office in accordance with the Amended YS Biopharma Articles until they are removed or resign in accordance with the Amended YS Biopharma Articles or until their respective successors are duly elected or appointed and qualified.

#### *Covenants of Summit and the Merger Subs*

Summit, Merger Sub I and Merger Sub II (the “Merger Subs”, and each, a “Merger Sub”) made certain covenants under the Business Combination Agreement (subject to the terms and conditions set forth therein), including, among other things, the following:

- during the Interim Period, Summit shall use reasonable best efforts to ensure Summit remains listed as a public company on Nasdaq and to continue the listing of the Summit Class A Ordinary Shares, the Summit Warrants and the Units on the Nasdaq;
- during the Interim Period, subject to certain exceptions, Summit and the Merger Subs shall operate its respective business in the ordinary course and shall not:
  - with respect to Summit only, seek any approval from Summit shareholders to change, modify or amend the Trust Agreement or the Summit Articles, except as contemplated by the Business Combination Proposal and the Merger Proposal;
  - declare, set aside, establish a record date for, make or pay any dividend or other distribution, payable in cash, shares, property or otherwise, with respect to any of its share capital;
  - split, combine, subdivide, reclassify or otherwise amend any terms of its equity securities;

- redeem, repurchase, cancel or otherwise acquire or offer to redeem, repurchase, or otherwise acquire any of its equity securities, other than a redemption of Summit Class A Ordinary Shares in connection with the exercise of any Summit shareholder redemption right by any Summit shareholder or upon conversion of any Summit Class B Ordinary Shares in accordance with the Summit Articles;
- merge, consolidate or amalgamate with or into, or acquire (by purchasing a substantial portion of the assets of or equity in, or by any other manner) or make any advance or loan to or investment in any other person or be acquired by any other person;
- (i) make, change or revoke any election in respect of taxes, (ii) adopt or change any material tax accounting method, (iii) file any material amended tax return, (iv) enter into any material tax closing agreement with any governmental authority, (v) settle any material tax claim or assessment, (vi) surrender any right to claim a refund of material taxes, (vii) consent to any extension or waiver of the limitation period applicable to or relating to any material tax claim or assessment, or (viii) knowingly fail to pay any material tax that becomes due and payable (including estimated tax payments) (other than taxes being contested in good faith and for which adequate reserves have been established in the financial statements of Summit in accordance with U.S. GAAP);
- enter into, renew or amend in any material respect, any transaction or material contract, subject to certain exceptions;
- enter into any material contract, and extend, transfer, terminate or waive any right or entitlement of material value under any material contract, in a manner that is materially adverse to Summit, subject to certain exceptions;
- incur, assume, guarantee or repurchase or otherwise become liable for any indebtedness, or issue or sell any debt securities or options, warrants, rights or conversion or other rights to acquire debt securities, or other material liability, or make any capital expenditures, in any case in a principal amount or amount, as applicable, exceeding \$1,000,000 individually or in the aggregate, subject to certain exceptions;
- make any change in its accounting principles or methods unless required by U.S. GAAP or applicable laws;
- issue any equity securities, other than the issuance of equity securities of Summit pursuant to the Forward Purchase Agreements or the Business Combination Agreement or the issuance of Summit Class A Ordinary Shares upon conversion of Summit Class B Ordinary Shares in accordance with the Summit Articles;
- settle or agree to settle any litigation, action, proceeding or investigation before any governmental authority or that imposes injunctive or other non-monetary relief on Summit or any Merger Sub;
- form any subsidiary;
- liquidate, dissolve, reorganize or otherwise wind-up the business and operations of Summit or propose or adopt a plan of complete or partial liquidation or dissolution, consolidation, restructuring, recapitalization, reclassification or similar change in capitalization or other reorganization of Summit; or
- enter into any agreement or otherwise make any commitment to do any action prohibited under any of the foregoing.

During the Interim Period, Summit shall not and shall cause its affiliates and its and their respective representatives not to directly or indirectly (a) solicit, initiate, submit, facilitate, discuss or negotiate any inquiry, proposal or offer (written or oral) with respect to a Summit acquisition proposal, (b) furnish or disclose any non-public information to any person or entity in connection with or that could reasonably be expected to lead to a Summit acquisition proposal, (c) enter into any agreement, arrangement or understanding regarding a Summit acquisition proposal, or (d) otherwise cooperate in any way with, or assist or participate in, or knowingly facilitate or encourage any effort or attempt by any person to do or seek to do any of the foregoing.

During the Interim Period, Summit shall use reasonable efforts to keep current and accurately and timely file all reports required to be filed or furnished with the SEC and otherwise comply in all material respects with its reporting obligations under applicable laws.

#### *Joint Covenants*

The Business Combination Agreement also contains certain other covenants and agreements among the various parties, including, among other things, that each of YS Biopharma, Summit and the Merger Subs shall use commercially reasonable efforts to, subject to the terms and conditions contained therein:



- cooperate in good faith with any governmental authority and to undertake promptly any and all action required to obtain any necessary or advisable regulatory approvals, consents, actions, nonactions or waivers in connection with the Business Combination as soon as practicable and any and all action necessary to consummate the Business Combination, and to use commercially reasonable efforts to cause the expiration or termination of the waiting, notice or review periods under any applicable regulatory approval with respect to the Business Combination as promptly as possible after the execution of the Business Combination Agreement;
- diligently and expeditiously defend and use commercially reasonable efforts to obtain any necessary clearance, approval, consent or regulatory approval under any applicable laws prescribed or enforceable by any governmental authority for the Business Combination and to resolve any objections as may be asserted by any governmental authority with respect to the Business Combination, and cooperate fully with each other in the defense of such matters; and
- use commercially reasonable efforts to obtain all material consents and approvals of third parties that YS Biopharma and any of its subsidiaries or any of Summit and the Merger Subs, as applicable, are required to obtain in order to consummate the Business Combination.

Further, the Business Combination Agreement also contains additional covenants and agreements among the parties thereto in respect of, among other matters:

- access to information, properties and personnel;
- preparing, filing and distributing this proxy statement/prospectus on Form F-4 (including any amendments or supplements thereto);
- preparing and delivering certain accounts and financial statements;
- tax matters;
- shareholder litigation matters with respect to the Business Combination;
- indemnification of present and former directors and officers of YS Biopharma or any of its subsidiaries, Summit and the Merger Subs;
- written notice (i) of the occurrence or non-occurrence of any event the occurrence or non-occurrence of which has caused or is reasonably likely to cause any condition to the obligations of any party to effect the Business Combination not to be satisfied or (ii) of any notice or other communication from any governmental authority which is reasonably likely to have a material adverse effect on the ability of the parties to the Business Combination Agreement to consummate the Business Combination or to materially delay the timing thereof; or
- maintaining in effect liability insurances covering those persons who are currently covered by directors' and officers' liability insurance policies of YS Biopharma or any of its subsidiaries, Summit and the Merger Subs.

***Conditions Precedent to Consummate the Business Combination***

The Closing is subject to the satisfaction or waiver of certain customary conditions by the parties thereto, including, among other things, (i) approval of the Business Combination by the shareholders of Summit, YS Biopharma; (ii) effectiveness of the proxy statement/prospectus; (iii) approval of the Business Combination by YS Biopharma's Majority Lenders (as defined in the Business Combination Agreement); (iv) receipt of approval for listing on the Nasdaq of YS Biopharma Ordinary Shares and YS Biopharma Warrants; (v) Summit having at least \$5,000,001 of net tangible assets after deducting the Summit Shareholder Redemption Amount; and (vi) absence of any law (whether temporary, preliminary or permanent) or governmental order enacted, issued, promulgated, enforced or entered by governmental authority that is then in effect and which has the effect of making the Closing illegal or which otherwise prevents or prohibits consummation of the Closing, other than any such restraint that is immaterial.

The obligations of Summit to consummate the Business Combination are conditioned upon, among other things, (i) the accuracy of the representations and warranties of YS Biopharma and the Merger Subs (subject to customary bring-down standards and materiality qualifiers); (ii) the obligations and covenants of YS

Biopharma and the Merger Subs having been performed in all material respects; (iii) the Company Capital Restructuring (as defined in the Business Combination Agreement) shall have been completed and (iv) no material adverse effect with respect to YS Biopharma shall have occurred and is continuing.

The obligations of YS Biopharma and the Merger Subs to consummate the Business Combination are conditioned upon, among other things, (i) the accuracy of the representations and warranties of Summit (subject to customary bring-down standards and materiality qualifiers); (ii) the obligations and covenants of Summit having been performed in all material respects; (iii) the Available Closing Cash Amount (as defined in the Business Combination Agreement) is not less than \$30,000,000; and (iv) no material adverse effect with respect to Summit shall have occurred and is continuing.

### ***Termination***

The Business Combination Agreement may be terminated at any time prior to the Closing,

- by mutual written consent of YS Biopharma and Summit;
- by written notice from YS Biopharma or Summit to the other if any governmental authority shall have enacted, issued, promulgated, enforced or entered any governmental order which has become final and non-appealable and has the effect of permanently making consummation of the Business Combination illegal or otherwise preventing or prohibiting consummation of the Business Combination;
- by written notice from YS Biopharma to Summit if the Summit Board or any committee thereof has withheld, withdrawn, qualified, amended or modified, or publicly proposed or resolved to withhold, withdraw, qualify, amend or modify, the recommendation of Summit Board that the Summit shareholders vote in favor of the Business Combination Proposal;
- by written notice from YS Biopharma to Summit if the Summit shareholders' approval shall not have been obtained by reason of the failure to obtain the required vote at the Extraordinary General Meeting duly convened therefor or at any adjournment or postponement thereof;
- by written notice from Summit to YS Biopharma if the Summit shareholders' approval shall not have been obtained by reason of the failure to obtain the required vote at the Extraordinary General Meeting duly convened therefor or at any adjournment or postponement thereof, unless Summit has materially breached any of its obligations with respect to obtaining Summit shareholders' approval under the Business Combination Agreement;
- by written notice from Summit to YS Biopharma if there is any breach of any representation, warranty, covenant or agreement on the part of YS Biopharma or a Merger Sub set forth in the Business Combination Agreement, such that the conditions to Summit's obligations to consummate the Business Combination would not be satisfied at the Closing, and such breach cannot be or has not been cured within 30 days following receipt by YS Biopharma of notice from Summit of such breach, provided that Summit shall not have the right to terminate the Business Combination Agreement pursuant to this paragraph if it is then in material breach of any of its representations, warranties, covenants or agreements set forth in the Business Combination Agreement;
- by written notice from YS Biopharma to Summit if there is any breach of any representation, warranty, covenant or agreement on the part of Summit set forth in the Business Combination Agreement, such that the conditions to YS Biopharma and Merger Subs' obligation to consummate the Business Combination would not be satisfied at the Closing, and such breach cannot be or has not been cured within 30 days following receipt by Summit of notice from YS Biopharma of such breach, provided that YS Biopharma shall not have the right to terminate the Business Combination Agreement pursuant to this paragraph if it is then in material breach of any of its representations, warranties, covenants or agreements set forth in the Business Combination Agreement;
- by written notice from Summit to YS Biopharma if any YS Biopharma shareholder rescinds, revokes, withholds, withdraws, qualifies, amends or modifies YS Biopharma shareholders' approval, provided that Summit shall not have the right to terminate the Business Combination Agreement pursuant to this paragraph if such rescission, revocation, withholding, withdrawal, qualification, amendment or modification of YS Biopharma Shareholders' Approval results from a material amendment to the Transaction Documents (as defined in the Business Combination Agreement);

- by written notice from Summit to YS Biopharma if any director or shareholder of Merger Sub I or Merger Sub II rescinds, revokes, withholds, withdraws, qualifies, amends or modifies the Merger Sub I written resolutions or Merger Sub II written resolutions approving the Business Combination Agreement, the Plan of First Merger, the Plan of Second Merger and the Business Combination;
- by written notice from Summit or YS Biopharma to the other, if the transactions contemplated by the Business Combination Agreement shall not have been consummated on or prior to 270th day after the date of Business Combination Agreement; provided that the right to terminate the Business Combination Agreement pursuant to this paragraph will not be available to any party whose breach of any provision of the Business Combination Agreement primarily caused or resulted in the failure of the transactions to be consummated by such time; or
- by written notice from YS Biopharma to Summit if the condition set forth in section 9.3(c) of the Business Combination Agreement (i.e., the Available Closing Cash Amount (as defined in the Business Combination Agreement) is not less than \$30,000,000) becomes incapable of being satisfied at the Closing without any amendments, modifications or supplements to, or waivers under, the Business Combination Agreement.

In the event of termination of the Business Combination Agreement, the Business Combination Agreement shall become void and have no effect, without any liability on the part of any party thereto or its respective affiliates, officers, directors or shareholders, other than liability of YS Biopharma, Summit or the Merger Subs, as the case may be, for actual fraud or for any willful and material breach of the Business Combination Agreement occurring prior to such termination; provided that obligations under the NDA (as defined in the Business Combination Agreement) and certain obligations related to the trust account and certain other provisions required under the Business Combination Agreement shall, in each case, survive any termination of the Business Combination Agreement.

## AGREEMENTS ENTERED INTO IN CONNECTION WITH THE BUSINESS COMBINATION

This section describes the material provisions of certain additional agreements entered into or to be entered into pursuant to the Business Combination Agreement (the “Related Agreements”) but does not purport to describe all of the terms thereof. The following summary is qualified in its entirety by reference to the complete text of each of the Related Agreements, and you are urged to read such Related Agreements in their entirety.

### *Shareholder Support Agreement*

Concurrently with the execution of the Business Combination Agreement, YS Biopharma and Summit entered into a Shareholder Support Agreement and Deed (the “Shareholder Support Agreement”) with certain YS Biopharma shareholders (the “YSB Shareholders”) and certain Summit shareholders (the “SPAC Shareholders”) and together with the YSB Shareholders, the “Supporting Shareholders”) with respect to the shares of YS Biopharma and Summit currently owned by the Supporting Shareholders. The Shareholder Support Agreement provides that, among other things,

*Shareholder Support.* (i) the Supporting Shareholders will appear at shareholders meetings of YS Biopharma (or Summit, as applicable) and vote in favor of, consent to or approve the Business Combination Agreement and the transactions contemplated by the Business Combination Agreement, whether at a shareholder meeting of YS Biopharma (or Summit, as applicable) or by written consent, except that no YSB Shareholder shall be obliged to vote in favor of any future amendment, modification or supplement to the Business Combination Agreement or any other Transaction Documents, (ii) the Supporting Shareholders will vote against (or act by written consent against) any alternative proposals or actions that would impede, interfere with, delay, postpone or adversely affect the transactions contemplated by the Business Combination Agreement, (iii) the YSB Shareholders agree not to exercise any redemption rights with respect to the shares of YS Biopharma owned by them from the date of the Business Combination Agreement until the Shareholder Support Agreement is terminated in accordance with its terms, subject to certain exceptions set forth therein, (iv) the Sponsor agrees to reimburse Summit or YS Biopharma, at the Closing, certain transaction and operating expenses of Summit if such expenses exceed the amounts agreed by Summit and YS Biopharma, and (v) the Sponsor will surrender 1,446,525 Summit Class B Ordinary Shares for nil consideration immediately prior to the First Merger Effective Time and exchange all of the remaining Summit Shares held by it into YS Biopharma Ordinary Shares on a one-for-one basis at the First Merger Effective Time.

*Shareholders Rights.* (i) the letter agreement between Summit, Sponsor and certain other parties thereto, dated as of June 8, 2021, and all the registration and shareholder rights thereunder, will be terminated effective at the First Merger Effective Time; and (ii) YS Biopharma and the YSB Shareholders agree to amend the shareholders agreement of YS Biopharma (the “YS Biopharma Shareholders Agreement”) and terminate all the special shareholder rights and obligations thereunder, effective at the First Merger Effective Time, except for the following rights and transfer restrictions:

- (a) *Registration Rights.* The Supporting Shareholders, together with any other shareholder of YS Biopharma who currently is or subsequently becomes a party to the YS Biopharma Shareholders Agreement, are entitled to customary demand and piggyback registration rights. YS Biopharma also agrees to file a registration statement on Form F-1 within 20 days after the Closing (or 60 days if additional financial information is required) to register the registrable securities pursuant to the YS Biopharma Shareholders Agreement.
- (b) *Lock-Up Restrictions.* Summit and YS Biopharma agree to cause the Sponsor and the independent directors of Summit (together with the Sponsor, the “SPAC Insiders”) and all pre-Closing shareholders of YS Biopharma (together with the SPAC Insiders, the “YS Biopharma Lock-Up Shareholders”) to be subject to certain lock-up restrictions as provided therein, effective as of the First Merger Effective Time, pursuant to which, any YS Biopharma Ordinary Shares held by such YS Biopharma Lock-Up Shareholder immediately after the First Merger Effective Time (such YS Biopharma Ordinary Shares, collectively, the “YS Biopharma Lock-Up Shares”) shall not be transferred during the applicable lock-up period, subject to customary exceptions. For each YS Biopharma Lock-Up Shareholder who is not a SPAC Insider, the applicable lock-up period will be 180 days from and after the First Merger Effective Time. For each YS Biopharma Lock-Up Shareholder who is a SPAC Insider, the applicable lock-up period will be twelve months from and after the First Merger Effective Time. The lock-up requirements

will cease to apply after the date on which the closing price of the YS Biopharma Ordinary Shares equals or exceeds \$12.00 per share for any 20 trading days within any 30 trading day period commencing at least 150 days after the First Merger Effective Time. YS Biopharma may release, (i) in its sole discretion, up to 3,000,000 YS Biopharma Lock-Up Shares and (ii) with prior written consent from Summit and the Sponsor, an additional number of YS Biopharma Lock-Up Shares to the extent necessary to satisfy the minimum public float requirement as required for obtaining Nasdaq’s listing approval, provided that a release pursuant to sub-clauses (i) and (ii) shall apply on a pro rata basis to all YS Biopharma Lock-Up Shares held by YS Biopharma Lock-Up Shareholders who are holders of preferred shares of YS Biopharma (and ordinary shares issued upon conversion thereof) immediately prior to the First Merger Effective Time.

- (c) *Director Appointment Rights.* The Sponsor will have the right to appoint two directors on the board of directors of YS Biopharma so long as the Sponsor beneficially owns not less than 1% of all the issued and outstanding shares of YS Biopharma after the Closing.

***Warrant Assignment Agreement***

Concurrently with the execution of the Business Combination Agreement, YS Biopharma, Summit and Continental Stock Transfer & Trust Company, the warrant agent to Summit (the “Warrant Agent”), entered into a warrant assignment agreement (the “Warrant Assignment Agreement”) to amend such warrant agreement (the “Warrant Agreement”), dated June 8, 2021, by and between Summit and the Warrant Agent, pursuant to which Summit assigns and delegates to YS Biopharma all of its rights, interests, and obligations in and under the Warrant Agreement, effective as of the First Merger Effective Time.

***Forward Purchase Agreements***

Prior to the IPO, Summit entered into forward purchase agreements (collectively, the “Forward Purchase Agreements”) with each of Snow Lake Capital (HK) Limited and the Valliance Fund (collectively, the “Forward Purchase Investors”). The Forward Purchase Agreements provide for (i) the transfer of an aggregate of 375,000 Founder Shares from the Sponsor to the Forward Purchase Investors for nil cash consideration prior to the IPO and (ii) the purchase by the Forward Purchase Investors of an aggregate of 3,000,000 Summit Class A Ordinary Shares, plus an aggregate of 750,000 redeemable warrants to purchase Summit Class A Ordinary Shares at \$11.50 per share, for an aggregate purchase price of \$30,000,000 in a private placement to close concurrently with the closing of Summit’s initial business combination, which will be the consummation of the Transactions. The Forward Purchase Investors’ subscription obligations under the Forward Purchase Agreements do not depend on whether any Summit Class A Ordinary Shares are redeemed by Summit’s public shareholders. Proceeds received from the Forward Purchase Investors under the Forward Purchase Agreements will count towards the Available Closing Cash Amount, which is required to be not less than \$30,000,000 under the Business Combination Agreement. The Forward Purchase Investors have also agreed to vote all Summit Shares held by them in favor of Summit’s initial business combination if Summit seeks shareholder approval of such transaction.

**PROPOSAL NO. 1 — THE BUSINESS COMBINATION PROPOSAL****General**

Holders of Summit Shares are being asked to adopt the Business Combination Agreement, approve the terms thereof and approve the Business Combination. Holders of Summit Shares should read carefully this proxy statement/prospectus in its entirety for more detailed information concerning the Business Combination Agreement, which is attached as **Annex A** to this proxy statement/prospectus. For additional information and a summary of the material terms of the Business Combination Agreement, see sections entitled “— The Business Combination Agreement” below and “The Business Combination Agreement.” You are urged to read carefully the Business Combination Agreement in its entirety before voting on this Proposal.

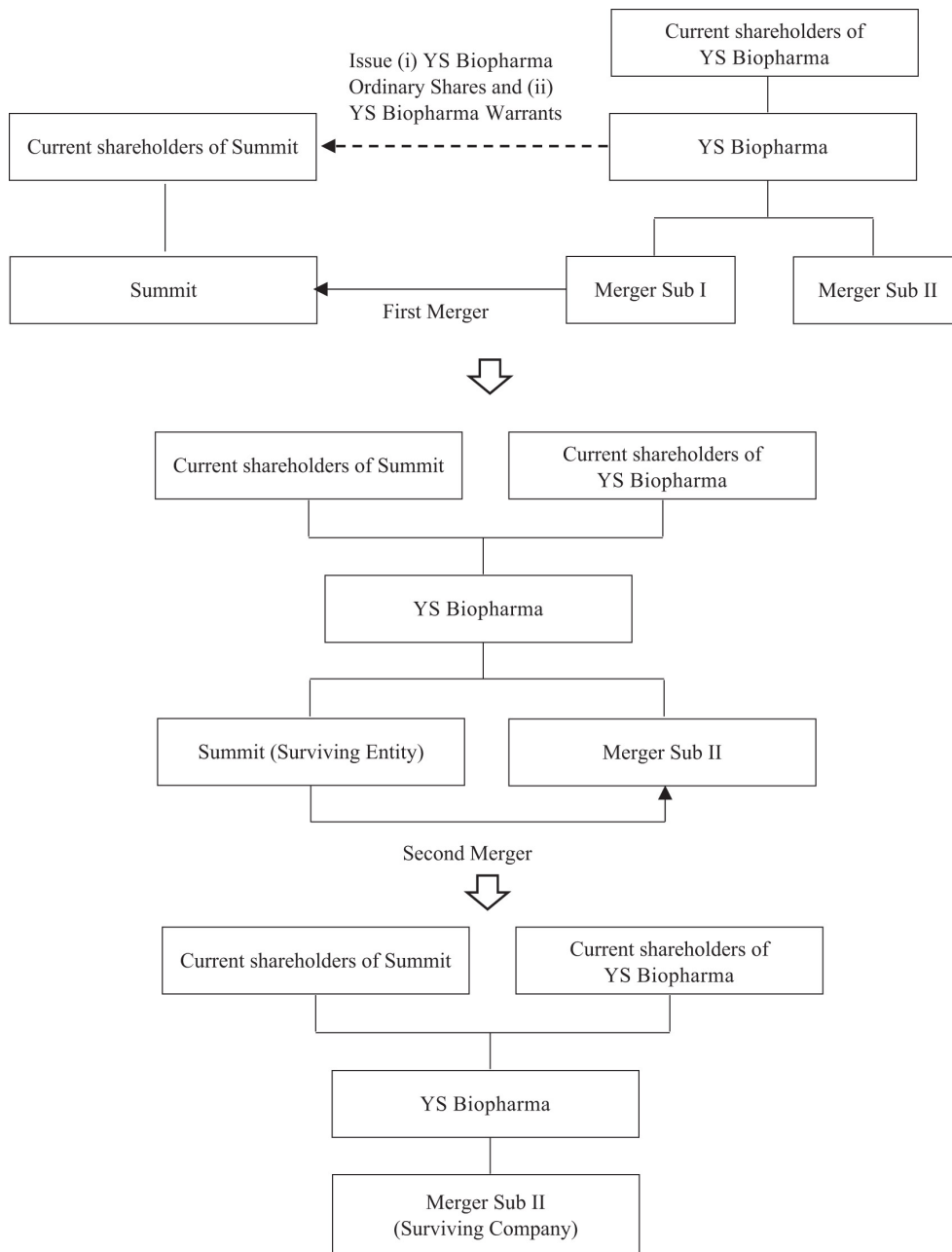
Summit may consummate the Business Combination only if the Business Combination Proposal is approved by an ordinary resolution, requiring the affirmative vote of the holders of a majority of the issued and outstanding Summit Shares present in person physically or by virtual attendance or represented by proxy and entitled to vote at the Extraordinary General Meeting, and the Merger Proposal is approved by a special resolution, requiring the affirmative vote of the holders of at least two-thirds of the issued and outstanding Summit Shares present in person physically or by virtual attendance or represented by proxy and entitled to vote at the Extraordinary General Meeting.

**The Business Combination Agreement**

Please see sections entitled “The Business Combination Agreement” and “Agreements Entered Into in Connection with the Business Combination” for additional information and a summary of certain terms of the Business Combination Agreement and the Related Agreements. You are urged to read carefully the Business Combination Agreement in its entirety before voting on this Proposal.

**Organizational Structure**

The following diagrams illustrate in simplified terms the current structure of each of Summit and YS Biopharma, the steps of the proposed Business Combination, and the expected structure after the Business Combination.



**Resale of YS Biopharma Ordinary Shares**

The YS Biopharma Ordinary Shares to be issued to shareholders of Summit in connection with the Business Combination will be freely transferable under the Securities Act except for shares issued to any shareholder who may be deemed for purposes of Rule 144 under the Securities Act an “affiliate” of Summit immediately

prior to the First Merger Effective Time or an “affiliate” of YS Biopharma following the Business Combination. Persons who may be deemed to be affiliates include individuals or entities that control, are controlled by, or are under common control with, YS Biopharma or Summit (as appropriate) and may include the executive officers, directors and significant shareholders of YS Biopharma or Summit (as appropriate).

#### **Stock Exchange Listing of YS Biopharma Ordinary Shares and YS Biopharma Warrants**

YS Biopharma will use reasonable best efforts to cause, prior to the First Merger Effective Time, the YS Biopharma Ordinary Shares and YS Biopharma Warrants issuable pursuant to the Business Combination Agreement to be approved for listing on Nasdaq under the symbols “YS” and “YSBPW”, respectively, subject to official notice of issuance. Approval of the listing on Nasdaq of the YS Biopharma Ordinary Shares (subject to official notice of issuance) is a condition to each party’s obligation to complete the Business Combination.

#### **Delisting and Deregistration of Summit Class A Ordinary Shares and Summit Warrants**

If the Business Combination is completed, the Summit Class A Ordinary Shares (i.e., Summit Public Shares) and Summit Warrants will be delisted from Nasdaq and will be deregistered under the Exchange Act.

#### **Charter Documents of YS Biopharma Following the Business Combination**

Pursuant to the Business Combination Agreement, immediately prior to the First Merger Effective Time, YS Biopharma’s memorandum and articles of association shall be amended and restated to read in their entirety in the form of the Amended YS Biopharma Articles attached as Exhibit E to the Business Combination Agreement. For a description of the Amended YS Biopharma Articles, see the section entitled “Description of YS Biopharma Securities.” For a comparison to the provisions of the Summit Articles, see the section entitled “Comparison of Corporate Governance and Shareholder Rights.”

#### **Background of the Business Combination**

Summit is a blank check company incorporated on December 22, 2020 as a Cayman Islands exempted company for the purpose of effecting a merger, share exchange, asset acquisition, share purchase, reorganization or similar business combination with one or more businesses or entities. Summit’s objective is to identify and acquire targets in the healthcare industry in Asia, with a focus on pharmaceuticals, medtech and diagnostics, though Summit reserved the right to pursue an acquisition opportunity in any business or industry.

On June 11, 2021, Summit consummated the IPO of 20,000,000 Units, at a price of \$10.00 per Unit, generating gross proceeds of \$200,000,000, and a concurrent private placement with the Sponsor of 6,000,000 Summit Private Warrants at a price of \$1.00 per warrant, generating gross proceeds of \$6,000,000. Each Unit consists of one Summit Class A Ordinary Share and one-half of one redeemable Summit Public Warrant. A total of \$200,000,000 from the net proceeds of the sale of the Units in the IPO and the sale of the Summit Private Warrants was placed in a U.S.-based trust account (the “Trust Account”) with Continental Stock Transfer & Trust Company acting as trustee.

Prior to the consummation of the IPO on June 11, 2021, neither Summit, nor anyone on its behalf, contacted any prospective target business or had any substantive discussions, formal or otherwise, with respect to any potential business combination transaction with Summit. After the completion of the IPO and consistent with Summit’s business purpose, Summit’s directors and management team commenced an active, targeted search for an initial set of potential business combination targets, leveraging Summit’s and the Sponsor’s network of relationships and intimate knowledge of the private company marketplace, as well as the prior experience and network of Summit’s directors and management team.

In evaluating potential businesses and assets for an initial business combination, Summit, together with its management team and the Sponsor, considered acquisition candidates across various industry categories. Summit generally focused on: (i) companies in the pharmaceutical, medtech and diagnostics industries seeking to benefit from the growing consumption power of Chinese patients and greater affordability driven by increasing disposable income, (ii) portfolio companies that have suffered from under-investment or could have greater potential under our active management, and (iii) highly innovative and differentiated companies



lacking the capital and local resources to fully realize the potential of their products outside of their home markets, especially in underpenetrated areas where the lack of treatment options has resulted in a large gap between the global and Asian markets. When evaluating potential targets, Summit generally judged opportunities against these criteria, in addition to others.

The following is a brief description of the background of Summit's search for and discussion with various potential target companies.

From the consummation date of Summit's IPO on June 11, 2021 through September 29, 2022, the execution date of the Business Combination Agreement with YS Biopharma, Summit considered a total of 59 potential target companies (including YS Biopharma) with the objective of consummating a business combination. Summit and its representatives contacted and were contacted by a number of individuals and entities who offered to present ideas and opportunities for a business combination, including financial advisors and companies that have their operations in either the United States or Asia. Summit compiled a list of potential targets and updated and supplemented such list from time to time.

During that period, Summit and its representatives:

- identified and evaluated 59 potential target businesses (including YS Biopharma) within the healthcare industry;
- among the companies it had evaluated, Summit executed non-disclosure agreements with 17 potential targets businesses or their representatives (including YS Biopharma) in order to receive further detailed information about these potential targets;
- Summit's representative and management engaged in discussions directly with the senior executives and/or representatives of YS Biopharma and 13 alternative potential targets; and
- among the 13 alternative potential targets, Summit issued a letter of intent and entered into substantive due diligence and negotiations with seven potential target businesses (other than YS Biopharma). In addition, Summit executed a letter of intent and entered into substantive due diligence and negotiations with YS Biopharma.

From around June 14, 2021, Summit's management and board were introduced to various potential acquisition targets by Summit's advisors and contacts of Summit's management and board that might potentially meet the Summit management team's preliminary target selection criteria. Summit's management reviewed, among other things, the financial performance, management team, industry and a description of each potential candidate. Following such initial review, Summit's search team selected preliminarily qualified candidates and continued with second stage review by conducting conference calls and collecting more detailed business information of the candidates.

From June 14, 2021 to May 30, 2022, Summit held a number of internal meetings to discuss preliminary candidates. At each meeting, Summit reviewed and discussed the qualifications of those candidates. In reviewing 59 potential targets (including YS Biopharma) from time to time, and holding discussions with their respective management, Summit focused on seven other potential companies before Summit identified YS Biopharma as a preferred acquisition target.

*Company A.* On or around June 21, 2021, Summit's team reached out to Chairman of Company A, a biotech company that focuses on launching global innovative drugs in China market. Around June 25, 2021, after reviewing basic information of Company A, Summit's management determined to proceed the discussion with Company A about diligence questions for a potential merger. Around July 5, 2021, Summit issued a non-binding letter of intent to Company A. Around July 30, 2021, Summit decided not to proceed with Company A because Summit could not reach consensus on the company valuation with Company A.

*Company B.* On or around July 8, 2021, Company B was referred to Summit's team through a financial advisor for Company B. Company B is a molecular diagnostics company. On July 10, 2021, after reviewing basic information of Company B, Summit's management determined to proceed the discussion with Company B about diligence questions for a potential merger. On August 21, 2021, Summit issued a non-binding letter of intent to Company B. At the end of October 2021, Summit decided not to proceed with Company B because Company B decided to pursue alternative funding strategies.

*Company C.* On or around July 8, 2021, Company C was referred to Summit's team through a financial advisor for Company C. Company C is a 3D printing ecosystem provider for dental professionals and practices. On July 10, 2021, after reviewing basic information of Company C, Summit's management determined to proceed the discussion with Company C about diligence questions for a potential merger. On April 19, 2022, Summit issued a non-binding letter of intent to Company C. Around May 12, 2022, Summit decided not to proceed with Company C because Company C decided to pursue alternative funding strategies.

*Company D.* On or around the July 10, 2021, Company D was referred to Summit's team through a financial advisor for Company D. Company D is a biotech company that focuses on biologics on autoimmune and oncology diseases. Around July 23, 2021, after reviewing basic information of Company D, Summit's management determined to proceed the discussion with Company D about diligence questions for a potential merger. On July 30, 2021, Summit issued a non-binding letter of intent to Company D. At the end of August 2021, Summit decided not to proceed with Company D because Company D decided to pursue alternative funding strategies.

*Company E.* On or around October 22, 2021, Company E was referred to Summit's team through a financial advisor for Company E. Company E is a Europe-based medical aesthetics company. On October 23, 2021, after reviewing basic information of Company E, Summit's management determined to proceed the discussion with Company E about diligence questions for a potential merger. Around October 30, 2021, Summit issued a non-binding letter of intent to Company E. At the end of December 2021, Summit decided not to proceed with Company E because Summit decided to focus on geographic areas where it has clear value-add.

*Company F.* On or around October 25, 2021, Company F was referred to Summit's team by the Chairman of Company F. Company F is a specialty hospital group in China. On October 18, 2021, after reviewing basic information of Company F, Summit's management determined to proceed the discussion with Company F about diligence questions for a potential merger. On November 9, 2021, Summit issued a non-binding letter of intent to Company F. At the end of December 2021, Summit decided not to proceed with Company F as Summit decided to focus on other targets with which it was in advanced discussion.

*Company G.* On or around the December 1, 2021, Summit management reached out to CEO of Company G, which is a biotech company that focuses on using innovative small molecules to tackle oncology diseases. Around December 6, 2021, after reviewing basic information of Company G, Summit's management determined to proceed the discussion with Company G about diligence questions for a potential merger. On January 10, 2022, Summit issued a non-binding letter of intent to Company G. Around January 20, 2022, Summit decided not to proceed with Company G because Company G decided to postpone the plan for its U.S. listing due to the market environment.

In respect to other alternative potential targets, the reasons that discussions did not continue included (1) target voluntarily ceased their plans for business combination with a SPAC, (2) a difference in valuation expectations, sometimes driven by IPO alternatives, (3) belief of Summit's management and the Summit Board that the alternative potential target is less attractive than YS Biopharma with respect to factors such as competitive positioning, management experience and technologies, and (4) the target business chose to pursue business combination with another SPAC.

#### ***Timeline of the Business Combination***

On May 7, 2022, YS Biopharma's senior management team reached out to the Sponsor.

On May 8, 2022, YS Biopharma provided Summit with presentation materials introducing its business. On the same day and over the next few days, Summit's management team reviewed those materials and had a general understanding of YS Biopharma's operations, business model, technologies, and investment highlights. Summit's management discussed a potential business combination with YS Biopharma, and whether such transaction was compatible with Summit's timeline for completing a business combination.

On May 11, 2022, Summit and YS Biopharma entered into a confidentiality agreement. On the same day, Summit and YS Biopharma held their first formal meeting, which was attended by YS Biopharma's senior management and Summit's management team. The parties discussed a potential business combination. YS Biopharma also granted data room access to the Summit management team.

On May 20, 2022, Summit and YS Biopharma held a follow-up in-depth due diligence session, which was attended by YS Biopharma's senior management and Summit's management team. The parties discussed topics including YS Biopharma's history, business model, technologies, products and pipelines, management team background, suppliers and customers.

From May 20 to May 30, 2022, Summit reviewed documents in the data room and compiled follow up requests and diligence questions. Summit requested further information to better understand YS Biopharma's technologies, core products and pipelines and their underlying markets, competitive landscape, clinical trial progress, clinical development plans, manufacturing capacities, and financials.

On May 30, 2022, Summit provided YS Biopharma with a first draft of a non-binding letter of intent (the "First Draft LOI") for a potential business combination between Summit and YS Biopharma, which included (i) a non-binding term sheet that specified an initial pre-money equity valuation of YS Group of \$814 million, representing approximately \$2.44 per share (prior to the YS Biopharma Share Consolidation) based on factors including historical valuations of YS Group in connection with YS Group's prior equity financings and comparison of public traded comparable companies, (ii) an exclusivity period that is 30 days after the execution of the letter of intent, subject to extension under certain conditions, and (iii) a provision that the Sponsor shall have the right to appoint at least one director on the board of the combined company post-closing.

On June 11, 2022, YS Biopharma sent Summit a revised version of the First Draft LOI (the "Second Draft LOI"), which proposed a pre-money equity value of YS Group of \$836 million, which was based on a newly proposed share price of \$2.50 per share (prior to the YS Biopharma Share Consolidation) considering the overall stock market condition. The Second Draft LOI further proposed the following material revisions to the First Draft LOI: 1) an exclusivity period of 60 days instead of 30 days, subject to extension under certain conditions; 2) a proposed equity financing arrangement under which the Forward Purchase Investors will purchase Summit Ordinary Shares and Summit Warrants for an aggregate of \$30 million upon Summit's exercise of its right under the Forward Purchase Agreements; 3) the issuance of the combined company's securities upon closing of the Business Combination as compensation shares for the Forward Purchase Investors and non-redeeming Summit Public Shareholders; 4) the share exchange mechanism immediately prior to the closing of the Business Combination; 5) certain customary closing conditions to the Business Combination, including a minimum available cash amount of \$50 million; 6) proposed lock-up arrangements; and 7) certain termination and miscellaneous provisions.

Upon receipt of the Second Draft LOI, representatives from both Summit and YS Biopharma discussed the key terms in the Second Draft LOI, including, without limitation, the initial pre-money valuation, commitment by Forward Purchase Investors, timing on the execution of a definitive agreement and closing conditions. Following further discussions between the parties, on June 17, 2022, YS Biopharma sent Summit a revised version of the Second Draft LOI (the "Third Draft LOI") which reflected the parties' agreement on major commercial points outlined in the Second Draft LOI with necessary modifications on the wordings, including further clarification on the compensation shares arrangement for the Forward Purchase Investors and non-redeeming Summit Public Shareholders that was proposed in the Second Draft LOI.

On June 22, 2022, Summit provided YS Biopharma with a further revised version of the Third Draft LOI (the "Fourth Draft LOI"), which further modified the language on the compensation shares arrangement for the Forward Purchase Investors and non-redeeming Summit Public Shareholders and reduced the minimum available cash amount from \$50 million to \$30 million to reflect the parties' agreement. In addition, Summit proposed in the Fourth Draft LOI that the target date to execute a definitive agreement shall be no later than July 31, 2022, provided that YS Biopharma shall have (i) obtained approval from its shareholders and board of directors of the proposed Business Combination prior to the signing of such definitive agreement to improve deal certainty and (ii) completed and delivered the audited financial statements of YS Group, which shall be in compliance with the auditing standards of the PCAOB, prior to the signing of such definitive agreement.

On June 26, 2022, following further discussions between the parties, YS Biopharma sent Summit a further revised version of the Fourth Draft LOI (the "Fifth Draft LOI"), which clarified parties' intentions on a few items, including, among other things, (i) considering the progress of the audit work, YS Biopharma shall complete and provide Summit with its PCAOB compliant audited financial statements no later than August 31, 2022, on a best efforts basis, (ii) the Sponsor shall have the right to appoint no more than two directors (among whom the Sponsor shall have the obligation to appoint Mr. Bo Tan as a director) to the board of the combined

company post-closing, and (iii) Summit shall notify YS Biopharma and seek its prior consent for issuance of any additional equity or equity-link securities during the exclusivity period.

On July 1, 2022, Summit and YS Biopharma executed the letter of intent (the “Final LOI”) that included all material terms outlined in the Fifth Draft LOI. The Final LOI was non-binding, except for exclusivity, transaction expenses, confidentiality, termination, and other miscellaneous provisions thereof. The Final LOI outlined the proposed terms for the Business Combination for discussion purposes, including, among other things, transaction structuring considerations, sources and uses of capital, a pre-money equity value of YS Group of \$836 million, a compensation shares arrangement where the Forward Purchase Investors and non-redeeming Summit Public Shareholders will exchange their Summit Shares for the shares of the combined company at an exchange ratio (between 1.12 and 1.43) that will increase with the redemption rate, and be capped at 1.43 when the redemption rate is equal to or higher than 85%, an exclusivity period of 60 days, subject to extension under certain conditions, proposed closing conditions, timing for signing of a Business Combination Agreement, proposed post-closing corporate governance mechanisms, and potential lock-up arrangements with respect to the combined company’s securities post-closing.

On July 19, 2022, Summit’s legal counsel, Cooley LLP (“Cooley”) shared a diligence request list with YS Biopharma’s legal counsel, Wilson Sonsini Goodrich & Rosati (“WSGR”).

On July 19, 2022, Summit retained ValueScope, Inc. (“ValueScope”) to serve as an independent financial advisor to the Summit Board, specifically to provide to the Summit Board a fairness opinion in connection with the Business Combination. ValueScope received customary fees from Summit for its services, in the amount of \$90,000, \$45,000 of which was paid upon Summit’s retention, and the additional \$45,000 was paid subsequent to ValueScope’s issuance of the draft fairness opinion and prior to the issuance of the final version of the fairness opinion. No portion of ValueScope’s fee was contingent upon the conclusion reached in its opinion. Other than the aforementioned services, ValueScope and its affiliates have not provided any additional services in connection with the proposed Business Combination or otherwise to Summit, YS Biopharma or their respective affiliates. In selecting ValueScope, the Summit Board considered, among other things, the fact that ValueScope is regularly engaged in the valuation of businesses and their securities and the provision of fairness opinions in connection with various transactions.

From July 20 to September 15, 2022, ValueScope conducted due diligence on Summit and YS Biopharma. For procedures completed by ValueScope in connection with its financial analysis and delivery of the fairness opinion (the “Fairness Opinion”), see the section entitled “— Summary of Valuation Analysis and Opinion of Financial Advisor to the Summit Board — Procedures” below.

From July 22 to August 5, 2022, Summit’s management and legal team and its legal advisors, conducted due diligence on YS Biopharma, including but not limited to review of YS Biopharma’s corporate documents, shareholder matters, financing documents and other material agreements.

In July 2022, several discussions were held among representatives of Summit, YS Biopharma, Cooley, WSGR, tax advisors of YS Biopharma, on the proposed deal structure, including tax implications. On August 1, 2022, Summit’s management and Cooley discussed the tax implications of the proposed deal structure via a conference call.

On August 4, 2022, Cooley sent WSGR and YS Biopharma an initial draft of the Business Combination Agreement, reflecting the initial discussions among the parties regarding the deal structure. In August 2022 and subsequent to the initial circulation of the draft Business Combination Agreement, WSGR and Cooley exchanged drafts of the Business Combination Agreement and related ancillary documents, the most significant exchanges of which are summarized in more details below, and in connection with each exchange, they also held a number of phone discussions and video-conferences regarding the Business Combination Agreement and ancillary documents. In connection with these draft exchanges and discussions, Cooley and WSGR also had regular contact with their respective clients during this period to keep them apprised of the status of the Business Combination Agreement and related ancillaries and also solicited their feedback in connection with the negotiation of the documents. The principal terms of the Business Combination Agreement and related ancillary documents being negotiated during such time related to, among other things, (i) the structure and terms of the Business Combination as contemplated in the Business Combination Agreement, (ii) the scope of the representations, warranties and covenants, (iii) the applicable conditions and

approvals required to consummate the Business Combination, (iv) corporate governance of YS Biopharma, including the Amended YS Biopharma Articles and board composition upon the consummation of the Business Combination, (v) the scope and terms of Shareholder Support Agreement, Warrant Assignment Agreement and other ancillary documents relating to the Business Combination.

On August 2 and August 4, 2022, Cooley and WSGR had further discussions regarding details of the deal structure, focusing on alternative transaction structures and related documentation, legal and tax considerations and closing mechanics. On August 8, 2022, Summit, YS Biopharma, Cooley and WSGR discussed and aligned on the currently proposed transaction structure of the Business Combination.

On August 12, 2022, WSGR sent Cooley a revised draft of the Business Combination Agreement that proposed revisions to items, including, among other things, the structure of the Business Combination, the overall suite of representations, warranties and covenants to be provided by each party under the Business Combination Agreement, which include the scope of the interim operating covenants of YS Biopharma and Summit, the conditions to closing, and the scope of the right to termination of each party under the Business Combination Agreement.

On August 16, 2022, Cooley and WSGR held a telephone conference to further discuss the revisions proposed in the above-mentioned revised draft of the Business Combination Agreement.

From August 19 to September 23, 2022, Cooley and WSGR exchanged drafts of Business Combination Agreement and ancillary documents relating to the Business Combination Agreement. During the same period, YS Biopharma and Summit agreed to update the pre-money equity value of YS Group from \$836 million as set forth in the Final LOI to \$834 million to reflect the reduced number of total outstanding YS Biopharma Ordinary Shares, without amending the \$2.50 per share value (prior to the YS Biopharma Share Consolidation).

On September 1, 2022, YS Biopharma, Summit, WSGR and Cooley held a telephone conference to further discuss certain key outstanding provisions under the Business Combination Agreement, including, among other things, the scope of the covenants, the applicable conditions and approvals required to consummate the Business Combination, and the lock-up arrangement after the consummation of the Business Combination.

On September 21, 2022, the Summit Board held a meeting via video conference, attended by all members of the Summit Board (including all members on the audit committee of the Summit Board). At this meeting, ValueScope presented to the Summit Board its financial analysis with respect to the consideration to be paid by Summit in the Business Combination; members of Summit's management team presented to the Summit Board a review of the key transaction terms of the Business Combination, including the Business Combination Agreement and related agreements; and David Shao, Chief Executive Officer of YS Biopharma provided an overview of YS Biopharma's business, industry and performance in recent years. At the end of each presentation, questions were raised by the members of the Summit Board, discussed, and addressed by the presenter.

Later on the same day, the audit committee of the Summit Board which is comprised entirely of independent directors held a meeting via video conference, attended by all members of the audit committee of the Summit Board, to discuss the proposed Business Combination.

On September 23, 2021, the YS Biopharma board of directors unanimously approved YS Biopharma's entry into the Business Combination Agreement and ancillary documents, as well as other corporate matters in connection with the Business Combination.

On September 23, 2022, YS Biopharma held a shareholders' meeting via video conference, where YS Biopharma's shareholders representing over two-thirds of the total voting power attended in person or by proxy and (including the Majority Preferred Shareholders (as defined in the memorandum and articles of association of YS Biopharma prior to the consummation of the Business Combination)) voted in favor of YS Biopharma's entry into the Business Combination Agreement and ancillary documents, as well as other corporate matters in connection with the Business Combination.

On September 27, 2022, ValueScope issued the final version of its written Fairness Opinion to the Summit Board.

On September 29, 2022, upon review of the signed Fairness Opinion and the final draft of the Business Combination Agreement and the related agreement, the audit committee of the Summit Board signed the unanimous written resolutions, approving the Business Combination Agreement, the related agreements and the transactions contemplated thereby.

Later on the same day, upon review of the signed Fairness Opinion, the final draft of the Business Combination and the related agreements, the signed unanimous written resolutions of Summit's audit committee, the Summit Board signed the unanimous written resolutions approving the Business Combination Agreement, the related agreements and the transactions contemplated thereby.

On September 29, 2022, Summit and YS Biopharma executed the Business Combination Agreement and ancillary agreements and documentation related thereto. Thereafter, Summit and YS Biopharma issued a joint press release announcing the execution of the definitive Business Combination Agreement and related agreements.

#### **Reasons for Summit Board's Approval of the Business Combination**

In evaluating the transaction with YS Biopharma, the Summit Board consulted with Cooley, its legal counsel, ValueScope, its independent financial advisor, and Ogier, its legal counsel as to Cayman Islands law, as well as the YS Biopharma management. In determining that the terms and conditions of the Business Combination Agreement and the transactions contemplated thereby are in Summit's best interests, the Summit Board considered and evaluated a number of factors, including, but not limited to, the factors discussed below. In light of the number and wide variety of factors considered in connection with its evaluation of the Business Combination Agreement and the transactions contemplated thereby, the Summit Board did not consider it practicable to, and did not attempt to, quantify or otherwise assign relative weights to the specific factors that the Summit Board considered in reaching its determination and supporting its decision. The Summit Board viewed its decision as being based on all of the information available and the factors presented to and considered by the Summit Board. In addition, individual directors may have given different weight to different factors. The Summit Board realized that there can be no assurance about future results, including results considered or expected as disclosed in the following reasons. This explanation of the Summit Board's reasons for the Business Combination and all other information presented in this section is forward-looking in nature and, therefore, should be read in light of the factors discussed under "Forward-Looking Statements."

The members of the Summit Board are well qualified to evaluate the Business Combination. The Summit Board and Summit's management collectively have extensive transactional experience, particularly in the healthcare, life science and technology sectors.

The Summit Board considered a wide variety of factors pertaining to the Business Combination Agreement and the transactions contemplated thereby. In particular, the Summit Board considered, among other things, the following factors, although not weighted or in any order of significance:

- *YS Biopharma satisfies a number of acquisition criteria that Summit had established to evaluate prospective business combination targets.* The Summit Board considered the business, history, prospect, credibility and valuation of YS Biopharma and its affiliates ("YS Group"), and determined that YS Biopharma satisfies a number of criteria and guidelines set forth in Summit's prospectus for the IPO, including (i) strong understanding of Chinese market and local intelligence, (ii) differentiated technology, and (iii) strong management team.
- *YS Group's marketed rabies vaccine with track record of commercialization and significant revenue potential.* YS Group is a biopharmaceutical company with innovative technology and a revenue-generating marketed product with robust growth potential. Its YSJA™ rabies vaccine is the first aluminum-free lyophilized rabies vaccine launched in China, according to the F&S Report, and approximately 97 doses have been administered to patients for post-exposure protection against rabies. YSJA™ rabies vaccine has demonstrated critical advantages in product characteristics and manufacturing, which makes it attractive for commercialization. As an early entrant in the rabies vaccine industry with a marketed product and an established distribution network, the Summit Board believes that YS Group is well-positioned to capture the fast-growing and vast market in China, which fits Summit's business combination criteria as a target in the healthcare and pharmaceutical industry with a strong China nexus to benefit from the growing consumption power of Chinese patients and greater affordability driven by increasing disposable income.

- YS Group's next-generation product candidate, PIKA rabies vaccine with accelerated regimen and broad protection against multiple virus strains leads to potentially elevated standard of care and favorable and promising market outlook.* YS Group is developing its next-generation product candidate, PIKA rabies vaccine featuring accelerated regimen and broad protection against multiple virus strains. PIKA rabies vaccine is a clinical-stage product candidate. The clinical studies to date have shown that PIKA rabies vaccine can be used under an accelerated regimen, which achieves protective level of neutralizing antibodies as early as seven days post vaccination and elicit more robust immunogenic response compared to that of the control arm vaccine, which is a widely used commercially available vaccine. The Summit Board believes that PIKA rabies vaccine, if approved, enables YS Biopharma to capture the future rabies vaccines market demand in emerging markets with its competitive advantages.
- YS Group's strong research and development capabilities underpinned by innovative PIKA immunomodulating technology platform.* YS Group has built its business upon strong in-house research and development capabilities. Its in-house developed PIKA immunomodulating technology platform has the potential to generate innovative vaccines. YS Biopharma has developed its PIKA immunomodulating technology platform to empower a pipeline of vaccines and therapeutic biologics. The Summit Board believes YS Group's strong R&D and product innovation capability ensures that its vaccines and therapeutic biologics products remain differentiated from those of its peers and creates entry barriers.
- YS Group's robust portfolio of innovative vaccines and therapeutic biologics to drive sustainable value creation.* Leveraging its PIKA immunomodulating technology platform, YS Biopharma has a robust portfolio of innovative product candidates to address the unmet needs in preventing and/or treating infectious diseases and cancer, including (1) four product candidates under various clinical development stages, including PIKA rabies vaccine, PIKA recombinant COVID-19 vaccine, PIKA YS-ON-001 and PIKA YS-HBV-001, among which PIKA rabies vaccine and PIKA YS-ON-001 are categorized under Category I drugs by the NMPA, which are drugs that have a new and clearly defined structure, pharmacological property and apparent clinical value and have not been marketed anywhere in the world, and (2) four preclinical stage product candidates targeting COVID-19, HBV, influenza, rabies and cancer with enormous medical demand. The Summit Board believes that the comprehensive portfolio of product candidates with commercialization potential will allow YS Group to diversify its revenue sources, sustain its growth and strengthen its competitive advantages.
- YS Group's established clinical development and manufacturing capability to prepare product launch.* The development of adjuvanted vaccines is a specialized and sophisticated field in the biotechnology industry, and YS Group's clinical team has built up first-hand experience in adjuvant selection, dose optimization, study design and pharmaco-vigilance, all of which are crucial to the successful development and application of adjuvants. The manufacture of vaccines is a complex and lengthy process which directly determines the quality and safety and thus the commercial success of vaccine products. The capability to manufacture vaccines on a commercial scale requires in-depth expertise and process know-how, presenting a significant entry barrier against potential competition. YS Group has accumulated extensive and excellent experience in vaccine manufacturing and commercialization, which the Summit Board believes that it will enable YS Group to apply its established clinical development and manufacturing capability to launch its product candidates and new revenue-generating product lines cost-effectively and successfully.
- YS Group has established expansive sales network and demonstrated commercialization capabilities.* With track record in commercializing YSJA™ rabies vaccine, YS Group has established its expansive sales network and demonstrated its commercialization capabilities. As of September 30, 2022, it had built an experienced in-house commercialization team with approximately 40 team members and collaborated with about 120 external service providers to achieve expansive coverage across the country. In addition, it has also obtained qualifications from 30 province-level CDCs and had sold more than 16 million doses to approximately 1,625 county-level CDCs. The Summit Board believes that YS Group's product candidates will benefit from the operating leverage enabled by its established and highly scalable commercialization infrastructure, expertise and strategy to rapidly achieve market success.
- Seasoned existing management team with local expertise and global vision and backed by blue-chip investors.* The Summit Board considered that YS Biopharma's management team has comprehensive and complementary capabilities in the vaccine industry, spanning from early research and development,

manufacture to commercialization: (i) Mr. Yi Zhang, the founder of YS Biopharma who will serve as the chairman of YS Biopharma upon closing of the Business Combination, has over 35 years of experience in China's biopharmaceutical industry and has led various successful national research projects; (ii) Mr. Hui Shao, the chief executive officer and director of YS Biopharma who will serve as the chief executive officer and director of YS Biopharma upon closing of the Business Combination, has over 25 years of distinguished scientific and industrial background in biotechnology and pharmaceutical fields ranging from drug discover, business strategy and product commercialization to private and public capital market in the United States, Europe and Asia, and (iii) YS Group has been led by a strong team of senior management with diversified and complementary skillsets and expertise to support YS Group's transformational growth, and such management team will continue to manage YS Biopharma and drive its business growth after closing of the Business Combination.

- *Commitment by existing shareholders of YS Biopharma.* The Summit Board noted that (i) YS Biopharma's existing shareholders would not be receiving any cash consideration in connection with the Business Combination; (ii) YS Biopharma's existing shareholders will continue to own approximately 73.5% of YS Biopharma on a fully-diluted basis immediately after the Closing (assuming no redemptions by Summit Public Shareholders and there are no Dissenting Summit Shareholders and the consummation of the Forward Purchase Subscriptions); and (iii) YS Biopharma's existing shareholders will be subject to a 180-day lock-up of the YS Biopharma Ordinary Shares to be held by them immediately after consummation of the Business Combination, subject to limited exceptions and YS Biopharma's right to release certain lock-up obligations. The Summit Board considered these to be strong signs of YS Biopharma shareholders' confidence in YS Biopharma, as the combined public company after the consummation of the Business Combination, and the benefits to be realized as a result of the Business Combination.
- *Platform for future development and expansion.* The cash proceeds available to YS Biopharma upon closing of the Business Combination and YS Biopharma's access to the public capital markets through the Business Combination are expected to provide YS Biopharma with an optimal platform and strong financial foundation for its further development and business expansion.
- *Reasonable valuation.* The Summit Board considered that the valuation of YS Biopharma under the terms of the Business Combination Agreement, reflected a reasonable valuation for the YS Group's business on an appropriately risk-adjusted basis.
- *Certainty of closing of the Business Combination.* On the basis that (i) the closing of the Business Combination is not subject to regulatory review, report or pre-approval under the applicable anti-trust or competition laws in effect as of the date hereof in the jurisdictions in which YS Biopharma has business operations, thereby reducing the uncertainty and regulatory risk in connection with completing the Business Combination; (ii) the Business Combination Agreement and the transactions contemplated thereby have been approved by the shareholders of YS Biopharma; (iii) pursuant to the Forward Purchase Agreements, the Forward Purchase Investors have agreed to purchase Summit Ordinary Shares and Summit Warrants for an aggregate price equal to \$30,000,000 immediately prior to the First Merger Effective Date, which is sufficient to cover the minimum Available Closing Cash Amount (as defined in the Business Combination Agreement) required to meet a condition to Closing under the Business Combination Agreement; and (iv) pursuant to the Shareholder Support Agreement, the Supporting Shareholders (including, among other persons, the Sponsor and certain existing shareholders of YS Biopharma) have agreed to vote against (or act by written consent against) any alternative proposals or actions that would impede, interfere with, delay, postpone or adversely affect the transactions contemplated by the Business Combination Agreement, the Summit Board expected that the Business Combination has a reasonable likelihood to be consummated pursuant to the terms and conditions of the Business Combination Agreement.
- *Independent directors' role.* The Summit Board is comprised of a majority of independent directors and the audit committee of the Summit Board is comprised entirely of independent directors. On March 16, 2022, HK Yisheng, a subsidiary of YS Biopharma, entered into a facility agreement (the "Facility Agreement") with, among other parties, R-Bridge Investment Three Pte. Ltd, as the original lender ("R-Bridge"). R-Bridge is 100% owned by R-Bridge Healthcare Fund L.P. ("R-Bridge Fund"). Mr. Wei Fu, the Honorary Chairman and Senior Advisor of Summit and one of the managers of the Sponsor, is the sole director of R-Bridge and one of the investment committee members of R-Bridge Fund. To manage any potential conflicts of interest involving the Sponsor that may arise from the Facility Agreement, the Business



Combination Agreement, the related agreements and the transactions contemplated thereby, were reviewed, assessed and unanimously approved by the audit committee of Summit prior to approval of the Summit Board. In addition, Summit has retained ValueScope as an independent financial advisor to the Summit Board, specifically to provide to the Summit Board a fairness opinion in connection with the Business Combination from a financial point of view.

In the course of its deliberations, the Summit Board also considered a variety of risks and uncertainties relevant to the transaction, including, among other things, the following:

- *Certain Key Risks Related to the Business Combination.*
  - The process of taking a company public by means of a business combination with a special purpose acquisition company is different from taking a company public through a traditional initial public offering and may create risks for our unaffiliated investors.
  - Summit's current directors and officers and their affiliates have interests that are different from, or in addition to (and which may conflict with), the interests of its shareholders, and therefore potential conflicts of interest exist in recommending that shareholders vote in favor of approval of the Business Combination. Such conflicts of interests include that the Sponsor as well as Summit's directors and officers are expected to lose their entire investment in Summit if the Business Combination is not completed.
  - The exercise of Summit's directors' discretion in agreeing to changes or waivers in the terms of the Business Combination may result in a conflict of interest when determining whether such changes to the terms of the Business Combination or waivers of conditions are appropriate and in Summit's best interest.
  - If the Mergers do not qualify as a "Reorganization" within the meaning of Section 368(a) of the Code, then the Mergers generally will be taxable to U.S. Holders.
- *Certain Key Risks Related to YS Biopharma's Business and Product.*
  - YS Group depends on its current marketed rabies vaccine to generate substantially all of its revenue in the near term. YS Group's previous operating history of manufacturing and commercializing vaccines may not provide an adequate basis to judge the viability of its business, the effectiveness of its management and its future profitability and prospects in respect of its marketed product.
  - YS Group faces substantial competition. YS Group's competitors may discover, develop or commercialize products before, or more successfully than, YS Group do, or develop therapies that are more advanced or effective than those of YS Group, which may adversely affect YS Group's financial condition and its ability to successfully market or commercialize its marketed product and product candidates.
  - YS Group's product candidates, once commercialized, may compete with its existing marketed product.
  - YS Group's success depends substantially on the success of its product candidates in preclinical or clinical trial stages. Preclinical or clinical trials involve a lengthy and expensive process with uncertain outcomes. YS Group may not be able to achieve its projected development goal of its product candidates in a timely manner or at all, which may materially and adversely affect YS Group's business, financial condition, results of operations and prospects.
  - Preclinical and clinical studies involve a lengthy and expensive process with an uncertain outcome. YS Group may incur additional costs or experience delays in completing preclinical or clinical studies, or ultimately be unable to complete the development and commercialization of YS Group's product candidates.
- *Certain Key Risks Related to Doing Business in China.*
  - YS Group has a substantial business and operation in China and thus is exposed to legal and operational risks associated with its operations in China. The PRC government has significant authority to exert influence on the ability of a company with operations in China, including YS Group, to conduct its business. Changes in China's economic, political or social conditions or government policies could materially and adversely affect YS Group's business and results of operations. For

example, YS Group faces risks associated with regulatory approvals of offshore offerings, anti-monopoly regulatory actions, oversight on cybersecurity and data privacy, as well as the lack of PCAOB inspection on its auditors. On December 16, 2021, the PCAOB issued a report to notify the SEC of its determination that it is unable to inspect or investigate completely PCAOB-registered public accounting firms headquartered in mainland China and Hong Kong without the approval of the Chinese authorities. While YS Biopharma's auditor, Wei, Wei & Co., LLP, is headquartered in the United States and not subject to such determinations, there is no guarantee that the audit work carried out by Wei, Wei & Co., LLP in collaboration of its China-based offices can be inspected or investigated completely by the PCAOB without such approval. On August 26, 2022, the PCAOB signed a Statement of Protocol with the CSRC and the Ministry of Finance of the People's Republic of China, taking the first step toward opening access for the PCAOB to inspect and investigate registered public accounting firms headquartered in mainland China and Hong Kong. While significant, the Statement of Protocol is only a first step. Uncertainties still exist as to whether and how this new Statement of Protocol will be implemented. On December 15, 2022, the PCAOB announced that it was able to secure complete access to inspect and investigate PCAOB registered public accounting firms headquartered in mainland China and Hong Kong completely in 2022. The PCAOB Board vacated its previous 2021 determinations that the PCAOB was unable to inspect or investigate completely registered public accounting firms headquartered in mainland China and Hong Kong. However, whether the PCAOB will continue to be able to satisfactorily conduct inspections of PCAOB-registered public accounting firms headquartered in mainland China and Hong Kong is subject to uncertainties and depends on a number of factors out of our and our auditor's control. The PCAOB continues to demand complete access in mainland China and Hong Kong moving forward and is making plans to resume regular inspections in early 2023 and beyond, as well as to continue pursuing ongoing investigations and initiate new investigations as needed. The PCAOB has also indicated that it will act immediately to consider the need to issue new determinations with the HFCAA if needed. YS Biopharma could still face the risk of delisting and cease of trading of its securities from a stock exchange or an over-the-counter market in the United States under the Holding Foreign Companies Accountable Act and the securities regulations promulgated thereunder if the PCAOB determines in the future that it is unable to completely inspect or investigate YS Biopharma's auditor which has a presence in China in 2023 and beyond or if YS Biopharma fails to, among others, meet the PCAOB's requirements, including retaining a registered public accounting firm that the PCAOB determines it is able to inspect and investigate completely. These China-related risks could result in a material change in its operations and/or the value of YS Biopharma's securities, or could significantly limit or completely hinder the ability of YS Biopharma to offer or continue to offer securities to investors and cause the value of such securities to significantly decline or become worthless. See the section entitled "Risk Factors — Risks Related to Doing Business in China."

- The PRC government has significant oversight and discretion over the conduct of YS Group's business and operations and may intervene with or influence its operations as the government deems appropriate to further regulatory, political and societal goals. Recent policy statements and regulatory actions by the PRC government, such as those related to human genetic data and biopharmaceutical and vaccine business, may adversely impact YS Biopharma's ability to conduct its business and R&D activities, accept foreign investments, or list on a U.S. or other foreign stock exchange, which may cause the securities of YS Biopharma to be prohibited from trading or to be delisted from the Nasdaq Global Market or any other U.S. stock exchange. Furthermore, the PRC government has recently indicated an intent to exert more oversight and control over overseas securities offerings and other capital markets activities and foreign investment in China-based companies like YS Group. Any such action, once taken by the PRC government, could significantly limit or completely hinder YS Biopharma's ability to offer or continue to offer securities to investors and cause the value of such securities to significantly decline or in extreme cases, become worthless. See the section entitled "Risk Factors — Risks Related to Doing Business in China."
- The M&A Rules purport to require offshore special purpose vehicles that are controlled by PRC companies or individuals and that have been formed for the purpose of seeking a public listing on an overseas stock exchange through acquisitions of PRC domestic companies or assets to obtain CSRC approval prior to publicly listing their securities on an overseas stock exchange. The interpretation and application of the M&A Rules remain unclear. YS Biopharma's PRC legal advisor has advised that,

based on its understanding of the M&A Rules, YS Biopharma will not be required to submit an application to the CSRC for its approval of this Business Combination. Neither YS Biopharma nor any of its subsidiaries has obtained the approval or clearance from the CSRC for this Business Combination, and YS Biopharma does not intend to obtain the approval or clearance from any of such or other regulators in China in connection with this Business Combination unless it is required by CSRC to do so. There is no assurance, however, that regulators in China will not subsequently require YS Biopharma to undergo the approval or clearance procedures and subject YS Biopharma to penalties for non-compliance. See the section entitled “Risk Factors—Risks Related to Doing Business in China—Recent regulatory development in China may exert more oversight and control over listing and offerings that are conducted overseas such as the Business Combination. The approval and/or other requirements of PRC governmental authorities may be required in connection with the Business Combination or YS Biopharma’s future issuance of securities to foreign investors under PRC laws, regulations or policies.”

- *Risks Related to the Liquidation of Summit.* The risks and costs to Summit if the Business Combination is not completed, including the risk of diverting Summit management’s focus and resources from other business combination opportunities, which could result in Summit being unable to effect a business combination within 24 months from the closing of its IPO, and force Summit to liquidate and its warrants to expire worthless.
- *Other Risks.* Various other risks associated with YS Biopharma’s business or otherwise relating to the Business Combination, as described in the section titled “Risk Factors” herein.

In addition to considering the factors described above, the Summit Board also considered that certain Summit directors and officers as well as the Sponsor may have interests in the Business Combination as individuals that are in addition to, and that may be different from, the interests of Summit shareholders. The Summit Board reviewed and considered these interests during the negotiation of the Business Combination and in evaluating and approving the Business Combination Agreement and the transactions contemplated therein, including the Business Combination. See the section entitled “— Interests of Summit’s Directors, Officers and the Sponsor in the Business Combination” for a further discussion of these considerations.

While this discussion of the information and factors considered by the Summit Board includes the principal positive and negative factors, it is not intended to be exhaustive and may not include all of the factors considered by the Summit Board or any of its individual directors.

After considering the foregoing potentially negative and potentially positive reasons, the Summit Board concluded, in its business judgment, that the potential benefits that the Summit Board expected Summit and its shareholders to achieve as a result of the Business Combination outweighed the potentially negative factors associated with the Business Combination. Accordingly, the Summit Board determined that the Business Combination Agreement, the Business Combination, and the other transactions contemplated by the Business Combination Agreement, were in the best interests of Summit and Summit’s shareholders.

## **Summary of Valuation Analysis and Opinion of Financial Advisor to the Summit Board**

### ***Overview***

Although Summit’s management had specific experience in YS Biopharma’s sector, the Summit Board concluded that it would be in the best interest of the Summit’s shareholders to engage ValueScope as an independent financial advisor to the Summit Board to conduct a fairness analysis in light of the fact that the Sponsor’s interest in the Business Combination may be in addition to and/or different from the interests of Summit shareholders. For further discussions of the Sponsor’s interest in the Business Combination, see the section entitled “— Interests of Summit’s Directors, Officers and the Sponsor in the Business Combination.”

This summary of the Fairness Opinion of ValueScope is qualified and should be read in conjunction with the full text of the Fairness Opinion, which is included as **Annex D** of this proxy statement/ prospectus and describes the procedures followed, assumptions made, qualifications and limitations on the review undertaken and other matters considered by ValueScope. However, neither the Fairness Opinion nor this summary of the Fairness Opinion and the related analyses set forth in this proxy statement/prospectus are intended to be, and

do not constitute, advice or a recommendation to the Summit Board, Summit, any security holder or any other person as to how to act or vote or make any election with respect to any matter relating to the Business Combination or otherwise.

The Fairness Opinion issued by ValueScope was only one of many factors considered by the Summit Board in evaluating the Business Combination. Neither the Fairness Opinion nor ValueScope's analyses were determinative of the aggregate merger consideration or of the views of the Summit Board or Summit's management with respect to the Business Combination or the aggregate merger consideration. The type and amount of consideration payable in the Business Combination were determined through negotiations between Summit and YS Biopharma, and the decision to enter into the Business Combination Agreement was solely that of the Summit Board.

The following is a summary of ValueScope's valuation analysis. The following summary does not purport to be complete and is qualified in its entirety by reference to the Fairness Opinion of ValueScope, a copy of which is attached as **Annex D** to this proxy statement/prospectus.

#### *Procedures*

ValueScope's analyses relied upon, but were not necessarily limited to, the following procedures.

- A review of the documents related to the Business Combination and the terms thereof, including the Letter of Intent, dated as of July 1, 2022 and drafts of the definitive transaction documents.
- A review of the global vaccine industry and market expectations.
- A review of YS Biopharma's financial statements as of March 31, 2022.
- A review of financial and product projections prepared by YS Biopharma's management.
- Discussed the past and current operations, financial conditions, and the prospects of YS Biopharma with Summit and its advisors.
- A review of information relating to YS Biopharma's industry and comparable companies, including financial and share price information, as of March 31, 2022 (the "Valuation Date").
- A review of data of comparable companies and industry transactions existing as of the Valuation Date.
- Performed such other analyses, reviewed such other information, and considered such other factors as ValueScope has deemed appropriate.

#### *Assumptions*

ValueScope has not independently verified any of the foregoing information and has relied upon its completeness and accuracy in all material aspects. For purposes of rendering the Fairness Opinion, ValueScope has, with Summit's consent, relied upon and assumed the accuracy and completeness of all of the financial, legal, regulatory, tax, accounting and other information provided to, discussed with or reviewed by ValueScope, without assuming any responsibility for independent verification thereof. In that regard, ValueScope has assumed, with Summit's consent, that the forecasts and the projections have been reasonably prepared based on its independent judgment as well as adjustment of the estimates and assumptions provided by YS Biopharma's management. The projections only reflect their estimates based on currently available information and assumptions as of the Valuation Date. However, current information and assumptions provided by YS Biopharma's management pertaining to YS Biopharma's general business, economic, market, COVID-19 and financial conditions and various other factors, such as the clinical study outcome, regulatory pathway, success and timeline of the applicable product or product candidate, are subjective in many respects and are difficult to predict and are beyond YS Biopharma's control. ValueScope has not made an independent evaluation or appraisal of the assets and liabilities.

ValueScope further (i) assumes that, as of the Valuation Date, YS Biopharma and its assets will continue to operate as configured as a going concern, (ii) is based on the past, present and future projected financial condition of YS Biopharma and its assets as of the Valuation Date, (iii) assumes that YS Biopharma has no undisclosed real or contingent assets or liabilities, other than in the ordinary course of business, that would have a material effect on the analysis of ValueScope, and (iv) understands that the financial valuation and

projections are subjective in many respects and thus are susceptible to multiple interpretations and periodic revisions based on actual experience and business developments.

ValueScope further assumes that YS Biopharma will be competently managed and maintained over the expected period of ownership. The Fairness Opinion does not entail an evaluation of YS Biopharma management's effectiveness.

#### ***Conditions and Work Scope***

The Fairness Opinion does not address the underlying business decision of Summit to engage in the Business Combination, or the relative merits of the Business Combination compared to any strategic alternatives that may be available to Summit, nor does it address any legal, regulatory, tax or accounting matters. The Fairness Opinion addresses only the fairness of the Business Combination from a financial point of view to the shareholders of Summit.

ValueScope is not acting as the financial advisor to Summit or its shareholders in connection with the Business Combination and was engaged solely to conduct the Fairness Opinion.

#### ***Valuation Analysis***

The following summary of the valuation analysis included in this proxy statement/prospectus is summary of valuation analysis prepared by ValueScope in connection with their presentation of the Fairness Opinion described in the section entitled "— Summary of Valuation Analysis and Opinion of Financial Advisor to the Summit Board", rather than being included to influence your decision whether to vote for the Business Combination.

The valuation analyses reviewed by Summit Board were conducted based upon numerous material assumptions, many of which are beyond the control of Summit, YS Group or any other parties to the Business Combination. The valuation analysis is subjective in many respects and is based on the information and estimates as of the relevant valuation date, and therefore susceptible to varying interpretations and the need for periodic revision based on actual experience and business developments, and is not intended for third-party use, including by investors or holders. Any estimates contained in these analyses are not necessarily indicative of actual values or predictive of future results or values, which may be significantly more or less favorable than as set forth below. In addition, analyses relating to the value of YS Group do not purport to be appraisals or reflect the prices at which YS Biopharma's shares may actually be valued or trade in the open market after the consummation of the Business Combination. Accordingly, the assumptions and estimates used in, and the results derived from, the financial analysis are inherently subject to substantial uncertainty.

In preparing the Fairness Opinion, ValueScope performed a variety of analyses, including those described below. The summary of ValueScope's analyses is not a complete description of the analyses underlying the Fairness Opinion. The preparation of such an opinion is a complex process involving various quantitative and qualitative judgments and determinations with respect to the financial, comparative and other analytical methods employed and the adaptation and application of these methods to the unique facts and circumstances presented. As a consequence, neither the Fairness Opinion nor its underlying analyses is readily susceptible to summary description. ValueScope arrived at its opinion based on the results of all analyses undertaken by it and assessed as a whole and did not draw, in isolation, conclusions from or with regard to any individual analysis, methodology or factor. While the results of each analysis were taken into account in reaching ValueScope's overall conclusion with respect to fairness, ValueScope did not make separate or quantifiable judgments regarding individual analyses. Accordingly, ValueScope believes that its analyses and the following summary must be considered as a whole and that selecting portions of its analyses, methodologies and factors, without considering all analyses, methodologies and factors, could create a misleading or incomplete view of the processes underlying ValueScope's analyses and opinion.

The income and market approaches are most appropriate when conducting a valuation of a going-concern. Due to the stage of YS Biopharma and reliance on future cash flows from new products, the market approach would not provide a meaningful estimate of value. Therefore, ValueScope relied on the income approach.

### *Income Approach*

The income approach quantifies the present value of anticipated future income generated by a business or an asset. Forecasts of future income require analyses of variables that influence income, such as revenues, expenses, and taxes. One form of the income approach, the discounted cash flow (DCF) method, defines future economic income as net cash flow and considers not only the profit-generating abilities of a business but also the investment in capital equipment and working capital required to sustain the projected net cash flow. The forecasted net cash flow is then discounted to present value using an appropriate rate of return or discount rate. The income approach is unique in its ability to account for the specific contribution to the overall value of various factors of production.

ValueScope reviewed the products and markets and implied market share, as well as the product development stages to forecast the timing and amounts of future revenues. ValueScope then projected the estimated cost of sales, operating expenses and other factors to forecast future cash flows to the business. The future cash flows were then discounted at an appropriate discount rate, given the timing, uncertainty and risk of achieving the future cash flows.

### *Projected Information*

The summary of the projections included in this proxy statement/prospectus is included solely because such projections were made available by ValueScope to the Summit Board in connection with their presentation of the Fairness Opinion described in the section entitled “— Summary of Valuation Analysis and Opinion of Financial Advisor to the Summit Board,” rather than being included to influence your decision whether to vote for the Business Combination.

The summary set forth below does not purport to be a complete description of the financial analyses reviewed or factors considered by Summit Board, nor does the order of the financial analyses described represent the relative importance or weight given to those financial analyses by the Summit Board. Summit Board may have deemed various assumptions more or less probable than other assumptions. Some of the summaries of the financial analyses set forth below include information presented in tabular format. Considering the data in the tables specified below without considering all financial analyses or factors or the full narrative description of such analyses or factors, including the methodologies and assumptions underlying such analyses or factors, could create a misleading or incomplete view of the processes underlying ValueScope’s financial analyses and the recommendation of Summit Board.

The summary financial projections prepared by ValueScope in connection with the Fairness Opinion are presented in the table below:

(RMB in million)	For the Projected Fiscal Year Ended March 31,									
	2023E	2024E	2025E	2026E	2027E	2028E	2029E	2030E	2031E	2032E
Revenue*	755	1,074	2,063	2,223	2,520	2,886	3,531	3,931	4,335	4,483
Cost of Goods Sold	136	172	421	472	535	564	512	535	578	560
<b>Gross Profit</b>	<b>619</b>	<b>902</b>	<b>1,642</b>	<b>1,751</b>	<b>1,985</b>	<b>2,322</b>	<b>3,019</b>	<b>3,396</b>	<b>3,777</b>	<b>3,923</b>
Operating Expenses	666	802	726	714	773	856	1,029	1,147	1,267	1,312
<b>EBITDA</b>	<b>(46)</b>	<b>100</b>	<b>916</b>	<b>1,037</b>	<b>1,212</b>	<b>1,466</b>	<b>1,991</b>	<b>2,249</b>	<b>2,510</b>	<b>2,611</b>
Depreciation & amortization expense	30	31	32	32	33	34	35	36	37	38
<b>EBIT</b>	<b>77</b>	<b>69</b>	<b>884</b>	<b>1,005</b>	<b>1,179</b>	<b>1,433</b>	<b>1,956</b>	<b>2,214</b>	<b>2,474</b>	<b>2,574</b>
Income Tax	—	—	96	147	174	215	293	332	371	386
<b>Net Income</b>	<b>(76)</b>	<b>69</b>	<b>788</b>	<b>858</b>	<b>1,005</b>	<b>1,218</b>	<b>1,662</b>	<b>1,882</b>	<b>2,102</b>	<b>2,187</b>

\* Revenue projections were based on the estimates of YSJA rabies vaccine PIKA rabies vaccines and PIKA recombinant COVID-19 vaccine, which have taken into consideration of the clinical status of the applicable product or product candidate as well as the expected clinical and regulatory approval pathway and timeline.

The above projections reflect numerous estimates and assumptions over the projection period with respect to general business, economic, regulatory, market and financial conditions and other future events, as well as

matters specific to YS Biopharma's business, capturing YSJA rabies vaccine, PIKA rabies vaccines, and PIKA recombinant COVID-19 vaccine during the projection period.

The financial projections included in this proxy statement/prospectus have been prepared by ValueScope based on its independent judgment as well as adjustment of the estimates and assumptions provided by YS Biopharma's management. The projections only reflect their estimates based on currently available information and assumptions as of the Valuation Date. However, current information and assumptions provided by YS Biopharma's management pertaining to YS Biopharma's general business, economic, market, COVID-19 and financial conditions and various other factors, such as the clinical study outcome, regulatory pathway, success and timeline of the applicable product or product candidate, are subjective in many respects and are difficult to predict and are beyond YS Biopharma's control.

ValueScope independently reviewed and analyzed certain assumptions provided by YS Biopharma's management, which include, among other things, (i) the clinical development timeline of the applicable product or product candidate as well as the expected clinical and regulatory approval pathway; (ii) the susceptible population; (iii) estimated market shares for the applicable product or product candidates; and (iv) the estimated production capability with respect to the applicable product or product candidates. ValueScope reviewed and adjusted certain assumptions provided by YS BioPharma's management, which include, among other things, the adjustments and assumptions discussed below.

ValueScope adjusted the potential launch dates for PIKA rabies vaccine, PIKA recombinant COVID-19 vaccine and adjusted the projected market share ramp up time accordingly, which effectively affected ValueScope's revenue, income and profitability projections. In regard to potential launch dates, ValueScope assumed that (a) PIKA rabies vaccine would launch in March 2025 and March 2027, in Southeast Asia and China, respectively, and (b) PIKA recombinant COVID-19 vaccine would launch in March 2025 in China and ex-China. In regards to market share ramp up, ValueScope further assumed that: (i) the market share penetration for YSJA (YS Biopharma's launched product) would be 14.0% in the first year, 19.3% in second year, 13.2% in the third year, 9.2% in the fourth year, 6.2% in the fifth year, 4.3% in the sixth year, 4.0% in the seventh year, 3.8% in the eighth year, 3.6% in the ninth year, and 3.4% in the tenth year, in each case following the assumed product launch date; (ii) the market share penetration in China for PIKA rabies vaccine would be 1.0% in the first year, 3.5% in the second year, 7.5% in the third year, 10.0% in the fourth year, 12.5% in the fifth year, and 13.5% in sixth year, in each case following the assumed product launch date in China; (iii) the market share penetration in Southeast Asia for PIKA rabies vaccine would be 5.0% from the first through the eighth year following the assumed product launch date in Southeast Asia; (iv) the market share penetration in China for PIKA recombinant COVID-19 vaccine would be 2.0% in the first year, 7.0% in the second year, 8.0% in the third year, 8.2% in the fourth year, 8.3% in the fifth through the eighth year, in each case following the assumed product launch date in China; and (v) the market share penetration in ex-China for PIKA recombinant COVID-19 vaccine would be 2.5% in the first year, 3.2% in the second year, 3.7% in the third through the eighth year, in each case following the assumed product launch date ex-China.

In addition, based on review of industry data and the profitability of the industry peers, ValueScope revised the projected gross margins and EBITDA margins, such as the revision of the EBITDA margins to the range between -6.1% and 58.2% from the range between 3% and 67% as estimated by YS Biopharma's management. ValueScope also conducted comparable company analysis based on industry research and review of the six publicly traded companies on the Shanghai Stock Exchange which operated in the biopharmaceutical product development industry. These companies have similar suppliers and customers, and face certain similar business and economic risks to the Company. For more details regarding the comparable companies, see the section entitled "— Comparable Company Analysis" below.

YS Biopharma does not, as a matter of general practice, publicly disclose forecasts or internal projections of future performance, revenue, financial condition or other results. Neither the inputs or assumptions provided by YS Biopharma to ValueScope nor projections made by ValueScope were prepared with a view toward public disclosure, or with a view toward complying with the published guidelines of the SEC regarding projections or the guidelines established by the American Institute of Certified Public Accountants for preparation and presentation of prospective financial information.

In addition, the inclusion of projections in this proxy statement/prospectus should not be regarded as an indication that Summit, the Summit Board, or their respective affiliates, advisors, representatives, or any other

recipient of this information, considered, or now considers, such financial projections to be fact or necessarily to be predictive of actual future results, and these projections should not be relied upon as such. You are cautioned not to place undue reliance on the projections in making a decision regarding the Business Combination. We will not refer back to the above projections in our future periodic reports filed under the Exchange Act.

The financial projections are forward-looking statements that are inherently subject to significant uncertainties and contingencies, many of which are beyond the control of, YS Biopharma, Summit, and ValueScope. The various risks and uncertainties include those set forth in the sections entitled “Risk Factors,” “YS Biopharma’s Management’s Discussion and Analysis of Financial Condition and Results of Operations” and “Cautionary Note Regarding Forward-Looking Statements,” and the projections may be impacted by factors including, without limitation, YS Group’s ability to successfully compete in highly competitive industries and markets, the overall economic environment and general market and economic conditions in the jurisdictions in which YS Group operations, YS Group’s ability to execute its strategies, manage growth and maintain its corporate culture as it grows. As a result, there can be no assurance that the projected results will be realized or that actual results will not be significantly higher or lower than projected. Since the financial projections cover multiple years, such information by its nature becomes less reliable with each successive year and should be read in that context.

These financial projections are subjective in many respects and thus are susceptible to multiple interpretations and periodic revisions based on actual experience and business developments. In light of the foregoing factors and the uncertainties inherent in these financial projections, shareholders are cautioned not to place undue reliance on the projections.

Neither Wei, Wei & Co., LLP nor WithumSmith+Brown, PC or any other independent accountant has audited, reviewed, examined, compiled nor applied agreed-upon procedures with respect to the financial projections contained herein and accordingly, neither Wei, Wei & Co., LLP nor WithumSmith+Brown, PC or any other independent accountant expresses any opinion or any other form of assurance on such information or its achievability, and assume no responsibility for, and disclaim any association with, the financial projections. The WithumSmith+Brown, PC report included in this proxy statement/prospectus relates to Summit’s historical financial statements. Wei, Wei & Co., LLP reports included in this proxy statement/prospectus relate to YS Biopharma’s historical financial statements. Such reports do not extend to the financial projections and should not be read to do so.

#### *Comparable Company Analysis*

In conducting comparable company analysis, ValueScope identified six publicly traded companies on the Shanghai Stock Exchange and operated in the biopharmaceutical product development industry. These companies have similar suppliers and customers, and face certain similar business and economic risks to YS Biopharma. The comparable companies selected by ValueScope are set forth below:

1. Chongqing Zhifei Biological Products Co., Ltd.
2. Beijing Wantai Biological Pharmacy Enterprise Co., Ltd.
3. Hualan Biological Engineering Inc.
4. Shenzhen Kangtai Biological Products Co., Ltd.
5. Walvax Biotechnology Co., Ltd.
6. Chengdu Kanghua Biological Products Co., Ltd.

The following table details the key data required for the cost of capital expectations for each of the comparable companies.



Ticker	Company Name	Historical Beta	Shares Outstanding	Share Price	Market Cap	Debt, Pref. & Min Int.	Avg. Debt / Equity	Debt / Total Cap	Effective Tax Rate	Unlevered Beta
SZSE:300122	Chongqing Zhifei Biological Products Co., Ltd.	0.53	1,600,000	RMB16.57	RMB26,512,624	RMB2,414,425	9.1%	8.3%	14.1%	0.50
SHSE:603392	Beijing Wantai Biological Pharmacy Enterprise Co., Ltd.	0.51	880,208	RMB23.18	RMB20,404,568	RMB488,319	2.4%	2.3%	10.9%	0.50
SZSE:002007	Hualan Biological Engineering Inc.	0.43	1,824,367	RMB3.40	RMB6,208,940	RMB2,666,743	43.0%	30.0%	14.6%	0.32
SZSE:300601	Shenzhen Kangtai Biological Products Co., Ltd.	0.45	1,120,487	RMB6.74	RMB7,556,554	RMB2,426,448	32.1%	24.3%	11.4%	0.35
SZSE:300142	Walvax Biotechnology Co., Ltd.	0.38	1,601,572	RMB7.22	RMB11,568,378	RMB2,196,870	19.0%	16.0%	21.5%	0.33
SZSE:300841	Chengdu Kanghua Biological Products Co., Ltd.	1.52	134,592	RMB17.23	RMB2,319,242	RMB40,755	1.8%	1.7%	9.7%	1.50
	<b>Median</b>				<b>RMB9,562,466</b>		<b>14.0%</b>			<b>0.42</b>

Due to the early-stage status and the large number of product candidates in YS Biopharma's pipeline, as compared to the comparable companies, ValueScope is of the view that comparable company analysis is not a suitable approach to assess the valuation of YS Group. As a result, ValueScope did not conduct any valuation on YS Biopharma using comparable companies analysis. The comparable company analysis was performed by ValueScope only to review certain key data and inputs necessary to estimate YS Biopharma's cost of capital as well as to assess YS Biopharma operating performance outlook relative to the industry to test the reasonability of the projected financials statements. In particular, ValueScope used the comparable company analysis to determine the WACC for the discount rate in its DCF model, and beta.

NONE OF SUMMIT AND YS BIOPHARMA HAS WARRANTED THE ACCURACY, RELIABILITY, APPROPRIATENESS OR COMPLETENESS OF THE PROJECTIONS TO ANYONE. NONE OF THEM OR ANY OF THEIR RESPECTIVE MANAGEMENT OR REPRESENTATIVES HAS MADE OR MAKES ANY REPRESENTATION TO ANY PERSON REGARDING THE ULTIMATE PERFORMANCE OF YS BIOPHARMA COMPARED TO THE INFORMATION CONTAINED IN THE PROJECTIONS, AND, EXCEPT TO THE EXTENT REQUIRED BY LAW, NONE OF THEM INTENDS TO OR UNDERTAKES ANY OBLIGATION TO UPDATE OR OTHERWISE REVISE THE PROJECTIONS TO REFLECT CIRCUMSTANCES EXISTING AFTER THE DATE WHEN MADE OR TO REFLECT THE OCCURRENCE OF FUTURE EVENTS IN THE EVENT THAT ANY OR ALL OF THE ASSUMPTIONS UNDERLYING THE PROJECTIONS ARE SHOWN TO BE IN ERROR. ACCORDINGLY, THEY SHOULD NOT BE LOOKED UPON AS "GUIDANCE" OF ANY SORT. SUMMIT WILL NOT REFER BACK TO THE PROJECTIONS IN FUTURE PERIODIC REPORTS FILED UNDER THE EXCHANGE ACT FOLLOWING THE BUSINESS COMBINATION. NONE OF SUMMIT, YS BIOPHARMA OR ANY OTHER PERSON ASSUMES RESPONSIBILITY IF FUTURE RESULTS ARE MATERIALLY DIFFERENT FROM THOSE DISCUSSED.

THE PROJECTIONS ARE NOT INCLUDED IN THIS PROXY STATEMENT/PROSPECTUS AS AN INDICATION THAT SUMMIT OR YS BIOPHARMA CONSIDERS SUCH PROJECTIONS AND ANALYSIS TO BE FACT OR NECESSARY TO BE PREDICATIVE OF ACTUAL FUTURE RESULTS. IT IS ALSO NOT INCLUDED IN ORDER TO INDUCE ANY SUMMIT SHAREHOLDERS TO VOTE IN FAVOR OF OR AGAINST THE BUSINESS COMBINATION. YOU ARE CAUTIONED NOT TO PLACE UNDUE RELIANCE ON THE PROJECTIONS IN MAKING A DECISION REGARDING THE BUSINESS COMBINATION AS THE PROJECTIONS MAY BE MATERIALLY DIFFERENT THAN ACTUAL RESULTS.

EXCEPT TO THE EXTENT REQUIRED BY APPLICABLE FEDERAL SECURITIES LAWS, BY INCLUDING IN THIS PROXY STATEMENT/PROSPECTUS A SUMMARY OF THE FINANCIAL PROJECTIONS FOR YS BIOPHARMA, NONE OF SUMMIT AND YS BIOPHARMA UNDERTAKES ANY OBLIGATIONS AND EXPRESSLY DISCLAIMS ANY RESPONSIBILITY TO UPDATE OR REVISE, OR PUBLICLY DISCLOSE ANY UPDATE OR REVISION TO, THESE FINANCIAL PROJECTIONS TO REFLECT CIRCUMSTANCES OR EVENTS, INCLUDING UNANTICIPATED

EVENTS, THAT MAY HAVE OCCURRED OR THAT MAY OCCUR AFTER THE PREPARATION OF THESE FINANCIAL PROJECTIONS, EVEN IN THE EVENT THAT ANY OR ALL OF THE ASSUMPTIONS UNDERLYING THE FINANCIAL PROJECTIONS ARE SHOWN TO BE IN ERROR OR CHANGE.

### **Conclusion**

ValueScope's estimate indicated that the total consideration to be paid by Summit in the Business Combination is **FAIR**, from a financial point of view, to the shareholders of Summit as a group (as opposed to only the shareholders unaffiliated with the Sponsor or its affiliates).

### **Miscellaneous**

ValueScope received customary fees from Summit for its services, in the amount of \$90,000, \$45,000 of which was paid upon Summit's retention, and the additional \$45,000 was paid subsequent to ValueScope's issuance of the draft fairness opinion and prior to the issuance of the final version of the fairness opinion. No portion of ValueScope's fee was contingent upon the conclusion reached in its opinion. Other than being engaged as an independent financial advisor to conduct a fairness analysis in connection with the proposed Business Combination, ValueScope and its affiliates have not provided any additional services in connection with the proposed Business Combination or otherwise to Summit, YS Biopharma or their respective affiliates.

### **Additional Comparable Companies**

The following summary of the additional comparable companies is included in this proxy statement/prospectus solely because such information was made available publicly by YS Biopharma's management in connection with the Business Combination. The following information was included for reference and information only and was not presented to ValueScope for purposes of their analysis or preparation of the Fairness Opinion, nor was such information presented to or reviewed by the Summit Board for their assessment of the valuation of YS Group or consideration of the Business Combination.

The comparable companies selected by YS Biopharma's management included (i) three companies publicly traded on the Shanghai Stock Exchange, namely Walvax Biotechnology Co., Ltd., Beijing Wantai Biological Pharmacy Enterprise Co., Ltd. and Shenzhen Kangtai Biological Products Co., Ltd. and (ii) one company publicly traded on the Hong Kong Stock Exchange, namely CanSino Biologics Inc. These companies were selected because YS Biopharma considered them as comparable biopharmaceutical companies.

The table below set forth the estimated revenue multiple based on publicly available market data as of September 9, 2022.

	<b>2023E Revenue Multiples</b>	<b>2024E Revenue Multiples</b>
CanSino Biologics	8.6x	6.7x
Walvax Biotechnology	8.5x	6.9x
Wantai BioPharm	8.3x	7.0x
Shenzhen Kangtai Biological Products	6.3x	5.0x
<b>Average</b>	<b>7.9x</b>	<b>6.4x</b>

### **Satisfaction of 80% Test**

After consideration of the factors identified and discussed in the section entitled "The Business Combination Proposal — Reasons for Summit Board's Approval of the Business Combination," the Summit Board concluded that the Business Combination met the requirements disclosed in the prospectus of the IPO with respect to Summit's initial business combination, including that the Business Combination had a fair market value of at least 80% of the balance of the funds in the Trust Account at the time of execution of the Business Combination Agreement.

### Interests of Summit's Directors, Officers and the Sponsor in the Business Combination

When considering the Summit Board's recommendation to vote in favor of approving the Business Combination Proposal and the Merger Proposal, Summit shareholders should keep in mind that Sponsor and Summit's directors and officer have interests in such proposals that are different from, or in addition to (and which may conflict with), those of Summit shareholders and warrant holders generally.

These interests include, among other things, the interests listed below:

- the fact that the Sponsor and Summit's directors and officers have agreed to waive their redemption rights with respect to their Summit Class B Ordinary Shares in connection with the completion of the proposed Business Combination;
- the fact that the Sponsor and certain of Summit's directors are anticipated to hold 3.46% of the equity interest and 3.46% of the voting power in YS Biopharma immediately after the Business Combination, assuming no redemptions by Summit Public Shareholders and there are no Dissenting Summit Shareholders (or 4.26% of the equity interest and 4.26% of the voting power in YS Biopharma immediately after the Business Combination, assuming 100% redemption by Summit Public Shareholders);
- the fact that the Sponsor paid an aggregate of \$25,000 for the 5,750,000 Summit Class B Ordinary Shares currently owned by the Sponsor, Summit's directors and Forward Purchase Investors and such securities will have a significantly higher value after the Business Combination. As of February 2, 2023, the most recent practicable date prior to the date of this proxy statement/prospectus, the aggregate market value of these shares, if unrestricted and freely tradable, would be \$58,190,000, based upon a closing price of \$10.12 per Summit Class A Ordinary Share on Nasdaq. The Summit Class B Ordinary Shares are expected to be worthless if the Business Combination or another business combination is not completed by the Final Redemption Date because the holders are not entitled to participate in any redemption or distribution of proceeds in the Trust Account with respect to such shares;
- the fact that Sponsor paid \$6,000,000 to purchase an aggregate of 6,000,000 Summit Private Warrants, each exercisable to purchase one Summit Class A Ordinary Share at \$11.50, subject to adjustment, at a price of \$1.00 per warrant, and those warrants would be worthless — and the entire \$6,000,000 warrant investment would be lost — if the Business Combination or another business combination is not consummated by the Final Redemption Date. As of February 2, 2023, the most recent practicable date prior to the date of this proxy statement/prospectus, the aggregate market value of these Summit Private Warrants, if unrestricted and freely tradable, would be \$1,664,400, based upon a closing price of \$0.2774 per Summit Public Warrant on Nasdaq;
- the fact that, given the differential in the purchase price that the Sponsor paid for the Summit Class B Ordinary Shares and the purchase price that the Sponsor paid for the Summit Private Warrants as compared to the price of the Summit Class A Ordinary Shares and Summit Public Warrants and the substantial number of YS Biopharma Ordinary Shares that the Sponsor and these directors will receive upon conversion of the Summit Class B Ordinary Shares and Summit Private Warrants, the Sponsor and these directors can earn a positive return on their investment, even if other Summit shareholders have a negative return in their investment in YS Biopharma;
- the fact that Sponsor and Summit's directors and officers have agreed to waive their rights to liquidating distributions from the Trust Account with respect to any Summit Class B Ordinary Shares held by them if Summit fails to complete a business combination by the Final Redemption Date;
- the fact that the Business Combination Agreement provides for continued indemnification of Summit's directors and officers and the continuation of Summit's directors' and officers' liability insurance after the Business Combination (i.e., a "tail policy");
- the fact that Sponsor and Summit's directors and officers and their affiliates are entitled to reimbursement of out-of-pocket expenses incurred by them in connection with certain activities on Summit's behalf, such as identifying and investigating possible business targets and business combinations. However, if Summit fails to consummate a business combination within the required period, they will not have any claim against the Trust Account for reimbursement. Accordingly, Summit may not be able to reimburse these expenses if the Business Combination or another business combination is not completed by the Final Redemption

Date. That being said, the Sponsor and Summit's directors and officers and their affiliates had not incurred any unpaid reimbursable expenses as of the date of this proxy statement/prospectus;

- the fact that the Sponsor will benefit from the completion of a business combination and may be incentivized to complete an acquisition of a less favorable target company or on terms less favorable to shareholders rather than liquidate;
- the fact that if the Trust Account is liquidated, including in the event Summit is unable to complete a business combination by the Final Redemption Date, the Sponsor has agreed to indemnify Summit to ensure that the proceeds in the Trust Account are not reduced below \$10.00 per Summit Class A Ordinary Share, or such lesser per Summit Class A Ordinary Share amount as is in the Trust Account on the liquidation date, by the claims of prospective target businesses with which Summit has discussed entering into a transaction agreement or claims of any third party for services rendered or products sold to Summit (other than Summit's independent registered public accounting firm), but only if such a vendor or target business has not executed a waiver of any and all rights to seek access to the Trust Account;
- the fact that the Summit Articles contain a waiver of the corporate opportunity doctrine. With such waiver, there could be business combination targets that maybe suitable or worth consideration for a combination with Summit but not offered due to a Summit director's duties to another entity. Summit does not believe that the potential conflict of interest relating to the waiver of the corporate opportunities doctrine in the Summit Articles impacted its search for an acquisition target and Summit was not prevented from reviewing any opportunities as a result of such waiver;
- the fact that HK Yisheng, a subsidiary of YS Biopharma, entered into the Facility Agreement with, among other parties, R-Bridge, as the original lender. R-Bridge is 100% owned by R-Bridge Fund. Mr. Wei Fu, the Honorary Chairman and Senior Advisor of Summit and one of the managers of the Sponsor, is the sole director of R-Bridge and one of the investment committee members of R-Bridge Fund. Pursuant to the Facility Agreement, (i) R-Bridge made available to YS Biopharma a term loan facility in an aggregate amount of \$40,000,000, all of which was outstanding as of the date hereof, (ii) the facility and commitment under the Facility Agreement will be immediately cancelled and all of the outstanding loans, together with accrued interest and other amounts will become immediately due and payable if a listing, admission to trading, flotation or public offering of any shares of YS Biopharma (including upon or as a result of any direct or indirect merger, consolidation or takeover) has not occurred by October 31, 2023 or a later day as determined under the Facility Agreement; and (iii) consents from the lender(s) whose commitments aggregate more than 2/3 of the total amount then outstanding are required to approve certain transactions, including the Business Combination Agreement; and
- the fact that Mr. Bo Tan, a current director of Summit, is expected to become a director of YS Biopharma and in such case would be compensated as a director of YS Biopharma.

#### **Anticipated Accounting Treatment of the Business Combination**

Notwithstanding the legal form of the Business Combination pursuant to the Business Combination Agreement, the Business Combination will be accounted as recapitalization. Summit will be treated as the "acquired" company and YS Biopharma will be treated as the acquirer for financial statement reporting purposes. YS Biopharma has been determined to be the accounting acquirer based on evaluation of the following facts and circumstances:

- YS Biopharma's shareholders will have the largest voting interest in the post-combination company under both the no redemption and 100% redemption scenarios;
- YS Biopharma's shareholders will have the ability to nominate at least a majority of the members of the board of directors of the post-combination company;
- YS Biopharma's senior management is the senior management of the post-combination company; and
- YS Biopharma is the larger entity, in terms of YS Biopharma's substantive operations and employee base.

#### **Regulatory Matters**

The Business Combination Agreement and the transactions contemplated by the Business Combination Agreement are not subject as a closing condition to any additional federal, state or foreign regulatory

requirement or approval, except for filings and registration with the Registrar of Companies of the Cayman Islands and the payment of the applicable fees under the Cayman Islands Companies Act necessary to effectuate the Mergers contemplated by the Business Combination Agreement.

#### **Appraisal or Dissenters' Rights**

Holders of record of Summit Shares may have appraisal rights in connection with the Business Combination under the Cayman Islands Companies Act. In this proxy statement/prospectus, these appraisal or dissent rights are sometimes referred to as "Dissent Rights". Holders of record of Summit Shares wishing to exercise such Dissent Rights and make a demand for payment of the fair value for his, her or its Summit Shares must give written objection to the First Merger to Summit prior to the shareholder vote at the Extraordinary General Meeting to approve the First Merger and follow the procedures set out in Section 238 of the Cayman Islands Companies Act, noting that any such dissenter rights may subsequently be lost and extinguished pursuant to Section 239 of the Cayman Islands Companies Act which states that no such dissenter rights shall be available in respect of shares of any class for which an open market exists on a recognized stock exchange or recognized interdealer quotation system at the expiry date of the period allowed for written notice of an election to dissent provided that the merger consideration constitutes inter alia shares of any company which at the effective date of the merger are listed on a national securities exchange. The Business Combination Agreement provides that, if any Summit shareholder exercises Dissent Rights then, unless Summit and YS Biopharma elect by agreement in writing otherwise, the Mergers shall not be consummated before the expiry date of the period allowed for written notice of an election to dissent in order to invoke the exemption under Section 239 of the Cayman Islands Companies Act. Summit believes that such fair value would equal the amount that Summit shareholders would obtain if they exercised their redemption rights as described herein. A Summit shareholder which elects to exercise Dissent Rights must do so in respect of all of the Summit Shares that person holds and will lose their right to exercise their redemption rights as described herein. See the section entitled "Extraordinary General Meeting of Summit Shareholders — Appraisal Rights under the Cayman Islands Companies Act."

Holders of Summit Shares are recommended to seek their own advice as soon as possible on the application and procedure to be followed in respect of the appraisal rights under the Cayman Islands Companies Act.

#### **Resolution to be Voted Upon**

The full text of the resolution to be proposed is as follows:

**"RESOLVED**, as an ordinary resolution, that Summit Healthcare Acquisition Corp. ("Summit")'s entry into the Business Combination Agreement, dated as of September 29, 2022, by and among Summit, YishengBio Co., Ltd. (to be renamed as YS Biopharma Co., Ltd., herein referred to as "YS Biopharma"), Oceanview Bioscience Acquisition Co., Ltd. ("Merger Sub I") and Hudson Biomedical Group Co., Ltd. ("Merger Sub II"), a copy of which is included as **Annex A** to the accompanying proxy statement/prospectus, pursuant to which, among other things, Merger Sub I will merge with and into Summit, with Summit surviving the merger as the surviving entity (the "Surviving Entity") and becoming a wholly-owned subsidiary of YS Biopharma, and immediately thereafter and as part of the same overall transaction, the Surviving Entity will merge with and into Merger Sub II, with Merger Sub II surviving the merger as the surviving entity (the "Surviving Company") and remaining a wholly-owned subsidiary of YS Biopharma, which will become the parent/public company following the Business Combination, in accordance with the terms and subject to the conditions of the Business Combination Agreement, and the transactions contemplated thereby be approved, ratified and confirmed in all respects."

#### **Votes Required for Approval**

The approval of the Business Combination Proposal will require an ordinary resolution under Cayman Islands law and the Summit Articles, being the affirmative vote of the holders of a majority of the issued and outstanding Summit Shares present in person physically or by virtual attendance or represented by proxy and entitled to vote at the Extraordinary General Meeting.

The approval of the Business Combination Proposal is a condition to the consummation of the Business Combination. If the Business Combination Proposal is not approved, the other proposals (except the Adjournment Proposal, as described below) shall not be presented to the holders of Summit Shares for a vote.

An abstention or broker non-vote will be counted towards the quorum requirement but will not count as a vote cast at the Extraordinary General Meeting.

**Recommendation of Summit Board**

**THE SUMMIT BOARD OF DIRECTORS UNANIMOUSLY RECOMMENDS THAT THE HOLDERS OF SUMMIT SHARES VOTE “FOR” THE APPROVAL OF THE BUSINESS COMBINATION PROPOSAL.**

**PROPOSAL NO. 2 — THE MERGER PROPOSAL****General**

Holders of Summit Shares are being asked to authorize the Merger and the Plan of First Merger.

A copy of the Plan of First Merger is attached as Exhibit C-1 to the Business Combination Agreement.

**Resolutions to be Voted Upon**

The full text of the resolution to be proposed is as follows:

**“RESOLVED**, as a special resolution that the First Merger and the Plan of First Merger, a copy of which is included as **Annex C** to the accompanying proxy statement/prospectus, and any and all transactions provided for in the First Plan of Merger, including, without limitation (a) the First Merger; (b) at the effective time of the First Merger (the “First Merger Effective Time”), the amendment and restatement of the Summit Articles by deletion in their entirety and the substitution in their place of the amended and restated memorandum and articles of association of Summit (as the Surviving Entity) in the form attached as Annex 2 to the Plan of First Merger (the “Surviving Entity Articles”), being the memorandum and articles of association of Merger Sub I; and (c) at the First Merger Effective Time, the redesignation of all authorized class A ordinary shares of \$0.0001 par value per share and class B ordinary shares of \$0.0001 par value per share of the Surviving Entity as ordinary shares of \$0.0001 par value per share, such that the authorized share capital of the Surviving Entity will become \$45,500 divided into 455,000,000 ordinary shares of a par value of \$0.0001 per share, with such rights, privileges and conditions as set out in the Surviving Entity Articles be approved and authorized in all respects.”

**Votes Required for Approval**

The approval of the Merger Proposal will require a special resolution under Cayman Islands law and the Summit Articles, being the affirmative vote of the holders of at least two-thirds of the issued and outstanding Summit Shares present in person physically or by virtual attendance or represented by proxy and entitled to vote at the Extraordinary General Meeting.

An abstention or broker non-vote will be counted towards the quorum requirement but will not count as a vote cast at the Extraordinary General Meeting.

**Recommendation of Summit Board**

**THE SUMMIT BOARD OF DIRECTORS UNANIMOUSLY RECOMMENDS THAT THE SUMMIT SHAREHOLDERS VOTE “FOR” THE APPROVAL OF THE MERGER PROPOSAL.**

## PROPOSAL NO. 3 — THE ADJOURNMENT PROPOSAL

### General

Holders of Summit Shares are being asked to adopt the Adjournment Proposal, if presented.

The Adjournment Proposal, if adopted, shall allow the chairman of the Extraordinary General Meeting to adjourn the Extraordinary General Meeting to a later date or dates, if necessary. In no event shall Summit solicit proxies to adjourn the Extraordinary General Meeting or consummate the Business Combination beyond the date by which it may properly do so under the Summit Articles and the Cayman Islands Companies Act. The purpose of the adjournment proposal is to provide more time to meet the requirements that are necessary to consummate the Business Combination. See the section titled “The Business Combination Proposal—Interests of Summit’s Directors, Officers and the Sponsor in the Business Combination.”

### Consequences If the Adjournment Proposal Is Not Approved

If the Adjournment Proposal is presented to the meeting and is not approved by the shareholders, the Summit Board may not be able to adjourn the Extraordinary General Meeting to a later date or dates. In such event, the Business Combination would not be completed.

### Resolution to be Voted Upon

The full text of the resolution to be proposed is as follows:

“**RESOLVED**, as an ordinary resolution, that the adjournment of the Extraordinary General Meeting to a later date or dates to be determined by the chairman of the Extraordinary General Meeting, if necessary, to permit further solicitation and vote of proxies in the event that there are insufficient votes for the approval of one or more proposals at the Extraordinary General Meeting or if shareholders have elected to redeem an amount of Class A ordinary shares such that the minimum available cash condition contained in the Business Combination Agreement, dated as of September 29, 2022, by and among Summit Healthcare Acquisition Corp., YishengBio Co., Ltd, Oceanview Bioscience Acquisition Co., Ltd. and Hudson Biomedical Group Co., Ltd. (as it may be amended, supplemented or otherwise modified from time to time) would not be satisfied, be and is hereby approved.”

### Votes Required for Approval

The approval of the Adjournment Proposal will require an ordinary resolution under Cayman Islands law and the Summit Articles, being the affirmative vote of the holders of a majority of the issued and outstanding Summit Shares present in person physically or by virtual attendance or represented by proxy and entitled to vote at the Extraordinary General Meeting.

An abstention or broker non-vote will be counted towards the quorum requirement but will not count as a vote cast at the Extraordinary General Meeting.

### Recommendation of Summit Board

**THE SUMMIT BOARD OF DIRECTORS UNANIMOUSLY RECOMMENDS THAT THE SUMMIT SHAREHOLDERS VOTE “FOR” THE APPROVAL OF THE ADJOURNMENT PROPOSAL.**



## INFORMATION RELATED TO SUMMIT

*Unless the context otherwise requires, all references in this section to the “Company,” “we,” “us,” “our” or “Summit” refer to Summit Healthcare Acquisition Corp. prior to the consummation of the Business Combination.*

### Introduction

Summit is a blank check company incorporated on December 20, 2020 as a Cayman Islands exempted company for the purpose of effecting a merger, share exchange, asset acquisition, share purchase, reorganization or similar business combination with one or more businesses or entities. We reviewed a number of opportunities to enter into a business combination with an operating business, and entered into the Business Combination Agreement on September 29, 2022, as further described in the section entitled “The Business Combination Proposal” in this proxy statement/prospectus. We intend to effectuate the Business Combination using cash from the proceeds of the IPO, the sale of the Summit Private Warrants and forward purchase securities. Based on our business activities, we are a “shell company,” as defined under the Exchange Act, because we have no operations and nominal assets consisting almost entirely of cash.

### IPO and Concurrent Private Placement

On June 11, 2021, we consummated the IPO of 20,000,000 Units, at a price of \$10.00 per Unit, generating gross proceeds of \$200,000,000, and a concurrent private placement with the Sponsor of 6,000,000 Summit Private Warrants at a price of \$1.00 per warrant, generating gross proceeds of \$6,000,000. Each Unit consists of one Summit Public Share and one-half of one redeemable Summit Public Warrant. A total of \$200,000,000 from the net proceeds of the sale of the Units in the IPO and the sale of the Summit Private Warrants was placed in a U.S.-based trust account (the “Trust Account”) with Continental Stock Transfer & Trust Company acting as trustee, and will be invested only in U.S. government treasury bills with a maturity of 185 days or less or in money market funds investing solely in U.S. Treasuries and meeting certain conditions under Rule 2a-7 under the Investment Company Act.

Except with respect to interest earned on the funds held in the Trust Account that may be released to us to pay our income taxes, if any, the Summit Articles and subject to the requirements of law and regulation, will provide that the proceeds from the IPO and the sale of the Summit Private Warrants held in the Trust Account will not be released from the Trust Account (1) to us, until the completion of the initial business combination, or (2) to Summit Public Shareholders until the earliest of: (i) the completion of an initial business combination, and then only in connection with those Summit Public Shares that such shareholders properly elected to redeem, (ii) the redemption of any Summit Public Shares properly tendered in connection with a shareholder vote to amend the Summit Articles, and (iii) the redemption of Summit Public Shares if we have not consummated a business combination within 24 months from the closing of the IPO, subject to applicable law.

We have 24 months from the closing of the IPO to complete the initial business combination (the “Combination Period”). However, if we are unable to complete the initial business combination within the Combination Period, we will (i) cease all operations except for the purpose of winding up, (ii) as promptly as reasonably possible but not more than ten business days thereafter, redeem the Summit Public Shares, at a per-share price, payable in cash, equal to the aggregate amount then on deposit in the Trust Account, including interest earned on the funds held in the Trust Account and not previously released to us to pay its income taxes, if any (less up to \$100,000 of interest to pay dissolution expenses), divided by the number of the then outstanding Summit Public Shares, which redemption will completely extinguish Summit Public Shareholders’ rights as shareholders (including the right to receive further liquidation distributions, if any), and (iii) as promptly as reasonably possible following such redemption, subject to the approval of our remaining shareholders and our board of directors, liquidate and dissolve, subject in each case to our obligations under Cayman Islands law to provide for claims of creditors and the requirements of other applicable law.

As of September 30, 2022, there was \$201,200,243 in investments and cash held in the Trust Account and \$70,097 of cash held outside the Trust Account. As of September 30, 2022, no funds had been withdrawn from the Trust Account to pay taxes.

### Effecting Our Business Combination

#### *Fair Market Value of YS Biopharma’s Business*

Our initial business combination must occur with one or more operating businesses or assets that together have an aggregate fair market value equal to at least 80% of the assets held in the Trust Account (excluding

taxes payable on the interest earned on the Trust Account) at the time of signing a definitive agreement to enter into a business combination. We will not complete a business combination unless the post-transaction company owns or acquires 50% or more of the outstanding voting securities of the target or otherwise acquires a controlling interest in the target business sufficient for it not to be required to register as an investment company under the Investment Company Act. The Summit Board determined that this test was met in connection with the proposed Business Combination.

***Sponsor Consent Right***

In connection with the IPO, we agreed that we would not enter into a definitive agreement regarding an initial business combination without the prior written consent of the Sponsor. The Sponsor has consented to our entry into the Business Combination Agreement.

***Voting Restrictions in Connection with Extraordinary General Meeting***

Our Sponsor, directors and officers have agreed to vote in favor of the Business Combination, regardless of how Summit Public Shareholders vote.

***Redemption Rights for Summit Public Shareholders upon Completion of the Business Combination***

We will provide Summit Public Shareholders with the opportunity to redeem all or a portion of their Summit Public Shares upon our initial business combination's completion at a per-share price, payable in cash, equal to the aggregate amount then on deposit in the Trust Account calculated as of two business days before the closing of the initial business combination, including interest earned on the funds held in the Trust Account and not previously released to us to pay our income taxes, if any, divided by the number of then-outstanding Summit Public Shares, subject to the limitations described herein. The amount in the Trust Account is initially anticipated to be \$10.00 per Summit Public Share. The redemption rights will include the requirement that a beneficial holder must identify itself in order to validly redeem its Summit Public Shares. There will be no redemption rights upon the completion of our initial business combination with respect to Summit Warrants. Further, we will not proceed with redeeming Summit Public Shares, even if a Summit Public Shareholder has properly elected to redeem its Summit Public Shares, if a business combination does not close. See the section entitled "Extraordinary General Meeting of Summit Shareholders — Redemption Rights" for the procedures to be followed if you wish to redeem your Summit Public Shares for cash.

Our Sponsor, officers and directors have entered into an agreement with us, pursuant to which they have agreed to waive their redemption rights with respect to any Founder Shares and Summit Public Shares held by them in connection with (i) the completion of our initial business combination and (ii) a shareholder vote to approve an amendment to the Summit Articles (A) that would modify the substance or timing of our obligation to provide holders of Summit Public Shares the right to have their shares redeemed in connection with our initial business combination or to redeem 100% of the Summit Public Shares if we do not complete our initial business combination within 24 months from the closing of the IPO or (B) with respect to any other provision relating to the rights of holders of the Summit Public Shares.

***Limitations on Redemption Rights***

The Summit Articles provide that in no event will we redeem Summit Public Shares in an amount that would cause our net tangible assets to be less than \$5,000,001 (so that we do not then become subject to the SEC's "penny stock" rules). However, the proposed business combination may require: (i) cash consideration to be paid to the target or its owners, (ii) cash to be transferred to the target for working capital or other general corporate purposes or (iii) the retention of cash to satisfy other conditions in accordance with the terms of the proposed business combination. In the event the aggregate cash consideration we would be required to pay for all Summit Public Shares that are validly submitted for redemption plus any amount required to satisfy cash conditions pursuant to the terms of the proposed business combination exceed the aggregate amount of cash available to us, we will not complete the business combination or redeem any shares, and all Summit Public Shares submitted for redemption will be returned to the holders thereof.

***Redemption of Summit Public Shares and Liquidation if No Initial Business Combination***

The Summit Articles provide that we will have only 24 months from the closing of the IPO to consummate an initial business combination. If we have not consummated an initial business combination within 24 months from the closing of the IPO, we will: (i) cease all operations except for the purpose of winding up; (ii) as promptly as reasonably possible but not more than ten business days thereafter, redeem the Summit Public Shares, at a per-share price, payable in cash, equal to the aggregate amount then on deposit in the Trust Account, including interest earned on the funds held in the Trust Account and not previously released to us to pay our income taxes, if any (less up to \$100,000 of interest to pay dissolution expenses) divided by the number of the then-outstanding Summit Public Shares, which redemption will completely extinguish Summit Public Shareholders' rights as shareholders (including the right to receive further liquidation distributions, if any); and (iii) as promptly as reasonably possible following such redemption, subject to the approval of our remaining shareholders and our board of directors, liquidate and dissolve, subject in each case to our obligations under Cayman Islands law to provide for claims of creditors and the requirements of other applicable law. There will be no redemption rights or liquidating distributions with respect to the Summit Warrants, which will expire worthless if we fail to consummate an initial business combination within 24 months from the closing of the IPO. The Summit Articles will provide that, if we wind up for any other reason prior to the consummation of our initial business combination, we will follow the foregoing procedures with respect to the liquidation of the Trust Account as promptly as reasonably possible but not more than ten business days thereafter, subject to applicable Cayman Islands law.

Our Sponsor, officers and directors have entered into an agreement with us, pursuant to which they have agreed to waive their rights to liquidating distributions from the Trust Account with respect to any Founder Shares they hold if we fail to consummate an initial business combination within 24 months from the closing of the IPO (although they will be entitled to liquidating distributions from the Trust Account with respect to any Summit Public Shares they hold if we fail to complete our initial business combination within the prescribed timeframe).

Our Sponsor, officers and directors have agreed, pursuant to a written agreement with us, that they will not propose any amendment to the Summit Articles (A) that would modify the substance or timing of our obligation to provide holders of Summit Public Shares the right to have their shares redeemed in connection with our initial business combination or to redeem 100% of the Summit Public Shares if we do not complete our initial business combination within 24 months from the closing of the IPO or (B) with respect to any other provision relating to the rights of holders of Summit Public Shares, unless we provide the Summit Public Shareholders with the opportunity to redeem their Summit Public Shares upon approval of any such amendment at a per-share price, payable in cash, equal to the aggregate amount then on deposit in the Trust Account, including interest earned on the funds held in the Trust Account and not previously released to us to pay our income taxes, if any, divided by the number of the then-outstanding public shares, subject to the limitations described herein. However, we may not redeem the Summit Public Shares in an amount that would cause our net tangible assets to be less than \$5,000,001 (so that we do not then become subject to the SEC's "penny stock" rules). If this optional redemption right is exercised with respect to an excessive number of Summit Public Shares such that we cannot satisfy the net tangible asset requirement, we would not proceed with the amendment or the related redemption of the Summit Public Shares at such time. This redemption right shall apply in the event of the approval of any such amendment, whether proposed by our Sponsor, any officer or director, or any other person.

We expect that all costs and expenses associated with implementing our plan of dissolution, as well as payments to any creditors, will be funded from amounts remaining out of the \$1,000,000 held outside the Trust Account plus up to \$100,000 of funds from the Trust Account available to us to pay dissolution expenses, although we cannot assure you that there will be sufficient funds for such purpose.

Although we will seek to have all vendors, service providers (other than our independent registered public accounting firm), prospective target businesses and other entities with which we do business execute agreements with us waiving any right, title, interest or claim of any kind in or to any monies held in the Trust Account for the benefit of the Summit Public Shareholders, there is no guarantee that they will execute such agreements or even if they execute such agreements that they would be prevented from bringing claims against the Trust Account including, but not limited to, fraudulent inducement, breach of fiduciary responsibility or other similar claims, as well as claims challenging the enforceability of the waiver, in each case in order to gain

an advantage with respect to a claim against our assets, including the funds held in the Trust Account. If any third party refuses to execute an agreement waiving such claims to the monies held in the Trust Account, our management will perform an analysis of the alternatives available to it and will only enter into an agreement with a third party that has not executed a waiver if management believes that such third party's engagement would be significantly more beneficial to us than any alternative. Examples of possible instances where we may engage a third party that refuses to execute a waiver include the engagement of a third-party consultant whose particular expertise or skills are believed by management to be significantly superior to those of other consultants that would agree to execute a waiver or in cases where management is unable to find a service provider willing to execute a waiver. In addition, there is no guarantee that such entities will agree to waive any claims they may have in the future as a result of, or arising out of, any negotiations, contracts or agreements with us and will not seek recourse against the Trust Account for any reason.

In order to protect the amounts held in the Trust Account, our Sponsor has agreed that it will be liable to us if and to the extent any claims by a third party for services rendered or products sold to us (other than our independent registered public accounting firm), or a prospective target business with which we have discussed entering into a transaction agreement, reduce the amounts in the Trust Account to below the lesser of (i) \$10.00 per Summit Public Share and (ii) the actual amount per Summit Public Share held in the Trust Account as of the date of the liquidation of the Trust Account if less than \$10.00 per Summit Public Share due to reductions in the value of the trust assets, in each case net of the interest that may be withdrawn to pay our tax obligations, provided that such liability will not apply to any claims by a third party or prospective target business that executed a waiver of any and all rights to seek access to the Trust Account nor will it apply to any claims under our indemnity of the underwriter of the IPO against certain liabilities, including liabilities under the Securities Act. In the event that an executed waiver is deemed to be unenforceable against a third party, our Sponsor will not be responsible to the extent of any liability for such third-party claims. However, we have not asked our Sponsor to reserve for such indemnification obligations, nor have we independently verified whether our Sponsor has sufficient funds to satisfy its indemnity obligations and we believe that our Sponsor's only assets are securities of our company. Therefore, we cannot assure you that our Sponsor would be able to satisfy those obligations. None of our officers or directors will indemnify us for claims by third parties including, without limitation, claims by vendors and prospective target businesses.

In the event that the proceeds in the Trust Account are reduced below the lesser of (i) \$10.00 per Summit Public Share and (ii) the actual amount per Summit Public Share held in the Trust Account as of the date of the liquidation of the Trust Account if less than \$10.00 per Summit Public Share due to reductions in the value of the trust assets, in each case net of the amount of interest that may be withdrawn to pay our income tax obligations, and our Sponsor asserts that it is unable to satisfy its indemnification obligations or that it has no indemnification obligations related to a particular claim, our independent directors would determine whether to take legal action against our Sponsor to enforce its indemnification obligations. While we currently expect that our independent directors would take legal action on our behalf against our Sponsor to enforce its indemnification obligations to us, it is possible that our independent directors in exercising their business judgment may choose not to do so in any particular instance. Accordingly, we cannot assure you that due to claims of creditors the actual value of the per-share redemption price will not be less than \$10.00 per Summit Public Share.

We will seek to reduce the possibility that our Sponsor will have to indemnify the Trust Account due to claims of creditors by endeavoring to have all vendors, service providers (other than our independent registered public accounting firm), prospective target businesses or other entities with which we do business execute agreements with us waiving any right, title, interest or claim of any kind in or to monies held in the Trust Account. Our Sponsor will also not be liable as to any claims under our indemnity of the underwriter of the IPO against certain liabilities, including liabilities under the Securities Act. We have access to up to \$1,000,000 to pay any such potential claims (including costs and expenses incurred in connection with our liquidation, currently estimated to be no more than approximately \$100,000). In the event that we liquidate and it is subsequently determined that the reserve for claims and liabilities is insufficient, shareholders who received funds from the Trust Account could be liable for claims made by creditors, however such liability will not be greater than the amount of funds from the Trust Account received by any such shareholder.

If we file a bankruptcy or winding-up petition or an involuntary bankruptcy or winding-up petition is filed against us that is not dismissed, the proceeds held in the Trust Account could be subject to applicable

bankruptcy or insolvency law, and may be included in our bankruptcy estate and subject to the claims of third parties with priority over the claims of our shareholders. To the extent any bankruptcy claims deplete the Trust Account, we cannot assure you we will be able to return \$10.00 per Summit Public Share to Summit Public Shareholders. Additionally, if we file a bankruptcy or winding-up petition or an involuntary bankruptcy or winding-up petition is filed against us that is not dismissed, any distributions received by shareholders could be viewed under applicable debtor/creditor and/or bankruptcy or insolvency laws as either a “preferential transfer” or a “fraudulent conveyance.” As a result, a bankruptcy or insolvency court could seek to recover some or all amounts received by our shareholders. Furthermore, the Summit Board may be viewed as having breached its fiduciary duty to our creditors and/or may have acted in bad faith, and thereby exposing itself and our company to claims of punitive damages, by paying Summit Public Shareholders from the Trust Account prior to addressing the claims of creditors. We cannot assure you that claims will not be brought against us for these reasons.

Summit Public Shareholders will be entitled to receive funds from the Trust Account only (i) in the event of the redemption of the Summit Public Shares if we do not complete our initial business combination within 24 months from the closing of the IPO, (ii) in connection with a shareholder vote to amend the Summit Articles (A) to modify the substance or timing of our obligation to provide holders of Summit Public Shares the right to have their shares redeemed in connection with our initial business combination or to redeem 100% of the Summit Public Shares if we do not complete our initial business combination within 24 months from the closing of the IPO or (B) with respect to any other provision relating to the rights of holders of Summit Public Shares, or (iii) if they redeem their respective shares for cash upon the completion of the initial business combination. Summit Public Shareholders who redeem their Summit Public Shares in connection with a shareholder vote described in clause (ii) in the preceding sentence shall not be entitled to funds from the Trust Account upon the subsequent completion of an initial business combination or liquidation if we have not consummated an initial business combination within 24 months from the closing of the IPO, with respect to such Summit Public Shares so redeemed. In no other circumstances will a shareholder have any right or interest of any kind to or in the Trust Account. In the event we seek shareholder approval in connection with our initial business combination, such as in connection with the Business Combination, a shareholder’s voting in connection with the business combination alone will not result in a shareholder’s redeeming its shares to us for an applicable pro rata share of the Trust Account. Such shareholder must have also exercised its redemption rights described above. These provisions of the Summit Articles, like all provisions of the Summit Articles, may be amended with a shareholder vote.

See the section entitled “Risk Factors — Risks Related to Redemption of Summit Public Shares” and “Risk Factors — Risks Related to Summit and the Business Combination.”

### Employees

We currently have two executive officers. These individuals are not obligated to devote any specific number of hours to our matters but they intend to devote as much of their time as they deem necessary to our affairs until we have completed our initial business combination. The amount of time they will devote in any time period will vary based on whether a target business has been selected for our initial business combination and the stage of the business combination process we are in. We do not intend to have any full time employees prior to the completion of our initial business combination.

### Officers and Directors

Our directors and officer are as follows:

Name	Age	Position
Bo Tan	49	Chief Executive Officer, Co-Chief Investment Officer and Director
Ken Poon	55	President, Co-Chief Investment Officer and Director
Ian Stone	71	Independent Director
Thomas Folinsbee	55	Independent Director
Tao Bai	57	Independent Director

*Bo Tan*, our Chief Executive Officer and Co-Chief Investment Officer, has over 20 years of extensive experience in the financial and pharmaceutical industries. He is the founding partner of Hannut Capital since 2021 and was the President and Chief Financial Officer of 3S Bio from December 2016 to December 2019. During his tenure at 3S Bio, Mr. Tan led the privatization of 3SBio and its re-listing in Hong Kong in 2015, as well as the acquisition and integration of Sciprogen, Sirtan (Italy), Wanma and CP Guojian. From 2015 to 2019, Mr. Tan was voted the “Best CFO” for consecutive years in the Institutional Investor All-Asia Executive Team poll. Before joining 3S Bio, Mr. Tan served as the executive director and a member of Investment Committee of Bohai Industrial Investment Fund Management Company, a PRC-based private equity firm, and presided over the investment in The Chengdu Commercial Bank, from April 2007 to September 2008. Prior to that, Mr. Tan served as a vice president in the equity research division of Lehman Brothers Asia Limited from March 2006 to March 2007 and as a senior analyst at Macquarie Securities Asia in Hong Kong from October 2004 to February 2006. Mr. Tan is widely acclaimed for his stellar track record of combining business operations and capital market prowess and has long-standing strategic relationships with major MNCs. Mr. Tan received his Bachelor’s degree in Economics from Renmin University of China in July 1994, Master’s degree in Economics from the University of Connecticut in December 1996 and a Master of International Management from Thunderbird School of Global Management in August 1998. We believe that Mr. Tan is qualified to serve on our board of directors based on his extensive experience in the financial and pharmaceutical industries.

*Ken Poon*, our President and Co-Chief Investment Officer, has nearly 30 years of capital markets experiences in Asia and is the founding partner of XCap Partners Limited, a boutique advisory firm in Hong Kong. Prior to founding XCap Partners Limited in 2019, Mr. Poon served as the Asia Pacific Head of Capital Markets Origination at Citigroup, running the Equity Capital Markets, Debt Capital Markets and Acquisition Finance businesses for all Asia ex-Japan. Prior to his tenure at Citigroup, Mr. Poon served as the Head of Asia Equity Capital Markets at Merrill Lynch from August 1998 to May 2004. Mr. Poon has led a series of landmark transactions globally, including Alibaba’s \$25 billion NYSE IPO, Luye Pharmaceutical’s \$878 million HKSE IPO, Samsung Biologic’s \$2 billion KOSE IPO, Chungwha Telecom Taiwan’s \$1.6 billion NYSE IPO and privatization, Melco’s \$1.3 billion Nasdaq IPO, TSMC’s \$2.0 billion registered ADR offering, China Mobile’s \$7.2 billion simultaneous placement of equity and convertibles, China Netcom’s \$1.2 billion dual listed NYSE and HKSE IPO, China CITIC Bank’s \$5.9 billion HKSE IPO, Longor Group’s \$1.0 billion HKSE IPO, CRCC’s \$2.3 billion HKSE IPO, Global Logistics Property \$3 billion SGX IPO, PetroChina’s \$2.4 billion Equity Placement, Sands China’s \$2.5 billion HKSE IPO and AIA’s \$20 billion HKSE IPO. He also led numerous billion-dollar bond offerings for companies such as Hutshison/Vodafone, Temasek/Singapore Telecom and Korea Telecom. Mr. Poon holds a Bachelor of Commerce degree in Finance from The University of British Columbia. We believe that Mr. Poon is qualified to serve on our board of directors based on his extensive capital markets experience and expertise.

*Ian Stone*, our independent director, joined Pontis Partners, a consulting business specializing in the telecom, internet and media industries, in 2001, where he is currently a director. Through his position at Pontis Partners, Mr. Stone serves as a board member and advisor to a number of listed and private companies in the Asia and Middle East North Africa regions. In particular, Mr. Stone currently serves as an independent director of Tencent Holding Company (HKEX: 0700), one of Chinese largest online technology companies. He is a Board Advisor to the Planet N Group of companies which focuses on high-tech and social impact investing in MENA and South Asia. He was also an independent director at Panther Media Group, a MENA region media company, between October 2018 and September 2021. From 2001 to 2014 Mr. Stone served in various positions at PCCW, a leading telecommunications and media company in Hong Kong, including as managing director of various business units. Prior to this, Mr. Stone had been CEO of various mobile phone companies in Hong Kong, Indonesia and the Philippines. We believe that Mr. Stone is qualified to serve on our board of directors based on his management experience and business expertise.

*Thomas Folinsbee*, our independent director, has over 25 years of experience as a financial and securities professional. Mr. Folinsbee is the managing director of Optivest Canada Ltd, a private investment company. He was previously business development consultant of Shanghai Alebund Pharmaceuticals Ltd., a China-based pharmaceutical company, since 2019, where he was responsible for pharmaceutical inlicensing and outlicensing transactions. Prior to joining Alebund, Mr. Folinsbee was Director of Corporate Development of the strategic investment division of 3SBio Inc., a biotechnology company, from 2009 to 2019, focusing on sourcing business development opportunities in Canada, Australia, and Japan, including licensing,

distribution, and M&A. Mr. Folinsbee joined 3SBio to manage its investor relations activities and was a member of the management group that delisted 3SBio from Nasdaq in May 2013 and relisted it on the Hong Kong Stock Exchange in June 2016. From 2017 to 2019, Mr. Folinsbee also served as independent director of Bison Capital Acquisition Corporation, a special purpose acquisition company that acquired Xynomic Pharmaceuticals Holdings, Inc. in 2019. Mr. Folinsbee continued to serve as independent director and was a member of the audit and compensation committees after the acquisition. From 2011 to 2016, Mr. Folinsbee also worked for Hisanaga Seisakusho Co. Ltd., a Japanese manufacturing company, where he helped launch Hisanaga's sales platform in India and designed a business intelligence system to support a corporate turnaround. Before joining 3SBio Inc., Mr. Folinsbee also worked at Macquarie Equities, BNP Paribas and Optivest Systems Ltd. Mr. Folinsbee graduated in 1990 from McGill University with a Bachelor of Commerce degree concentrating in finance and international business (with distinction). We believe that Mr. Folinsbee is qualified to serve on our board of directors based on his financial and securities expertise and extensive experience in the pharmaceutical industry.

*Tao Bai*, our independent director, is a partner at the Beijing office of JunHe Law Offices. Prior to joining JunHe Law Offices in 2002, Ms. Bai was a founding partner at Commerce & Finance Law offices from 1992 to 2002. Prior to that, Ms. Bai practiced with C&C Law Offices in Beijing from 1989 to 1992. Over the years, Ms. Bai has provided comprehensive legal services to many international clients, including multinational corporations and international organizations, as well as large Chinese enterprises and trade organizations, in the fields of IP protection, anti-dumping, M&A, project financing, IPOs, litigation, arbitration and administrative actions. Ms. Bai is a member of the All-China Bar Association, a Standing Director of Beijing Intellectual Property Protection Association, a member of the Chinese Society of International Law and the Inter-Pacific Bar Association, the Vice President of Beijing Bar Association and an arbitrator of the China International Economic and Trade Arbitration Commission, Shanghai International Economic and Trade Arbitration Commission and Hainan Arbitration Commission. Ms. Bai received the Outstanding and Lifetime Achievement for Asia Women in Business Law award from the Euromoney Legal Media Group in 2016. Ms. Bai received her LL.B. degree from Peking University Law School in 1985 and her J.D. degree from Cornell Law School in 1988. We believe that Ms. Bai is qualified to serve on our board of directors based on her legal and business expertise.

#### **Number and Terms of Officers and Directors**

Our officers are appointed by the board of directors and serve at the discretion of the board of directors, rather than for specific terms of office. Our board of directors is authorized to appoint persons to the offices set forth in the Summit Articles as it deems appropriate. The Summit Articles will provide that our officers may consist of one or more chairman of the board, chief executive officer, president, chief financial officer, vice presidents, secretary, treasurer and such other offices as may be determined by the board of directors.

#### **Committees of the Board of Directors**

We have three standing committees: an audit committee, a nominating committee and a compensation committee. Subject to phase-in rules and a limited exception, the rules of Nasdaq and Rule 10A-3 of the Exchange Act require that the audit committee of a listed company be comprised solely of independent directors. Subject to phase-in rules and a limited exception, the rules of Nasdaq require that the compensation committee and the nominating committee of a listed company be comprised solely of independent directors.

#### ***Audit Committee***

Ian Stone, Thomas Folinsbee and Tao Bai serve as members of our audit committee. Our board of directors has determined that each of Ian Stone, Thomas Folinsbee and Tao Bai are independent under the Nasdaq listing standards and applicable SEC rules. Thomas Folinsbee serves as the chairman of the audit committee. Under the Nasdaq listing standards and applicable SEC rules, all the directors on the audit committee must be independent. Each member of the audit committee is financially literate and our board of directors has determined that Thomas Folinsbee qualifies as an "audit committee financial expert" as defined in applicable SEC rules.

We have adopted an audit committee charter, which details the principal functions of the audit committee, including:

- meeting with our independent registered public accounting firm regarding, among other issues, audits, and the adequacy of our accounting and control systems;
- monitoring the independence of the independent registered public accounting firm;
- verifying the rotation of the lead (or coordinating) audit partner having primary responsibility for the audit and the audit partner responsible for reviewing the audit as required by law;
- inquiring and discussing with management our compliance with applicable laws and regulations;
- pre-approving all audit services and permitted non-audit services to be performed by our independent registered public accounting firm, including the fees and terms of the services to be performed;
- appointing or replacing the independent registered public accounting firm;
- determining the compensation and oversight of the work of the independent registered public accounting firm (including resolution of disagreements between management and the independent registered public accounting firm regarding financial reporting) for the purpose of preparing or issuing an audit report or related work;
- establishing procedures for the receipt, retention and treatment of complaints received by us regarding accounting, internal accounting controls or reports which raise material issues regarding our financial statements or accounting policies;
- monitoring compliance on a quarterly basis with the terms of the IPO and, if any non-compliance is identified, immediately taking all action necessary to rectify such noncompliance or otherwise causing compliance with the terms of the IPO; and
- reviewing and approving all payments made to our existing shareholders, executive officers or directors and their respective affiliates. Any payments made to members of our audit committee will be reviewed and approved by our board of directors, with the interested director or directors abstaining from such review and approval.

#### ***Compensation Committee***

The members of our compensation committee are Ian Stone, Thomas Folinsbee and Tao Bai, and Ian Stone serves as chairman of the compensation committee.

Under the Nasdaq listing standards, we are required to have a compensation committee composed entirely of independent directors. Our board of directors has determined that each of Ian Stone, Thomas Folinsbee and Tao Bai are independent. We have adopted a compensation committee charter, which details the principal functions of the compensation committee, including:

- reviewing and approving on an annual basis the corporate goals and objectives relevant to our President's, Chief Executive Officer's and Chief Investment Officer's, evaluating our President's, Chief Executive Officer's and Chief Investment Officer's performance in light of such goals and objectives and determining and approving the remuneration (if any) of our President, Chief Executive Officer and Chief Investment Officer based on such evaluation;
- reviewing and approving the compensation of all of our other Section 16 executive officers;
- reviewing our executive compensation policies and plans;
- implementing and administering our incentive compensation and equity-based remuneration plans;
- assisting management in complying with our proxy statement and annual report disclosure requirements;
- approving all special perquisites, special cash payments and other special compensation and benefit arrangements for our executive officers and employees;
- producing a report on executive compensation to be included in our annual proxy statement; and
- reviewing, evaluating and recommending changes, if appropriate, to the remuneration for directors.

The charter also provides that the compensation committee may, in its sole discretion, retain or obtain the advice of a compensation consultant, legal counsel or other adviser and will be directly responsible for the



appointment, compensation and oversight of the work of any such adviser. However, before engaging or receiving advice from a compensation consultant, external legal counsel or any other adviser, the compensation committee will consider the independence of each such adviser, including the factors required by Nasdaq and the SEC.

#### ***Nominating and Corporate Governance Committee***

The members of our nominating committee are Ian Stone, Thomas Folinsbee and Tao Bai, and Tao Bai serves as chairman of the nominating committee. Under the Nasdaq listing standards, we are required to have a nominating committee composed entirely of independent directors. Our board of directors has determined that each of Ian Stone, Thomas Folinsbee and Tao Bai are independent.

The nominating committee is responsible for overseeing the selection of persons to be nominated to serve on our board of directors. The nominating committee considers persons identified by its members, management, shareholders, investment bankers and others.

The guidelines for selecting director nominees, which is specified in our charter, provide that persons to be nominated:

- should have demonstrated notable or significant achievements in business, education or public service;
- should possess the requisite intelligence, education and experience to make a significant contribution to the board of directors and bring a range of skills, diverse perspectives and backgrounds to its deliberations; and
- should have the highest ethical standards, a strong sense of professionalism and intense dedication to serving the interests of the shareholders.

The nominating committee will consider a number of qualifications relating to management and leadership experience, background, integrity and professionalism in evaluating a person's candidacy for membership on the board of directors. The nominating committee may require certain skills or attributes, such as financial or accounting experience, to meet specific board needs that arise from time to time and will also consider the overall experience and makeup of its members to obtain a broad and diverse mix of board members. The nominating committee does not distinguish among director nominees recommended by shareholders and other persons.

#### **Compensation Committee Interlocks and Insider Participation**

None of our officers currently serves, or in the past year has served, as a member of the compensation committee of any entity that has one or more officers serving on our board of directors.

#### **Code of Business Conduct and Ethics**

We have adopted a Code of Business Conduct and Ethics applicable to our directors, officers and employees. A copy of the Code of Business Conduct and Ethics and the charters of the committees of our board of directors is provided without charge upon request from us. If we make any amendments to our Code of Business Conduct and Ethics other than technical, administrative or other non-substantive amendments, or grant any waiver, including any implicit waiver, from a provision of the Code of Business Conduct and Ethics applicable to our principal executive officer, principal financial officer principal accounting officer or controller or persons performing similar functions requiring disclosure under applicable SEC or Nasdaq rules, we will disclose the nature of such amendment or waiver on Form 8-K.

#### **Conflicts of Interest**

Under Cayman Islands law, directors and officers owe the following fiduciary duties:

- duty to act bona fide in the best interests of the company;
- duty to exercise the powers that are vested in the director for the purpose for which they were conferred and not for some personal or collateral, or some other improper purpose;

- duty not to fetter the future exercise of the director's powers (for example, by agreeing to exercise the director's powers in accordance with the instructions of some third party);
- duty not to make a profit based on their positions as director (unless the company permits them to do so); and
- duty not to put themselves in a position in which there is an actual or potential conflict between their duty to the company and their personal interests or a duty owed to another person, including a shareholder whom the director represents on the board.

In addition to the above, directors also have a duty to exercise the skill they actually possess and such care and diligence that a reasonably prudent person would exercise in comparable circumstances. It was previously considered that a director need not exhibit in the performance of his duties a greater degree of skill than what may reasonably be expected from a person of his knowledge and experience. However, English and Commonwealth courts have moved towards an objective standard with regard to the required skill and care and these authorities are likely to be followed in the Cayman Islands.

As set out above, directors have a duty not to put themselves in a position of conflict and this includes a duty not to engage in self-dealing, or to otherwise benefit as a result of their position. However, in some instances what would otherwise be a breach of this duty can be forgiven and/or authorized in advance by the shareholders provided that there is full disclosure by the directors. This can be done by way of permission granted in the amended and restated memorandum and articles of association or alternatively by shareholder approval at general meetings.

Certain of our officers or directors presently have, and any of them in the future may have additional, fiduciary and contractual duties to other entities pursuant to which such officer or director is or will be required to present acquisition opportunities to such entity. As a result, if any of our officers or directors becomes aware of a business combination opportunity that is suitable for an entity to which he or she has then-current fiduciary or contractual obligations, then, subject to their fiduciary duties under Cayman Islands law, he or she will need to honor such fiduciary or contractual obligations to present such business combination opportunity to such entity, before we can pursue such opportunity. If these other entities decide to pursue any such opportunity, we may be precluded from pursuing the same. However, we do not expect these duties to materially affect our ability to complete our initial business combination. The Summit Articles provide that, to the fullest extent permitted by applicable law: (i) no individual serving as a director or an officer shall have any duty, except and to the extent expressly assumed by contract, to refrain from engaging directly or indirectly in the same or similar business activities or lines of business as us; and (ii) we renounce any interest or expectancy of Summit in, or in being offered an opportunity to participate in, any potential transaction or matter which may be a corporate opportunity for any director or officer, on the one hand, and us, on the other.

Below is a table summarizing the entities to which our officers and directors currently have fiduciary duties, contractual obligations or other material management relationships:

<b>Individual</b>	<b>Entity</b>	<b>Entity's Business</b>	<b>Affiliation</b>
Ken Poon	XCap Partners Limited	Financial Advisory	Founding Partner
Ian Stone	Tencent Holdings Ltd.	Tech Investment Management	Independent Director
Thomas Folinsbee	Optivest Canada Ltd	Private Investment	Managing Director
Bo Tan	Hannut Capital	Private Equity	Founding Partner

Potential investors should also be aware of the following other potential conflicts of interest:

Our officers and directors are not required to, and will not, commit their full time to our affairs, which may result in a conflict of interest in allocating their time between our operations and our search for a business combination and their other businesses. We do not intend to have any full-time employees prior to the completion of our initial business combination. Each of our officers and directors is engaged in, or may in the future engage in, several other business endeavors for which he or she may be entitled to substantial compensation, and our officers and directors are not obligated to contribute any specific number of hours per week to our affairs.

- Our Sponsor subscribed for Founder Shares prior to the completion of the IPO and purchased Summit Private Warrants in a transaction that closed simultaneously with the closing of the IPO.
- Our Sponsor, officers and directors have entered into an agreement with us, pursuant to which they have agreed to waive their redemption rights with respect to any Founder Shares and Summit Public Shares held by them in connection with (i) the completion of our initial business combination and (ii) a shareholder vote to approve an amendment to the Summit Articles (A) that would modify the substance or timing of our obligation to provide holders of Summit Public Shares the right to have their shares redeemed in connection with our initial business combination or to redeem 100% of the Summit Public Shares if we do not complete our initial business combination within 24 months from the closing of the IPO or during any Extension Period or (B) with respect to any other provision relating to the rights of holders of Summit Public Shares.

Additionally, our Sponsor has agreed to waive its rights to liquidating distributions from the Trust Account with respect to its Founder Shares if we fail to complete our initial business combination within the prescribed timeframe. If we do not complete our initial business combination within the prescribed timeframe, the Summit Private Warrants will expire worthless. Except as described herein, our Sponsor, officers and directors have agreed not to transfer, assign or sell any of their Founder Shares until the earliest of (A) one year after the completion of our initial business combination and (B) subsequent to our initial business combination, (x) if the closing price of Summit Public Shares equals or exceeds \$12.00 per share (as adjusted for share subdivisions, share capitalizations, reorganizations, recapitalizations and the like) for any 20 trading days within any 30-trading day period commencing at least 150 days after our initial business combination, or (y) the date on which we complete a liquidation, merger, share exchange or other similar transaction that results in all of the Summit Public Shareholders having the right to exchange their ordinary shares for cash, securities or other property. Except as described herein, the Summit Private Warrants will not be transferable until 30 days following the completion of our initial business combination. Because each of our officers and directors will own Summit Shares or Summit Warrants directly or indirectly, they may have a conflict of interest in determining whether a particular target business is an appropriate business with which to effectuate our initial business combination.

- Our Sponsor, officers and directors may have a conflict of interest with respect to evaluating a particular business combination if the retention or resignation of any such officers and directors is included by a target business as a condition to any agreement with respect to our initial business combination. In addition, our Sponsor, officers and directors may sponsor, form or participate in other blank check companies similar to ours during the period in which we are seeking an initial business combination. Any such companies may present additional conflicts of interest in pursuing an acquisition target, particularly in the event there is overlap among investment mandates.
- We are not prohibited from pursuing an initial business combination with a company that is affiliated with our Sponsor, officers or directors. In the event we seek to complete our initial business combination with such a company, we, or a committee of independent directors, would obtain an opinion from an independent investment banking firm or another independent firm that commonly renders valuation opinions for the type of company we are seeking to acquire or an independent accounting firm, that such an initial business combination is fair to our company from a financial point of view.

We are not prohibited from pursuing an initial business combination with a company that is affiliated with our Sponsor, officers or directors. In the event we seek to complete our initial business combination with a company that is affiliated with our Sponsor or any of our officers or directors, we, or a committee of independent directors, will obtain an opinion from an independent investment banking firm or another independent entity that commonly renders valuation opinions that such initial business combination is fair to our company from a financial point of view. We are not required to obtain such an opinion in any other context.

Furthermore, in no event will our Sponsor or any of our existing officers or directors, or their respective affiliates, be paid by us any finder's fee, consulting fee or other compensation prior to, or for any services they render in order to effectuate, the completion of our initial business combination. Further, commencing on the date our securities are first listed on Nasdaq, we will also reimburse an affiliate of our Sponsor for office space, utilities, administrative services and remote support services provided to us in the amount of \$10,000 per month.

We cannot assure you that any of the above-mentioned conflicts will be resolved in our favor.

If we seek shareholder approval, we will complete our initial business combination only if we obtain the approval of an ordinary resolution under Cayman Islands law, which requires the affirmative vote of a majority of the shareholders who attend and vote at a general meeting of the company. A quorum for such meeting will be present if holders of one-third of the issued and outstanding shares entitled to vote at the meeting are represented in person or by proxy. In such case, our initial shareholders have agreed to vote their Founder Shares and Summit Public Shares in favor of our initial business combination.

#### **Limitation on Liability and Indemnification of Officers and Directors**

Cayman Islands law does not limit the extent to which a company's memorandum and articles of association may provide for indemnification of officers and directors, except to the extent any such provision may be held by the Cayman Islands courts to be contrary to public policy, such as to provide indemnification against willful default, willful neglect, civil fraud or the consequences of committing a crime. The Summit Articles will provide for indemnification of our officers and directors to the maximum extent permitted by law, including for any liability incurred in their capacities as such, except through their own actual fraud, willful default or willful neglect. We have entered into agreements with our officers and directors to provide contractual indemnification in addition to the indemnification provided for in the Summit Articles. We have purchased a policy of officers' and directors' liability insurance that insures our officers and directors against the cost of defense, settlement or payment of a judgment in some circumstances and insures us against our obligations to indemnify our officers and directors.

Our officers and directors have agreed to waive any right, title, interest or claim of any kind in or to any monies in the Trust Account, and have agreed to waive any right, title, interest or claim of any kind they may have in the future as a result of, or arising out of, any services provided to us and will not seek recourse against the Trust Account for any reason whatsoever (except to the extent they are entitled to funds from the Trust Account due to their ownership of public shares). Accordingly, any indemnification provided will only be able to be satisfied by us if (i) we have sufficient funds outside of the Trust Account or (ii) we consummate an initial business combination.

Our indemnification obligations may discourage shareholders from bringing a lawsuit against our officers or directors for breach of their fiduciary duty. These provisions also may have the effect of reducing the likelihood of derivative litigation against our officers and directors, even though such an action, if successful, might otherwise benefit us and our shareholders. Furthermore, a shareholder's investment may be adversely affected to the extent we pay the costs of settlement and damage awards against our officers and directors pursuant to these indemnification provisions.

We believe that these provisions, the insurance and the indemnity agreements are necessary to attract and retain talented and experienced officers and directors.

#### **Executive Compensation**

None of our executive officers or directors have received any cash compensation for services rendered to us. Commencing on the date that our securities are first listed on Nasdaq through the earlier of consummation of our initial business combination and our liquidation, we will reimburse an affiliate of our Sponsor for office space, utilities, administrative services and remote support services provided to us in the amount of \$10,000 per month. In addition, our Sponsor, executive officers and directors, or their respective affiliates will be reimbursed for any out-of-pocket expenses incurred in connection with activities on our behalf such as identifying potential target businesses and performing due diligence on suitable business combinations. Our audit committee will review on a quarterly basis all payments that were made by us to our Sponsor, executive officers or directors, or their respective affiliates. Any such payments prior to an initial business combination will be made using funds held outside the Trust Account. Other than quarterly audit committee review of such reimbursements, we do not expect to have any additional controls in place governing our reimbursement payments to our directors and executive officers for their out-of-pocket expenses incurred in connection with our activities on our behalf in connection with identifying and consummating an initial business combination. Other than these payments and reimbursements, no compensation of any kind, including finder's and

consulting fees, will be paid by the company to our Sponsor, officers and directors, or their respective affiliates, for services rendered prior to completion of our initial business combination.

After the completion of our initial business combination, members of our management team who remain with us may be paid consulting or management fees from the combined company. All of these fees will be fully disclosed to shareholders, to the extent then known, in the proxy solicitation materials or tender offer materials furnished to our shareholders in connection with a proposed business combination. We have not established any limit on the amount of such fees that may be paid by the combined company to our directors or members of management. It is unlikely the amount of such compensation will be known at the time of the proposed business combination, because the directors of the post-combination business will be responsible for determining executive officer and director compensation. Any compensation to be paid to our executive officer will be determined, or recommended to the board of directors for determination, either by a compensation committee constituted solely by independent directors or by a majority of the independent directors on our board of directors.

We do not intend to take any action to ensure that members of our management team maintain their positions with us after the consummation of our initial business combination, although it is possible that some or all of our directors and officer may negotiate employment or consulting arrangements to remain with us after our initial business combination. The existence or terms of any such employment or consulting arrangements to retain their positions with us may influence our management's motivation in identifying or selecting a target business but we do not believe that the ability of our management to remain with us after the consummation of our initial business combination will be a determining factor in our decision to proceed with any potential business combination. We are not party to any agreements with our executive directors and officer that provide for benefits upon termination of employment.

### **Director Independence**

Nasdaq listing standards require that a majority of our board of directors be independent. Our board of directors has determined that Ian Stone, Thomas Folinsbee and Tao Bai are "independent directors" as defined in the Nasdaq listing standards. Our independent directors will have regularly scheduled meetings at which only independent directors are present.

### **Legal Proceedings**

There is no material litigation, arbitration or governmental proceeding currently pending against us or any members of our management team in their capacity as such.

### **Properties**

We currently maintain our executive offices at Unit 1101, 11th Floor, 1 Lyndhurst Tower, 1 Lyndhurst Terrace, Central, Hong Kong. The cost for our use of this space is included in the \$10,000 per month fee we will pay to an affiliate of our Sponsor for office space, utilities, administrative services and remote support services. We consider our current office space adequate for our current operations.

### **Competition**

If we succeed in effecting the Business Combination with YS Biopharma, there will be, in all likelihood, significant competition from their competitors. We cannot assure you that, subsequent to the Business Combination, we will have the resources or ability to compete effectively.

### **Periodic Reporting and Financial Information**

We have registered our Units, Summit Public Shares and Summit Warrants under the Exchange Act and have reporting obligations, including the requirement that we file annual, quarterly and current reports with the SEC. In accordance with the requirements of the Exchange Act, our annual reports will contain financial statements audited and reported on by our independent registered public accountants.

We will provide shareholders with audited financial statements of the prospective target business as part of the proxy solicitation or tender offer materials, as applicable, sent to shareholders. These financial statements

may be required to be prepared in accordance with, or reconciled to, GAAP, or IFRS, depending on the circumstances, and the historical financial statements may be required to be audited in accordance with the standards of the PCAOB. These financial statement requirements may limit the pool of potential target businesses we may acquire because some targets may be unable to provide such statements in time for us to disclose such statements in accordance with federal proxy rules and complete our initial business combination within the prescribed timeframe. We cannot assure you that any particular target business identified by us as a potential acquisition candidate will have financial statements prepared in accordance with the requirements outlined above, or that the potential target business will be able to prepare its financial statements in accordance with the requirements outlined above. To the extent that these requirements cannot be met, we may not be able to acquire the proposed target business. While this may limit the pool of potential acquisition candidates, we do not believe that this limitation will be material.

We are required to evaluate our internal control procedures for the fiscal year ending December 31, 2022 as required by the Sarbanes-Oxley Act. Only in the event we are deemed to be a large accelerated filer or an accelerated filer and no longer qualify as an emerging growth company will we be required to comply with the independent registered public accounting firm attestation requirement on our internal control over financial reporting. A target business may not be in compliance with the provisions of the Sarbanes-Oxley Act regarding adequacy of their internal controls. The development of the internal controls of any such entity to achieve compliance with the Sarbanes-Oxley Act may increase the time and costs necessary to complete any such acquisition.

We have filed a Registration Statement on Form 8-A with the SEC to voluntarily register our securities under Section 12 of the Exchange Act. As a result, we are subject to the rules and regulations promulgated under the Exchange Act. We have no current intention of filing a Form 15 to suspend our reporting or other obligations under the Exchange Act prior or subsequent to the consummation of our initial business combination.

We are a Cayman Islands exempted company. Exempted companies are Cayman Islands companies conducting business mainly outside the Cayman Islands and, as such, are exempted from complying with certain provisions of the Cayman Islands Companies Act. As an exempted company, we have applied for and received a tax exemption undertaking from the Cayman Islands government that, in accordance with Section 6 of the Tax Concessions Act (As Revised) of the Cayman Islands, for a period of 20 years from the date of the undertaking, no law which is enacted in the Cayman Islands imposing any tax to be levied on profits, income, gains or appreciations will apply to us or our operations and, in addition, that no tax to be levied on profits, income, gains or appreciations or which is in the nature of estate duty or inheritance tax will be payable (i) on or in respect of our shares, debentures or other obligations or (ii) by way of the withholding in whole or in part of a payment of dividend or other distribution of income or capital by us to our shareholders or a payment of principal or interest or other sums due under a debenture or other obligation of us.

We are an “emerging growth company,” as defined in Section 2(a) of the Securities Act, as modified by the JOBS Act. As such, we are eligible to take advantage of certain exemptions from various reporting requirements that are applicable to other public companies that are not “emerging growth companies,” including, but not limited to, not being required to comply with the auditor attestation requirements of Section 404 of the Sarbanes-Oxley Act, reduced disclosure obligations regarding executive compensation in our periodic reports and proxy statements, and exemptions from the requirements of holding a non-binding advisory vote on executive compensation and shareholder approval of any golden parachute payments not previously approved. If some investors find our securities less attractive as a result, there may be a less active trading market for our securities and the prices of our securities may be more volatile.

In addition, Section 107 of the JOBS Act also provides that an “emerging growth company” can take advantage of the extended transition period provided in Section 7(a)(2)(B) of the Securities Act for complying with new or revised accounting standards. In other words, an “emerging growth company” can delay the adoption of certain accounting standards until those standards would otherwise apply to private companies. We intend to take advantage of the benefits of this extended transition period.

We will remain an emerging growth company until the earlier of (1) the last day of the fiscal year (a) following the fifth anniversary of the completion of the IPO, (b) in which we have total annual gross revenue of at least \$1.235 billion, or (c) in which we are deemed to be a large accelerated filer, which means the market value of

Summit Public Shares that are held by non-affiliates equals or exceeds \$700 million as of the prior June 30, and (2) the date on which we have issued more than \$1.0 billion in non-convertible debt during the prior three-year period.

Additionally, we are a “smaller reporting company” as defined in Item 10(f)(1) of Regulation S-K. Smaller reporting companies may take advantage of certain reduced disclosure obligations, including, among other things, providing only two years of audited financial statements. We will remain a smaller reporting company until the last day of any fiscal year for so long as either (1) the market value of our ordinary shares held by non-affiliates is less than \$250 million as of the end of that year’s second fiscal quarter or (2) our annual revenues are less than \$100 million during such completed fiscal year and the market value of Summit Shares held by non-affiliates is less than \$700 million as of the end of that year’s second fiscal quarter.

## SUMMIT'S MANAGEMENT'S DISCUSSION AND ANALYSIS OF FINANCIAL CONDITION AND RESULTS OF OPERATION

*The following discussion and analysis of Summit's financial condition and results of operations should be read in conjunction with Summit's financial statements and the related notes to those statements included elsewhere in this proxy statement/prospectus. In addition to historical financial information, the following discussion contains forward-looking statements that involve risks and uncertainties. Summit's actual results could differ materially from those discussed in the forward-looking statements as a result of many factors, including those factors set forth in the sections titled "Risk Factors" and "Forward-Looking Statements", which you should review for a discussion of some of the factors that could cause actual results to differ materially from the results described in or implied by the forward-looking statements contained in the following discussion and analysis and elsewhere in this proxy statement/prospectus.*

### Overview

Summit is a blank check company incorporated on December 22, 2020 as a Cayman Islands exempted company for the purpose of effecting a merger, share exchange, asset acquisition, share purchase, reorganization or similar business combination with one or more businesses or entities. Summit reviewed a number of opportunities to enter into a business combination with an operating business, and entered into the Business Combination Agreement on September 29, 2022, as further described in the section entitled "The Business Combination Proposal" in this proxy statement/prospectus. Summit intends to effectuate the Business Combination using cash from the proceeds of the IPO, the sale of its Summit Private Warrants and forward purchase securities.

### Results of Operations

Summit has neither engaged in any operations nor generated any revenues to date. Summit's only activities since inception have been organizational activities, those necessary to prepare for the IPO, identifying a target company for its initial business combination and activities relating to the Business Combination Transactions. Summit does not expect to generate any operating revenues until after the completion of its initial business combination. Summit generates non-operating income in the form of interest income on marketable securities held in a U.S.-based trust account (the "Trust Account") with Continental Stock Transfer & Trust Company acting as trustee. It incurs expenses as a result of being a public company (for legal, financial reporting, accounting and auditing compliance), as well as expenses relating to due diligence on prospective initial business combination candidates and activities relating to the Business Combination Transactions.

For the nine months ended September 30, 2022, Summit had net income of \$14,551,968, which consists of interest income on investments held in the Trust Account of \$1,192,968, a change in fair value of warrant liabilities of \$8,008,547 and gain recognized on extinguishment of deferred underwriting commissions of \$7,000,000, offset by a change in fair value of Forward Purchase Agreement ("FPA") of \$423,987 and general and administrative expenses of \$1,225,560.

For the nine months ended September 30, 2021, Summit had net loss of \$3,646,267, which consists of general and administrative expenses of \$246,868, a change in fair value of FPA of \$2,807,021, a change in fair value of warrant liabilities of \$88,010 and transaction costs allocated to warrants of \$507,417, offset by interest income on investments held in the Trust Account of \$3,049.

### Liquidity and Capital Resources

On June 11, 2021, Summit consummated the IPO of 20,000,000 Units, at a price of \$10.00 per Unit, generating gross proceeds of \$200,000,000. Simultaneously with the closing of the IPO, Summit consummated the sale of 6,000,000 Summit Private Warrants to the Sponsor at a price of \$1.00 per warrant, generating gross proceeds of \$6,000,000. Following the IPO and the sale of the Summit Private Warrants, a total of \$200,000,000 was placed in the Trust Account. Summit incurred \$11,587,941 in transaction costs, including \$4,000,000 of underwriting commissions, \$7,000,000 of deferred underwriting commissions (which was ultimately waived in full in July 2022) and \$587,941 of other cash offering costs.

For the nine months ended September 30, 2022, cash used in operating activities was \$815,101, which consists of net income of \$14,551,968, an unrealized loss on change in fair value of FPA liability of \$423,987, an



unrealized gain on change in fair value of warrant liabilities of \$8,008,547, interest earned on investments held in the Trust Account of \$1,192,968, gain recognized on extinguishment of deferred underwriting commissions of \$7,000,000 and changes in operating assets and liabilities, which provided \$410,459 of cash from operating activities.

For the nine months ended September 30, 2021, cash used in operating activities was \$423,286, which consists of net loss of \$3,646,267, an unrealized loss on change on fair value of warrants and FPA warrants of \$2,895,031, transaction costs allocable to warrants of \$507,417, offset by interest earned on investments held in the Trust Account of \$3,049, and changes in operating assets and liabilities, which provided \$176,418 of cash from operating activities.

As of September 30, 2022, Summit had investments held in the Trust Account of \$201,200,243. Summit intends to use substantially all of the funds held in the Trust Account, including any amounts representing interest earned on the Trust Account (which interest shall be net of taxes payable) to complete a business combination. To the extent that its share capital is used, in whole or in part, as consideration to complete a business combination, the remaining proceeds held in the Trust Account will be used as working capital to finance the operations of the target business or businesses, make other acquisitions and pursue its growth strategies.

As of September 30, 2022, Summit had cash of \$70,097 held outside of the Trust Account. Summit intends to use the funds for working capital purpose primarily to identify and evaluate target businesses, perform business due diligence on prospective target businesses, travel to and from the offices, plants or similar locations of prospective target businesses or their representatives or owners, review corporate documents and material agreements of prospective target businesses, structure, negotiate and complete a business combination.

In order to fund working capital deficiencies or finance transaction costs in connection with a business combination, the Sponsor or an affiliate of the Sponsor or certain of Summit's officers and directors may, but are not obligated to, loan Summit funds as may be required. If Summit completes a business combination, it would repay such loaned amounts. In the event that a business combination does not close, Summit may use a portion of the working capital held outside the Trust Account to repay such loaned amounts, but no proceeds from its Trust Account would be used for such repayment. Up to \$1,500,000 of such loans may be convertible into warrants, at a price of \$1.00 per warrant unit at the option of the lender. The warrants would be identical to the Summit Private Warrants.

If Summit's estimate of the costs of identifying a target business, undertaking in-depth due diligence and negotiating a business combination are less than the actual amount necessary to do so, Summit may have insufficient funds available to operate its business prior to its initial business combination. Moreover, Summit may need to obtain additional financing either to complete its business combination (including the Business Combination) or because Summit becomes obligated to redeem a significant number of the Summit Public Shares upon completion of its business combination (including the Business Combination), in which case it may issue additional securities or incur debt in connection with such business combination.

If Summit is unable to raise additional capital, it may be required to take additional measures to conserve liquidity, which could include, but not necessarily be limited to, curtailing operations, suspending the pursuit of a potential transaction, and reducing overhead expenses. Summit cannot provide any assurance that new financing will be available to it on commercially acceptable terms, if at all.

Summit has until June 11, 2023 to consummate a business combination. It is uncertain that it will be able to consummate a business combination by such date. If a business combination is not consummated by the required date, Summit will commence an automatic winding up, dissolution and liquidation. In connection with its assessment of going concern considerations in accordance with Financial Accounting Standard Board's Accounting Standards Update ("ASU") 2014-15, "Disclosures of Uncertainties about an Entity's Ability to Continue as a Going Concern," the management has determined that the liquidity condition and automatic liquidation, should a business combination not occur, and potential subsequent dissolution raises substantial doubt about its ability to continue as a going concern. No adjustments have been made to the carrying amounts of assets or liabilities should Summit be required to liquidate after June 11, 2023.

**Off-Balance Sheet Financing Arrangements**

Summit had no obligations, assets or liabilities, which would be considered off-balance sheet arrangements as of September 30, 2022. Summit does not participate in transactions that create relationships with unconsolidated entities or financial partnerships, often referred to as variable interest entities, which would have been established for the purpose of facilitating off-balance sheet arrangements. Summit has not entered into any off-balance sheet financing arrangements, established any special purpose entities, guaranteed any debt or commitments of other entities, or purchased any non-financial assets.

**Contractual Obligations**

Summit does not have any long-term debt, capital lease obligations, operating lease obligations or long-term liabilities, other than an agreement to pay the Sponsor a monthly fee of up to \$10,000 for office space, and administrative and support services, provided to Summit. Summit began incurring these fees on June 8, 2021 and will continue to incur these fees monthly until the earlier of the completion of a business combination and Summit's liquidation.

**Critical Accounting Policies**

The preparation of condensed financial statements and related disclosures in conformity with accounting principles generally accepted in the United States of America requires Summit's management to make estimates and assumptions that affect the reported amounts of assets and liabilities, disclosure of contingent assets and liabilities at the date of the financial statements, and income and expenses during the periods reported. Actual results could materially differ from those estimates. Summit has identified the following critical accounting policies:

***Derivative Financial Instruments***

Summit evaluates its financial instruments to determine if such instruments are derivatives or contain features that qualify as embedded derivatives in accordance with ASC Topic 815, "Derivatives and Hedging." For derivative financial instruments that are accounted for as liabilities, the derivative instrument is initially recorded at its fair value on the grant date and is then re-valued at each reporting date, with changes in the fair value reported in the statements of operations. The classification of derivative instruments, including whether such instruments should be recorded as liabilities or as equity, is evaluated at the end of each reporting period. Derivative liabilities are classified in the balance sheet as current or non-current based on whether or not net-cash settlement or conversion of the instrument could be required within 12 months of the balance sheet date.

***Warrant Liability and Forward Purchase Agreement***

Summit accounts for the 16,000,000 Summit Warrants issued in connection with the IPO (including the 10,000,000 Summit Public Warrants and the 6,000,000 Summit Private Warrants) and FPA in accordance with the guidance contained in FASB ASC 815 "Derivatives and Hedging" whereby under that provision the warrants and FPA do not meet the criteria for equity treatment and must be recorded as liabilities. Accordingly, Summit will classify Summit Warrants and FPA as liabilities at their fair value. These liabilities are subject to re-measurement at each reporting period. With such re-measurement, the changes in fair value are recognized in the Statement of Operations in the period of change. Derivative warrant liabilities and FPA are classified as non-current liabilities as their liquidation is not reasonably expected to require the use of current assets or require the creation of current liabilities.

***Class A Ordinary Shares Subject to Possible Redemption***

Summit accounts for Summit Class A Ordinary Shares (i.e., Summit Public Shares) subject to possible redemption in accordance with the guidance in ASC Topic 480 "Distinguishing Liabilities from Equity." Ordinary shares subject to mandatory redemption (if any) are classified as a liability instrument and measured at fair value. Conditionally redeemable ordinary shares (including ordinary shares that feature redemption rights that are either within the control of the holder or subject to redemption upon the occurrence of uncertain events not solely within Summit's control) are classified as temporary equity. At all other times,

ordinary shares are classified as shareholders' equity. Summit Class A Ordinary Shares feature certain redemption rights that are considered to be outside of its control and subject to the occurrence of uncertain future events. Accordingly, as of both September 30, 2022 and December 31, 2021, 20,000,000 Summit Class A Ordinary Shares, subject to possible redemption, are presented at redemption value as temporary equity, outside of the shareholders' (deficit) equity section of Summit's balance sheet.

#### ***Net Income (Loss) Per Share of Ordinary Shares***

Summit has two classes of shares, Summit Class A Ordinary Shares (i.e., Summit Public Shares) and Summit Class B Ordinary Shares (i.e., Founder Shares). Earnings and losses are shared pro rata between the two classes of shares. The 16,000,000 potential Summit Class A Ordinary Shares for outstanding warrants to purchase Summit Class A Ordinary Shares were excluded from diluted earnings per share for the nine months ended September 30, 2022 because the warrants are contingently exercisable, and the contingencies have not yet been met. As a result, diluted net income (loss) per common share is the same as basic net income (loss) per common share for the periods.

#### **Recent Accounting Pronouncements**

In August 2020, the Financial Accounting Standards Board ("FASB") issued Accounting Standards Update ("ASU") 2020-06, Debt — Debt with Conversion and Other Options (Subtopic 470-20) and Derivatives and Hedging — Contracts in Entity's Own Equity (Subtopic 815-40) ("ASU 2020-06") to simplify accounting for certain financial instruments. ASU 2020-06 eliminates the current models that require separation of beneficial conversion and cash conversion features from convertible instruments and simplifies the derivative scope exception guidance pertaining to equity classification of contracts in an entity's own equity. The new standard also introduces additional disclosures for convertible debt and freestanding instruments that are indexed to and settled in an entity's own equity. ASU 2020-06 amends the diluted earnings per share guidance, including the requirement to use the if-converted method for all convertible instruments. ASU 2020-06 is effective January 1, 2024 for smaller reporting companies and should be applied on a full or modified retrospective basis, with early adoption permitted beginning on January 1, 2021. Summit is currently assessing the impact, if any, that ASU 2020-06 would have on its financial position, results of operations or cash flows.

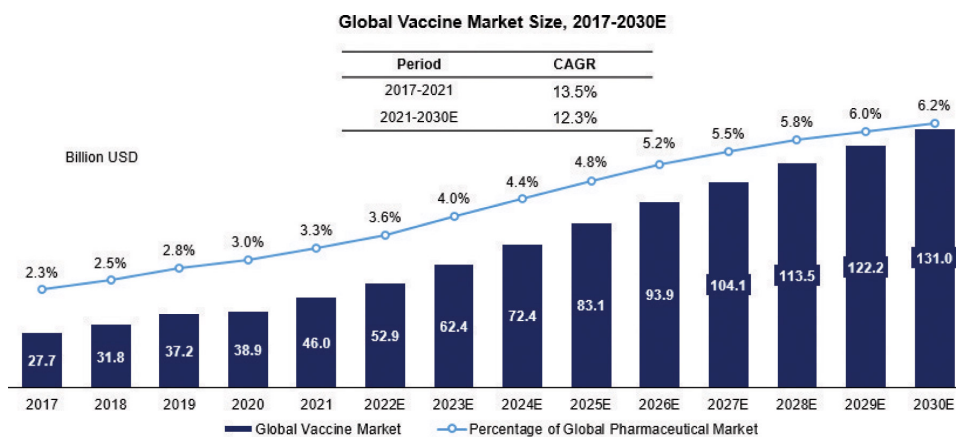
Summit's management does not believe that any other recently issued, but not yet effective, accounting standards, if currently adopted, would have a material effect on Summit's financial statements.

## YS GROUP'S MARKET OPPORTUNITIES

The information presented in this section has been derived from an industry report, or the F&S report, commissioned by YS Biopharma and issued in September 2022 by Frost & Sullivan, an independent research firm to provide information regarding the industry and market position of YS Biopharma in China.

### Global Vaccine Market Overview

Vaccines, a type of preventative pharmaceutical product that provides active acquired immunity against one or several diseases, have gradually been recognized an effective means to suppress the global and regional spread of infectious diseases and represented a growing share of the expanding global pharmaceutical market, according to the F&S Report. In terms of sales revenue, the global vaccine market increased from \$27.7 billion in 2017 to \$46.0 billion in 2021, at a CAGR of 13.5%, and is expected to reach \$131.0 billion in 2030, at a CAGR of 12.3% from 2021 to 2030, mainly driven by the launch of innovative vaccines and sales growth in emerging markets such as China, according to the same source.



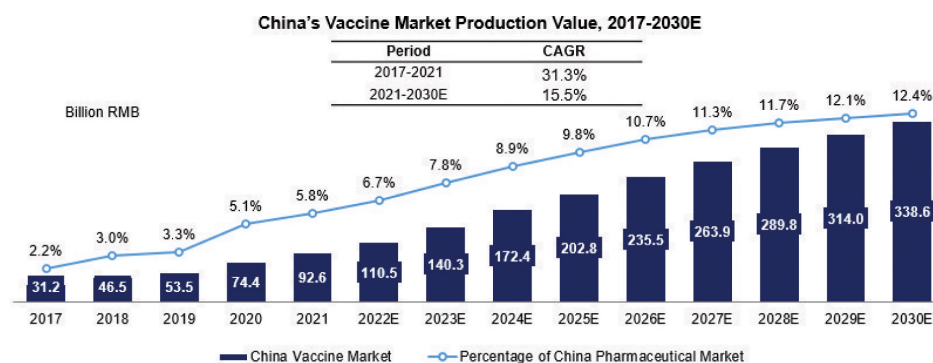
Note: the global market size is revenue based and forecasted based on the data of 2022Q3. COVID-19 vaccine market is currently not taken into consideration

Source: Expert interview, company annual report, Frost & Sullivan analysis

### China's Vaccine Market

#### Overview of China's vaccine market

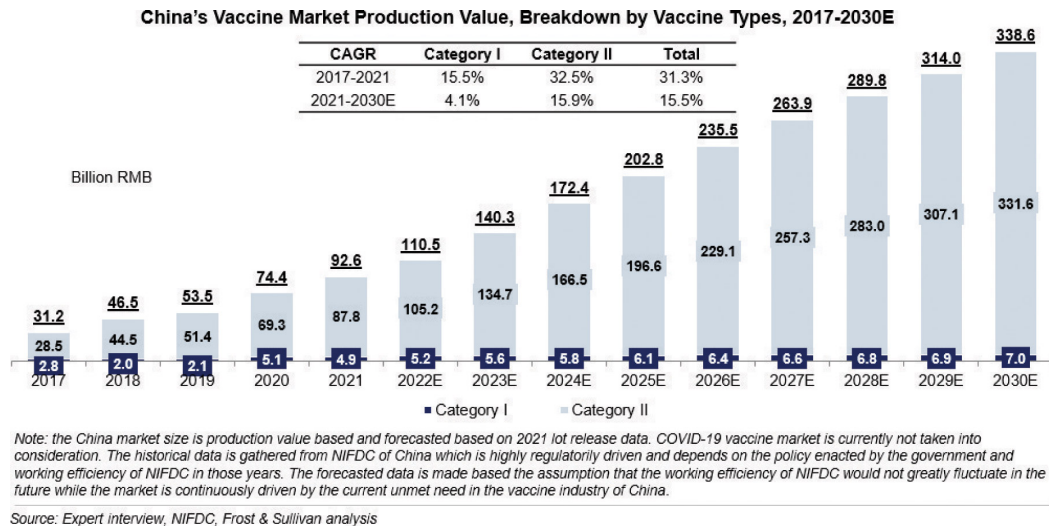
China's vaccine market has generally increased rapidly in the past few years and is expected to continue to grow significantly in the near future. According to the F&S Report, China's vaccine market, in terms of market production value, generally increased from RMB31.2 billion in 2017 to RMB92.6 billion in 2021, at a CAGR of 31.3%, and is expected to reach RMB338.6 billion in 2030, at a CAGR of 15.5% from 2021 to 2030.



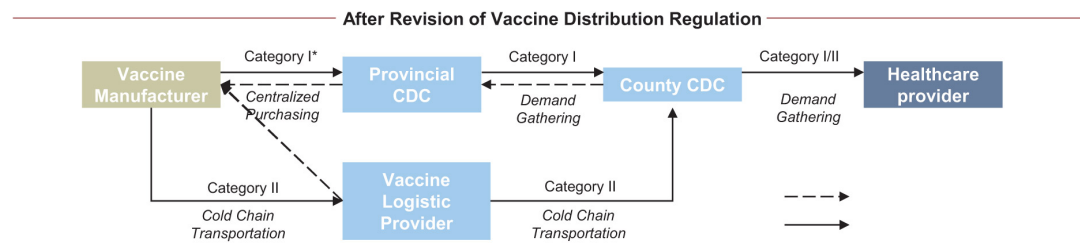
Note: the China market size is production value based and forecasted based on 2021 lot release data. COVID-19 vaccine market is currently not taken into consideration. The historical data is gathered from NIFDC of China which is highly regulatorily driven and depends on the policy enacted by the government and working efficiency of NIFDC in those years. The forecasted data is made based the assumption that the working efficiency of NIFDC would not greatly fluctuate in the future while the market is continuously driven by the current unmet need in the vaccine industry of China.

Source: Expert interview, NIFDC, Frost & Sullivan analysis

Vaccines in China can be categorized into Category I vaccines and Category II vaccines. Category I vaccines refer to the mandatory vaccines purchased by provincial-CDCs through government-organized tenders and offered to end users for free. Category II vaccines are paid for by customers or their insurers, which creates a market composed of China’s growing number of health-conscious customers who are both able and willing to pay a premium for high-quality vaccines. China’s vaccine market is dominated by Category II vaccines, and certain categories of vaccines, such as human rabies vaccines, are exclusively offered as Category II vaccines, according to the F&S Report. In 2021, Category II vaccine accounted for 94.7% of the total market production value, and is expected to account for 97.9% of the total market production value by 2030, according to the same source.



With respect to Category II vaccines, manufacturers generally must win bids in public tender process of the relevant province-level CDCs, which give them qualification to access the provincial market. Manufacturers are then required to make direct sales to, and settle payment with, county-level CDCs. The only exception is the Beijing CDC, who purchase Category II vaccines from manufacturers through its public tender process and allocate to county-level CDCs under its administration. With respect to Category I vaccines, province-level CDCs purchase vaccines through centralized bidding process and allocate to county-level CDCs, which in turn allocate to vaccine locations on an as-needed basis. Vaccine manufacturers may directly distribute Category I vaccines to province-level CDCs or county-level CDCs. County-level CDCs may distribute both Category I and II vaccines to healthcare providers.



*\*Note: Vaccine manufactures should supply the Category I vaccines to provincial CDCs or other CDCs based on the agreement of the government procurement contract. Source: Frost & Sullivan analysis*

According to the NIFDC and the F&S Report, rabies vaccines rank first among all vaccine categories in China in terms of lot release quantity in 2021.

The following table sets forth the top 10 types of vaccines ranked by the number of lot release in China in 2021.

**Top 10 Types of Vaccines Ranked by Number of Lot Release in China in 2021**

Rank	Vaccine	Number of Lot release
1	Rabies Vaccine	983
2	Hepatitis B Vaccine	565
3	Meningitis Vaccine	563
4	Flu Vaccine (Including HIB)	553
5	Varicella vaccine	471
6	Polio Vaccine	339
7	MMR Vaccine	281
8	HPV Vaccine	254
9	Japanese Encephalitis Vaccine	224
10	DPT Vaccine	203

Note: COVID-19 vaccines are not included.

Source: Frost & Sullivan analysis

#### **Growth drivers of China's vaccine market**

The major growth drivers of China's vaccine market, in particular with respect to Category II vaccines, include:

- *Increasing health awareness coupled with better affordability.* Economic opening up and growth, together with the improvement in education level and life quality in China have equipped Chinese people with a higher level of health-oriented knowledge and awareness, including the importance of vaccination. The increase in disposable income of Chinese people also leads to higher expenditure in managing their health, enhancing the demand for Category II vaccines which depend less on government reimbursement.
- *Supply of vaccines short of demand.* As a result of the Changchun Changsheng vaccine scandal in July 2018, the number of vaccine lot release in 2018 dropped significantly, causing a significant and prolonged impact on the supply of Category II vaccines in China. Although the vaccine market has begun to recover, the demand of vaccine still exceeds supply.
- *Advent of innovative vaccines with lack of effective treatment.* Along with the growing efforts in the research and development of innovative vaccines, more next-generation Category II vaccines for diseases such as rabies, malaria, HPV, tuberculosis are likely to debut, accompanied by improved product quality such as better protection and cost savings. Moreover, for many infectious diseases, such as rabies, no effective treatments are available, which makes vaccination the only method to reduce the harmful consequences and drives sustainable market demand.
- *Favorable government policies.* Given the importance of vaccination to public health in containing infections, the Chinese government has issued multiple policies to ramp up the capabilities to develop vaccines domestically and promote immunization program, all of which will drive the expansion of the vaccine market.

#### **Entry barriers of China's vaccine market**

The major entry barriers of China's vaccine market include:

- *Difficulties in the R&D of innovative vaccines.* Not all participants in the human vaccination industry are able to engage in each key step towards market success in the vaccine industry, consisting of research and development, manufacture and commercialization. In particular, the research and development of innovative vaccines involves a long-term process with substantial risk of failure and requiring significant capital investments, scientific and technological expertise, and human resources.

- *Stringent regulations of vaccine manufacture.* Vaccine manufacture is under stringent regulation in China to safeguard the quality and safety of vaccine products. Regulatory measures include compulsory inspection and review of each lot of vaccine products and on-site verification and sampling, setting high barrier for potential new entrants.
- *Establishment of sales and marketing channels.* The vaccine distribution channels involve multiple parties, such as county-level CDCs and service providers, with which manufacturers must form stable relationship to maintain and expand their sales and marketing channels. Potential new entrants may not be able to compete with existing main market players due to the significant efforts involved in forming such relationship.

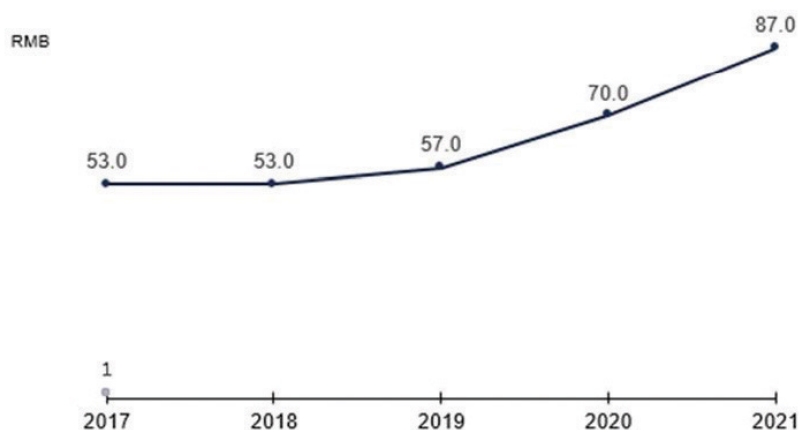
### **Human rabies vaccines market**

#### *Overview*

Rabies is a vaccine-preventable viral zoonotic disease primarily caused by the transmission of rabies virus to humans via infected animals, including primarily pet dogs. Rabies occurs in more than 150 countries and territories and accounts for an estimate of 59,000 human deaths in 2015, with over 95% human deaths occurring in developing countries in Asia and Africa, according to the F&S Report. The mortality rate of rabies is nearly 100% post exposure without the administration of post-exposure prophylaxis (“PEP”), which makes human rabies vaccine essential for the prevention of rabies, according to the same source. PEP must be applied using appropriate vaccine regimens and administration routes of proven safety and effectiveness. Generally, grade II exposure to rabies virus, which involves nibbling of uncovered skin, minor scratches or abrasions without bleeding, requires immediate vaccination. Grade III exposure, which involves more serious exposure such as single or multiple transdermal bites or scratches and contamination of mucous membrane or broken skin with saliva from animal licks, calls for both immediate vaccination and administration of rabies immunoglobulin.

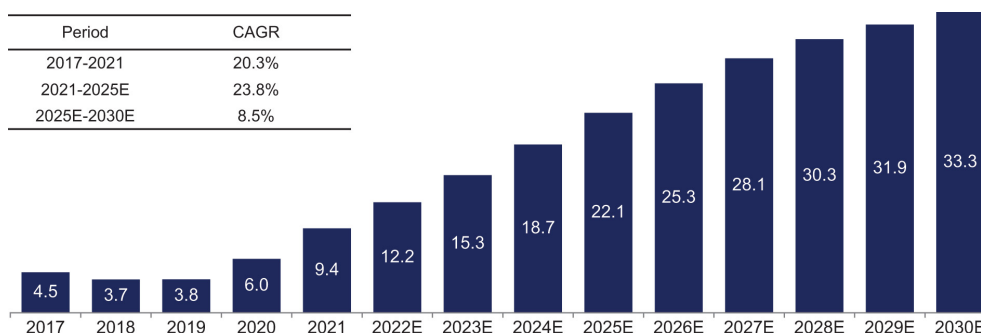
Unlike the developed countries in which vaccination for pets is the main method to control rabies, immediate PEP for human is the most effective method to control the death toll of rabies in less developed countries and regions with high bite incidence and mortality, according to the F&S Report. The median bidding price of rabies vaccine under Vero cell line per dose has increased steadily in China in the past three years, growing from RMB53.0 in 2017 to RMB70.0 in 2020, and further to RMB87.0 in 2021, according to the F&S Report.

**Median Bidding Price of Rabies Vaccine (Vero Cell) Per Dose in China, 2017-2021**



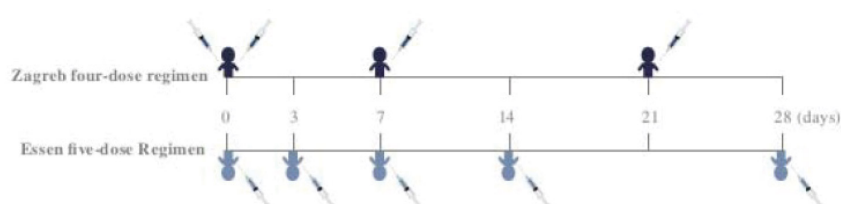
China’s rabies vaccine market production increased from RMB4.5 billion in 2017 to RMB9.4 billion in 2021, at a CAGR of 23.8%, and is expected to reach RMB22.1 billion in 2025, at a CAGR of 23.8% from 2021 to 2025. The following table sets forth the future trend of China’s rabies vaccine market production value.

### China's Rabies Vaccine Market Production Value, 2017–2030E



Source: Expert interview, Frost & Sullivan Analysis

There are two regimens for rabies in China, i.e., Essen five-dose regimen and Zagreb 2-1-1 regimen.



Source: Frost & Sullivan analysis

Starting from July 2018, China Food and Drug Administration (“CFDA”), now known as the National Medical Products Administration, carried out a series of inspections on Changchun Changsheng, which revealed that the company had been blending different lots of vaccine fluid, falsifying production date, using expired fluid in batch production and forging permits. Changchun Changsheng’s illegal production of rabies vaccine led to the CFDA’s measures to strengthen relevant regulations, including the comprehensive inspection on all vaccines in China covering the entire supply chain comprising raw material procurement, manufacturing, and the signing and issuance of lot release. China’s human rabies vaccine market production value is expected to increase from RMB9.4 billion in 2021 to RMB22.1 billion in 2025, at a CAGR of 23.8%, and is expected to reach RMB33.3 billion in 2030, at a CAGR of 8.5% from 2025 to 2030, according to the F&S Report. The expected growth rates of China’s rabies vaccine production value are based on several assumptions, including: (1) the expected increase in vaccination rate, (2) the introduction of more high-value rabies vaccines, and (3) the expected penetration rate of rabies vaccine which is estimated to reach 75% in 2030 and will remain well below 100% in the foreseeable future.

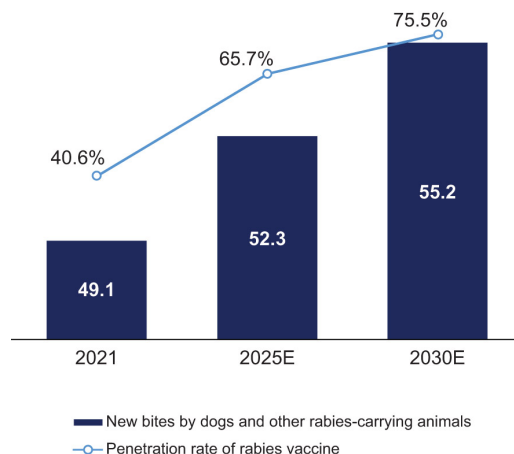
The current estimation of China’s rabies vaccine market takes into account multiple factors, such as the status quo of the current market, including (1) the increase in China’s pet dog population and the low veterinary vaccination rate, which has led to a large stray dog population with a low immunity rate, (2) the particular low penetration rate of veterinary rabies vaccine in China’s rural areas due to limited funding, which fails to establish epidemic prevention, and (3) the lack of established surveillance system for rabies-carrying animals in China. This estimation also takes into account new initiatives that may impact the future market, such as the revised animal epidemic prevention law. In particular, the revised animal immunization law may have the following impacts on the expected market production value of rabies vaccine in China in light of the status quo. The complete elimination of rabies in China may take years and the demand for human rabies vaccine is likely to sustain according to the F&S Report. For instance, while Mexico adopted the national initiative to control and eliminate rabies in the 1990s, which included comprehensive measures such as mass vaccination for dogs, continuous and effective surveillance programs and mass availability of PEP in its public health services, it did not obtain WHO validation for eliminating human rabies transmitted by dogs until 2019. The



currently marketed rabies vaccine for animal use in China can only provide protection of 12 to 36 months and mandate subsequent vaccination. Additionally, it is difficult to identify animals infected with rabies, which implies the difficulty of eradication of rabies solely through animal vaccination. Moreover, given the high fatality upon rabies infection, it is expected that people may still opt to be administered with rabies vaccines after being bitten by vaccinated pets, which may drive a continuous demand for human rabies vaccine in China. In addition, the prevention of rabies in rural areas in China still requires human rabies vaccines, considering the insufficient resources to implement effective veterinary prevention system and the large geographic scope.

The number of people bitten by dogs and other rabies-carrying animals in China in 2021 was approximately 49 million, and that number is expected to increase to 52 million in 2025 and 55 million in 2030. The penetration rate of rabies vaccine was 40.6% in 2021, and is expected to increase to 65.7% in 2025 and 75.5% in 2030. The following table sets forth the future trend of China's number of new bites and penetration of the rabies vaccine.

**China Number of New Bites and Penetration of Rabies Vaccine in 2021, 2025E, and 2030E**



Note: The penetration rate is calculated by dividing the lot release quantity of human rabies vaccine by estimated total number of rabies vaccines required theoretically.

Source: Expert interview, NIFDC, Frost & Sullivan analysis

The following table sets forth the market size of China's rabies vaccine market in terms of lot release, according to the F&S Report.

Year	2012	2013	2014	2015	2016	2017	2018	2019	2020	2021
<b>Lot release (in million doses)</b>	126.2	73.3	58.8	77.8	58.9	78.2	62.9	58.8	78.6	88.0

Source: NIFDC, Frost & Sullivan analysis

The human rabies vaccine market can be further divided according to the different cell lines used in manufacturing. According to the F&S Report, rabies vaccine under the Vero cell-line accounted for approximately 88.8% of the total lot release in China in 2021, compared with that of 5.8% and 5.4% for primarily hamster kidney cell ("PHKC") line and human diploid cell line, respectively. Vero cells are expected to continue to be the mainstream cell line to produce human rabies vaccines in the near future, according to the F&S Report. Vero cells have advantages over human diploid cells and PHKC in the evaluation of the efficiency of cell culture. The risk of exogenous contamination during production from Vero cells in a bioreactor is also lower than that of PHKC. In addition, it is difficult to scale up production with human diploid cells due to the associated high technical standards. Furthermore, according to the F&S Report and as revealed in several studies, the effect of rabies vaccines based on Vero cells is comparable to that of the vaccines based on the more expensive human diploid cells.

### ***Growth drivers and future trends of China's rabies vaccine market***

The primary growth drivers and future trends of China's rabies vaccine market include:

- *High demand for human rabies vaccines.* The pet dog population in China has grown rapidly in the past few years, increasing from approximately 87 million in 2017 to approximately 100 million in 2021, according to the F&S Report. With China's societal development and demographic changes, the number of pet dogs is likely to continue growing. Moreover, the number of stray dogs may continue to grow due to underregulated pet abandonment. However, the penetration rate of human rabies vaccine in China is still low.
- *Insufficient supply of human rabies vaccines.* New regulations in China have imposed stringent standards on human rabies vaccines, such as virus cultivation and purification and the environment of manufacturing facilities, which eliminates those suppliers unable to upgrade their product line and technologies. The expiration date of rabies vaccines is relatively short, which could further lower the supply.
- *Lack of animal vaccination.* The increase in both pet dog and stray dog population, coupled with the absence of effective animal vaccination programs in developing countries such as China, makes people more susceptible to bites by infected animals. Therefore, the demand for human rabies vaccine will continue to increase and drive the growth in sales volume and revenue.
- *Broader overseas market.* Given the continuous efforts to promote rabies vaccination in those countries and regions where people still have relatively low awareness of rabies vaccination, the vaccination rates in those markets have the potential to increase in the future, which will present more opportunities for vaccine companies in China to expand overseas. Moreover, due to the serious lack of human rabies vaccine manufacturers in those markets with high incidence of rabies, Chinese rabies vaccine manufacturers have the opportunity to capture the increasing demand underserved by the local suppliers in those markets, which will drive the growth of the export market.
- *Advancement in user-friendly options.* According to the WHO, the current recommended PEP regimens against rabies infection are the Essen and the Zagreb schedule, and WHO has a task that prioritizes the reduction of the duration and number of doses administered under those regimens. As such, more user-friendly rabies vaccines featuring shorter duration and smaller number of doses are likely to lead the future development of rabies vaccines.
- *Growing demand from people with immunocompromised conditions.* There is a growing population with immunocompromised conditions such as those caused by or associated with chronic diseases, medical treatment, transplants, smoking, obesity and aging. Such population is likely to have inadequate antibody responses to the current rabies vaccines, which necessitates the development of novel, appropriate vaccines.

### ***Competitive landscape of China's rabies vaccine market***

According to the NMPA and the F&S Report, there were 15 marketed human rabies vaccine products in China as of July 31, 2022. China's human rabies vaccine market is highly concentrated, with the top four manufacturers, including Chengda Biotechnology, Rongan Biological Products, Changchun Zhuoyi, and YS Group, representing a combined market share of 82.7% in terms of lot release in 2021. YS Group started to sell YSJA™ rabies vaccines in October 2020, representing 3.2% of China's rabies vaccine market in terms of lot release in the full year of 2020, Its vaccine sales increased to 8.1% in terms of lot release and 7.2% in terms of production value in the calendar year 2021. According to the CDE and the F&S Report, there were nine human rabies vaccine candidates in China as of December 31, 2021. The following table sets forth the marketed human rabies vaccines based on Vero cell technology in China according to the 2021 lot release results.

Company	Products	Cell line	Specifications	Dose regimen	Median bidding price (unit: RMB)
YS Biopharma	Freeze-dried Human Rabies Vaccine	Vero cell	0.5ml per dose after reconstitution	Essen five-dose	95.0
Chengda Biotechnology	Freeze-dried Human Rabies Vaccine/Human Rabies Vaccine	Vero cell	0.5ml per dose after reconstitution	Zagreb four-dose & Essen five-dose	104.0
Rongan Biological Products	Freeze-dried Human Rabies Vaccine	Vero cell	1.0ml per dose after reconstitution	Essen five-dose	81.9
Chengdu Kanghua Biological Products	Freeze-dried Human Rabies Vaccine	Human diploid cell	1.0ml per dose after reconstitution	Essen five-dose	310.0
Zhongke Biopharma	Human Rabies Vaccine	PHKC	1.0ml per dose	Essen five-dose	95.0
Yuanda Biopharma	Human Rabies Vaccine	PHKC	1.0ml per dose	Essen five-dose	79.0
Changchun Zhuoyi	Freeze-dried Human Rabies Vaccine	Vero cell	0.5 ml per dose after reconstitution	Essen five-dose	87.0
Aleph Bio	Human Rabies Vaccine	Vero cell	1.0 ml per dose	Essen five-dose	83.0
Changchun Institute of Biological Products	Freeze-dried Human Rabies Vaccine	Vero cell	0.5 ml per dose after reconstitution	Zagreb four-dose & Essen five-dose	94.5

Source: NMPA, Frost & Sullivan analysis

### Human Rabies Vaccine Market in Select Southeast Asian Countries

According to the F&S Report and expert interviews, the aggregate market size of rabies vaccine in the Philippines, Vietnam, Malaysia and Singapore in terms of sales revenue increased from \$6.4 million in 2017 to \$18.1 million in 2021, at a CAGR 29.5%, and is expected to increase to \$45.0 million in 2025, at a CAGR of 25.6% from 2021 to 2025, and further to \$89.9 million in 2030, at a CAGR of 14.8% from 2025 to 2030. The following table sets forth the marketed rabies vaccines based on Vero cell technology in those countries as of July 31, 2022.

#### Rabies Vaccine Approved in Singapore

Product Name	Company	Cell Type
Verorab®	Sanofi	Vero cell
Rabipur®	Novartis	Purified chick embryo cell

#### Rabies Vaccine Approved in Malaysia

Product Name	Company	Cell Type
Verorab®	Sanofi	Vero cell

#### Rabies Vaccine Approved in Vietnam

Product Name	Company	Cell Type
Verorab®	Sanofi	Vero cell
Rabipur®	Novartis	Purified chick embryo cell
Indirab®	Bharat Biotech	Vero cell
Speeda®	Liaoning Chengda	Vero cell

Note: As of July 31, 2022

Source: Government website, Frost & Sullivan analysis

### Rabies Vaccine Approved in Philippine

Product Name	Company	Cell Type
Rabivax-S®	Serum Institute Of India	Vero cell
Verorab®	Sanofi	Vero cell
Rabipur®	Novartis	Purified chick embryo cell
Abhayrab®	Indian Immunologicals	Vero cell
Indirab®	Bharat Biotech	Vero cell
Speeda®	Liaoning Chengda	Vero cell
Vaxirab N®	Cadila Healthcare	Purified chick embryo cell
Bioshoot®	Changchun Zhuoyi	Vero cell

Note: As of July 31, 2022

Source: Government website, Frost & Sullivan analysis

According to the F&S Report, dog bites are common in Southeast Asia, and Southeast Asian countries expend substantial funds on human rabies biologics annually. In Philippines, 815,902 dog-biting cases were reported and 276 victims died of rabies infection in 2018. In Vietnam, more than 350,000 people were bitten by dogs and cats while more than 80 human deaths were reported in 2018. While Singapore is recognized as rabies-free and Malaysia has almost realized rabies-free, rabies vaccine market still exists in those countries. In particular, when faced with the deadly rabies virus, people may still opt to be administered with human rabies vaccines after being bitten by animals to ensure life safety and health. All mammals, including cats and bats, are susceptible to infection with rabies virus, although only a few species are recognized as important for the persistence of the disease and attainment of rabies-free status. In addition, people traveling to other countries with a high risk of rabies infection also need to be vaccinated, which supports the market size of human rabies vaccines.

To compete effectively in the Southeast Asian markets and quickly capture the local demand, YS Group plans to implement its clinical trial plan for rabies vaccines in Southeast Asian countries, construct manufacturing plant in Singapore, and collaborate with local partners for product registration, sales and marketing. See the section entitled “YS Group’s Business — YS Group’s Strategies — Pursue integrated global growth strategy through international collaborations and partnerships.”

### Covid-19 Vaccine Market

#### Overview and impact of COVID-19

COVID-19 is the infectious disease caused by the most recently discovered coronavirus. Coronaviruses are a large family of viruses which may cause illness in animals or humans, which are widely distributed in many different species of animals, including bats, cattle, cats, birds, and camels. They are also one of the pathogens that causes respiratory tract infection in human. According to a study from John Hopkins University and the F&S Report, herd immunity of COVID-19 could be achieved when 70% to 90% of the population acquire immunity. Assuming that an individual needs an average of two doses of COVID-19 vaccine to achieve immunity, a corresponding total of 10.5 to 13.5 billion doses and 2.0 to 2.5 billion doses of COVID-19 vaccines are required to achieve herd immunity globally and in China, respectively. The global economy could suffer between \$5.8 trillion and \$8.8 trillion in losses, equivalent to 6.4% to 9.7% of global GDP, as a result of the COVID-19 pandemic.

According to the F&S Report, COVID-19 could co-exist with humans for a long period of time because it is more adaptive to the host and less virulent than other viruses such as Severe Acute Respiratory Syndrome (“SARS”). To lower the mortality of COVID-19 patients, the government around the globe are willing to procure and/or reimburse for COVID-19 vaccines. In addition, COVID-19 might significantly change people’s attitude towards infectious diseases, leading to the increase in the detection rate of infectious diseases and driving the growth of vaccines and other anti-infective drugs. According to the Technical Guideline for the Research and Development of COVID-19 Prophylactic Vaccine (Tentative) issued by the CDE in August 2020, in response to the COVID-19 pandemic, on condition that the safety of participants could be protected, a

flexible trial design under which as much information and data as possible is obtained may be adopted to shorten the clinical trial period and accelerate the clinical research process. COVID-19 vaccines will be offered for free for Chinese residents, the cost of which will be covered by the government's fund. Vaccine manufacturers may price their product based on the cost of production and product attributes. Relevant government departments will follow the corresponding procurement procedures to purchase from vaccine manufacturers.

#### ***Challenges and future trends of COVID-19 vaccine market***

There are certain challenges associated with the development of COVID-19 vaccines. First, early phase clinical trials on COVID-19 vaccines rely on antibody titers to test immunogenicity, which is not a conclusive indicator for vaccine efficacy. Large-scale Phase III trials are the only way to prove effective protection. Second, the manufacturing of COVID-19 vaccines involves unproven technology platforms and extra capacity, which increased the related manufacturing risks. Third, simulation experiments have revealed that to prevent an epidemic, the efficacy of a vaccine must be at least 60% when vaccination coverage is 100%. However, the adoption of COVID-19 vaccine is still at a relatively nascent stage.

There are a few trends associated with the future development and the market of COVID-19, according to the F&S Report. First, the potential of different types of COVID-19 vaccines based on diverse technology, such as mRNA-based, DNA-based and protein-based vaccines could be further explored. Second, vaccines of improved efficacy and safety might be developed and launched. Future COVID-19 vaccines might be optimally designed to maximize immunogenicity and exclude unnecessary or even harmful protein domains. In addition, more accurate measurement of the efficacy might be developed to align with the advancement in efficacy. Vaccines suitable for immunocompromised people and/or providing long-term safety will continue to be discovered and developed. Furthermore, it remains unclear whether the vaccines developed so far are able to prevent people from acquiring mild infections that could be passed on to others, and the duration of immunity to COVID-19 rendered by vaccines.

#### ***Competitive landscape of global COVID-19 vaccine market***

According to the WHO and the F&S Report, there were a total of 70 COVID-19 vaccine products and product candidates in clinical Phase III and above as of July 31, 2022. The following table sets forth the current primary COVID-19 vaccine products.

COVID-19 Vaccine developer/manufacturer	Vaccine platform	Type of candidate vaccine	Status / Clinical Phase <sup>1</sup>	Doses <sup>2</sup>
Moderna/NIAID	RNA	LNP-encapsulated mRNA	FDA approval/WHO issued emergency use listing	2
BioNTech/Fosun Pharma/Pfizer	RNA	3 LNP-mRNAs	FDA approval/WHO issued emergency use listing	2
Beijing Institute of Biological Products/Sinopharm	Inactivated	Inactivated	NMPA conditional approval/WHO issued emergency use listing	2
University of Oxford/AstraZeneca	Non-Replicating Viral Vector	ChAdOx1-S	WHO issued emergency use listing	2
Sinovac	Inactivated	Inactivated	NMPA conditional approval/WHO issued emergency use listing	2
CanSino/Beijing Institute of Biotechnology	Non-Replicating Viral Vector	Adenovirus Type 5 Vector	NMPA conditional approval/WHO issued emergency use listing	1
Wuhan Institute of Biological Products/Sinopharm	Inactivated	Inactivated	NMPA conditional approval	2
Janssen Pharmaceutical	Non-Replicating Viral Vector	Ad26.COV2.S	FDA issued an emergency use authorization/WHO issued emergency use listing	1
Anhui Zhifei Longcom	Protein Subunit	Protein Subunit	NMPA conditional approval	3
Shenzhen Kangtai Biological	Inactivated	Inactivated	NMPA conditional approval	3
Serum Institute of India (Novavax formulation)	Protein Subunit	Protein Subunit	WHO issued emergency use listing	2
Novavax	Protein Subunit	Protein Subunit	FDA issued an emergency use authorization/WHO issued emergency use listing	2
Serum Institute of India (Oxford/AstraZeneca formulation)	Non-Replicating Viral Vector	ChAdOx1-S	WHO issued emergency use listing	2
Bharat Biotech	Inactivated	Inactivated	WHO issued emergency use listing	2

Note: COVID-19 vaccine, in China approved for emergency use are not included.

1. Only FDA, NMPA and WHO issued vaccine approval is displayed.

2. Doses required for each product in clinical phase are based on the clinical information exhibited in public sources. As of July 31, 2022

Source: WHO, Clinicaltrials.gov, Frost & Sullivan analysis

## Immuno-Oncology Market

### Overview

Immuno-oncology therapy is designed to stimulate the patient's own immune system to generate or augment an antitumor immune response to control or eradicate cancer cells. Due to its ability to provide durable remissions while being generally well-tolerated in certain patients with advanced cancers, immuno-oncology therapy marks a milestone in cancer treatment in recent years. Major types of immuno-oncology therapies include cellular immunotherapies, checkpoint inhibitors, therapeutic cancer vaccines and cytokines.

China's immuno-oncology therapies market has grown substantially in recent years, and the momentum is expected to continue to grow. According to the F&S Report, China's immuno-oncology therapies market grew from RMB0.9 billion in 2017 to RMB16.3 billion in 2021, at a CAGR of 108.2%, and is expected to grow to RMB63.8 billion in 2025, at a CAGR of 40.6% from 2021 to 2025, and further to RMB256.4 billion, at a CAGR of 32.1% from 2025 to 2030.

Due to factors such as alcohol abuse, HBV and hepatitis C virus infections, the incidence of hepatocellular cancer in China increased from approximately 351,100 in 2017 to 388,000 in 2021, at a CAGR of 2.5%, and is expected to reach approximately 427,500 in 2025, at a CAGR of 2.5% from 2021 to 2025 and 474,200 in 2030, at a CAGR of 2.1% from 2025 to 2030, according to the F&S Report. The hepatocellular drug market, in terms of sales revenue, increased from RMB3.6 billion in 2017 to RMB8.9 billion in 2021, at a CAGR of 25.4%, and is expected to reach RMB23.8 billion in 2025, at a CAGR of 27.9% from 2021 to 2025 and

RMB43.1 billion in 2030, at a CAGR of 12.6% from 2025 to 2030, according to expert interviews and the F&S Report. The incidence of pancreatic cancer in China increased from approximately 101,500 in 2017 to approximately 115,900 in 2021, at a CAGR of 3.4%, and is expected to reach approximately 133,100 in 2025, at a CAGR of 3.5% from 2021 to 2025 and 155,800 in 2030, at a CAGR of 3.2% from 2025 to 2030. The pancreatic cancer drug market, in terms of sales revenue, increased from RMB2.4 billion in 2017 to RMB3.0 billion in 2021, at a CAGR of 6.5%, and is expected to reach RMB7.0 billion in 2025, at a CAGR of 23.1% between 2021 to 2025 and RMB11.8 billion in 2030, at a CAGR of 11.1% between 2025 to 2030, according to the same source.

### ***Growth Drivers of China's Immuno-Oncology Market***

The primary market drivers of China's immuno-oncology market include:

- *Unmet clinical demand of cancer patients.* Due to the rapid increase in the incidence of cancer and limitations of existing treatments, there is significant unmet demand of cancer patients for immuno-oncology therapies. Although a number of immunosuppressant and chimeric antigen receptor T-cell (CAR-T). CAR-T products have been approved successively, there are still problems associated with such products, which calls for the continuous development of safe and more effective therapies.
- *Expansion of indications.* Although there have been six PD-1 monoclonal antibodies (mAbs) launched in China, only eight indications have been approved by the end of 2020. By the end of 2020, the U.S. FDA had approved 19 indications for PD-1 mAbs, which suggests great potential of the expansion of indications in China and thus the development of the immune-oncology market.
- *Rapid development of new-generation therapies.* Benefiting from the regulatory approval of CTLA-4 inhibitor in 2011, the development of immuno-oncology therapeutics has experienced significant progress. Immuno-oncology has become a sub-specialty under oncology due to its unique scientific nature and its potential for substantial, long-term clinical advantages. Since immunotherapy agents mobilizes the immune system, immuno-oncology drug may encompass a broad range of agents with great potential.
- *Favorable policies.* Chinese government is implementing favorable policies to promote the development of new immune-oncology therapies. Special review channels also accelerate the marketing of anti-tumor drugs with outstanding therapeutic advantages in China. In addition, policies such as the expansion of medical insurance, zero tariff on imported anticancer drugs, and coverage of anticancer drugs under NRDL will reduce the cost of anticancer drugs, which will drive the growth of China's immune-oncology market.

### ***Competitive Landscape of the Immuno-oncology Therapeutics Targeting TLR3/MDA5/RIG-I***

According to the F&S Report, there are six immune-oncology therapeutics targeting TLR3/MDA5/RIG-I under development globally as of July 31, 2022, and there is no such therapeutic under development in China. The following table sets forth the pipeline information of the candidates.

Product <sup>1</sup>	Drug Type	Company	Phase	Target	Indications <sup>2</sup>	Trial Sites	First Posted Date
Hiltonol/Poly-ICLC	Double stranded RNA complex	Oncovir	II	TLR3/MDA5	AML, Astrocytoma, Breast Cancer, Bladder Cancer, BT, CC, CIN, CMML, CNS Tumor, CRC, FLC, FL-HCCFTC, Glioma, HNCKC, Low-Grade B-cell Lymphoma, MCC, MDS, MPM, NHL, NMSC, NSCLC, OC, Oligo-Astrocytoma, Pancreatic Cancer, Prostate Cancer, PPC, RC, Sarcoma, OCSCC, SMM, TC, UC, Myelofibrosis, Melanoma	Canada, US, UK, Spain, Russian, Hungary, Ukraine, Germany, Switzerland, Netherlands, Denmark	2015/1/8
Ampligen/Rintatolimod	RNA	AIM ImmunoTech	II	TLR-3	BC, OC, Prostate Cancer	US	2019/4/2
BO-112	Synthetic dsRNA complex	Highlight Therapeutics	II	TLR3/MDA5/RIG-I	CRC, Melanoma, GC, Oesophageal Cancer	Spain, Belgium, Italy	2020/8/11
CV-8102	RNA-based adjuvant	CureVac	I/II	TLR7/8/RIG-1	HCC, Melanoma, SCC of the Skin Carcinoma, HNSCC, Adenoid Cystic	Austrial, France, Germany, Spain, UK	2017/6/29
EG-70	non-viral gene therapy encoding RIG-I agonists	enGene	I/II	RIG-I	Bladder cancer	US	2021/2/12
YS-ON-001	Multiple component complex of proteins	YS Biopharma	I	TLR3/MDA5/RIG-I	Cancer	Singapore	2017/4/27

Note: Pipeline information as of July 31, 2022. Only systemic drugs for the treatment of cancer.

AML=Acute Myeloid Leukemia, CC=Colon Cancer, CIN=Cervical Intraepithelial Neoplasia, CMML=Chronic Myelomonocytic Leukemia, CRC=Colorectal Cancer, FL-HCC=Fibrolamellar Hepatocellular Carcinoma, FTC=Fallopian Tube Carcinoma, GC=Gastric

*Cancer, HCC=Hepatocellular Carcinoma, HNC=Head and Neck Cancer, HNSCC=Head and Neck Squamous Cell Carcinoma, KC=Kidney Cancer, MCC=Merkel Cell Carcinoma, MDS=Myelodysplastic Syndrome, MPM=Malignant Pleural Mesothelioma, NHL=Non-Hodgkin's Lymphoma, NMSC=Non-Melanoma Skin Cancers, OC=Ovarian Cancer, OSCC=Oral Cavity Squamous Cell Carcinoma, PPC=Primary Peritoneal Carcinoma, RC=Renal Cancer, SCC=Squamous Cell Carcinoma, SMM=Smoldering Multiple Myeloma, TC=Testicular Cancer, UC=Urothelial Cancer*

*Source: Clinicaltrials.gov, Frost & Sullivan analysis*

## **Hepatitis B Vaccines Market**

### **Overview**

Hepatitis B is an infectious disease caused by hepatitis B virus (“HBV”) and characterized by inflammation of the liver. HBV infections may be acute, short-term or chronic, with children infected with HBV prone to chronic hepatitis. Chronic HBV can cause serious health issues, such as cirrhosis, liver failure, liver cancer, or hepatocellular cancer. According to the F&S Report, the diagnosis and treatment rate in China is relatively low at 32.1% and 21.1% in 2019, respectively, mainly due to low public awareness of the disease, massive patients pool and lack of diagnosis capacity in remote areas. Lot release of hepatitis B prophylactic vaccine has reached 70.7 million in 2021, at a CAGR of -3.3%, and is expected to reach 85.4 million in 2025, at a CAGR of 4.9% from 2021 to 2025, and further to 90.8 million in 2030 at a CAGR of 1.2% from 2025 to 2030, according to the same source.

There are mainly four categories of HBV antiviral drugs in China, recombinant cytokine gene-derived protein, polypeptide, nucleoside analogue and interferon, none of which is individually sufficient to achieve functional cure of HBV and cannot meet the medical needs for HBV therapies. While prophylactic vaccines are ineffective in treating infected HBV patients, there is an emerging pipeline of therapeutic vaccine candidates for treating chronic HBV based on different platforms, which have the potential to enhance the efficacy of current antiviral therapies through strong adaptive and innate immune responses.

### ***Growth drivers of China's hepatitis B prophylactic vaccine market***

The primary growth drivers of China's hepatitis B prophylactic vaccine market include:

- *Favorable government policies for hepatitis B prophylactic vaccines.* Due to the large population base, the deep pool of existing infected patients, and the low penetration of diagnosis and treatment, China has the heaviest hepatitis B infection burden in the world and still faces considerable challenges to meet the WHO's target to eliminate viral hepatitis as a major public health threat by 2030. Therefore, spreading vaccination among newborns is still an important domestic agenda with the support of government funds.
- *Demand from non-responders to previous vaccines.* A hepatitis B vaccine non-responder refers to one who does not develop protective surface antibodies after completing two full series of the vaccine and for whom an acute or chronic hepatitis B infection has been eliminated. Approximately five to 15 percent of the population may be non-responders due to aging, obesity, smoking, and other chronic illness, which requires the development of vaccines to protect such group.
- *Simplified vaccination and better efficacy.* The conventional hepatitis B vaccines are administered in three doses, failure of which may reduce effectiveness. A two-dose regimen has the potential to improve adherence and also provide greater seroprotection, which simplifies the vaccination regimen and improves efficacy.

### ***Growth drivers of China's HBV treatment market***

The primary growth drivers of China's HBV treatment market include:

- *Improving diagnosis and treatment rate.* The rapid increase in healthcare spending in China has led to significant improvement in the primary medical institutions' diagnosis capacity and diagnosis rate of HBV patients in rural area. With the increasing public awareness of HBV, more patients are likely to seek treatment, which drives the market growth.
- *Government support.* All marketed hepatitis B antiviral drugs in China had entered the National Reimbursement Drug List as of December 31, 2020, which will markedly improve the penetration of such drugs in China. Moreover, Chinese government is making significant efforts to achieve functional cure of



HBV. Therefore, innovative HBV drugs such as therapeutic vaccines are likely to enter the National Reimbursement Drug List and receive large-scale government support.

- *Huge unmet demand for functional cure.* HBV Treatment currently available in China does not affect the transcriptional activity of covalently closed circular DNA or viral protein production and thus cannot afford functional cure. Therefore, there is a significant unmet demand for treatment providing functional cure, which will free HBV patients from taking antiviral drugs and significantly lower the risk of inflicting liver cirrhosis and liver cancer.

#### *Competitive landscape of China's hepatitis B vaccine market*

According to the NMPA and the F&S Report, there were nine marketed hepatitis B prophylactic vaccine products in China as of July 31, 2022.

Company	Products	Cell line	Specifications	Regimen
Lanzhou Institute of Biological Products	Recombinant Hepatitis B Vaccine	CHO	20µg/1.0ml, 10µg/1.0ml	3-dose schedule (0, 1, 6 months)
Beijing Yadong Biological Pharmacy	Recombinant Hepatitis B Vaccine	CHO	10µg/0.5ml, 20µg/1.0ml	3-dose schedule (0, 1, 6 months)
Wuhan Institute Of Biological Products	Recombinant Hepatitis B Vaccine	CHO	10µg/1.0ml	3-dose schedule (0, 1, 6 months)
North China Pharmaceutical Group	Recombinant Hepatitis B Vaccine	CHO	20µg/1.0ml, 10µg/0.5ml	3-dose schedule (0, 1, 6 months)
Aimei Hissen Vaccine (Dalian)	Recombinant Hepatitis B Vaccine	Hansenula polymorpha	10µg/0.5ml, 20µg/0.5ml	3-dose schedule (0, 1, 6 months)
Shenzhen Kangtai Biological Products	Recombinant Hepatitis B Vaccine	Saccharomyces	60µg/1.0ml, 10µg/0.5ml, 20µg/1.0ml	1-dose on day 0, 3-dose schedule (0, 1, 6 months)
Hualan Biological Vaccines	Recombinant Hepatitis B Vaccine	Hansenula polymorpha	10µg/0.5ml	3-dose schedule (0, 1, 6 months)
Beijing Institute of Biological Products	Recombinant Hepatitis B Vaccine	Saccharomyces	20µg/1.0ml, 10µg/0.5ml	3-dose schedule (0, 1, 6 months)
GSK	Recombinant Hepatitis B Vaccine	Saccharomyces	10µg/0.5ml, 20µg/1.0ml	3-dose schedule (0, 1, 6 months) or 4-dose schedule (0, 1, 2, 12 months)

Source: NMPA, Frost & Sullivan analysis

According to the CDE and the F&S Report, there are five hepatitis B prophylactic vaccine pipelines in China as of July 31, 2022. The following table sets forth the current primary candidates in China.

	Company	Cell line	Phase	Specifications	Dose regimen	First Posted Date
Recombinant Hepatitis B Vaccine	Hualan Biological Vaccines	Hansenula polymorpha	III	10µg/0.5ml	3-dose schedule (0, 1, 6 months), newborns should be injected within 24 hours	2014-01-10
				20µg/1.0ml	3-dose schedule (0, 1, 6 months)	2014-09-05
Recombinant Hepatitis B Vaccine	Walvax Biotechnology	Hansenula polymorpha	III	20µg/0.5ml	3-dose schedule (0, 1, 6 months)	2014-04-03
Recombinant Hepatitis B Vaccine	Beijing Minhai Biotechnology	Hansenula polymorpha	I	20µg/1.0ml	NA	2013-09-18
Recombinant Hepatitis B Vaccine	Chengdu Institute Of Biological Products	Pichia pastoris	I	10µg/0.5ml 20µg/1.0ml	3-dose schedule (0, 1, 6 months)	2016-10-17
Recombinant Hepatitis B Vaccine	Sinovac Research & Development	Hansenula polymorpha	I	10µg/0.5ml	3-dose schedule (0, 1, 6 months)	2019-07-02
				20µg/1.0ml	3-dose schedule (0, 1, 6 months)	2020-01-08

Source: CDE, Frost & Sullivan analysis

According to the CDE and F&S Report, there were six HBV therapeutic vaccine candidates in China as of July 31, 2022, as set forth in the following table.

Competitive landscape of therapeutic vaccines for HBV in China				
Vaccine Name	Company	First Posted Date	Phase	Platform
Therapeutic Hepatitis B Vaccine (YIC)	Beijing Institute of Biological Products	2014-05-07	III	Antigen-antibody complex
Therapeutic Hepatitis B Vaccine (synthetic peptide vaccine)	Jiangsu Mendel Gene Technology	2021-04-14	III	synthetic peptide
Therapeutic dual-plasmid HBV DNA Vaccine	Guangzhou Baidi Biology Medical Company	2017-09-29	Ib	DNA
T101 (TG1050)	Tasly Biopharma	2019-12-02	II	Live vector (Ad5)
BR11-179 (VBI-2601)	Brii Biosciences	2020-04-21	Ib/Ila	Protein
TVAX-008	Jiangsu Theravac Biopharmaceutical	2020-12-24	I	Protein

*Note: As of July 31, 2022, according to literature analysis, the development of HBV therapeutic vaccine was still in progress. There is no HBV therapeutic vaccine on the market in China.*

*Source: CDE, Frost & Sullivan analysis*

There were no HBV therapeutic vaccine products approved in China as of July 31, 2022, according to the F&S Report. HBV therapeutic vaccine is expected to appear on China's market in 2024, and with such, China HBV therapeutic vaccine market is expected to be RMB1.2 billion in 2024 and increase to RMB23.2 billion in 2030, at CAGR of 63.1% from 2024 to 2030, according to the F&S Report.

#### Source of Information

This section includes information from the F&S Report, a report commissioned by YS Biopharma, as it believes such information imparts a greater understanding of the industry. Frost & Sullivan is a global consulting company and an independent third party founded in 1961. Figures and statistics provided in this proxy statement/prospectus and attributed to Frost & Sullivan or the F&S Report have been extracted from the F&S Report and published with the consent of Frost & Sullivan.

In preparing the F&S Report, Frost & Sullivan conducted detailed primary research which involved conducting interviews with industry insiders including leading industry participants and industry experts, and secondary research which involved reviewing company reports, independent research reports and data based on Frost & Sullivan's own research database. Frost & Sullivan also assumed that (1) China's economy is likely to maintain its steady growth in the next decade, (2) China's social, economic, and political environment are likely to remain stable in the forecast period, and (3) relevant market drivers are expected to drive the growth of relevant markets in the forecast period.

## YS GROUP'S BUSINESS

### Overview

YS Group is a global biopharmaceutical company dedicated to discovering, developing, manufacturing and commercializing new generations of vaccines and therapeutic biologics for infectious diseases and cancer.

YS Group commercializes vaccines with significant revenue and growth potential. YS Group takes pride in its marketed vaccine product, YSJA™ rabies vaccine, which was the first aluminum-free lyophilized rabies vaccine launched in China. YSJA™ rabies vaccine significantly improves the suitability of human rabies vaccine to rabies in China and causes less pain, injection site discomfort and fever to patients compared with certain other rabies vaccines in China. In addition, YSJA™ rabies vaccine is suitable for mass production and commercialization with long shelf life and low risk to contamination. As of the date of this proxy statement/prospectus, approximately 97 million doses of YSJA™ rabies vaccine have been administered for post-exposure protection against rabies. With YS Group's track record of commercialization, YSJA™ rabies vaccine has achieved high production scalability and wide market recognition. Since YS Group launched its production at its current GMP-compliant facilities in February 2020 and as of September 30, 2022, YS Group had sold more than 16 million doses of YSJA™ rabies vaccines to approximately 1,625 county-level CDCs in China.

In addition to the commercialized YSJA™ rabies vaccine, YS Group also has a pipeline of vaccine candidates powered by YS Group's proprietary PIKA immunomodulating technology platform. YS Group's proprietary PIKA immunomodulating technology platform is core to the discovery and development of innovative biologics and will continue to be instrumental to YS Group's success. As of the date of this proxy statement/prospectus, YS Group has a robust portfolio of seven innovative product candidates: (1) four product candidates under various clinical development stages, including PIKA rabies vaccine, PIKA recombinant COVID-19 vaccine, PIKA YS-ON-001 and PIKA YS-HBV-001, and (2) four preclinical stage product candidates, targeting HBV, influenza and cancer with enormous medical demand. In addition, YS Group is working on a series of therapeutic targets, rabies and products at the discovery stage. YS Group has been granted about 70 patents across more than 30 countries and regions relating to its PIKA immunomodulating technology and prophylactic and therapeutic product innovations. YS Group believes that its PIKA immunomodulating technology platform has the potential to nurture a wide variety of innovative vaccines and therapeutic biologics.

YS Group's next-generation product candidate, PIKA rabies vaccine is a premium rabies vaccine candidate that features accelerated seven-day regimen, fast seroconversion and broad protection against multiple virus strains. YS Group completed Phase I and Phase II clinical trial of PIKA rabies vaccine in Singapore in February 2016 and July 2016, respectively, and completed Phase I study of PIKA rabies vaccine in China in 2021 with preliminary results which confirmed the dose, regimen and safety observed from the Singapore trials. The Phase I and II clinical studies to date have shown that PIKA rabies vaccine can be used under an accelerated regimen, which achieves a protective level of neutralizing antibodies as early as seven days post vaccination and elicit more robust immunogenic response compared to that of the control arm vaccine, which is a widely used commercially available vaccine. YS Group believes that PIKA rabies vaccine has the potential to elevate the standard of care in human rabies prevention and treatment paradigms.

YS Group is also currently developing both injectable and nebulized formulations for PIKA recombinant COVID-19 vaccine. PIKA recombinant COVID-19 vaccine is composed of a PIKA adjuvant and trimeric recombinant full-length, wild-type SARS-CoV-2 spike glycoprotein optimized in the established CHO expression system. YS Group completed Phase I trial of PIKA recombinant COVID-19 vaccine in the UAE in the first half of 2022, and the preliminary results showed that as basic immunization and sequential booster immunization, PIKA recombinant COVID-19 vaccines can induce the production of high-level neutralizing antibodies, which are effective for a variety of mutant strains, including Delta, Omicron sublineages BA.1, BA.2, BA.3, BA.4/5 and BA.2.12.1. In November 2022, YS Group obtained the clearance of Investigational New Drug Application ("IND") for PIKA recombinant COVID-19 vaccine from FDA in the United States. YS Group has completed the enrollment of the multi-center multiple country Phase II/III studies in Philippines and UAE.

YS Group has been manufacturing YSJA™ rabies vaccine and clinical trial materials in its current GMP-compliant facilities. YS Group has also obtained patents in relation to its manufacturing techniques and devices. YS Group's current manufacturing facilities have an annual production capacity of approximately 15 million doses of YSJA™ rabies vaccine as production in February 2020. As of September 30, 2022, YS Group had manufactured approximately 26 million doses of YSJA™ rabies vaccine. YS Group has established a comprehensive and highly effective commercialization infrastructure, underpinned by its experienced in-house commercialization team and professional service providers. As of September 30, 2022, YS Group's in-house commercialization team diligently managed its sales and marketing activities across approximately 336 cities in China. YS Group believes that its product candidates, if approved and launched, will benefit from the operating leverage enabled by YS Group's accumulated commercialization experience and scalable commercialization infrastructure to achieve market success.

### **Competitive Strengths**

YS Group believes the following competitive strengths contribute to its success and distinguish YS Group from its competitors.

#### ***Marketed YSJA™ rabies vaccine with track record of commercialization and significant revenue potential***

YS Group is a biopharmaceutical company with innovative technology and a revenue-generating marketed product with growth potential. YSJA™ rabies vaccine is the first aluminum-free lyophilized rabies vaccine launched in China, according to the F&S Report, and approximately 97 million doses have been administered to patients for post-exposure protection against rabies. According to the F&S Report, the market production value of China's human rabies vaccine market was approximately RMB9.4 billion in 2021. According to the same source, human rabies vaccine is ranked as one of the top five vaccine categories in China in 2020 in terms of market production value. With YS Group's track record of commercialization, YSJA™ rabies vaccine has achieved high production scalability and wide market recognition. In the two fiscal years ended March 31, 2022 and the six months ended September 30, 2022, YS Group had sold more than 16 million doses to approximately 1,625 county-level CDCs in China.

YSJA™ rabies vaccine has demonstrated critical advantages in product characteristics and manufacturing, which makes it attractive for commercialization. YSJA™ rabies vaccine significantly improved the suitability of human rabies vaccine to rabies in China by adopting fixed CTN-1 strain to produce vaccine in Vero cells. The homology between CTN-1 strain and most wild Chinese rabies isolates is between 81.5% to 93.4%, much higher than PM-1 strain used in other licensed vaccines, according to sequence analysis. YSJA™ rabies vaccine is administered in half of the injection volume of some other rabies vaccines, which causes less pain, injection site discomfort and fever to patients compared with such other rabies vaccines. Developed with Vero cell technology, YSJA™ rabies vaccine is ideal for mass production with low risk of exogenous contamination. In addition, it is in freeze-dried form, which makes it easier to store and transport and less susceptible to changes in temperature, thereby providing longer shelf-life and reducing potential product spoilage. In the two fiscal years ended March 31, 2022 and the six months ended September 30, 2022, YS Group had manufactured approximately 26 million doses of YSJA™ rabies vaccine.

As an early entrant in the rabies vaccine industry with a marketed product and an established distribution network, YS Group is well-positioned to capture the fast-growing and vast market in China. According to the F&S Report, the market production value of human rabies vaccine in China is expected to increase from RMB9.4 billion in 2021 to RMB22.1 billion in 2025, at a CAGR of 23.8%, and further to RMB33.3 billion in 2030, at a CAGR of 8.5% from 2025 to 2030. YS Group also actively explores opportunities for strategic collaboration and product licensing with leading pharmaceutical companies and investment funds to expand its commercial returns and global presence.

#### ***Next-generation product candidate, PIKA rabies vaccine, with accelerated regimen and broad protection against multiple virus strains leads to potentially elevated standard of care and favorable and promising market outlook***

YS Group is developing its next-generation product candidate, PIKA rabies vaccine, featuring accelerated regimen and broad protection against multiple virus strains. According to a study by the Guangxi Center for Disease Control and Prevention in China, 78.1% of the failure cases of rabies vaccine occurred from day 6 to day 27 post vaccination. Therefore, faster seroconversion is clinically meaningful. In vaccine immunology,

seroconversion signifies the development of specific antibodies in the blood serum as a result of immunization, including vaccination. During seroconversion, the antibody is present but not yet detectable. After seroconversion, the antibody is detectable by standard techniques and could remain detectable for certain period. Determining seroconversion can be important for understanding the immune response, infection rates, and identification of potential serum donors. Seroconversion rates are one of the methods used for determining the efficacy of a vaccine. The higher the rate of seroconversion, the more potentially protective the vaccine for a greater proportion of the population although seroconversion does not inherently confer immunity or resistance to infection. In the case of rabies vaccine, seroconversion was assessed by the serum rabies virus neutralizing antibody (RVNA) titer at pre-defined date post vaccination, and RVNA titer can be determined by the fluorescent antibody virus neutralization (FAVN) test. As for the protection of rabies vaccines, a minimum level of 0.5 IU/mL of the serum RVNA titer is used by the WHO as a correlate of protection. Given that most of recipients of rabies vaccine only seek vaccination post the animal attack or under post-exposure scenario, there is potential exposure of virus infection risk when they are seeking or during the course of vaccination. Therefore, the fast seroconversion also means the earlier protective level of rabies virus neutralizing antibody achieved, which is very meaningful in reducing the virus infection risk. The clinical studies to date have shown that PIKA rabies vaccine can be used under an accelerated regimen, which achieves protective level of RVNA against multiple virus strains as early as seven days post vaccination and elicit more robust immunogenic response compared to that of the control arm vaccine, which is a widely used commercially available vaccine. According to the F&S Report, PIKA rabies vaccine has reported the highest seroconversion rate on day 7 among all candidates with published clinical data based on non head-to-head studies in China so far. Although YS Group conducted head-to-head studies in Singapore, such comparison with other candidates in China was not based on head-to-head studies, YS Biopharma cannot guarantee that similar results would be obtained if additional head-to-head studies are conducted in the future. YS Group believes PIKA rabies vaccine has the potential to elevate the standard of care for rabies vaccine in China and other emerging markets, such as certain Southeast Asian and African countries.

With no overt toxicities from animal studies and no vaccine-related serious adverse events in clinical trials to date, YS Group believes that PIKA rabies vaccine has the potential to elevate the standard of care in human rabies prevention and treatment paradigms. PIKA rabies vaccine's accelerated onset of immune responses allows a three-visit one-week regimen, superior to the currently available vaccine with a five-visit one-month or three-visit three-week regimen, and significantly accelerates generation of immunization from 28 days to seven days, which has the potential of becoming the first accelerated one-week regimen upon the completion of the NDA, according to the F&S Report. Based on the clinical trials to date, PIKA rabies vaccine also has a distinct role in promoting cellular, humoral and innate immunity in the type of immune response and thus has the dual character of both a prophylactic and a therapeutic vaccine. PIKA rabies vaccine can quickly induce the production of a variety of chemokines and cytokines, improve the proliferation and activation of immune cells which plays a very important early protective role in patients after exposure. As PIKA rabies vaccine used under accelerated regimen could achieve a protective level of neutralizing antibodies as early as seven days post vaccination, it has the potential to minimize the risk for patients who fail to receive rabies immunoglobulin. Given the insufficient supply and usage of rabies immunoglobulin in the less developed countries, PIKA rabies vaccine has the potential to provide a higher protective level than that of the currently commercially available rabies vaccines.

On September 22, 2017, a WHO expert committee designated PIKA rabies vaccine as an innovative rabies vaccine in a background paper publication and highlighted two advantages of PIKA rabies vaccine as compared to other conventional rabies vaccine: (1) dose reduction (lower antigen use) and (2) accelerated vaccination regimen (shorter injection period from four weeks to one week).

In June 2022, YS Group obtained the approval of the Health Sciences Authority of Singapore ("HSA") for the Phase III clinical trials of PIKA Rabies vaccine to be conducted in Singapore. YS Group intends to start the trial in the first half of 2023. This Phase III study is a multi-center multi-country study to be conducted in Singapore, the Philippines, Pakistan and Vietnam. In China, YS Group has completed Phase I study of PIKA rabies vaccine, and preliminary results confirmed the dose regimen and safety observed from the Singapore trials. YS Group is planning to discuss with NMPA and launch more advanced trials in China in 2023. YS Group plans to submit the NDA/BLA for PIKA rabies vaccine to the regulatory authorities in China and major Southeast Asian countries, such as Singapore, upon completion of Phase III trials in the relevant countries.

***Strong research and development capabilities underpinned by innovative PIKA immunomodulating technology platform***

YS Group has built its business upon strong in-house research and development capabilities. YS Group's in-house developed PIKA immunomodulating technology platform has the potential to generate innovative vaccines. YS Group has a strong research and development team with global vision and rich industry experience. YS Group's fully integrated research and development team consists of approximately 180 members in China, the United States and Singapore with deep scientific talent from early discovery, late stage multi-country clinical development, to pilot and GMP mass production expertise of innovative vaccines and therapeutic biologics. YS Group has four research and development sites located in Maryland (the United States), Singapore, Beijing and Shenyang (China). YS Group also collaborates with research organizations and government agencies to supplement its in-house efforts and advance the development of its product candidates. YS Group is collaborating with Coalition for Epidemic Preparedness Innovations ("CEPI") for redundant Phase II clinical study of PIKA recombinant COVID-19 vaccine. In the United States, the National Institutes of Health ("NIH") has recognized the innovation and the potential of PIKA adjuvant in vaccine and other biologics fields and therefore has included PIKA adjuvant technology in the NIH vaccine adjuvant compendium, to promote scientific exchange and research collaboration around PIKA technology worldwide. YS Group also entered into a global health agreement with Adjuvant, a healthcare focused investment firm with joint objective to expand the commercialization of YSJA™ rabies vaccine in certain low income and lower-middle income countries.

YS Group has developed its PIKA immunomodulating technology platform to empower a robust pipeline of vaccines and therapeutic biologics. YS Group's proprietary PIKA immunomodulating technology stimulates both humoral and cell-mediated immunity by targeting toll-like receptor-3 (TLR3), retinoic acid inducible gene-I (RIG-I), and melanoma differentiation-associated protein 5 (MDA5). YS Group has thus far applied PIKA immunomodulating technology to multiple areas such as rabies vaccine, COVID-19, HBV and immuno-oncology therapeutic biologics, which have demonstrated substantially enhanced immune responses in relevant preclinical or clinical studies. YS Group has obtained patents relating to PIKA adjuvant in more than 30 countries and regions, which has laid a solid foundation for the commercialization of YS Group's product candidates across different jurisdictions. YS Group expects its PIKA immunomodulating technology platform to generate various innovative vaccines and therapeutic biologics.

YS Group's research and development capabilities are further strengthened by the expertise in other key aspects of vaccine and biologics development. For instance, YS Group has developed technology to design protein structures that are optimal for use in vaccines, which were adopted in the design of SARS-CoV-2 virus protein antigen for PIKA recombinant COVID-19 vaccine. YS Group also applied recombinant technology, with which YS Group introduce DNA of an antigen to a cellular expression system and purified such antigens for vaccine production. In addition, YS Group established multiple cell culture technology platforms and adopted bioreactors to increase the effectiveness and efficiency of its research and development efforts and optimize related costs. As formulation technology is critical to the safety, efficacy and stability of vaccines, YS Group has also developed related techniques in stabilizing protein or antigen molecules. For recombinant product candidates, YS Group's culture media formulations are free of animal components, and its product formulations are free of undesired phenol and preservatives, which helps ensure consistent product quality and reduce the risk of side effects.

YS Group's scientific advisory board, led by four prominent leaders in their respective fields, provides active guidance on biologics development and technology strategies. Dr. Yunde Hou was one of the two laureates for China's National Preeminent Science and Technology Award in 2017, the highest scientific award in China, and was also named as the Founder of Genetic Engineering and Father of Recombinant Interferon in China. Mr. Yongxin Yu is a renowned pioneer in the field of vaccinology and virology in China, having led the development of the SA14-14-2 strain for the Japanese encephalitis live attenuated vaccine, which was the first live attenuated vaccine against Japanese encephalitis in the world and suppressed the viral spread in China since its mass adoption. Dr. Mann Fung is the chief executive officer of Tavotek Biotherapeutics and former Vice President of the Johnson & Johnson. Dr. Guang Gao, as the senior technical officer at the Shanghai Representative Office of PATH and former biologist reviewer of Center for Biologics Evaluation and Research (CBER) of the FDA, has extensive experience in GMP manufacturing regulation, regulatory inspection, and review and approval of vaccines and biological products. Members of YS Group's scientific advisory board

play an active role in the review of its product development programs and routinely provide advice and insights on YS Group's research and development strategy and technical matters.

***Robust portfolio of innovative vaccines and therapeutic biologics to drive sustainable value creation***

YS Group has a robust portfolio of innovative product candidates based on its PIKA immunomodulating technology platform to address the unmet needs in preventing and/or treating infectious diseases and cancer. As of the date of this proxy statement/prospectus, YS Group has (1) four product candidates under various clinical development stages, including PIKA rabies vaccine, PIKA YS-ON-001, PIKA recombinant COVID-19 vaccine and PIKA YS-HBV-001, among which PIKA rabies vaccine and PIKA YS-ON-001 are categorized under Category I drugs by the NMPA, which are drugs that have a new and clearly defined structure, pharmacological property and apparent clinical value and have not been marketed anywhere in the world, and (2) four preclinical stage product candidates targeting HBV, influenza, rabies and cancer with enormous medical demand.

The following list sets forth YS Group's key product candidates, in addition to PIKA rabies vaccine, at various stages of development.

- *PIKA recombinant COVID-19.* PIKA recombinant COVID-19 vaccine is an innovative prophylactic and therapeutics vaccine candidate against multiple SARS-CoV-2 variants. PIKA recombinant COVID-19 vaccine is composed of YS Group's proprietary PIKA adjuvant and recombinant trimeric SARS-CoV-2 spike (S) protein subunit antigen (CHO cells). Results from YS Group's preclinical studies have demonstrated that PIKA recombinant COVID-19 vaccine achieved rapid, long-lasting and broad immune response against SARS-CoV-2. Compared with other COVID-19 vaccines with published data, PIKA COVID-19 vaccine can produce high-level antibodies 14 days after the initial immunization, while other vaccines generally need 3-6 weeks after the initial immunization to induce antibody production. By day 596 post prime vaccination, antibodies elicited by PIKA recombinant COVID-19 vaccine continued to effectively neutralize circulating variants SARS-CoV-2, including D614G, B.1.1.7 (Alpha), B.1.351 (Beta), P.1 (Gamma), B.1.617.2 (Delta) and B.1.1.529 (Omicron). YS Group completed Phase I trial of PIKA recombinant COVID-19 vaccine in the UAE in the first half of 2022, and the preliminary results showed that as basic immunization and sequential booster immunization, PIKA recombinant COVID-19 vaccines can induce the production of high-level neutralizing antibodies, which are effective for a variety of mutant strains, including Delta, Omicron sublineages BA.1, BA.2, BA.3, BA.4/5 and BA.2.12.1. In November 2022, YS Group obtained the clearance of IND for PIKA recombinant COVID-19 vaccine from FDA in the United States. YS Group has completed the enrollment of the multi-center multiple country Phase II/III studies in the Philippines and the UAE. The results of such phase III clinical trial are expected to be available in 2023.
- *PIKA YS-ON-001.* PIKA YS-ON-001 is an immuno-oncology therapeutic with broad indications for solid tumors. PIKA YS-ON-001 provides strong tumor inhibitory effect as a standalone therapy with tumor growth inhibition index of greater than 50% in 12 animal tumor models. PIKA YS-ON-001 has also demonstrated synergistic effect when combined with checkpoint inhibitors, kinase inhibitors and chemotherapies in multiple animal models of advanced solid tumors, including breast cancer, lung cancer, colorectal cancer and prostate cancer. PIKA YS-ON-001 is also mechanically complementary with other treatment modalities, such as chemotherapies, targeted therapies, local ablation, radiation therapy and oncolytic therapy. PIKA YS-ON-001 has the potential to become an integral immunotherapy component with chemotherapies, targeted therapies and checkpoint inhibitors or with other emerging immunotherapies that produce additive or synergistic treatment benefits. YS Group commenced the cancer patient enrollment for the Phase I clinical study in China in December 2021, focusing on the safety study on late-stage breast cancer, lung cancer, liver cancer and melanoma subjects.

Leveraging its PIKA immunomodulating technology platform, YS Group has developed a pipeline of other product candidates, including prophylactic vaccines such as PIKA YS-HBV-001, PIKA influenza vaccine, as well as therapeutic vaccines such as PIKA YS-HBV-002 for chronic HBV and PIKA YS-ON-002 for solid tumors. YS Group believes that its comprehensive, innovative portfolio of product candidates with commercialization potential will allow YS Group to diversify its revenue sources, sustain its growth and strengthen its competitive advantages.

***Established clinical development and manufacturing capability to prepare product launch***

From development to manufacture and commercialization, YS Group has optimized every key step towards the success of vaccines and therapeutic biologics. YS Group's clinical development team encompasses personnel with diverse development backgrounds of vaccine and drug products. YS Group's clinical development team has clinical trial experience in areas such as rabies, HBV, influenza, anthrax and oncology in several continents and also accumulated regulatory experience with regulatory authorities in the United States and Asia. The development of adjuvanted vaccines is a specialized and sophisticated field in the biotechnology industry, and YS Group's clinical team has built up first-hand experience in adjuvant selection, dose optimization, study design and pharmaco-vigilance, all of which are crucial to the successful development and application of adjuvants.

The manufacture of vaccines is a complex and lengthy process which directly determines the quality and safety and thus the commercial success of vaccine products. The capability to manufacture vaccines on a commercial scale requires in-depth expertise and process know-how, presenting a significant entry barrier against potential competition. YS Group manufactures YSJA™ rabies vaccine and clinical trial materials in its current GMP-compliant facilities with highly efficient and automated process to ensure high product quality and production efficiency. YS Group's manufacturing center in Shenyang (China) occupies over 12,000 sq.m. with facilities designed and maintained in compliance with GMP standards to yield a current annual production capacity of 15 million doses. YS Group has achieved operational excellence at its manufacturing facilities by adopting production technologies that support large-scale manufacturing, including advanced automation system, high density suspension culture technology and high-throughput chromatography purification technology. YS Group also implements rigorous manufacturing standard and advanced manufacturing system to ensure product quality and safety, such as various bioreactor systems for the mass production of proteins and antigens. YS Group has developed and obtained patents for its manufacturing techniques and devices, including removal of residual DNA and protein impurities, sterilization technology in heating, ventilation, and air-conditioning and cooling system during its manufacturing process to ensure product quality and purity for human use. YS Group is also planning to construct manufacturing facilities with the functions of formulation, filling, freeze-drying and packaging in Singapore in 2023.

***Established commercialization capabilities and established expansive sales network***

With YS Group's track record in commercializing YSJA™ rabies vaccine, YS Group has demonstrated its commercialization capabilities and established its expansive sales network. As of September 30, 2022, YS Group had built its experienced in-house commercialization team with approximately 40 team members and collaborated with about 120 external service providers to achieve expansive coverage across the country. As of September 30, 2022, YS Group had obtained qualifications from 30 province-level CDCs. In the two fiscal years ended March 31, 2022 and the six months ended September 30, 2022, YS Group had sold more than 16 million doses of YSJA™ rabies vaccine to approximately 1,625 county-level CDCs in China, representing 50% of all the county-level CDCs in China.

YS Group has established a well-designed and highly effective commercialization infrastructure to execute its sales and marketing plans. YS Group's in-house commercialization team diligently manages its sales and marketing activities across approximately 336 cities in China as of September 30, 2022, with an average industry experience of over 12 years such as the sales and marketing of biologics at multinational corporations. With rich industry knowledge and resources, YS Group's in-house commercialization team monitors its sales performance and seeks growth opportunities by ensuring its sales relationships with CDCs in their covered regions. They oversee and coordinate the activities of its external service providers, conduct market research and analysis, and monitor information about its product. YS Group believes that its in-house commercialization team is highly effective to allow YS Group to achieve greater economies of scale, maintain price stability, monitor its customer base, and foster customer loyalty. Through YS Group's in-house commercialization team, YS Group has engaged external service providers to support its sales and marketing efforts among practitioners and execute its sales plan. The extensive network of service providers assists in collecting and providing clinical information of products, including the product quality, safety and adverse event data from the clinical sites, monitoring the shipment and inventory at customer warehouse, managing account payable and payment collection, conducting product training and education programs for practitioner, which greatly strengthens YS Group's product presence and loyalty in the market place. Moreover,



under the supervision of YS Group's in-house commercialization team, the service providers execute its sales plans effectively with their own sales forces and network resources. YS Group believes that its product candidates will benefit from the operating leverage enabled by YS Group's established and highly scalable commercialization infrastructure, expertise and strategy to rapidly achieve market success.

***Seasoned management team with local expertise and global vision and backed by blue-chip investors.***

YS Group has a management team with leadership combination of rich local expertise in China and global vision from multinational corporations in the vaccine and pharmaceutical industry, strategizing YS Group's research and development, operations and commercial success. YS Group's management team has comprehensive and complementary capabilities in the vaccine industry, spanning from early research and development, manufacture to commercialization.

Mr. Yi Zhang, YS Group's founder and chairman, has over 35 years of experience in China's biopharmaceutical industry and has led various successful national research projects, such as National 863 Scientific Project "SARS Immunoglobulin" and YS Group's National Key New Medical Innovation projects on PIKA rabies vaccine. Mr. Zhang had the first-hand experience in epidemiology, infectious disease control and vaccination campaigns in local CDC offices in China. Mr. Zhang is the lead author of multiple research publications and co-inventor of multiple patents and technologies.

Dr. Hui Shao, YS Group's president and chief executive officer, has over 25 years of distinguished scientific and industrial background in biotechnology and pharmaceutical fields, ranging from drug discovery, business strategy and product commercialization to private and public capital market in the United States, Europe and Asia. Dr. Shao has proven track record of leadership such as in drug innovation at Roche, biotech investment in the United States and strategic alliance transactions in several jurisdictions.

Dr. Zenaida Reynoso Mojares, YS Group's chief medical officer of the Group has over 17 years of experience in the medical and clinical field. Dr. Mojares is a highly accomplished medical professional with diverse experience in medical, clinical research, pharmacovigilance and public health in both private and national government sectors. Prior to joining YS Group, Dr. Mojares had served as the chief medical officer and the head of Clinical Development & Regulatory department respectively at International Vaccine Institute in Seoul, South Korea.

In addition, YS Group's scientific advisory board, established in 2011, plays an active role in the review of YS Group's biologics development programs. YS Group's scientific advisory board currently consists of four reputable leaders in their respective fields of expertise. YS Group believes that the collective knowledge and well-rounded expertise of YS Group's senior management, together with YS Group's scientific advisory board, synergize with each other and provide YS Group with vital guidance and insights in the fast-growing and competitive biopharmaceutical industry.

YS Group's shareholders consist of reputable healthcare investors, endowing YS Group with industry expertise and crucial connections to the pharmaceutical industry in China and worldwide.

**Growth Strategies**

YS Group's vision is to become a global leader in transformative vaccines and therapeutic biologics. To achieve this goal, YS Group intends to pursue the following strategies.

***Maximize and expand commercial potential for YSJA<sup>TM</sup> rabies vaccine in existing markets and other countries untapped***

YS Group intends to drive the full-scale commercialization of YSJA<sup>TM</sup> rabies vaccine to capture the robust demand for rabies vaccine existing and prospective markets. The market size of rabies vaccines in China, in terms of market production value, is expected to increase from RMB9.4 billion in 2021 to RMB22.1 billion in 2025, at a CAGR of 23.8%, and further to RMB33.3 billion in 2030, at a CAGR of 8.5% from 2025 to 2030, according to the F&S Report. To capture the medical needs in these markets, YS Group expects to expand its manufacturing facilities and bolster its sales efforts. In addition to YS Group's existing manufacturing facilities in Shenyang, China, which have an annual production capacity of approximately 15 million doses of YSJA<sup>TM</sup> rabies vaccines, YS Group plans to build an integrated manufacturing center in Singapore with the functions

of formulation, filling, freeze-drying and packaging to boost its overall vaccine and therapeutic biologics production capacities for supply to multiple markets.

YS Group plans to step up the commercialization of YSJA™ rabies vaccine in China by both increasing YS Group's market share in those regions where YS Group has established its presence and entering into greenfield markets. By the end of 2022, YS Group plans to leverage its in-house commercialization team and external service providers in China to reach a coverage of approximately 1,900 county-level CDC accounts in China. YS Group also intends to boost the recognition and demand of YSJA™ rabies vaccine by pursuing academic communications with CDCs, KOLs and other healthcare professionals specialized in vaccines and disease prevention.

YS Group also plans to unleash the commercial potential of YSJA™ rabies vaccine in the underserved markets in Southeast Asian countries, leveraging the significant competitive advantages over the currently available products in those markets. YS Group expects to apply for license in certain Southeast Asian countries and assemble a local sales force with abundant local resources and know-hows. YS Group expects its local sales force to cover major clinical centers and hospitals where the administration of immunological biologics tends to be concentrated, which will allow YS Group to tap into the local markets directly and efficiently. YS Group will also continue to collaborate with the WHO, global institutions and KOLs to promote its marketed products worldwide.

***Accelerate the development and commercialization of core product candidates***

YS Group has developed PIKA rabies vaccine as next-generation product candidate of rabies vaccine with accelerated regimen and superior profile to capture the demand from China, Southeast Asia and other emerging markets. In June 2022, YS Group obtained the approval of HSA for the Phase III clinical trials of PIKA Rabies vaccine to be conducted in Singapore. YS Group intends to start the trial in the first half of 2023. This Phase III study is a multi-center multi-country study to be conducted in Singapore, Philippines and Vietnam. In China, YS Group has completed Phase I study of PIKA rabies vaccine, and preliminary results confirms the dose, regimen and safety observed from the Singapore trials. YS Group is planning to discuss with NMPA and launch more advanced trials in China in 2023. YS Group plans to submit the NDA/BLA for PIKA rabies vaccine to the regulatory authorities in China and major Southeast Asian countries, such as Singapore, upon completion of Phase III trials in the relevant countries. YS Group believes that its accumulated experience and resources in vaccine sales, manufacture and commercialization will be a strong driving force for the market launch of PIKA rabies vaccine and lay a solid foundation for its future expansion. YS Group plans to expand its manufacturing facilities in Shenyang (China) and establish its manufacturing facilities in Singapore to prepare for the launch of PIKA rabies vaccine and other product candidates.

YS Group also plans to strategically accelerate the development and commercialization of its existing pipeline candidates based on its PIKA immunomodulating technology to realize its full potential in other important prophylactic and therapeutic areas. To address the urgent and strong demand for COVID-19 vaccines with sustainable and broad protections against emerging virus mutants, YS Group submitted the IND application for the prophylactic and therapeutic PIKA recombinant COVID-19 vaccine to regulatory authorities of multiple jurisdictions in 2021. YS Group completed Phase I trial of PIKA recombinant COVID-19 vaccine in the UAE in the first half of 2022 with preliminary results. In November 2022, YS Group obtained the clearance of IND for PIKA recombinant COVID-19 vaccine from FDA in the United States. YS Group has completed the enrollment of the Phase II/III multi-center multi-country clinical studies in the Philippines and UAE. YS Group is currently enrolling cancer patients for the Phase I clinical study of PIKA YS-ON-001 in China. YS Group completed the Phase I clinical trial of PIKA YS-HBV-001 in Singapore in 2017. YS Group expects to enter into Phase II trials in Singapore in 2023. In addition, YS Group expects its immuno-oncology therapeutic candidates to become an integral immunotherapy component in oncology treatment paradigm. To that end, YS Group is pursuing an accelerated development strategy under selected oncology indications in China, the United States and Southeast Asia. In the meantime, YS Group will expedite preclinical development of other pipeline candidates targeting influenza, HPV and multiple oncology indications.

***Advance PIKA immunomodulating technology platform and broaden its commercialization potential***

YS Group believes that its proprietary PIKA immunomodulating technology platform is core to the discovery and development of innovative biologics and will continue to be instrumental to YS Group's success. YS

Group's in-depth understanding in human immunology and the integration of the immunology discovery into product development are pivotal to the accomplishments of its PIKA immunomodulating technology platform. YS Group will continue to invest in its PIKA immunomodulating technology to further enhance its immunological efficacy. In addition, YS Group will continue to boost the intellectual property protection of its PIKA immunomodulating technology and related products.

YS Group plans to continue to leverage its PIKA immunomodulating technology to broaden its commercialization potential by focusing on therapeutic and prophylactic opportunities in immune-related diseases, and develop new product candidates based on its potential benefits such as those in immune modulating pathways and efficacy. YS Group has commenced a series of development programs of immunological biologics in treating and preventing cancer. YS Group will also expedite the preclinical development of other pipeline candidates targeting influenza, HPV and multiple oncology indications. In addition, YS Group plans to collaborate or partner with internationally recognized organizations to advance new immunological biologics product candidates and to enter under-penetrated market territories.

***Enhance YS Group's research and development to strengthen competitive advantages in product and technology innovation***

YS Group strives to achieve product and technology innovation in immunology and have demonstrated achievements at several stages of research and development. YS Group believes that its research and development capabilities that continuously support its innovation are fundamental to its success. YS Group plans to continue to invest in its research and development initiatives to further its competitive advantages in product and technology innovation. For instance, YS Group plans to build its new research and development center in Singapore to leverage on its deep talent pool and favorable research and development environment as well as access to the Southeast Asian markets. YS Group's Singapore research and development center will encompass a wide spectrum of innovative projects at the clinical stage, ranging from immunology technology and product development, and from vaccines to therapeutic biologics categories.

YS Group also plans to continue to attract, retain and train highly qualified talents to maintain its competitive advantages and support the commercialization of its product candidates. YS Group expects to continue the expansion of its research and development team, especially in China, Southeast Asia and the United States, by recruiting professionals specialized in technology and product candidates relating to vaccines and immune-oncology biologics. As it continues to increase the scale and scope of its product portfolio, YS Group expects to strengthen the protection of its intellectual property rights and pipeline assets by recruiting intellectual property specialists and engaging external experts. In addition, YS Group plans to continue the expansion of its regulatory affairs team as YS Group seeks to embark on product development and commercialization in multiple jurisdictions.

***Pursue integrated global growth strategy through international collaborations and partnerships***

YS Group believes that its marketed product and product candidates with desirable attributes have the potential to benefit patients and gain market acceptance worldwide, especially the emerging markets. YS Group has strategically allocated its research and development, manufacture and commercialization efforts in China, Singapore and the United States to benefit from the clinical, commercial and regulatory advantages across different geographical markets. To transform into a global biopharmaceutical company, YS Group is actively expanding its new drug development, product registration and manufacturing functions, such as its ongoing active talent recruitments in Singapore, as YS Group is positioning its Singapore site as a center of excellence as part of its globalization strategy. In the United States and Europe, YS Group is also expanding its global reach by collaborating with world renowned partners.

YS Group plans to accelerate its business growth by obtaining additional valuable resources through strategic global collaborations and acquisitions. YS Group intends to expand its pipeline through selective collaborations with reputable organizations or institutions, in particular pursuing synergistic co-development opportunities. Furthermore, YS Group intends to seek potential partnership and licensing with leading pharmaceutical companies to commercialize YSJA™ rabies vaccine in Europe, Africa and South America and enhance the commercial returns and presence of its products in multiple jurisdictions. YS Group believes that such effort serves as part of its integrated strategy to drive its sustained growth.

### YS Group’s Marketed Product and Product Candidates

YS Group has generally adopted a self-developed approach with respect to its PIKA-adjuvanted product pipeline. YS Group’s PIKA adjuvant is based on a novel mechanism of action for adjuvants supported by its PIKA immunomodulating technology platform, through which YS Group is developing prophylactic and therapeutic biologics. YS Group has made significant in-house advancement of PIKA immunomodulating technology, such as in researching its mechanism of action, developing multiple clinical applications, establishing PIKA-related manufacturing capabilities and enhancing its IP protection. YS Group further combined PIKA adjuvant with well-established vaccine mechanism of action, such as those for rabies and HBV, to develop a pipeline of innovative vaccines targeting specific viral infections. In addition to leveraging its PIKA immunomodulating technology platform, YS Group’s marketed product, YSJA™ rabies vaccine, is a validated, conventional rabies vaccine product based on a well-established mechanism of action of rabies vaccine.

#### Overview

YS Group’s portfolio consists of eight biologics, including one marketed product, four clinical-stage candidates and four preclinical candidates. In addition, YS Group is working on a series of therapeutic targets and products at the discovery stage. The following table summarizes the development status of its portfolio of marketed product and product candidates.

Programs	Classification/ Regulatory Designation**	Status							Upcoming milestones	
		Preclinical	IND	Phase 1	Phase 2	Phase 3	NDA/BLA	Marketed		
Conventional Vaccine	YSJA™ (Conventional rabies vaccine)		China							
	PIKA Rabies Vaccine (rabies vaccine)	Category I New Drug (China) Orphan Drug Designation (U.S. FDA) National Key Medical Innovation Project (China)	Singapore							<ul style="list-style-type: none"> <li>Expect to enter into Phase III clinical trial in certain Southeast Asian countries including Singapore &amp; Philippines in the first half of 2023</li> <li>Expect to enter into more advanced clinical studies in China in 2023</li> </ul>
			Philippines							
			China							
	PIKA Recombinant COVID-19 Vaccine (prophylactic/injectable)		The UAE							<ul style="list-style-type: none"> <li>Expect to obtain results of Phase III clinical trial in 2023</li> </ul>
			Philippines							
			The U.S.							
	PIKA Recombinant COVID-19 Vaccine (prophylactic/nebulized)								<ul style="list-style-type: none"> <li>Expect to enter into Phase I trial in 2023</li> </ul>	
	PIKA Recombinant COVID-19 Vaccine (therapeutic)								<ul style="list-style-type: none"> <li>Expect to enter into Phase I trial in 2023</li> </ul>	
	PIKA YS-ON-001 (Cancer)	Category I New Drug (China) Orphan Drug Designation (U.S. FDA for pancreatic cancer and hepatocellular cancer)	Singapore							<ul style="list-style-type: none"> <li>Expect to complete Phase I trial in China in 2023</li> </ul>
			China							
	PIKA YS-HBV-001 (HBV vaccine)			Singapore						<ul style="list-style-type: none"> <li>Expect to enter into Phase II trials studies in 2023</li> </ul>
	PIKA YS-HBV-002 (Chronic HBV therapy)									<ul style="list-style-type: none"> <li>Expected IND submission in 2023</li> </ul>
PIKA YS-ON-002 (Cancer)									<ul style="list-style-type: none"> <li>Expected IND submission in 2023</li> </ul>	
PIKA Influenza Vaccine									<ul style="list-style-type: none"> <li>Expected IND submission in 2023</li> </ul>	
PIKA Rabies Vaccine (Human diploid cell)									<ul style="list-style-type: none"> <li>Expected IND submission in 2024</li> </ul>	

 Preclinical stage
  Clinical stage
  Marketed

YS Group’s candidates are subject to approval by the relevant authorities, such as the NMPA of China, the HSA of Singapore and/or other equivalent authorities before commercialization in such jurisdictions.

***Vaccine mechanism of action***

Vaccine is a biological product to safely induce an immune response that confers protection against infection and/or disease on subsequent exposure to a pathogen. To achieve such goal, vaccines are mostly designed to address natural defense mechanisms and activate the immune system in a manner similar to natural infections.

The human immune system comprises two major components: the innate and the adaptive immune system. Innate and adaptive immunity work sequentially to identify invading pathogens and initiate the most effective defense response. The interaction of innate and adaptive immunity is crucial to generate and maintain a protective immune response. Specialized antigen-presenting cells (APCs) are especially important to bridge the two components of the immune system.

The innate immune system represents the first line of host defense against pathogens which includes the body's physical barriers (e.g., skin, mucosal membranes, and enzymes), molecules (e.g., complement) and cells (e.g., macrophages, dendritic cells, neutrophils, monocytes, and natural killer cells). The innate immune system senses the invasion of pathogen via pattern recognition receptors (PRRs) expressed on innate immune cells. Toll-like receptors (TLRs), a class of PRRs, recognize pathogen-associated molecular patterns (PAMPs) that are shared by several pathogens. For instance, TLR3 recognizes viral double-stranded RNA. The binding of TLRs triggers secretion of chemical messengers, such as cytokines and chemokines, from infected cells and/or innate immune cells to attract other resident and circulating innate cells to the site of infection, and leads to the development of adaptive immune responses.

The adaptive immune system represents the second line of immunological defense. Unlike the innate immune defense which is fast reacting but lacks specificity, adaptive immune responses are antigen specific. Moreover, memory cells are generated in the course of adaptive immune response, which will provide a faster and stronger immune response when the body encounters the same pathogen in the future. The adaptive immune responses are mediated by APCs that capture and digest the antigen that are complexed with major histocompatibility complexes (MHCs) and presented to lymphocytes. There are two subsets of lymphocytes, namely B cells and T cells. Activated B cells can produce and secrete antigen specific antibodies that can facilitate phagocytosis or complement-mediated killing of pathogens or neutralize toxins by binding to their appropriate antigens. There are two major subsets of T cells, CD4+ T cells with regulatory functions and CD8+ T cells with effector functions. In most cases CD4+ cells will help other immune cells perform their task and are referred to as helper T cells (Th). T helper 2 (Th2) cells secrete mainly interferon-gamma (IFN $\gamma$ ), a cytokine known to limit pathogen survival and promote the differentiation of CD8+ cells. Th2 cells produce various cytokines (e.g., interleukins (IL) including IL-4, IL-5 and IL-13) that preferentially activate innate immune cells (e.g., eosinophils and mast cells) and facilitate especially the immune response to extracellular pathogens. Another subset, termed follicular T helper cell (T<sub>fh</sub>) is characterized by the secretion of IL-21, a cytokine thought to favor the secretion of antibodies by antigen-specific B cells. Finally, regulatory CD4+ T cells (Treg cells) inhibit immune or inflammatory responses by blocking the activity of effector T cells, helper T cells, and APCs.

CD8+ T cells can destroy cells infected by intracellular pathogens such as viruses by secretion of cytotoxic factors. In addition, CD8+ T cells can inhibit viral replication without destroying the infected cells by producing cytokines (interferon) to interfere with pathogen replication. CD8+ cytotoxic cells also can eliminate cells exhibiting abnormal host peptides, such as those presented by tumor cells, and therefore play an important role in the immune control of aberrant cell growth.

***YSJA™ Rabies Vaccine — YS Group's marketed product***

YSJA™ rabies vaccine is an aluminum-free, inactivated Vero cell based vaccine, which is the first aluminum-free lyophilized rabies vaccine developed in China. Since its launch in 2003, approximately 97 million doses have been administered to patients for post-exposure protection against rabies. YSJA™ rabies vaccine improves the suitability of human rabies vaccine to rabies in China and causes less pain, injection site discomfort and fever to patients compared with certain rabies vaccines in China. YS Group's current manufacturing facilities in Shenyang, China received the GMP certificate in July 2019, pursuant to which YS Group started the production of YSJA™ rabies vaccine in February 2020 and its sales in October 2020. As of September 30, 2022, YS Group had manufactured approximately 26 million doses of YSJA™ rabies vaccine

from its GMP-compliant facilities, in which approximately 16 million doses have been sold to approximately 1,625 county-level CDCs in China.

#### *Mechanism of action*

Rabies neutralizing antibodies are widely accepted to correlate with the protection against rabies. A minimum level of 0.5 IU/mL is used by the WHO as a correlate of protection. This level of rabies virus neutralizing antibodies should be achieved by day 14 of post-exposure immunization.

#### *Market opportunity and competition*

Human rabies is a viral disease that causes acute encephalitis with almost 100% mortality rate if post-exposure prophylaxis (PEP) is not administered timely prior to the onset of symptoms. In most developing countries, immediate PEP is the most effective option to control the incidences and deaths from rabies.

Human rabies occurs in more than 150 countries and territories worldwide and is a significant public health concern in developing countries, especially in many Asian and African countries, with approximately 35,000 rabies-caused deaths occurring each year in Asia, according to the WHO. According to the F&S Report, approximately 49 million of people were bitten by dogs and other rabies-carrying animals in China in 2021, and this number is expected to increase to 52 million in 2025 and further to 55 million in 2030. The penetration rate of rabies vaccine was 40.6% in 2021, and is expected to increase to 65.7% in 2025 and further to 75.5% in 2030. Thanks to human rabies vaccine, the number of new incidences of rabies infection in China decreased from 801 in 2015 to 290 in 2019, out of which the number of deaths was 744 and 276 in 2015 and 2019, respectively, and human rabies vaccine is expected to continue to play a critical role in suppressing rabies in China in the future.

Due to various factors such as the change in the number of market players, adjustment in production volume and the impact of a scandal involving the then second largest rabies vaccine manufacturer in July 2018, the market production value of China's rabies vaccine fluctuated during 2015 and 2019, with an overall decline at a negative CAGR of 4.7%. China's human rabies vaccine market production value is expected to increase from RMB9.4 billion in 2021 to RMB22.1 billion in 2025, at a CAGR of 23.8%, and is expected to further increase to RMB33.3 billion, at a CAGR of 8.5% from 2025 to 2030.

According to the NMPA and the F&S Report, there were nine marketed human rabies vaccine products based on purified Vero cell technology in China as of December 31, 2021.

#### *Advantages*

YSJA™ rabies vaccine uses fixed CTN-1 strain to produce vaccine in Vero cells, which demonstrates advantages such as:

- Improved suitability for rabies in China. The sequence analysis has shown that the homology between CTN-1 strain and most wild Chinese rabies isolates was between 81.5% to 93.4%, higher than PM-1 strain used in other licensed vaccines, which has made CTN-1 strain more suitable for rabies in China. Approximately 97 million doses of YSJA™ rabies vaccine have been administered in China.
- Higher immunogenicity. A head-to-head study conducted by an independent clinical research group in 2007 has demonstrated that CTN-1 strain-derived rabies vaccine produced higher immunogenicity than rabies vaccine using other virus strains.
- Better safety profile. According to a head-to-head study, the administration of YSJA™ rabies vaccine causes less pain and injection site discomfort to patients. YSJA™ rabies vaccine is also associated lower rate of fever compared with certain other rabies vaccines in China.

Four head-to-head clinical studies were conducted by certain CDC centers in China to evaluate the safety and adverse reactions between the YSJA rabies vaccine and other rabies vaccines marketed by other producers. Such trials included both children under 10 years old and adult patients. The head-to-head study among adult patients also evaluated the immune responses of various human use rabies vaccines marketed in China.

The material details of such four head-to-head clinical studies are set out below:

(1) A head-to-head clinical study conducted by Guangxi CDC center in China to evaluate adverse reactions of YSJA rabies vaccine and another leading product in China among children under 10 years old.

The trial enrolled 1025 children under 10 years old including 477 subjects and 548 subjects receiving YSJA rabies vaccine and the comparison vaccine, respectively. The results showed that the rate of fever among patients receiving the comparison vaccine was 48.4% (265/548), higher than the rate of fever to patients of YSJA rabies vaccine 18.4% (88/477) ( $P<0.05$ ). In the comparison group, fever was most common in children under 3 years old. The older the age, the lower the probability of fever. The study concluded that it is recommended to use YSJA rabies vaccine for children under 10 years old, especially under 3 years old in order to reduce the incidents of adverse reactions.

(2) A head-to-head clinical study conducted by Guizhou CDC center in China to evaluate adverse reactions and immune response of YSJA rabies vaccine and another leading product among adult patients.

The 100 subjects enrolled in the study were randomized into two groups (50 in study group receiving YSJA rabies vaccine and 50 in control group receiving the other leading products). The result showed that there were three cases of adverse reactions reported in the YSJA rabies vaccine group, lower than the total number of adverse reactions in the control group of 10 cases (20.00%). Comparing the antibody seroconversion rate between two groups, the total number of seroconversion cases in the study group was 49 (98.00%), and the total number of seroconversion cases in the control group was 40 (80.00%) ( $P<0.05$ ). The study concluded that the adverse reaction rate of YSJA rabies vaccine was lower and the seroconversion rate was higher comparing to those of the other leading product.

(3) A head-to-head study conducted by Qiannan CDC center in Guizhou, China to evaluate adverse reactions of YSJA rabies vaccine and another leading product in China.

The trial enrolled 206 post-exposure patients including 102 subjects and 104 subjects receiving YSJA rabies vaccine and the comparison vaccine, respectively to observe the incidence of adverse reaction after 72 hours of the injection. The results showed that the adverse reactions rate receiving the comparison vaccine was 24.03%, higher than the adverse reactions rate receiving YSJA rabies vaccine 8.82%. The difference was statistically significant ( $P<0.01$ ). The study concluded that it is recommend to use YSJA rabies vaccine as the first choice due to its lower rate of adverse reactions.

(4) A head-to-head clinical study conducted by Yiwu CDC center in Zhejiang, China to evaluate adverse reactions of YSJA rabies vaccine with an imported lyophilized rabies vaccine and another domestic liquid rabies vaccine.

The trial enrolled 300 post-exposure patients who were randomized into three groups (100 subjects receiving YSJA rabies vaccine, 100 subjects receiving an imported lyophilized rabies vaccine and 100 subjects receiving a domestic liquid rabies vaccine) to observe the adverse reaction incidences and the immune responses after 14 and 42 days of the first injection, respectively. The results showed that the local adverse reactions rates receiving the YSJA rabies vaccine, imported lyophilized rabies vaccine and domestic liquid rabies vaccine were 3.6%, 3.2% and 28.6% respectively and the systemic adverse reactions rates for the 3 groups were 1.2%, 0.8% and 4.4% respectively. Comparing the seroconversion rate measured by neutralizing antibody titers among 3 groups, the seroconversion rates receiving the YSJA rabies vaccine, imported lyophilized rabies vaccine and domestic liquid rabies vaccine were 96%, 98% and 82% after 14 days of the first injection; 98.98%, 98.99% and 93.68% after 42 days of the first injection. The study concluded that, compared to the liquid rabies vaccine, the lyophilized rabies vaccine showed statistical significance with lower adverse reaction rate, higher seroconversion rate and longer terms of validity. There was no statistical significance between YSJA rabies vaccine and the imported lyophilized rabies vaccine in terms of the adverse reaction rate and seroconversion rate but YSJA rabies vaccine was more affordable with a lower price for most post-exposure patients to meet their needs domestically.

Moreover, the adoption of purified Vero cell technology in YSJA<sup>TM</sup> rabies vaccine offers several advantages in terms of mass production, such as:

- *High production scalability.* Purified Vero cell technology provides high scalability suitable for mass production, which also achieves high product quality and low risk of exogenous contamination, based on the Technical Guidelines for Human Rabies Prevention and Control (2016) issued by the national CDC in China.

- *Established product profile.* Approximately 97 million doses of YSJA™ rabies vaccine have been administered in China, consistent with less side effects of rabies vaccines under Vero cell technology claimed by Technical Guidelines for Human Rabies Prevention and Control (2016).
- *Enhanced convenience and stability.* YSJA™ rabies vaccine is in freeze-dried (as opposed to a liquid) form, and is easier to store and transport as well as less susceptible to changes in temperature, reducing potential product spoilage.
- *Reliable purity.* YS Group has successfully developed a series of proprietary and patented purification technologies to effectively remove residual DNA and protein impurities during the manufacturing process, which helps ensure the quality and purity of YS Group's vaccine products for human use.

#### *Commercialization and marketing plan*

YS Group received the GMP certificate for its manufacturing facilities in Shenyang, China in July 2019, pursuant to which YS Group started the production of YSJA™ rabies vaccine in February 2020 and the sales in October 2020. In the two fiscal years ended March 31, 2022 and the six months ended September 30, 2022, YS Group had manufactured approximately 26 million doses of YSJA™ rabies vaccine, out of which YS Group had sold more than 16 million doses to approximately 1,625 county-level CDC customers in China. YS Group has developed advanced bioreactor engineering process to further improve its production throughput, efficiency and quality control. By the end of 2022, YS Group plans to increase the number of its in-house commercialization team and increase the number of external service providers to reach a coverage of county-level CDC customer accounts of approximately 1,900 in China.

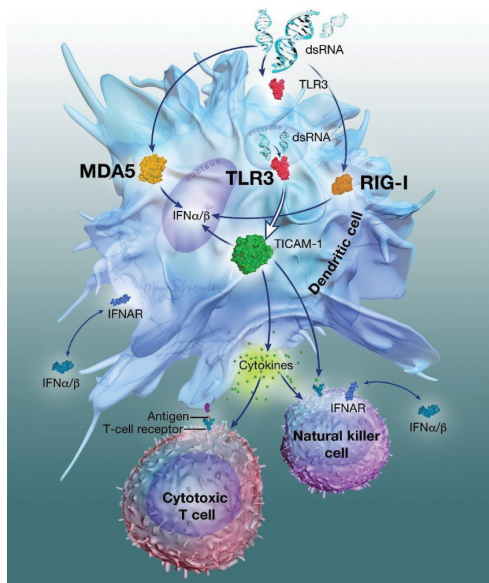
YS Group is seeking potential partnership and licensing with leading pharmaceutical companies to commercialize YSJA™ rabies vaccine in major Southeast Asian market. YS Group also intends to expand it into Europe, Africa and South America and enhance the commercial returns and presence of its products in multiple jurisdictions.

#### *YS Group's clinical stage product candidates*

Leveraging its proprietary PIKA immunomodulating technology platform, YS Group has developed a pipeline of product candidates targeting viral infections and cancer. YS Group's PIKA molecule is a class of double strand RNA (dsRNA) molecules of well-defined, specific ribonucleic acid units and molecular weight distribution synthesized with YS Group's proprietary technology. Endosomal dsRNA can be recognized by TLR3 while cytosolic dsRNA can be sensed by the retinoic acid-inducible gene (RIG) I-like receptor (RLR) family which include RIG-I and melanoma differentiation-associated protein 5 (MDA5). The immuno-potentiating effects of PIKA include: (1) promoting the activation and maturation of dendritic cells, (2) up-regulating the co-stimulatory molecules, such as CD80, CD86 and HLA-DR on dendritic cell, (3) activating and promoting the maturation of dendritic cells, (4) enabling the dendritic cells to act as potent antigen presenting cells for effective activation of naive B and T lymphocytes which in turn lead to a more robust specific immune response, (5) inducing the activation and proliferation of both B cells and NK cells, (6) triggering the TLR3 pathway which induces IL-2 and type I IFNs production, (7) improving MHC category II expression and cross-presentation of antigen, and (8) promoting Th1 (cellular) based immunity through its induction of IL-2 and type I IFNs. For more details, see the section entitled “— Research and Development — PIKA Immunomodulating Technology.” The following figure sets forth the signaling pathway and function of PIKA.



Figure 1. Signaling Pathway and Function of PIKA



### *PIKA Rabies Vaccine*

PIKA rabies vaccine is a lyophilized human-use rabies vaccine composed of cell culture-derived rabies antigen mixed with PIKA adjuvant which acts as a TLR3 agonist. This vaccine candidate is based upon YS Group's deep foundation in YSJA™ rabies vaccine, coupled with YS Group's proprietary PIKA adjuvant and advanced manufacturing techniques. Leveraging YS Group's proprietary PIKA immunomodulatory technology platform, PIKA rabies vaccine is designed to induce accelerated and strong cellular immunity and stimulate the body to rapidly produce higher humoral immune response. Its accelerated onset of immune response allows a three-visit one-week regimen superior to the currently available vaccine with a five-visit one-month or three-visit three-week regimen, which shortens the treatment period by two to three weeks. YS Group is independently developing PIKA rabies vaccine which was designated by a WHO expert committee background paper publication as an innovative rabies vaccine in 2017.

In June 2022, YS Group obtained the approval of HSA for the Phase III clinical trials of PIKA Rabies vaccine to be conducted in Singapore. YS Group intends to start the trial in the first half of 2023. This Phase III study is a multi-center multi-country study to be conducted in Singapore, Philippines, Pakistan and Vietnam. In China, YS Group has completed Phase I study of PIKA rabies vaccine and preliminary results confirm the dose, regimen and safety observed from the Singapore trials. YS Group is planning to discuss with NMPA and launch more advanced trials in China in 2023. YS Group plans to submit the NDA/BLA for PIKA rabies vaccine to the regulatory authorities in China and major Southeast Asian countries, such as Singapore, upon completion of Phase III trials in the relevant countries.

### *Mechanism of action*

PIKA rabies vaccine is composed of cell culture-derived rabies antigen mixed with PIKA adjuvant that is acting as a TLR3 agonist. As a result, PIKA rabies vaccine has a distinct role in promoting cellular and humoral immunity and thus has the dual prophylactic and post-exposure therapeutic characteristics. In particular, the high level of innate immune response and balanced Th1/Th2 immune response induced by PIKA rabies vaccine play a crucial role in the protection of rabies virus. PIKA rabies vaccine can quickly induce the production of a variety of chemokines and cytokines, and improve the proliferation and activation of immune cells, which plays a very important early protective role in patients after exposure. For a description of mechanism of action for rabies vaccines, see the section entitled “— YSJA™ Rabies Vaccine — YS Group's Marketed Product — Mechanism of Action” above.

### Market opportunity and competition

According to the CDE and the F&S Report, there were 23 human rabies vaccine candidates in China as of December 31, 2021. For the market opportunity for rabies vaccine, including incidence and prevalence of rabies, treatment options and costs, see the section entitled “— YSJA™ Rabies Vaccine — YS Group’s marketed product — market opportunity and competition.” The WHO and the national CDC in China recommend PEP in the combination of vaccine and rabies immunoglobulin injections. However, the current supply of human rabies immunoglobulin can only meet the less than 10% of the overall demand, according to the F&S Report, and most patients only receive rabies vaccine after the exposure, representing a significant addressable market in patients who fail to or otherwise cannot adopt immunoglobulin.

PIKA rabies vaccine is under clinical trial indicated for both pre- and post-exposure rabies prophylaxis and was designated by a WHO expert committee document as innovative rabies vaccine in 2017. This product candidate was also granted Orphan Drug Designation (ODD) by the U.S. FDA for prevention of rabies infection including post-exposure prophylaxis for against rabies. PIKA rabies vaccine is designed as a premium product that targets the high-end rabies vaccine market and differentiates from existing conventional rabies vaccines. YS Group expects it to become the next generation of rabies vaccine and capture significant opportunity in China and other emerging markets, or even replace conventional rabies vaccines, given its accelerated one-week regimen, and enhanced protection level, especially in light of the insufficient supply and usage of rabies immunoglobulin in less developed countries. YS Group plans to complete the clinical trials and apply for market approval in China, Southeast Asia, Africa and Latin America.

### Advantages

According to the WHO guidance, the most commonly used biologics to treat rabies are PEP regimen that consists of rabies vaccine with the combination of rabies immunoglobulin. However, they have the following limitations:

- *PEP rabies vaccine regimens.* The two most common PEP rabies vaccination regimens are the Essen (five injections administered on days 0, 3, 7, 14, and 28) and the Zagreb schedule (two injections administered on day 0 and one injection on days 7 and 21 each). However, the administration of PEP must be as early as possible to give the optimal chance of protection against developing clinical disease. Deviation from the recommended PEP protocol could also result in clinical rabies. In addition, fatalities are common even after the administration of appropriate PEP, particularly when rabies immunoglobulin has not been either administered or appropriately administered. Severe bites to highly innervated areas, such as face, neck or hand, significantly shorten the incubation period, which causes insufficient time for the development of a protective immune response. Suboptimal response of current vaccine has been reported in populations with compromised immunity, such as HIV/AIDS-infected patients, and with immature immunity, such as children. The WHO has recognized the limitations of current rabies PEP practice and is tasked to reduce the duration of course and number of dose administered under the current PEP regimen. Animal challenge experiments have also *indicated* that rabies vaccine alone does not offer guaranteed protection because the injection of the vaccine usually takes 10-12 days to produce sufficient antibodies, which lags behind the time that the virus proliferates and invades the nerve tissue in the local muscle cells.
- *Rabies immunoglobulin.* The treatment currently recommended by the WHO requires the administration of rabies immunoglobulin, which is a type of rabies neutralizing antibodies derived from human blood, together with rabies vaccines. The injected antibodies act to neutralize the rabies virus before the human immune system produces its own antibodies. However, immunoglobulin is often expensive and limited in supply in developing countries. In China, the adoption rate of rabies immunoglobulin is relatively low. According to the Technical Guidelines for Human Rabies Prevention and Control (2016), it is estimated that over 90% of post-exposure patients at clinics in some provinces with higher incidence of rabies in China can be classified as category II and III which require the PEP regimen of rabies vaccine with the combination of rabies immunoglobulin, of which approximately 40% falls under category III, the most severe type in terms of wounds. However, the local injection of rabies immunoglobulin is still a painful and costly procedure, and it is estimated that only 15% of category III patients received rabies immunoglobulin injection, according to the same source.

The excellent immunogenicity and lack of serious adverse events under the accelerated PIKA rabies vaccine program has been recognized by the WHO. The WHO highlighted PIKA rabies vaccine in their 2017

background paper on rabies. A successful PIKA rabies vaccine will further the WHO's agenda to reduce the course of rabies vaccine. PIKA rabies vaccine has the following advantages over the existing rabies vaccine.

- *Dual prophylactic and therapeutic characters.* PIKA rabies vaccine has a distinct role in promoting cellular and humoral immunity in the type of immune response and thus has the dual character of both prophylactic and therapeutic vaccines. In particular, balanced CD4 and CD8 cellular immune responses play a key role in post-exposure immune protection.
- *Earlier and higher neutralizing antibody production.* The improved 2-2-1 immunization regimen provides accelerated and strong specific immune response for early protection and improves the patient compliance of immunization. The clinical studies to date have shown that PIKA rabies vaccine can be used under an accelerated regimen, achieving protective level of neutralizing antibodies as early as seven days post vaccination, eliciting more robust immunogenic response compared to that of the control arm vaccine, which is a widely used commercially available vaccine. PIKA rabies vaccine has also showed good reactogenicity and tolerability, comparable to that of the commercially available vaccine.
- *Induction of strong cellular immunity.* PIKA rabies vaccine can activate cellular immunity, including specific and nonspecific cellular immunity. Clinical study has shown that PIKA rabies vaccine is capable of inducing more potent T cell response than currently available rabies vaccines, which is beneficial for protection after exposure.
- *Potential to enhance protection without immunoglobulin.* PIKA rabies vaccine used under accelerated regimen may achieve protective level of neutralizing antibody as early as seven days post vaccination, which minimize the risk for patients who fail to adopt rabies immunoglobulin. Given the insufficient supply and low adoption rate of immunoglobulin in China and other developing countries, PIKA rabies vaccine has the potential to enhance the protection level than that of commercially available rabies vaccine.

#### Summary of preclinical and clinical studies

To capture the underserved market demand for new generations of rabies vaccines in the emerging markets, YS Group has developed a global clinical development plan comprising, generally in chronological order, the following clinical trials:

- (1) a Phase I trial among 37 healthy volunteer subjects in Singapore, which was completed in February 2016;
- (2) a Phase II trial among 126 healthy volunteer subjects in Singapore, which was completed in July 2016;
- (3) a Phase I trial among 96 healthy volunteer subjects in China to confirm the dose regimen and safety observed in Singapore clinical trials, which was completed in 2021;
- (4) a multi-country, multi-center Phase III registration trial among approximately 4,500 healthy subjects using a post exposure prophylaxis schedule in multiple Southeast Asian countries, which is expected to be conducted in the first half of 2023; and
- (5) a Phase III registration trial among approximately 400 post exposure subjects in China, which is expected to be conducted in 2023.

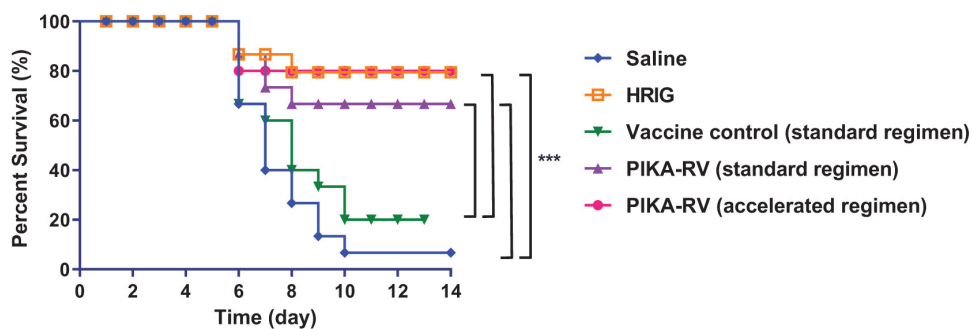
In Singapore, YS Group completed Phase I and Phase II clinical trial of PIKA rabies vaccine. In June 2022, YS Group obtained the approval of HSA for the Phase III clinical trials of PIKA Rabies vaccine to be conducted in Singapore. YS Group intends to start the trial in the first half of 2023. This Phase III study is a multi-center multi-country study to be conducted in Singapore, Philippines, Pakistan and Vietnam. In China, PIKA rabies vaccine completed Phase I study of PIKA rabies vaccine with preliminary results which confirmed the dose, regimen and safety observed from the Singapore trials.

YS Group expects to conduct the pivotal Phase III clinical trials in Southeast Asia in healthy volunteers without exposure to animal bite, which are estimated to be approximately 4,500 subjects in total, in the first half of 2023. YS Group is planning to discuss with NMPA and launch more advanced trials in China in 2023. YS Group plans to submit the NDA/BLA for PIKA rabies vaccine to the regulatory authorities in China and major Southeast Asian countries, such as Singapore, upon completion of Phase III trials in the relevant countries.

### Preclinical Study

PIKA rabies vaccine has been extensively investigated in several animal models for immunogenicity and protective efficacy. In post-exposure efficacy test, groups of hamsters were infected with lethal dose of wild type BD06 strain rabies virus followed by immunization with normal saline, human rabies immunoglobulin (HRIG), vaccine control of standard regimen (days 0, 3, 7, 14 and 28), PIKA rabies vaccine of standard regimen, and PIKA rabies vaccine of accelerated regimen (double dose on days 0, 2 and single dose on day 7) respectively. The results have showed that PIKA rabies vaccine administered using a standard regimen conferred 66.7% survival rate and 80% with an accelerated regimen, compared to 20% survival rate provided by standard regimen of commercially available rabies vaccine (Figure 2). Animal studies have shown that administration of PIKA rabies vaccine using accelerated regimen results in improved survival in infected mice and high levels of neutralizing antibody production as early as four days after immunization.

Figure 2. Survival rate after PEP by PIKA rabies vaccine in golden hamster

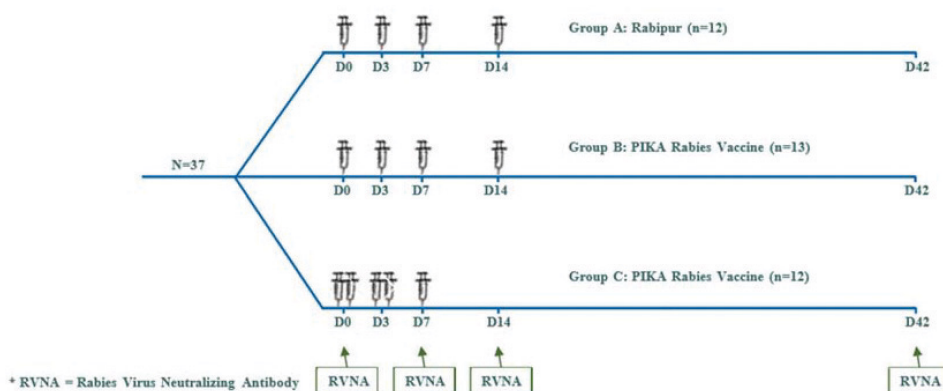


Significant difference between survival curves was determined by the Chi-square test ( $***p < 0.005$ ). There is no significant difference between the groups not marked.

In order to further evaluate the efficacy of PIKA rabies vaccine, the representative strains of seven major rabies virus populations in the world were used as challenge viruses to challenge mice. In each challenge study with variants of street rabies virus, groups of mice were challenged with lethal dose of different strain rabies virus followed by immunization with PBS, Commercial Rabies Vaccine of standard regimen (days 0, 3, 7, 14 and 28), and PIKA rabies vaccine of accelerated regimen (double dose on days 0, 2 and single dose on day 7) respectively. The results showed that compared with the commercial rabies vaccine, the PIKA rabies vaccine could provide a more comprehensive protective effect, with a protective effect of more than 80% on all seven viruses (Table 2). In addition, PIKA rabies vaccine demonstrated quick onset of neutralization antibody titers and higher seroconversion rate at day 5 post the first dose injection of vaccines.

### Phase I Clinical Trial in Singapore

The Phase I clinical trial of PIKA rabies vaccine was conducted in Singapore. The study was a single-center, open label, randomized study in healthy naive adult subjects to determine the safety and immunogenicity of PIKA rabies vaccine. A total of 37 subjects were enrolled and randomly assigned to receive Rabipur, standard PIKA rabies vaccine and accelerated PIKA rabies vaccine. The vaccine dosage of Phase I clinical trial in Singapore was 1.0 mL. Rabipur marketed by Novartis is a commercialized rabies vaccine which was produced using Flury LEP rabies virus strain grown in a culture of primary chick embryo fibroblast cells. The dosing regimen for Rabipur recommended by the United States Centers for Disease Control and Prevention is four doses which are to be administered on days 0, 3, 7 and 14. No deviation from such approved regimen, including accelerated regimen, was allowed in humans with respect to Rabipur.

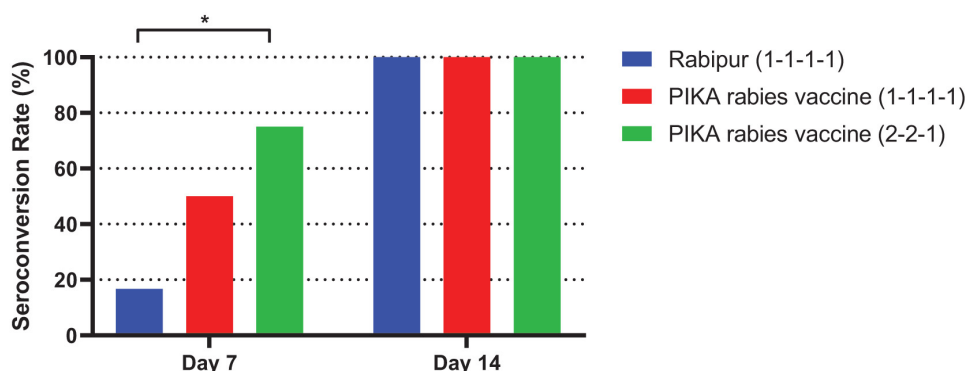


The groups of Rabipur and standard PIKA rabies vaccine followed the same vaccine regimen (1-1-1-1), where one injection on days 0, 3, 7 and 14 each was administered. The group of accelerated PIKA rabies vaccine received the accelerated regimen (2-2-1), where two injections on both days 0 and 3 were administered in different arms, and only one injection was administered on day 7. Seroconversion is defined as post-vaccination serum rabies virus neutralizing antibody (RVNA) titer equal to or higher than 0.5 IU/mL, while the RVNA is absent in pre-vaccination serum. Such seroconversion as defined in YS Group's clinical trials is in line with those of other clinical trials for rabies vaccines. The Phase I clinical trial has demonstrated that, on day 7 under same 1-1-1-1 dosing regimen, only 16.7% of subjects receiving Rabipur seroconverted compared to that of 50% of subjects receiving PIKA rabies vaccine. Under the accelerated regimen, the PIKA rabies vaccine had a higher seroconversion rate with 75% by day 7, significantly higher than the control arm vaccine under the classic regimen. In addition to achieving higher immunogenicity, PIKA rabies vaccine elicited CD4 mediated T cell response detectable as early at day 7 which was maintained at day 42. No death or serious adverse events were reported in this trial. All adverse events in both the PIKA vaccine arms and the Rabipur arm are mild in severity. The incidence of adverse events is comparable between the PIKA vaccine arms and the Rabipur arm. The result has showed that PIKA rabies vaccine is safe and well tolerated. The following table sets forth the Phase I clinical results in Singapore concerning adverse events.

System Organ Class (SOC)	Preferred term (PT)	Rabipur N=12 (in n (%))	PIKA Rabies Vaccine (1-1-1-1) N=13 (in n (%))	PIKA Rabies vaccine (2-2-1) N=12 (in n (%))
Gastrointestinal disorders	Diarrhoea	1 (8.33%)	0 (0.00%)	1 (8.33%)
	Nausea	0 (0.00%)	1 (7.69%)	0 (0.00%)
General disorders and administration site conditions	Induration	1 (8.33%)	0 (0.00%)	0 (0.00%)
	Fatigue	1 (8.33%)	0 (0.00%)	0 (0.00%)
	Injection site pain	0 (0.00%)	6 (46.15%)	3 (25.00%)
	Injection site swelling	0 (0.00%)	1 (7.69%)	0 (0.00%)
	Pyrexia	0 (0.00%)	1 (7.69%)	0 (0.00%)
Infections and infestations	Lymph gland infection	1 (8.33%)	0 (0.00%)	0 (0.00%)
	Pyuria	0 (0.00%)	2 (15.38%)	1 (8.33%)
Investigations	Glucose urine present	0 (0.00%)	2 (15.38%)	0 (0.00%)
Musculoskeletal and connective tissue disorders	Myalgia	0 (0.00%)	0 (0.00%)	1 (8.33%)
Nervous system disorders	Dizziness	0 (0.00%)	1 (7.69%)	0 (0.00%)
	Headache	0 (0.00%)	1 (7.69%)	1 (8.33%)
	Lethargy	1 (8.33%)	0 (0.00%)	1 (8.33%)
Renal and urinary disorders	Proteinuria	0 (0.00%)	2 (15.38%)	0 (0.00%)

System Organ Class (SOC)	Preferred term (PT)	Rabipur N=12 (in n (%))	PIKA Rabies Vaccine (1-1-1-1) N=13 (in n (%))	PIKA Rabies vaccine (2-2-1) N=12 (in n (%))
Respiratory, thoracic and mediastinal disorders	Cough	0 (0.00%)	1 (7.69%)	0 (0.00%)
Skin and subcutaneous tissue disorders	Hyperhidrosis	0 (0.00%)	1 (7.69%)	0 (0.00%)
	Pruritus	0 (0.00%)	1 (7.69%)	0 (0.00%)
	Urticaria	0 (0.00%)	0 (0.00%)	1 (8.33%)
Total number of subject with at least one adverse event		5 (41.67%)	9 (69.23%)	6 (50.00%)

Figure 3. Percentage of subjects with protective serum neutralizing antibodies ( $\geq 0.5$  IU/mL)



Significant difference between seroconversion rate was determined by the Fisher's exact test ( $*p < 0.05$ ). There is no significant difference between the groups not marked.

At the last visit day (day 42), the levels of neutralizing antibody titer in PIKA rabies groups, being administered under either the 1-1-1-1 or the 2-2-1 regimen, were comparable to that of the control group. The follow table sets forth the levels of neutralizing antibody titer on day 42 in Phase I clinical trial in Singapore.

	Rabipur mean $\pm$ standard deviation 95% confidence interval	PIKA Rabies Vaccine (1-1-1-1) mean $\pm$ standard deviation 95% confidence interval	PIKA Rabies Vaccine (2-2-1) mean $\pm$ standard deviation 95% confidence interval
<b>Neutralizing antibody titer</b>	9.72 $\pm$ 11.66 (-2.67, 22.11)	12.07 $\pm$ 10.07 (-0.31, 24.46)	20.06 $\pm$ 33.12 (8.26, 33.04)

#### Phase II Clinical Trial in Singapore

Phase II clinical trial was conducted in two hospitals in Singapore. It was a multi-center, open label, randomized, non-inferiority study in healthy naive adult subjects to evaluate the efficacy and safety of the PIKA rabies vaccine under an accelerated regimen. 126 participants were enrolled and randomized into two groups, receiving Rabipur and PIKA rabies vaccine. PIKA rabies vaccine recipient achieved higher seroconversion rate (57.6%) at day 7 as compared to Rabipur (43.8%). All subjects in both PIKA rabies vaccine and Rabipur groups achieved seroconversion. The primary endpoint of non-inferiority was met. Phase II clinical trial further supported the efficacy of the PIKA rabies vaccine under accelerated regimen, with earlier and higher production of neutralizing antibody as early as seven days after vaccination. Consistent with the adverse events findings in Phase I, no death or serious adverse events were reported in this trial. The majority of adverse events in the clinical trials conducted on PIKA rabies vaccine are mild to moderate in severity. The

incidence of adverse events is comparable between the PIKA rabies vaccine arm and the Rabipur arm. The safety and tolerability profile of the PIKA rabies vaccine in such large sample size trial was comparable to that of Rabipur.

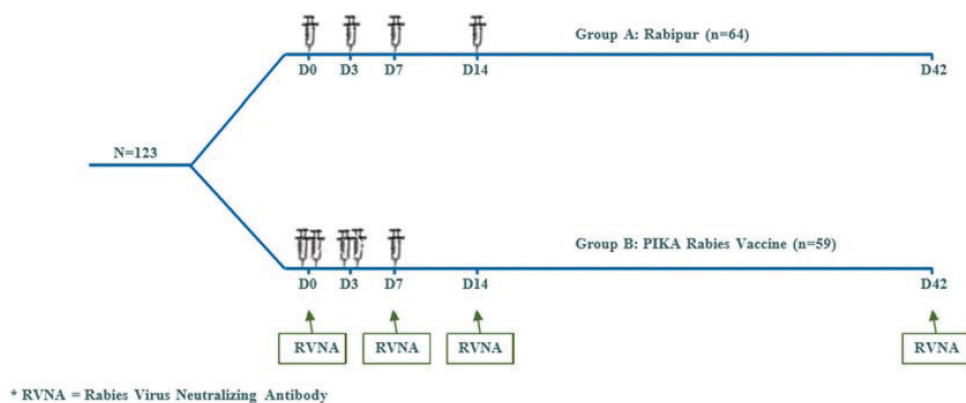
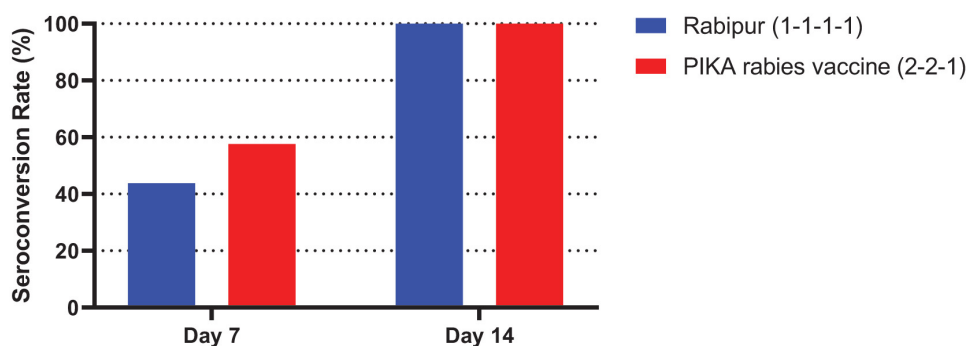


Figure 4. Percentage of subjects with protective serum neutralizing antibodies ( $\geq 0.5$  IU/mL)



Significant difference between seroconversion rate was determined by the Fisher's exact test. There is no significant difference between the groups.

At the last visit day (day 42), the level of neutralizing antibody titer in PIKA rabies group was comparable to that of the control group. The follow table sets forth the levels of neutralizing antibody titer on day 42 in Phase II clinical trial in Singapore.

	Rabipur	PIKA Rabies Vaccine (2-2-1)
	mean $\pm$ standard deviation 95% confidence interval	mean $\pm$ standard deviation 95% confidence interval
<b>Neutralizing antibody titer</b>	19.16 $\pm$ 13.53 (15.69, 22.62)	21.59 $\pm$ 46.90 (9.15, 34.04)

The standard deviation of the neutralizing antibody titers in PIKA rabies vaccine arm appears to be wider due to one outlier which is beyond the upper test limit. The protection level of rabies vaccine is generally considered to be reached once neutralizing antibody titer reaches 0.5 IU/mL.

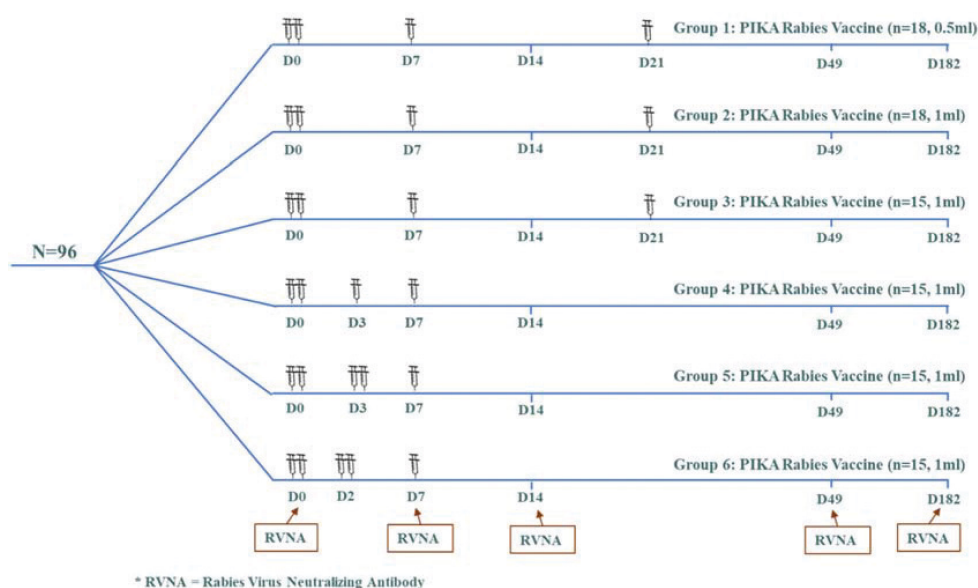
The accelerated regimen of PIKA rabies vaccine is advantageous to the standard Zagreb or Essen regimens because the standard regimens fail to induce higher and earlier seroconversion at day 7 post vaccination. Given that the incubation period of rabies is approximately two or three months, YS Group's future clinical studies will evaluate the neutralizing antibody titers beyond 42 days, up to six months and 12 months,

respectively, and YS Group will compare the antibody titers at different time points after vaccination between PIKA rabies vaccine and the commercialized rabies vaccines in comparison.

### Phase I Clinical Trials in China

To re-confirm the dosage and regimen selected in Singapore trial to apply to the population in China, a Phase I study was designed and is being conducted in China to evaluate the safety and immunogenicity of PIKA rabies vaccine administered at different dosage and various dosing regimen.

A total of 96 subjects were enrolled in Phase I clinical trial. Two dose levels, 0.5mL and 1.0mL of PIKA rabies vaccine were evaluated using 2-1-1 regimen given on day 0, 7 and 21 (approved regimen for the currently marketed rabies vaccine). Four different dosing regimens were evaluated, including 2-1-1 regimen given on day 0, 7 and 21, 2-1-1 regimen given on day 0, 3 and 7, 2-2-1 regimen given on day 0, 3 and 7, 2-2-1 regimen given on day 0, 2 and 7. The design of Phase I clinical trial includes (1) the primary safety and immunogenicity endpoints, and (2) the secondary endpoint of antibody level, seroconversion and cellular immunity. The primary safety endpoints include: (1) solicited adverse events collected seven days after each vaccination, (2) unsolicited adverse events collected 49 days after the first immunization, and (3) serious adverse events on throughout the study. The primary immunogenicity endpoint includes seroconversion rate at predefined time points post vaccination. The secondary endpoint is measured by the antibody titers at different time points post immunization.



No safety concerns were revealed. No deaths and serious adverse events were reported. No vaccine-related grade 3 adverse events were reported. The Phase I findings are consistent with those from Singapore trials and further demonstrates the capability of PIKA rabies vaccine of rapid and robust antibody response.

Preliminary results of Phase I study of PIKA rabies vaccine in China confirmed the dose, regimen and safety observed from the Singapore trials. The early seroconversion is clinically meaningful, given that in the event of grade 3 exposure without administration of immunoglobulin, early seroconversion is a principal indication of the early presence of protective neutralizing antibody in the blood.

### Phase III Clinical Trial Plan in Southeast Asian Countries

A phase III, randomized, comparator-controlled, double-blind, multicenter study was designed to evaluate the immunogenicity, safety and lot to lot consistency of three lots of a PIKA Adjuvanted inactivated rabies vaccine in healthy adults using a post-exposure prophylaxis schedule. The clinical study will be a multi-center, multi-country trial in Singapore, Philippines, Pakistan and Vietnam, which is planned to start in the second half of 2022.



Primary immunogenicity objectives of the study consist of demonstration of immunologic non-inferiority of PIKA rabies vaccine to the comparator Rabipur as measured by GMTs of RVNA and seroconversion rate differences at Day 14 and Day 28 and demonstration of lot-to-lot consistency of 3 production lots of PIKA rabies vaccine as measured by RVNA GMTs at Day 14. Co-primary safety objectives will include evaluation of all safety data collected from the study including changes in safety laboratory parameters from baseline. Secondary objectives include demonstration of immunological superiority of PIKA rabies vaccine to Rabipur as measured by seroconversion rate differences at Day 7 and evaluation of immune persistence of PIKA rabies vaccine as compared to Rabipur.

In this study, a total of 4,500 subjects will be enrolled in the study randomized with 3000 subjects allocated to PIKA rabies vaccine and 1,500 allocated to receive the comparator rabies vaccine Rabipur. The following table sets forth each class of subjects and the respective allocated study days of vaccination.

#### Treatment Allocation

Group	Vaccine	Regimen	Study Days of Vaccination					N
			0	3	7	14	28	
1	PIKA Rabies Vaccine lot#1	2-2-1	XX	XX	X	O	O	1000
2	PIKA Rabies Vaccine lot#2	2-2-1	XX	XX	X	O	O	1000
3	PIKA Rabies Vaccine lot#3	2-2-1	XX	XX	X	O	O	1000
4	Comparator	1-1-1-1-1	XO	XO	X	X	X	1500
<b>Total</b>								<b>4500</b>

#### *PIKA Recombinant COVID-19 Vaccine (injectable)*

YS Group began to develop in-house PIKA YS-SC2-010, also known as PIKA recombinant COVID-19 vaccine, in January 2020. PIKA recombinant COVID-19 vaccine is being developed for the indication to have both prophylactic and therapeutic effects against COVID-19 disease caused by SARS-CoV-2, which is composed of YS Group's proprietary PIKA adjuvant and recombinant trimeric SARS-CoV-2 spike (S) protein subunit antigen (CHO cells). Preclinical studies results have demonstrated that PIKA recombinant COVID-19 vaccine achieved rapid, long-lasting and broad immune response against SARS-CoV-2. Compared with other COVID-19 vaccines with published data, PIKA COVID-19 vaccine can produce high-level antibodies 14 days after the initial immunization, while other vaccines generally need 3-6 weeks after the initial immunization to induce antibody production. By day 596 post prime vaccination, antibodies elicited by PIKA recombinant COVID-19 vaccine continued to effectively neutralize circulating variants SARS-CoV-2, including D614G, B.1.1.7 (Alpha), B.1.351 (Beta), P.1 (Gamma), B.1.617.2 (Delta) and B.1.1.529 (Omicron). Cynomolgus monkey study results also showed both prophylactic and therapeutic effects against SARS-CoV-2. PIKA YS-SC2-010 has exhibited significant inhibition against virus replication with important treatment effect. YS Group submitted the IND application for the prophylactic and therapeutic PIKA recombinant COVID-19 vaccine as a prophylactic vaccine to regulatory authorities of multiple jurisdictions, including Singapore, in 2021. YS Group completed Phase I trial of PIKA recombinant COVID-19 vaccine in the UAE in the first half of 2022 and the preliminary results showed that as basic immunization and sequential booster immunization, PIKA recombinant COVID-19 vaccines can induce the production of high-level neutralizing antibodies, which are effective for a variety of mutant strains, including Delta, Omicron sublineages BA.1, BA.2, BA.3, BA.4/5 and BA.2.12.1. In November 2022, YS Group obtained the clearance of IND for PIKA recombinant COVID-19 vaccine from FDA in the United States. YS Group has completed of the enrollment of the multi-center multi-country Phase II/III clinical trials in the Philippines and UAE. The results of such phase III clinical trial are expected to be available in 2023.

#### Mechanism of action

Historically, vaccine-induced protective immunity has been largely attributed to the function of antibodies, especially neutralizing antibodies that block the entry of the virus into target host cells and thus prevent infection. Due to their capabilities of providing immediate protection upon exposure, the elicitation of

neutralizing antibodies has long been the primary goal of vaccination against many pathogens, including SARS-CoV-2. The immune responses to SARS-CoV-2 involve innate immune activation and antigen-specific responses of B and T cells.

PIKA recombinant COVID-19 vaccine is a recombinant full-length, wild-type SARS-CoV-2 spike glycoprotein optimized in the established CHO expression system. The major target of neutralizing antibodies to SARS-CoV-2 is the S protein consisting of S1 and S2 domains. S1 is membrane distal and contains the receptor binding domain (RBD) that binds to the cellular receptor ACE2. S2 is membrane proximal and plays a role in membrane fusion. Antibodies binding to the S1 RBD can block interaction with ACE2 and antibodies binding to the S2 can inhibit conformation changes of the S protein and block membrane fusion. Therefore, the majority of COVID-19 vaccine candidates under preclinical and clinical development use the full-length S protein. To stabilize the full-length spike protein of SARS-CoV-2, YS Group made two modifications to the S protein sequence, including the modification of S1/S2 furin cleavage site 682-RRAR-685 to 682-GSAS-685 and the introduction of two proline substitutions at positions K986P and V987P.

PIKA recombinant COVID-19 vaccine is a recombinant S protein vaccine with PIKA adjuvant to enhance and prolong both antibody and cellular immunity and ultimately provide durable protective effect. According to a recent challenge study in non-human primates, potent and durable neutralizing antibodies play an important protective role, and CD8+ T cell responses also contribute to protection especially when the antibody responses are suboptimal. In several late-stage clinical trials, S protein-based vaccines in mRNA and viral vector-based platforms have shown excellent preliminary vaccine efficacy against multiple SARS-CoV-2 variants.

### Market opportunities and competition

According to the WHO and the F&S Report, there are 14 vaccines approved for use by WHO, NMPA, FDA or emergency approval, and 70 COVID-19 vaccines in clinical Phase III and above as of July 31, 2022. According to a study from John Hopkins University and the F&S Report, herd immunity of COVID-19 could be achieved when 70% to 90% of the population acquire immunity. Assuming that an individual needs an average of two doses of COVID-19 vaccine to achieve immunity, a corresponding total of 10.5 to 13.5 billion doses and 2.0 to 2.5 billion doses of COVID-19 vaccines are required to achieve herd immunity globally and in China, respectively.

WHO label	Pango lineage	GISAID clade/lineage	Nextstrain clade	Earliest documented samples	Date of designation
<b>VOCs<sup>(1)</sup></b>					
Alpha	B.1.1.7	GR/501Y.V1	20I (V1)	The United Kingdom, September 2020	December 18, 2020
Beta	B.1.351	GH/501Y.V2	20H (V2)	South Africa, May 2020	December 18, 2020
Gamma	P.1	GR/501Y.V3	20J (V3)	Brazil, November 2020	January 11, 2021
Delta	B.1.617.2	G/478K.V1	21A	India, October 2020	VOI: April 4, 2021 VOC: May 11, 2021
<b>VOIs<sup>(2)</sup></b>					
Epsilon	B.1.427/B.1.429	GH/452R.V1	21C	The U.S., March 2020	March 5, 2021
Zeta	P.2	GR/484K.V2	20B	Brazil, April 2020	March 17, 2021
Eta	B.1.525	G/484K.V3	21D	Multiple countries, December 2020	March 17, 2021
Theta	P.3	GR/1092K.V1	21E	Philippines, January 2021	March 24, 2021
Iota	B.1.526	GH/253G.V1	21F	The U.S., November 2020	March 24, 2021
Kappa	B.1.617.1	G/452R.V3	21B	India, October 2020	April 4, 2021
Lambda	C.37	GR/452Q.V1	20D	Peru, August 2020	June 14, 2021

(1) A SARS-CoV-2 variant is a VOC if it meets the definition of a VOI and, through a comparative assessment, has been demonstrated to be associated with one or more of the following changes at a degree of global public health significance: (i) increase in transmissibility or detrimental change in COVID-19 epidemiology; or increase in virulence or change in clinical disease presentation; and/or (ii) decrease in effectiveness of public health and social measures or available diagnostics, vaccines and therapeutics.

(2) A SARS-CoV-2 isolate is a VOI if, compared to a reference isolate, its genome has mutations with established or suspected

phenotypic implications, and either: (i) has been identified to cause community transmission/multiple COVID-19 cases/clusters, or has been detected in multiple countries; or (ii) is otherwise assessed to be a VOI by the WHO in consultation with the WHO SARS-CoV-2 Virus Evolution Working Group.

Source: the WHO, the F&S Report

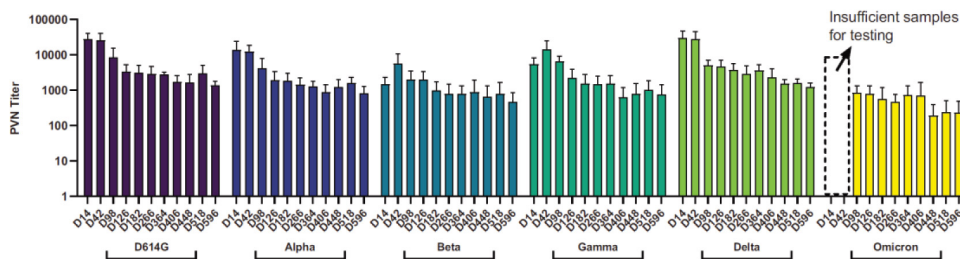
### Advantages

PIKA recombinant COVID-19 vaccine is an innovative prophylactic and therapeutic vaccine candidate against multiple SARS-CoV-2 variants. PIKA recombinant COVID-19 vaccine is composed of YS Group's proprietary PIKA adjuvant and recombinant trimeric SARS-CoV-2 spike (S) protein subunit antigen (CHO cells). It is made by using genetically engineered recombinant CHO cells, which are cultured, harvested, concentrated and purified to obtain S-trimer protein designed according to the structure of S-protein of SARS-CoV-2 virus, and added with appropriate stabilizer and PIKA adjuvant. The production process of PIKA recombinant COVID-19 vaccine relies on mature genetic engineering technology of recombinant protein, which is highly scalable and poses low biosafety risk.

Preclinical studies results have demonstrated that PIKA recombinant COVID-19 vaccine has achieved rapid and efficient production of neutralizing antibody and cellular immunity to provide quick and sustained protection, with the titer of neutralizing antibodies against pseudovirus and wild-type SARS-CoV-2 virus induced by vaccine being up to 104, which shows a good immune effect. Moreover, the neutralizing antibodies induced by PIKA recombinant COVID-19 vaccine can persist for at least 596 days post-immunization, indicating a good durability of the immune response. The results of prophylaxis animal challenge tests have shown that the PIKA recombinant COVID-19 vaccine could significantly inhibit virus replication, and could relieve the inflammation in lung. In addition, PIKA recombinant COVID-19 vaccine can significantly enhance the antigen-specific cellular immune response and convert the Th2-bias immune response to the Th1-bias immune response, decreasing the risk of antibody dependent enhancement.

PIKA recombinant COVID-19 vaccine is effective against the currently prevalent mutant strains, in particular multiple virus variants of SARS-CoV-2, including D614G, B.1.1.7 (Alpha), B.1.351 (Beta), P.1 (Gamma), B.1.617.2 (Delta) and B.1.1.529 (Omicron). As indicated in Figure 13, neutralizing antibodies measured at day 14, 42, 98, 126, 182, 266, 364, 406, 448, 518 and 596 post prime vaccination in New Zealand rabbit study demonstrated rapid, efficient, sustainable and high protection against multiple virus variants of SARS-CoV-2.

Figure 5. Neutralizing antibodies against multiple virus variants of SARS-CoV-2 in New Zealand rabbit study



In terms of therapeutic effect, previous studies have shown that type I IFN response and T cell response may be crucial for the control and recovery of SARS-CoV-2 infection. Therefore, the rapid induction of SARS-CoV-2 specific T cell immune response in the early stage of infection may effectively alleviate the symptoms of COVID-19 patients and accelerate the recovery process. The results of cellular immune response have demonstrated that PIKA recombinant COVID-19 vaccine can promote the early antigen-specific T cell immune response, which may play a role in alleviating the symptoms of COVID-19 patients and accelerating the recovery process. In a non-human primates study, vaccinated groups had significantly lower viral load than the control group, which indicates that vaccination using PIKA recombinant COVID-19 vaccine can significantly inhibit virus replication and demonstrates significant treatment effect. The results of therapeutic animal challenge tests have also demonstrated that recombinant COVID-19 vaccine could significantly reduce the viral load of the lung.

Based on the results of YS Group's controlled animal studies (not head-to-head), YS Group observed that PIKA recombinant COVID-19 vaccine, once marketed, may have the following characteristics and advantages:

- *High level of neutralizing antibodies.* PIKA recombinant COVID-19 vaccine generated a high level of neutralizing antibodies. It has demonstrated a high level of neutralizing antibody activities against the SARS-CoV-2 virus as discussed above.
- *Sustainable antibody response.* PIKA recombinant COVID-19 vaccine generated sustainable neutralizing antibodies against the original virus strain and most of the currently prevalent mutant strains of the SARS-Cov-2 virus at post prime vaccination on day 14, 42, 98, 126, 182, 266, 364, 406, 448, 518 and 596.
- *Broad range of protection against mutant virus strains.* PIKA recombinant COVID-19 vaccine demonstrated strong response to a broad range of mutant SARS-CoV-2 virus strains currently prevalent in the world, including but not limited to D614G, B.1.1.7 (Alpha), B.1.351 (Beta), P.1 (Gamma), B.1.617.2 (Delta) and B.1.1.529 (Omicron).
- *Rapid production of antibodies and protection against multiple SARS-COV-2 variants.* PIKA recombinant COVID-19 vaccine has the potential to be administered in two doses with a relatively short interval and enables the rapid and high production of antibodies, which is particular important during a highly transmissible infection.
- *Broad and balanced Th1, Th2 immune response.* PIKA recombinant COVID-19 vaccine has the potential to generate strong CD4+ and CD8+ T-cell responses, which may provide protection especially in the case of weak antibody responses. Moreover, balanced Th1 and Th2 immune responses could be elicited by PIKA recombinant COVID-19 vaccine, which may decrease the risk of antibody dependent enhancement.
- *Unique therapeutic benefit.* PIKA recombinant COVID-19 vaccine exhibits promising treatment benefit in animal studies, which has the potential to become a therapeutic vaccine against the virus.
- *Versatile recombinant vaccine for mass production.* With an universal profile to induce stronger and broader range of sustainable and high neutralizing antibody response rate against existing and emerging variants, PIKA recombinant COVID-19 vaccine has the potential to achieve economy of scale which is considerably more suitable for mass production.
- *Favorable storage condition.* PIKA recombinant COVID-19 vaccine has the potential to be stored at a temperature between 2°C and 8°C, which is much higher and easier to achieve than that of other COVID-19 vaccines requiring lower storage temperatures.
- *Expanded coverage of vaccination.* Inclusion of PIKA has the potential to decrease the amount of spike protein antigen and expand the coverage of vaccination among the general population.

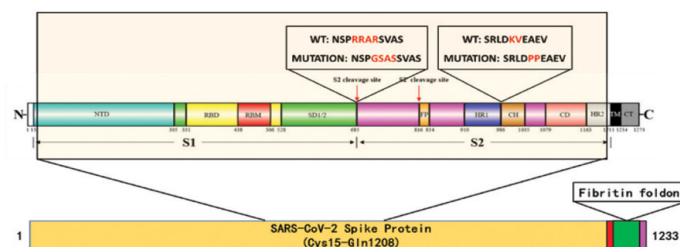
The results from preclinical studies and early stage clinical trials of PIKA recombinant COVID-19 vaccine may not be predictive of the results of later-stage clinical trials.

#### *Summary of Preclinical Results*

##### Full-length Spike Protein modification

The recombinant full-length spike protein is produced using CHO cell expressing system. It is the trimeric S protein that binds to the ACE2 receptor on host cells and mediates the entry of SARS-CoV-2 into the cells. To generate a stable prefusion S trimeric protein structure, several modifications were made, including (1) inserting fibrin foldon (Fd) domain of T4 bacteriophage fibrin protein at the C-terminal of the S protein, which can assist correct assembling and folding of trimerization and stabilize the natural trimer conformation; (2) mutating the Furin restriction site between S1/S2 (RRAR to GSAS, 682-685) to obtain stable prefusion conformation; and (3) inserting two prolines (K986P and V987P) to make S protein more stable. The schematic representation of the structure is shown below.

Figure 6. Schematic Representation of S Trimeric Protein Structure

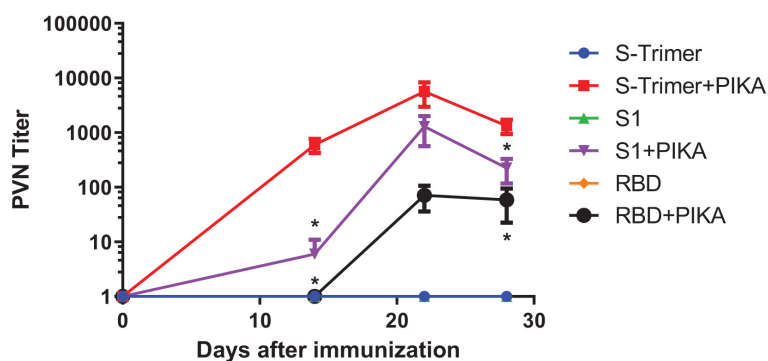


### Antigen selection

To employ the best antigen for further development, YS Group produced three antigens, including full-length S-Trimer protein, S1 domain protein, and RBD. YS Group immunized New Zealand rabbits intramuscularly with 6 µg of each antigen, with and without PIKA adjuvant for three times with one week apart.

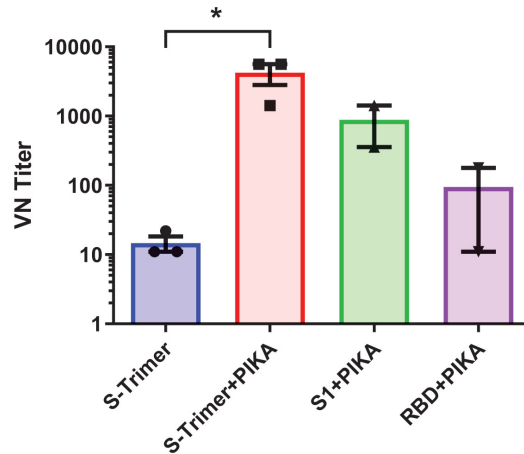
The results have demonstrated that antigen alone without PIKA adjuvant, regardless of the type of antigen, either failed to induce, or induced, modest level of neutralizing antibodies against pseudovirus. In contrast, antigen with PIKA adjuvant significantly enhanced the level of neutralizing antibodies. Among the three antigens, S-trimer performed the best in terms of neutralizing antibody production (Figure 15). YS Group also measured the level of neutralizing antibodies production against wild-type SARS-CoV-2 virus. S-Trimer with PIKA adjuvant elicited higher level of neutralizing antibodies than RBD with PIKA adjuvant (Figure 16).

Figure 7. Level of neutralizing antibodies against pseudovirus in New Zealand rabbits immunized with S-Trimer, S1 protein and RBD



Data are shown as mean  $\pm$  SEM.  $p$ -values were analyzed with a two-way ANOVA (vs. S-Trimer + PIKA,  $*p < 0.05$ ). There is no significant difference between the PIKA adjuvanted groups which were not marked at the same timepoint. Pharmaceutical research is an evidence-based science aiming to apply scientific information retrieved from research experiments and to seek to assess the quality of research results, data or evidence relevant to the risks and benefits of individuals' characteristics or treatments. A statistic approach based on P-value is a common methodology in evaluating such research. A p-value, or probability value, is a number describing how likely it is that your data would have occurred by random chance (i.e. that the null hypothesis is true). The level of statistical significance is often expressed as a p-value between 0 and 1. The smaller the p-value, the stronger the evidence that you should reject the null hypothesis. In terms of applying statistical science in the biological or clinical research, the p-value is the probability of obtaining a result at least as extreme as the one that was actually observed in the biological or clinical experiment or epidemiological study, given that the null hypothesis is true. The "P" value, frequently used to measure statistical significance, is the probability that the study results are due to chance rather than to a real treatment effect. Conventionally,  $p < 0.05$  is referred as statistically significant and  $p < 0.001$  as statistically highly significant. In medical research,  $p$  values less than 0.05 are often reported as statistically significant as it is wanted want there to be only a 5% or less probability that the treatment results, risk factor, or diagnostic results could be due to chance alone. Results that do not meet this threshold are generally interpreted as negative. There is no direct relevance of the statistical significance of such results to evidentiary standard of drug approval as such statistical results were just a small component of decision making process by the regulatory organization and the drug approval process requires substantially more evidences from scientific research, to comprehensive clinical studies to product manufacturing qualification measures.

Figure 8. Level of neutralizing antibodies against wild-type SARS-CoV-2 virus in New Zealand rabbits immunized with S-Trimer, S1 protein and RBD

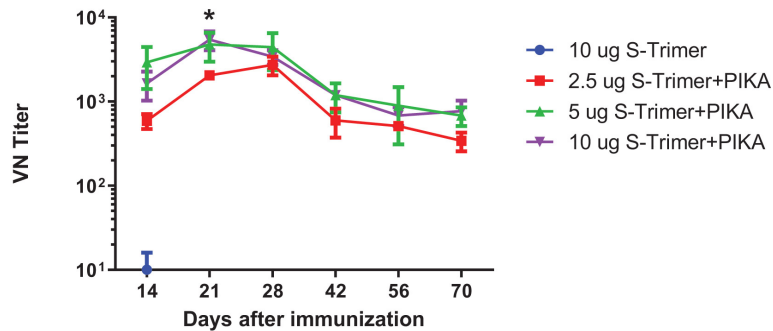


Data are shown as mean  $\pm$  SEM.  $p$ -values were analyzed with a one-way ANOVA ( $*p < 0.05$ ). There is no significant difference between the groups not marked.

### Dose exploration

As the next step, YS Group explored the different dose levels of S-trimer with PIKA adjuvant and assessed the kinetic of neutralizing antibody against pseudovirus. Antigen alone even at the highest dose elicited modest level of antibodies. When PIKA adjuvant was added to S-trimer at dose level of 2.5  $\mu$ g, 5  $\mu$ g and 10  $\mu$ g, all three elicited high levels of neutralizing antibodies, with the level of antibodies induced by 2.5  $\mu$ g of S-trimer slightly lower and 5  $\mu$ g and 10  $\mu$ g of S-Trimer induced comparable level of antibodies (Figure 17).

Figure 9. Level of neutralizing antibodies against pseudovirus in New Zealand rabbits immunized with escalating dose of S-Trimer protein with or without PIKA adjuvant



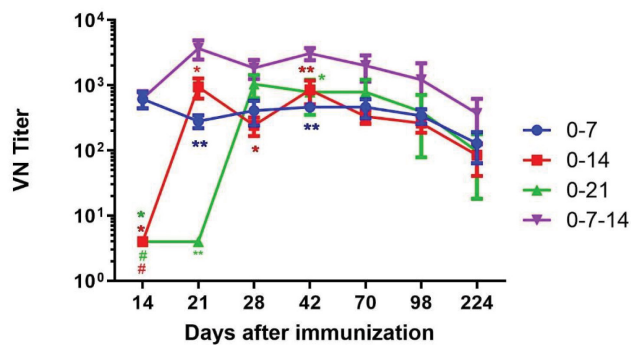
Data are shown as mean  $\pm$  SEM.  $p$ -values were analyzed with a two-way ANOVA (2.5  $\mu$ g of S-Trimer + PIKA compared with 10  $\mu$ g S-Trimer + PIKA,  $*p < 0.05$ ). There is no significant difference between the PIKA adjuvanted groups which were not marked at the same timepoint.

### Dosing schedule exploration

To optimize the dosing regimen, YS Group immunized New Zealand rabbits with 5  $\mu$ g of S-Trimer and 1 mg of PIKA adjuvant using four different dosing schedules, including three two-dose regimens at day 0 and day 7, day 0 and day 14, and day 0 and day 21, and one three-dose regimen at day 0, day 7 and day 14. YS Group measured neutralizing antibodies against wild-type SARS-CoV-2 virus. The three-dose regimen at day 0-7-14 dosing schedule performed best while the three two-dose regimens elicited comparable level antibodies after

day 42. The day 0-7 dosing schedule rapidly elicited high level of antibodies one week after the second dose, which could be advantageous as urgent control during the COVID-19 pandemic.

Figure 10. Level of neutralizing antibodies against wild-type SARS-CoV-2 virus in New Zealand rabbits immunized with S-Trimer with PIKA adjuvant at different dosing schedules

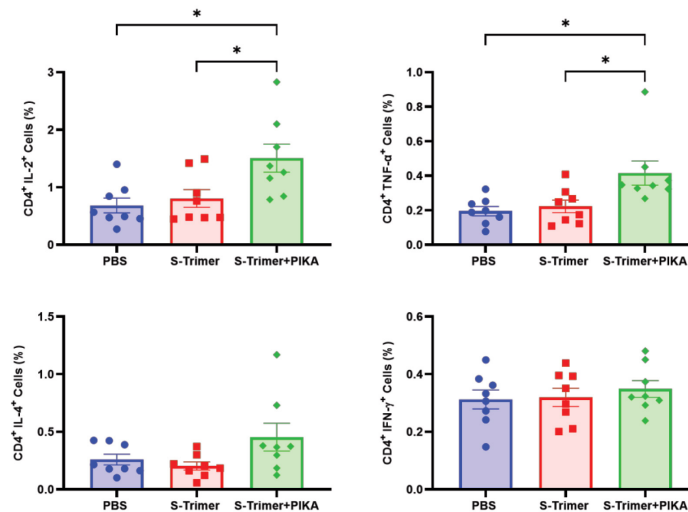


Data are shown as mean  $\pm$  SEM. *P*-values were analyzed with a two-way ANOVA (vs. 0-7-14 group, \**p* < 0.05, \*\**p* < 0.01; vs. 0-7 group, #*p* < 0.05).

### Th1 and Th2 cellular immunity

Antibody dependent enhancement is a risk associated with COVID-19 vaccines. A Th2 dominant cellular immune response is considered contributing factor of antibody dependent enhancement. A balanced Th1/Th2 cellular immune response is preferred to Th1 cellular immune response to decrease the risk of antibody dependent enhancement. YS Group analyzed the T cells expressing Th1 and Th2 typed cytokines (IL2-vs. IL-4) by intracellular cytokine staining. The results suggest PIKA recombinant COVID-19 vaccine induced a balanced Th1 and Th2 cellular immune response.

Figure 11. T cells expressing Th1 (IFN $\gamma$ , IL-2) and Th2 (IL-4, TNF) type cytokines in Balb/C mice immunized with S-Trimer with or without PIKA adjuvant on Days 0, 7 and 14

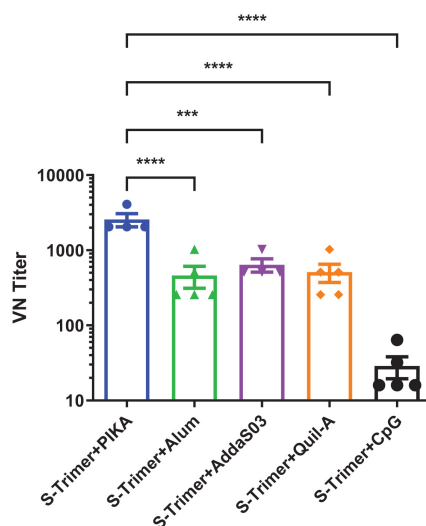


Data are shown as mean  $\pm$  SEM. *p*-values were analyzed with a one-way ANOVA (\**p* < 0.05). There is no significant difference between the groups not marked.

### S-Trimer immunogenicity.

PIKA adjuvant is superior to other types of adjuvants in augmenting S-Trimer immunogenicity. Groups of New Zealand rabbits were immunized on days 0 and 7 with 5 ug S-Trimer in combination with different adjuvants including Alum, AddaSO3, Quil-adjuvant, and CpG. YS Group measured wild-type SARS-CoV-2 neutralizing antibodies 14 days after initial immunization. The results have indicated that PIKA performed best in terms of adjuvanting S-Trimer antigen (Figure 20).

Figure 12. Wild-type SARS-CoV-2 virus neutralizing antibodies in animal serum at day 14 post-immunization in New Zealand rabbits immunized with S-Trimer in combination with different adjuvants



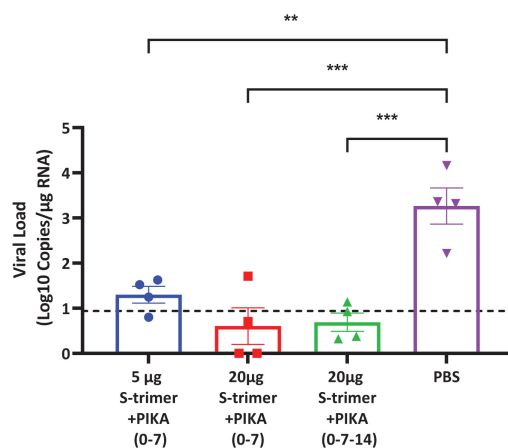
Data are shown as mean  $\pm$  SEM.  $p$ -values were analyzed with a one-way ANOVA (\*\* $p < 0.001$ , \*\*\*\* $p < 0.0001$ ). There is no significant difference between the groups not marked.

### Protective activity

To demonstrate the protective activity of PIKA recombinant COVID-19 vaccine, 16 cynomolgus monkeys were randomly divided into four groups, among which the control group, the low-dose group and the high-dose group 1 adopted immunization regimen 0-7 (that is, immunized once each day on day 0 and day 7); while the high-dose group 2 adopted immunization regimen 0-7-14 (that is, immunized once each day on day 0, day 7 and day 14). All four treatment groups were challenge tested with COVID-19 (SARS-CoV-2) 7 days after the last immunization. As indicated in Figure 21, the result of the monkey study has shown that the three vaccinated groups had significantly lower viral load than the control group, which means that vaccination using PIKA recombinant COVID-19 vaccine can significantly inhibit virus replication and demonstrates good preventive effect. In addition, viral load decrease is correlated with the dose: the higher the antigen dose, the more times the monkeys receive immunization, and the further decrease in viral load.



Figure 13. COVID-19 viral load in the lungs of cynomolgus monkeys 7 days after challenge

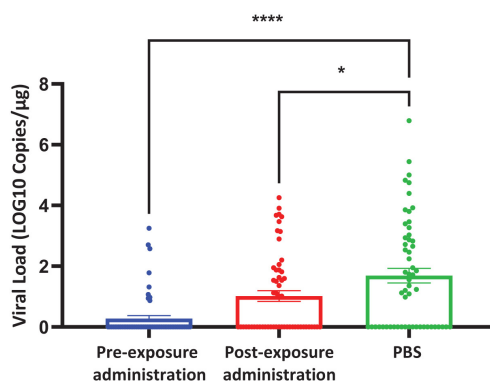


Data are shown as mean  $\pm$  SEM. The horizontal dashed line indicates the limit of detection. Significance was calculated using one-way ANOVA (\*\* $p < 0.01$ ; \*\*\* $p < 0.001$ ). There is no significant difference between the groups not marked.

### Therapeutic activity

To demonstrate the therapeutic activity of PIKA recombinant COVID-19, 12 cynomolgus monkeys were randomly divided into three groups, including pre-exposure, post-exposure and controlled groups. The control group and the pre-exposure dosing group were dosed every day from the fifth day prior to the challenge, attacked with COVID-19 (SARS-CoV-2) after five days of consecutive dosing, and dosed for seven consecutive days since the day of the challenge. The post-exposure dosing group was not dosed prior to the challenge and only dosed since the day of the challenge for seven consecutive days. As indicated in Figure 22, the post-exposure vaccinated group had significantly lower viral load than the control group, which indicates that vaccination using PIKA recombinant COVID-19 vaccine can significantly inhibit virus replication and demonstrates significant therapeutic effect.

Figure 14. COVID-19 viral load in the lungs of cynomolgus monkeys 7 days after challenge



Data are shown as mean  $\pm$  SEM. Significance was calculated using one-way ANOVA (\* $p < 0.05$ ; \*\*\*\* $p < 0.0001$ ).

### *Phase I Clinical Trial in UAE*

YS Group completed patient enrollment of Phase I trial of PIKA recombinant COVID-19 vaccine in the United Arab Emirates with preliminary results in the first half of 2022. Phase I clinical trial is designed to evaluate the safety, tolerability and immunogenicity of PIKA recombinant COVID-19 vaccine in healthy adults. This is a Phase I, open label, dose-escalation study of three dose levels of the SARS-CoV-2 spike

antigen administered intramuscularly (IM) in combination with a fixed dosage of PIKA adjuvant vaccine to evaluate the safety, tolerability, and immunogenicity of PIKA COVID-19 vaccine candidate in healthy individuals aged over 18 years. Three dose levels, namely 5ug, 10ug and 20ug of recombinant spike protein with 1mg PIKA, were administered via intramuscular injections. The study comprised of two arms. Arm A included subjects without history of COVID-19 vaccination and Arm B included subjects who will be receiving PIKA vaccine as a booster vaccination dose to those who had primary series of inactivated vaccines or mRNA vaccines. For Arm A, a total of 45 subjects were enrolled. Subjects in Group 1-3 received two doses of PIKA COVID-19 vaccine via IM administration on Days 0 and 7. For Arm B, a total of 90 subjects were enrolled and were further divided into Arm B1 (45 subjects) and Arm B2 (45 subjects). Arm B1 enrolled subjects who received COVID-19 inactivated vaccines as primary series and comprised of 15 subjects per dose (45 subjects). Arm B2 enrolled subjects who received mRNA vaccines as primary series and comprised of 15 subjects per dose (45 subjects). Subjects in Group 1-3 of Arm B1 and Arm B2 received one booster dose of PIKA COVID-19 vaccine via IM administration on Day 0. The primary endpoints included evaluation of safety as to solicited and unsolicited adverse events, serious adverse events, and adverse events of special interests; the secondary endpoints included evaluation of immunogenicity at GMTs and seroconversion rate differences of the neutralizing antibodies against the original strain and variants of concerns of SARS-CoV-2, and cell-mediated immune responses..

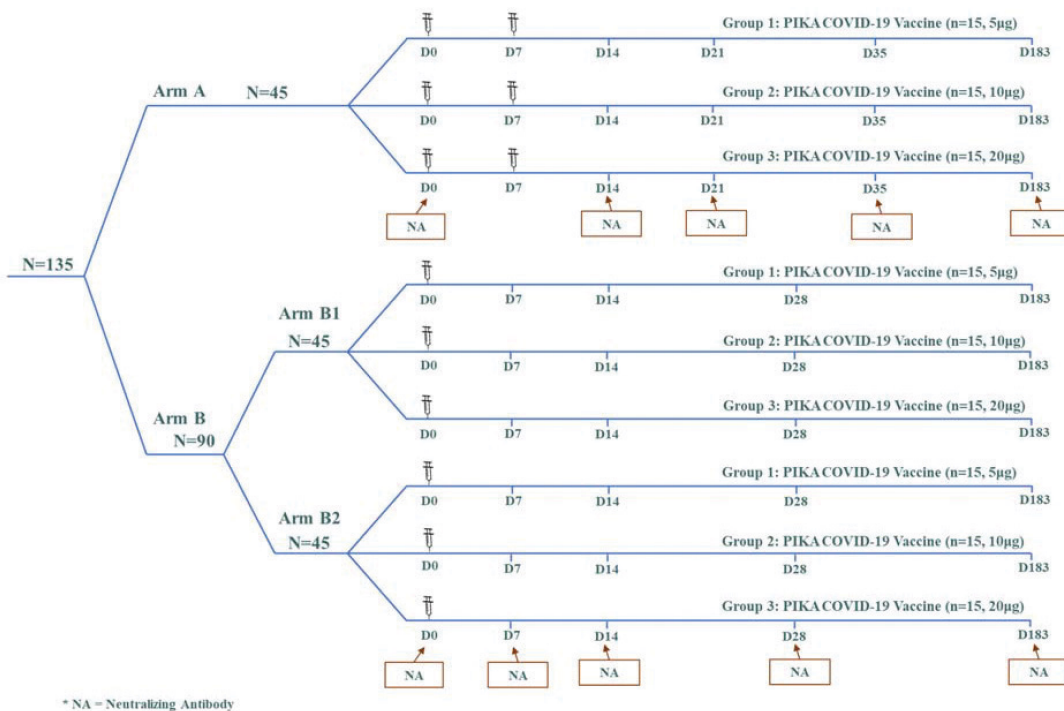
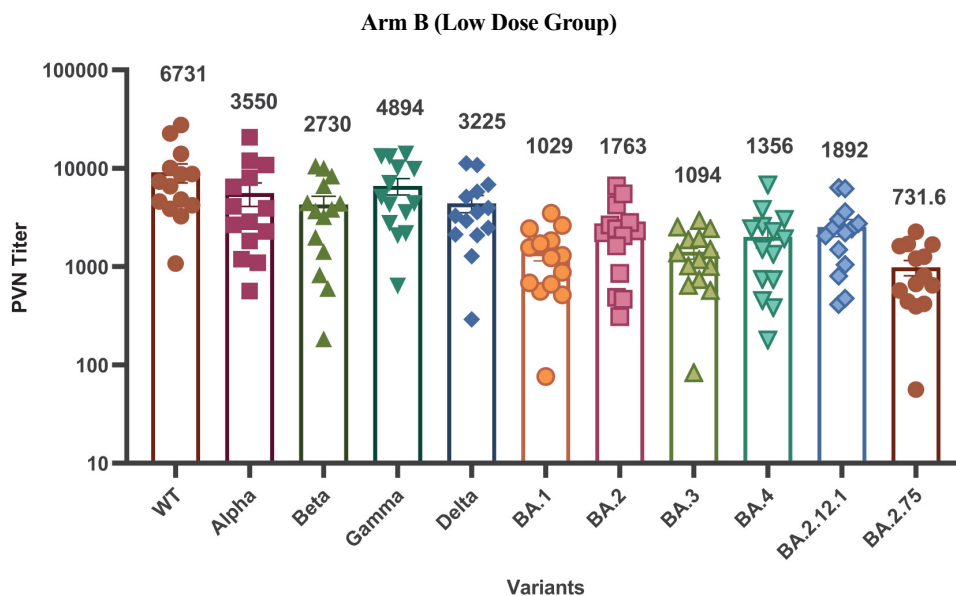


Figure 15. Schematic Diagram of Phase I Study Design

Arm	Subjects	Age	Regimen	Antigen Dosage	Sample Size
Arm A (Prime)	Subjects without history of COVID-19 vaccination	≥18 years	Two shots (Day 0,7)	5µg	15
				10µg	15
				20µg	15
Arm B (Booster)	Subjects who had completed the primary series of inactivated COVID-19 vaccination	≥18 years	One shot	5µg	15
				10µg	15
				20µg	15
	Subjects who had completed the primary series of mRNA COVID-19 vaccination	≥18 years	One shot	5µg	15
				10µg	15
				20µg	15

The clinical trial also evaluated the neutralizing antibody titers of Arm B (low dose group) for other SARS-CoV-2 variants. Immunogenicity testing 14 days after the booster dose demonstrated that the neutralizing antibody titer against BA.2 in the serum of the subjects in the low dose group of Arm B reached 1,763 and the titer against BA.4/5 was as high as 1,356. Whereas before vaccination, the neutralizing antibody titer against BA.2 and BA.4/5 in the same groups were 31.81 and 23.5 respectively.

Figure 16. Neutralizing antibody titer of PIKA COVID-19 vaccine (5 µg/dose) 14 days post vaccination (PVNT)



Data are shown as mean  $\pm$  SEM. Significance was calculated using one-way ANOVA, (vs. WT group, all other groups  $p < 0.01$ ).

In the Phase I clinical trial, no safety concerns were revealed. No deaths and vaccine-related serious adverse events were reported. Preliminary results of Phase I study of PIKA recombinant COVID-19 vaccine showed that as basic immunization and sequential booster immunization, PIKA recombinant COVID-19 vaccines can induce the production of high-level neutralizing antibodies, which are effective for a variety of mutant strains, including Delta, Omicron sublineages BA.1, BA.2, BA.3, BA.4/5 and BA 2.12.1.

#### *Phase II and III Clinical Trials in the UAE and Philippines*

A Phase II and III, Randomized, Double-blinded Study is designed to evaluate the Efficacy, Safety and Immunogenicity of a Booster Dose of PIKA-Adjuvanted Recombinant SARS-CoV-2 Spike (S) Protein Subunit Vaccine in Adults  $\geq 18$  Years Old Who Received 2 or more doses of Inactivated Covid-19 Vaccine.

Primary objectives in Phase II of the study are to assess the immunogenicity of PIKA COVID 19 vaccine 14 days after the booster dose and compare to the comparator inactivated COVID 19 vaccine. It is also aimed to demonstrate the immunogenic superiority of the PIKA COVID 19 vaccine on day 7 post booster dose. In Phase III trial, the efficacy and safety of PIKA COVID 119 vaccine in comparison to that of the comparator inactivated COVID 19 vaccine will be compared.

In Phase II, a total of 300 eligible subjects were allocated in a 1:1 ratio, stratified by age group ( $< 60$  years old vs.  $\geq 60$  years old) to receive PIKA COVID-19 vaccine or the comparator inactivated COVID-19 vaccine. The ratio of the GMT of neutralizing antibody on Day 14 after the booster dose of PIKA COVID-19 vaccine group and inactivated COVID-19 vaccine group will be calculated. Among 300 subjects, at least 200 subjects were enrolled as subset of long-term immunogenicity and 100 subjects were enrolled as subset of early immunogenicity. Among the 100 early immunogenicity subset, the ratio of the GMT of neutralizing antibody on Day 7 after the booster dose of PIKA COVID-19 vaccine group and inactivated COVID-19 vaccine group will be calculated.

Primary objectives in Phase III of the study are to assess the efficacy and safety of PIKA Covid-19 vaccine compared to the comparator inactivated COVID-19 vaccine. The secondary objectives in Phase III study are to assess the long-term safety and immunogenicity of PIKA COVID-19 vaccine compared to the comparator inactivated COVID-19 vaccine. In phase III, total 5,656 eligible subjects were randomly allocated in a 1:1 ratio

to the PIKA COVID-19 vaccine group or the inactivated COVID-19 vaccine group, stratified by age group (< 60 years old vs. ≥ 60 years old). Among total subjects, at least 6% subjects were enrolled as subset of immunogenicity. Long term safety and immunogenicity will also be evaluated.

#### Study Design and Subject Allocation

Trial Design and Subject Allocation					
Phase	N	Immunogenicity Set	Vaccine	Vaccination	Blood Draws
II	150	Early: 50 Long Term: 100	PIKA COVID 19	Day 0	D0, 7, 14, 90, 180, 360
	150	Early: 50 Long Term: 100	Inactivated COVID 19	Day 0	
III	5656	6% of the subjects	PIKA COVID 19	Day 0	D0, 7, 14, 360
			Inactivated COVID 19	Day 0	
<b>Total</b>	<b>5956</b>				

#### *PIKA YS-HBV-001*

PIKA YS-HBV-001 is a hepatitis B vaccine composed of genetically engineered recombinant hepatitis B surface antigen protein (HBsAg) and PIKA adjuvant, with the potential to become a hepatitis B vaccine with accelerated regimen. YS Group has completed the Phase I clinical trial of PIKA YS-HBV-001 in Singapore in 2017, which has demonstrated good reactogenicity and tolerability and immunogenicity under accelerated regimen. YS Group expects to enter into Phase II trials in Singapore in 2023.

#### Mechanism of action

HBV infection can cause morbidity and mortality, including acute hepatitis necrosis and chronic active hepatitis. Patients with chronic HBV infection are at higher risk of cirrhosis and hepatocellular cancer. A concentration of antibody against HBsAg ::10 mIU/mL can confer protection against HBV infection. PIKA YS-HBV-001 can elicit high-level specific antibodies and robust and multifunctional cellular immune response to prevent HBV infection. PIKA adjuvant acts as an immunomodulating agent on innate immune receptors for sensing the presence of virus infection. Those receptors are expressed in dendritic cells (DCs), which are the most potent antigen presenting cells. When combining PIKA with HBsAg in PIKA YS-HBV-001, PIKA activates DCs to secrete interferon and cytokines, converts immature DCs to mature DCs for efficiently presenting HBsAg antigen to CD4+ T cells, and promotes T cell differentiation to functional helper T (Th) cells. Those helper T cells in turn provide multiple signals to B cells specific for HBsAg, generating antibody responses to provide protective immunity to HBV. Long-lived antibody response and T and B cell memory are able to provide persistent protection against HBV infection.

#### Market opportunity and competition

Hepatitis B is an infectious illness caused by HBV, which infects the liver and causes inflammation, scarring and, in some cases, liver cancer. The disease is a major health concern worldwide, particularly in Asia and Africa. Common prevention methods for HBV includes HBV preventative vaccines, antiviral prophylaxis during pregnancy, screening of donated blood and HBV diagnosis.

According to the Global Hepatitis Report 2017 issued by the WHO, 257 million people, or 3.5% of the world population, were living with chronic HBV infection, and 0.9 million people died due to the complications of chronic HBV infections in 2015. In addition, certain chronic patients may develop cirrhosis, liver failure or

hepatocellular cancer. An estimated 600,000 people die each year due to chronic consequences of HBV infection, such as cirrhosis and hepatocellular cancer, in addition to the approximate 40,000 deaths from the acute illness, according to the same source.

According to the F&S Report, an estimate of 70.3 million people were infected with chronic HBV in China in 2021. This high prevalence of infection has prompted the Chinese government to increase its efforts in treating those suffering from chronic hepatitis B and strengthen its hepatitis B immunization program. In addition, the current diagnosis and treatment rate in China is relatively low at 32.1% and 21.1% in 2019, respectively. Lot release of hepatitis B prophylactic vaccine in China was 70.7 million in 2021, and is expected to reach 85.4 million in 2025 and further to 90.8 million in 2030, according to the same source.

YS Group believes PIKA YS-HBV-001 has advantages over current available hepatitis B vaccines in the market. See “— YS Group’s Marketed Product and Product Candidates — YS Group’s Clinical Stage Product Candidates — PIKA YS-HBV-001 — Advantages.” YS Group has completed the Phase I clinical trial of PIKA YS-HBV-001 in Singapore. YS Group plans to proceed with more advanced clinical studies in China and other countries.

According to the NMPA and the F&S Report, there were nine marketed hepatitis B prophylactic vaccine products in China as of December 31, 2021. According to the CDE and the F&S Report, there were five hepatitis B prophylactic vaccine pipelines in China as of December 31, 2021.

### Advantages

The major marketed prophylactic hepatitis B vaccine products in China contain a recombinant HBsAg with an aluminum salt, and are administered as a series of three doses over six months. Most adults who did not receive hepatitis B vaccination as an infant or adolescent may be at risk of being infected with HBV. However, the challenge of successful vaccination of adults against HBV still remains, including poor adherence to a complete three-dose vaccination schedule over six months and low protective antibody production especially when the full course of vaccination cannot be achieved. The current hepatitis B vaccines have the following limitations:

- *Low protective antibodies.* The existing prophylactic hepatitis B vaccine failed to induce sufficient amount of protective antibodies in some individuals. Certain patient cohorts are more susceptible to hepatitis B and do not respond well to standard vaccination programs. End-stage renal disease patients on hemodialysis have a higher prevalence of HBV infection and poorer prognosis than the general population. However, vaccination against HBV proposed for uremic patients or pre-transplant patients shows vaccine seroconversion rates significantly lower than immunocompetent individuals. Even at anti-hepatitis B antibody protective levels, this patient population has lower peak antibody titers and lower hepatitis B antibody levels as well as shorter duration of immunity.
- *Long-term and overall low success rates.* Current prophylactic hepatitis B vaccines for adults usually require three doses given over six months to provide seroconversion of approximately 30%, 70% and 90% after the first, second and third dose, respectively. The effectiveness of current vaccines is further compromised because many people fail to receive all three doses. Vaccine is less effective in patients that are already on dialysis and a protective anti-hepatitis B level develops in only approximately 55% of recipients when the 40ug dose (double dose) regimen is used.

To overcome the limitations of the current vaccines, YS Group has developed PIKA YS-HBV-001 to reduce regimen duration and confer comparable or better protection against HBV infection. Two doses of HBV-001 given within one month will also potentially improve the compliance and reduce the cost of immunization. In preclinical studies comparing vaccines of HBsAg, YS Group has demonstrated that its PIKA-adjuvant PIKA YS-HBV-001 significantly increased the production of HBsAg antibodies as compared with aluminum-adjuvant HBsAg vaccine. PIKA YS-HBV-001 significantly enhanced T cell mediated immune response in mice, and was able to induce the production of IFN- $\gamma$  secreting CD4+ and CD8+ T cells. The immune effect of PIKA YS-HBV-001 is superior to the existing non-adjuvant vaccine and alum- adjuvant vaccine. Moreover, PIKA YS-HBV-001 may realize multi-functional T cell induction. Phase I clinical studies have demonstrated that PIKA YS-HBV-001 has the potential to induce the production of multi-functional T cells in human, compared to Engerix, a marketed product, which primarily induced mono-functional T cells. The production

of multi-functional T cells enables PIKA YS-HBV-001 to induce more robust and lasting T cell response, promote IFN and cytokine production and achieve accelerated and high seroconversion.

#### Summary of preclinical and clinical results

PIKA YS-HBV-001 has completed the Phase I clinical trial in Singapore with 32 healthy naive adult subjects enrolled in the study.

#### Preclinical study

The results from Balb/c mice study comparing vaccines of HBsAg without adjuvant and vaccines with alum-adjuvant HBsAg indicated that PIKA YS-HBV-001 substantially increased HBsAg-specific IgG production in mice compared with those immunized with HBsAg alone or with HBsAg plus alum adjuvant ( $p < 0.05$ ). In addition, YS-HBV-001 enhanced T cell mediated immune response in mice, and was able to induce the production of IFN- $\gamma$  secreting CD4 $^{+}$  and CD8 $^{+}$  T cells. The immunogenicity of PIKA YS-HBV-001 was superior to the existing adjuvant-free vaccine and alum-adjuvant vaccine. PIKA YS-HBV-001 was well tolerated in rhesus monkeys and showed good immunogenicity.

Figure 17. IFN- $\gamma$  Secreting T Cells by ELISpot after vaccination in mice

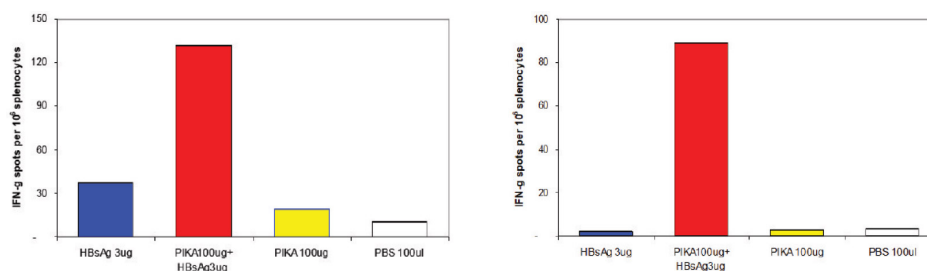
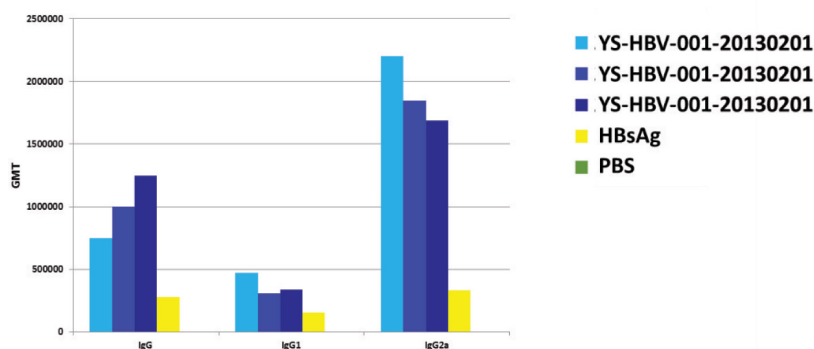


Figure 18. Anti-HBsAg antibody titers after vaccination in mice

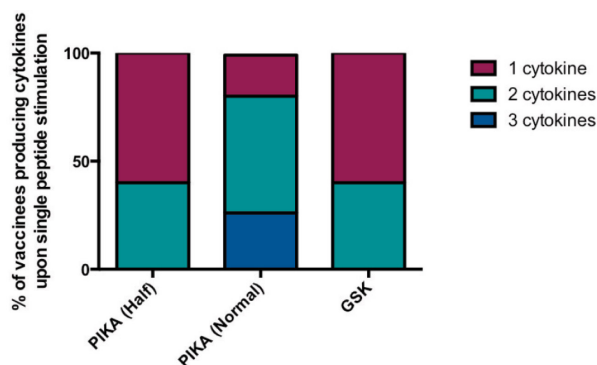


#### Phase I clinical trial

The Phase I clinical trial of PIKA YS-HBV-001 was conducted in Singapore to evaluate the safety and immunogenicity of PIKA YS-HBV-001. This study was a randomized, double blind, active control and parallel group study with the enrollment of 32 healthy naive adult subjects aged from 21 to 65 years. Three groups were enrolled in this study, including (1) half dose (20 ug HBsAg) plus 500 ug PIKA dosed on days 0, 28 and 56; (2) normal dose (40 ug HBsAg) plus 1000 ug PIKA dosed on days 0, 28, and 56, and (3) an Engerix comparator, namely 20 ug HBsAg plus 500 ug alum dosed on days 0, 28 and 168. The study has shown that the seroconversion rate was comparable between shortened regimen of PIKA YS-HBV-001 and the standard regimen of commercially available vaccine (ENGERIX-B vaccine) in the control arm. No death and no vaccine-related serious adverse events were reported. No clinically meaningful changes were identified in

biochemical, hematological, vital signs and physical examination. The data indicate that PIKA YS-HBV-001 has a good safety and tolerability profile. There was also indication that higher seroconversion could be induced earlier by PIKA YS-HBV-001 than ENGERIX-B vaccine. PIKA YS-HBV-001 was also able to induce a higher magnitude, more robust and lasting T cell response compared to ENGERIX-B vaccine. In particular, PIKA YS-HBV-001 at normal dose can induce multi-functional T cells, which are considered significant in clearing virus-infected cells. PIKA YS-HBV-001 has similar safety and tolerability as compared to the commercially available vaccine in the control arm. The following table sets forth the seroconversion rate at different time points after vaccination with PIKA YS-HBV-001 or ENGERIX-B.

Figure 19. Percentage of vaccines producing cytokines upon single peptide stimulation



Visit (Day)	Seroconversion Rate (%)		
	Low dose HBV-001	High dose HBV-001	ENGERIX-B
Baseline	0	0	0
D 56	87.5	100	66.7
D 84	90	100	66.7
D 196	90	100	88.9

#### *PIKA YS-ON-001*

PIKA YS-ON-001 is a multiple component complex of proteins and PIKA that can reduce the immunosuppressive effect of the tumor microenvironment and enhance the anti-tumor activity of the immune system against tumor cells. YS Group is currently independently developing PIKA YS-ON-001 as an immuno-oncology therapeutic. PIKA YS-ON-001 has demonstrated, in multiple animal models, strong anti-tumor activities as a standalone therapy and when combined with other therapeutic agents, such as kinase inhibitors, antibody blocking programmed death receptor-1 (PD-1) against a slew of advanced solid tumors, including hepatocellular cancer, breast cancer, lung cancer, colorectal cancer and prostate cancer. The U.S. FDA also granted PIKA YS-ON-001 two ODDs for the treatment of pancreatic cancer and hepatocellular cancer.

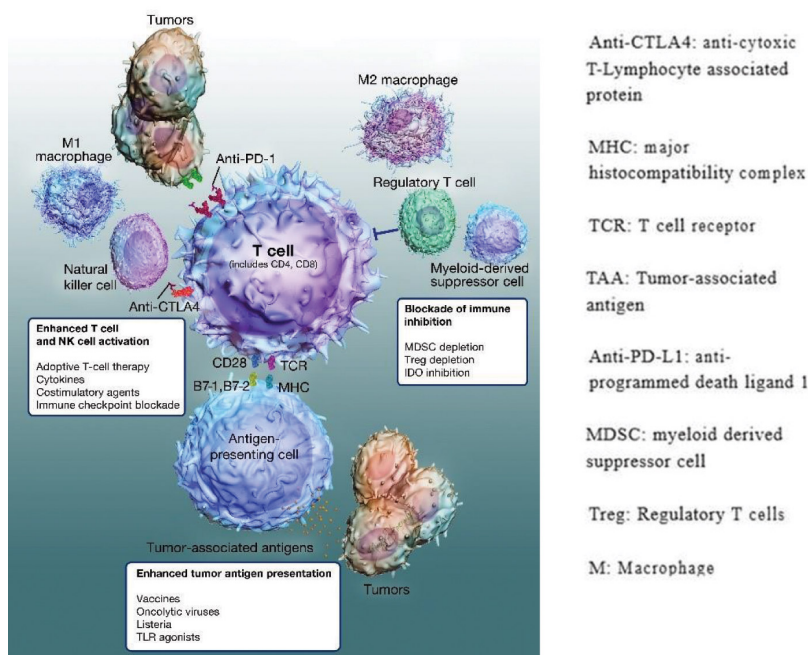
With respect to PIKA YS-ON-001, the Company commenced the cancer patient enrollment for the Phase I clinical study in China in December 2021, focusing on the safety study on late-stage breast cancer, lung cancer, liver cancer and melanoma subjects.

#### *Mechanism of action*

The effectiveness of immuno-oncology therapy often depends on the interaction of tumor cells with immune regulation within the tumor microenvironment. Under these interactions, the tumor microenvironment plays an important role in inhibiting or enhancing the immune response. YS Group believes that an effective immunotherapy against cancer requires multimodal approaches that target different aspects of the antitumor response (see Figure 6), such as tumor antigen recognition, T cell activation, NK cell activation and blockade of immune inhibitory pathways.

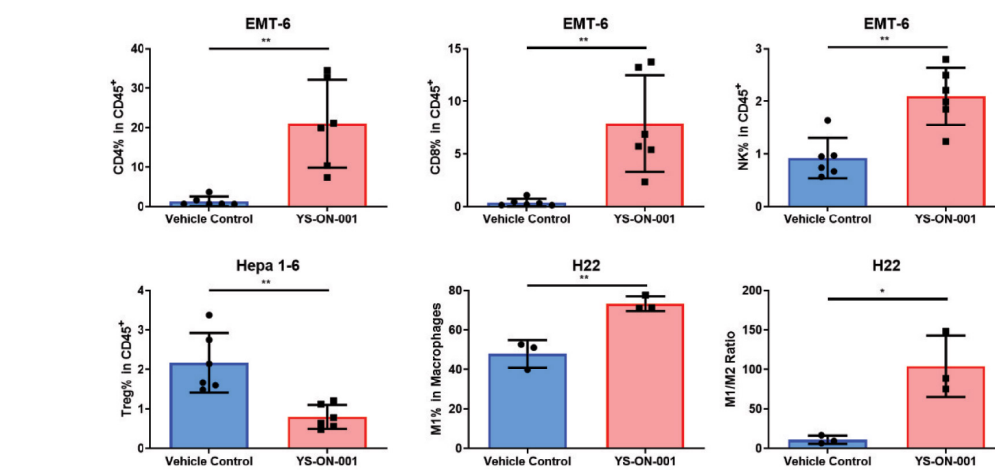


Figure 20. Multimodal approaches of cancer immunotherapy



PIKA YS-ON-001 is YS Group's proprietary immunotherapeutic agent based on the TLR3/RIG- I/MDA5 signaling pathway of PIKA immunomodulating technology. It can significantly enhance the phagocytosis of macrophages, upregulate the activation of DC cells, NK cells and T cells, induce the production of multiple tumor-inhibitory cytokines and tumor cell apoptosis, and improve the host immune response. The effectiveness of immuno-oncology therapy often depends on the interaction of tumor cells with immune regulation within the tumor microenvironment. Under these interactions, the tumor microenvironment plays an important role in inhibiting or enhancing the immune response. YS Group believes that an ideal immunotherapy against cancer requires multimodal approaches that target different aspects of the antitumor response, such as tumor antigen recognition, T cell activation, NK cell activation and blockade of immune inhibitory pathways (see Figure 6). Preclinical tumor microenvironment immune regulatory studies have shown that besides of increasing CD4+ and CD8+ T cell responses, PIKA YS-ON-001 can also significantly increase the proportion of NK and NKT cells in the tumor microenvironment. In several tumor models, PIKA YS-ON-001 can significantly reduce the number of Tregs in tumor microenvironment. At the same time, YS-ON-001 can reprogram tumor-associated macrophages (TAMs) from a protumor M2 phenotype to an antitumor M1 phenotype. The studies have indicated that YS-ON-001 could weaken the immunosuppressive effect of tumor microenvironment and enhance the killing function of immune system to tumor cells. With the multiple modes of action of PIKA YS-ON-001, YS Group believes PIKA YS-ON-001 has the potential to become an integral immunotherapy component with standard of care chemotherapies, targeted therapies and checkpoint inhibitors or with other emerging immunotherapies that produce additive or synergistic treatment benefits.

Figure 21. Frequency of immune cells in EMT-6, Hepa 1-6, and H22 tumors from mice•



Data are shown as mean ± SEM. Significance was calculated using unpaired *t*-test (\* $p < 0.05$ , \*\* $p < 0.01$ ).

EMT-6: mouse breast cancer cell; Hepa 1-6: mouse liver cancer cell; H22: mouse liver cancer cell

### Market opportunity and competition

Due to factors such as alcohol abuse, HBV and hepatitis C virus infections, the incidence of hepatocellular cancer in China increased from approximately 351,100 in 2017 to 388,000 in 2021, and is expected to reach 474,200 in 2030, according to the F&S Report. The incidence of pancreatic cancer in China increased from approximately 101,500 in 2017 to approximately 115,900 in 2021, and is expected to reach approximately 155,800 in 2030, according to the same source. According to the WHO, the number of new cases is expected to rise by approximately 70% over the next two decades.

Immuno-oncology is a rapidly growing field in cancer treatment that focuses on modulating the immune system to stimulate or enhance anti-tumor activities to inhibit growth or eliminate tumors. Multiple strategies and technologies have been explored to enhance and prolong anti-tumor immune responses. Agents that inhibit two of these immune checkpoints, CTLA-4 and the PD-1/PD-L1 interaction, have recently been approved for a number of cancer indications. These checkpoint inhibitors represent a major advancement in cancer treatment, but a majority of patients fail to respond to these inhibitors used as single agents, which represents a significant opportunity to develop new immunotherapy with multiple immunomodulating functions in order to change the tumor microenvironment, enabling remission and durable control of tumor growth.

Emerging immunotherapies, such as checkpoint inhibitors, engineered T cells and therapeutic vaccines, will drive the market expansion of cancer treatment. The immuno-oncology market in China grew rapidly from RMB0.9 billion in 2017 to RMB16.3 billion in 2021 at a CAGR of 108.2%, and is projected to reach RMB63.8 billion in 2025 at a CAGR of 40.6% from 2021 to 2025, and further to RMB256.4 billion at a CAGR of 32.1% from 2025 to 2030, according to the F&S Report.

According to the F&S Report, there were six immune-oncology therapies targeting TLR3/MDA5/RIG-I globally as of July 31, 2022, and there had been no such therapy under development in China as of July 31, 2022.

### Advantages

Current available immune-oncology therapeutic biologics in China and the global markets mainly include monoclonal antibodies, bispecific antibodies, cytokines and therapeutic cancer vaccines, according to the F&S Report. YS Group's research has indicated that PIKA YS-ON-001 has the following potential advantages and benefits that differentiate it from currently available immuno-oncology therapeutic biologics:

- **Broad spectrum of anti-tumor activity.** Unlike PD-1 related checkpoint inhibitors, which tend to be more effective among patients with high PD-L1 expression on tumor cells, PIKA YS-ON-001 is a multi-target immuno-oncology drug and offers broad spectrum of anti-tumor activities, including hepatocellular cancer, lung cancer, breast cancer, colorectal cancer, prostate cancer, pancreatic cancer, lymphoma and melanoma. Figure 8 below (not head-to-head) represented the tumor growth inhibition (TGI) of multiple mice tumor models treated with PIKA YS-ON-001, anti-PD-1 or anti-PD-L1 antibodies. Treatment with PIKA YS-ON-001 significantly lowered the tumor weight and resulted in >50% inhibition rate, which was more efficient than anti-PD-1 or anti-PD-L1 antibodies. Figure 9 below showed enhanced anti-cancer activity of PIKA YS-ON-001 when in combination with anti-PD-1 antibody.

Figure 22. TGI of mouse tumor models treated with PIKA YS-ON-001, anti-PD-1 or anti-PD-L1

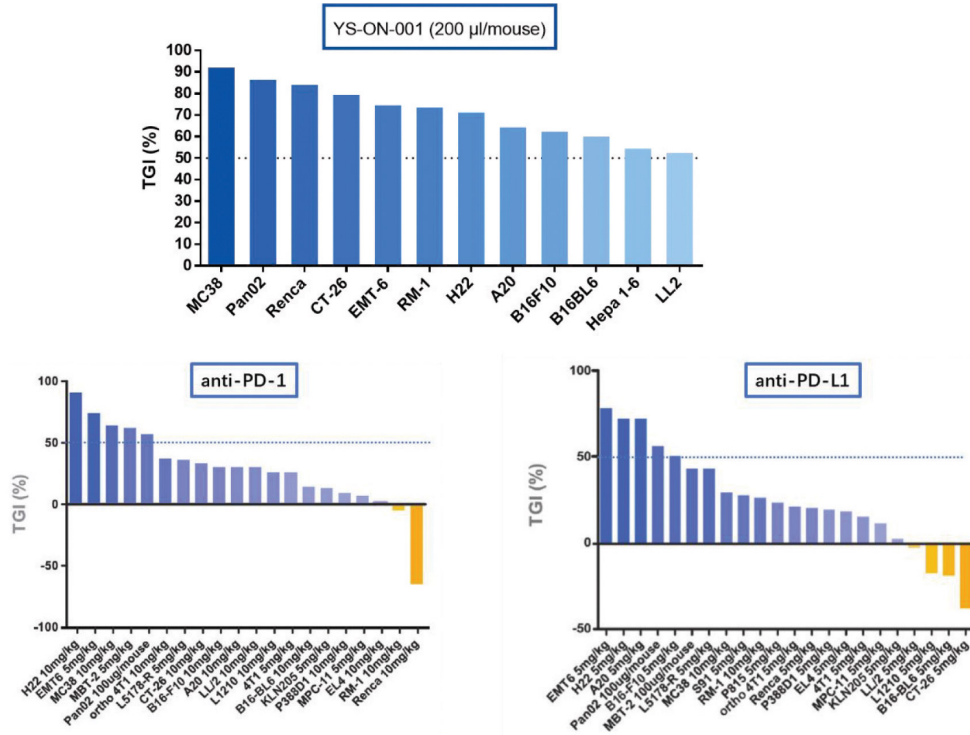
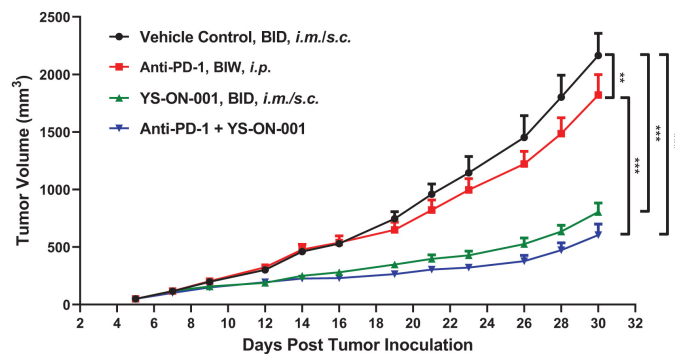


Figure 23. Enhanced anti-tumor activity of PIKA YS-ON-001 with anti-PD-1 antibody



Data are shown as mean ± SEM. *P*-values were analyzed with a two-way ANOVA (\*\**p* < 0.005, \*\*\**p* < 0.001)

- *Potential to be used in combination with cancer therapies available in the market.*
  - (1) *Combination with radiotherapy (RT):* RT has been one of the three major traditional treatments for cancer patients to provoke important responses not only at the site of treatment but also on remote, non-irradiated tumor deposit, namely the abscopal effect. Radiation damaged cells can activate antigen presenting cells and induce maturation of dendritic cell to efficiently present tumor antigen to T cells. In combination with RT, PIKA YS-ON-001 has the potential to act as immune-modulator to enhance tumor specific immune response.
  - (2) *Combination with targeted therapies:* YS Group's study has demonstrated that PIKA YS-ON-001 enhanced the anti-cancer activity when combined with sorafenib, a multikinase inhibitor. YS Group believes PIKA YS-ON-001 has the potential to be combined with various targeted therapies.
  - (3) *Combination with checkpoint inhibitors:* PIKA YS-ON-001 can significantly enhance the PD-L1 expression in tumor cells, which in most tumors are favored for PD-1 blockers to achieve high response rate. By combining PD-1 blockers, PIKA YS-ON-001 could enhance the therapeutic effect of PD-1 blocker, especially in those tumors that express no or low level of PD-L1 or are refractory to PD-1 blocker treatment.
  - (4) *Combination with oncolytic viruses:* Oncolytic virus therapy is emerging as a new approach in cancer treatment and oncolytic viruses are self-replicating, tumor selective and can directly lyse cancer cells. The damaged tumor cells could activate specific immune response to tumors which could be leveraged by PIKA YS-ON-001 to further enhance immune responses.
  - (5) *Combination with chemotherapies:* PIKA YS-ON-001 could also be combined with chemotherapy. Tumor antigen released from damaged tumor cells upon exposure to cytotoxic therapeutic agents can be captured by PIKA YS-ON-001 activated DCs and enhance the overall anti-tumor effects.
- *Potential to have better safety profile and marketability.* Adoptive cell-based immunotherapy, such as CAR-T and other in vitro modification of immunological cells, tends to have significant side effects, high level of technical complexity and difficulty in quality control and commercialization. Unlike these products, PIKA YS-ON-001 is expected to activate the patient's own cellular immune response by modulating tumor microenvironment. YS Group expects PIKA YS-ON-001 to have a better safety profile and marketability.

#### Summary of preclinical and clinical results

##### Preclinical results

The following table summarizes the preclinical study results of PIKA YS-ON-001's superior anti-tumor activities as compared to the standard cares of cancer treatment, measured by Treatment/Control (T/C)(%) and tumor inhibition rate (IR) of PIKA YS-ON-001 in advanced solid tumors animal models.

Animal Model	Agent	T/C (%)	IR (%)
Breast cancer 4T1 in-situ model	PIKA YS-ON-001	45.87	42.26
	Docetaxel	50.12	35.55
Lewis lung cancer LL/2 transplanted tumor model	PIKA YS-ON-001	37.02	60.88
	Cisplatin PIKA	47.46	42.38
	YS-ON-001+Cisplatin	28.38	75.44
Liver cancer H22 transplanted tumor model	PIKA YS-ON-001	18.84	73.40
	Sorafenib PIKA	36.79	53.73
	YS-ON-001+Sorafenib	12.56	88.19
Colon cancer CT-26 transplanted tumor model	PIKA YS-ON-001	5.38	97.71
	PD-1	53.66	47.05
Prostate cancer RM-1 transplanted tumor model	PIKA YS-ON-001	1.39	98.56
	PD-1	57.62	38.12
Melanoma B16-F10 Metastatic tumor model			

### Phase I clinical trial

The Phase I clinical trial of PIKA YS-ON-001 is an open label, dose escalation and cohort expansion study in patients with advanced solid tumors. The objective of the Phase I clinical trial is to evaluate the safety and tolerability of YS-ON-001 in patients with advanced solid tumors who have limited available treatment options. Three dose levels were evaluated in a dose escalation fashion. YS Group commenced the cancer patient enrollment for the Phase I clinical study in China in December 2021, focusing on the safety study on late-stage breast cancer, lung cancer, liver cancer and melanoma subjects. YS Group expects to complete Phase I clinical study in China in 2023.

### ***YS Group's Preclinical Stage Product Candidates***

#### *PIKA Recombinant COVID-19 Vaccine (prophylactic/nebulized)*

COVID-19 is a respiratory system disease. It is important to establish mucosal immune protection, which indicates that mucosal vaccination (such as intranasal, pulmonary and oral) may be better than injection vaccination. Mucosal immunity is the first battlefield of antiviral infection. The effective weapons of mucosal immunity are secretory IgA dimers, as well as T cells and B cells that are activated by antigens. Secretory IgA can provide additional protection in the respiratory mucosa (especially the upper respiratory tract) in addition to IgG, and neutralize SARS-CoV-2 virus earlier and more effectively. The resident memory B cells and T cells activated in the respiratory mucosa encounter antigens earlier than the systemic memory cells and react faster, which can hinder virus replication and reduce virus shedding and transmission.

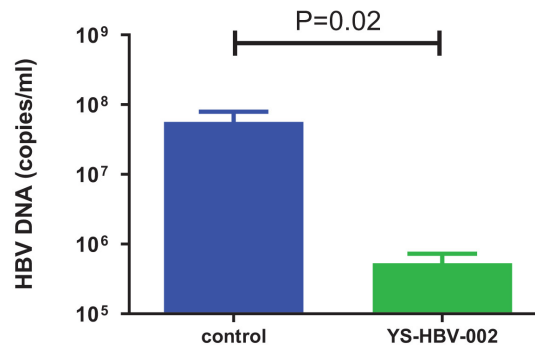
#### *PIKA Recombinant COVID-19 Vaccine (therapeutic)*

PIKA Recombinant COVID-19 Vaccine is also being developed as a therapeutic vaccine to treat SARS-CoV-2 infection. It has been granted by the regulatory authorities in UAE a Phase I clinical study license to enroll human subjects for the treatment of SARS-CoV-2 infection. There are two types of mechanistic hypothesis for the therapeutic function of PIKA COVID-19 Vaccine. First, the vaccine is capable of rapidly inducing the non-specific immune response which plays an important role in virus elimination. Second, it is related to its ability to promote antigen specific cellular immunity. When used in combination with antigen, PIKA adjuvant can promote the maturity of APC and the effective presentation of antigen, and then activate CTL to release perforin and granzyme, so as to produce cytolysis on virus infected cells, thus playing an antiviral role. In the study of cellular immunity of PIKA COVID-19 Vaccine, it was found that the enhancement of specific cellular immunity can be observed as early as 5 days after the initial immunization, indicating that the specific cellular immune response induced by the vaccine may play an important role in early virus clearance. The results of the SARS CoV-2 virus challenge protection test of hACE2 mice and cynomolgus showed that the virus load in the lung tissues could be significantly reduced by the administration of the vaccine, showing its potential effect as a treatment of SARS-CoV-2 infection.

#### *PIKA YS-HBV-002*

PIKA YS-HBV-002 is being developed as an immune-therapy vaccine to treat chronic HBV infection, a significant unmet medical need worldwide. YS-HBV-001 contains PIKA adjuvant and HBV surface antigen, whose primary indication is the prevention of HBV infection. In contrast, PIKA YS-HBV-002 contains PIKA adjuvant and multiple HBV antigens, whose primary indication is the treatment of patients with chronic hepatitis B. Leveraging YS Group's proprietary PIKA immunomodulating technology in developing PIKA YS-HBV-001, PIKA YS-HBV-002 seeks to control and eliminate HBV from infected patients, which cannot be achieved through currently available anti-viral drugs. It is now widely accepted that in order to cure HBV, immune-based intervention will play an essential role in addition to the current antiviral approaches. The importance of T cells in establishing a functional cure of chronic HBV infection is a well-established concept based on human and animal data. HBV-specific T cells are quantitatively and functionally defective in CHB patients. The role of natural killer cells is also reported to play protective role in the control of HBV replication. YS Group's PIKA immunomodulating technology has the potential to generate potent activators of both T and NK cells and a strong inducer of interferon production, which makes PIKA adjuvant suitable to be integrated into a therapeutic HBV vaccine. The following figure shows the preliminary anti-viral result of PIKA YS-HBV-002.

Figure 24. Decline in HBV DNA by HBV-002 in transgenic mice



Data are shown as mean  $\pm$  SEM. Significance was calculated using unpaired *t*-test.

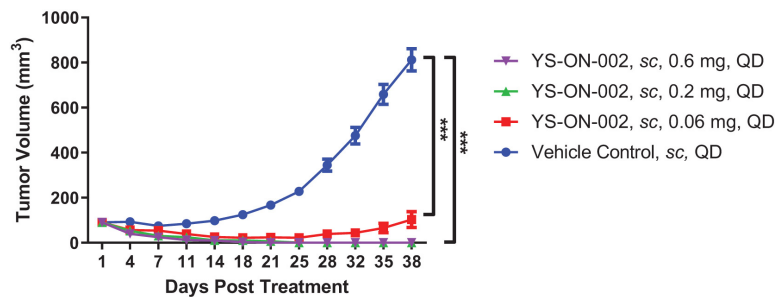
According to the CDE and F&S Report, the development of HBV therapeutic vaccine in China is at its nascent stage, and there was no marketed HBV therapeutic vaccine in China as of the date of this proxy statement/prospectus. There were six HBV therapeutic vaccine candidates in China as of July 31, 2022.

#### PIKA YS-ON-002

PIKA YS-ON-002 is being developed as another immune-oncology therapy based on YS Group's PIKA immunomodulating technology platform. Compared with PIKA YS-ON-001, which is a composition of PIKA agent with immunogenic protein-based antigens and other expedients, PIKA YS-ON-002 is a composition of PIKA agent, stabilization agent and other expedients. PIKA YS-ON-002 has a broad spectrum of anti-tumor activity against many tumor types, such as liver, colon, breast, lung, prostate, kidney, lymphoma and pancreatic cancer. YS Group believes that PIKA YS-ON-002 will have significant synergistic effect when combined with other treatment modalities such as chemotherapies, radiation therapies, checkpoint inhibitors and kinase inhibitors, leading to broad market opportunities.

PIKA YS-ON-002, when administered subcutaneously once a week, has demonstrated anti-tumor activities with a tumor growth inhibition of 76.42% against pancreatic cancer in a mouse model. When given at higher doses, PIKA YS-ON-002 completely eradicated established tumors, and some animals remained tumor free even after the cessation of PIKA YS-ON-002. The low dose of PIKA YS-ON-002 achieved 40% tumor free.

Figure 25. Anti-tumor effects of PIKA YS-ON-002 on subcutaneous Pan02 Murine Pancreatic Cancer Model



Data are shown as mean  $\pm$  SEM. *P*-values were analyzed with a two-way ANOVA (\*\*\*)  $p < 0.001$

#### PIKA Influenza Vaccine

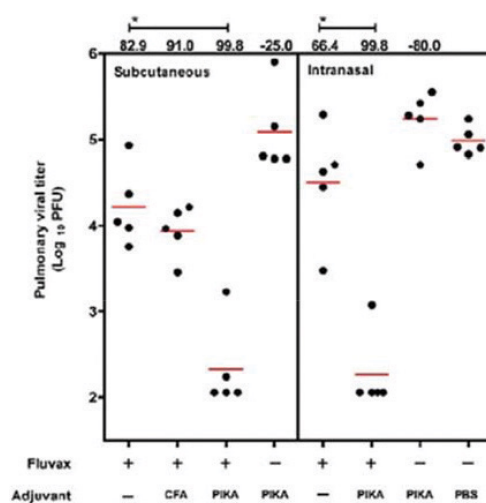
PIKA influenza vaccine is designed to contain quadrivalent seasonal inactivated influenza virus recommended by regulatory authorities regarding the annual seasonal vaccine. These inactivated influenza virus function as antigens which induce a humoral immune response, measured by hemagglutination inhibition (HI) antibody.

The addition of PIKA adjuvant may enhance the humoral and cellular immune responses. Specific levels of HI antibody titers induced by vaccination with recombinant HA protein vaccine have not been correlated with protection from influenza illness. In some human studies, HI antibody titers of 1:40 or greater have been associated with protection from influenza in up to 50% of subjects.

Antibodies against one influenza virus type or subtype confer limited or no protection against another. Furthermore, antibodies to one antigenic variant of influenza virus might not protect against a new antigenic variant of the same type or subtype. Frequent (usually annual) development of antigenic variants through antigenic drift is the virologic basis for seasonal epidemics and the reason for the usual replacement of one or more influenza virus strains in each year's influenza vaccine. Influenza vaccines are standardized to contain the hemagglutinins of influenza virus, representing the influenza viruses that are likely to be in circulation in the upcoming influenza season. Annual vaccination with the influenza vaccine is recommended because immunity during the year after vaccination declines, and circulating strains of influenza virus also change from year to year.

In a seasonal influenza mouse model, addition of PIKA was able to significantly enhance the antibody production via intranasal or subcutaneous administration of inactivated influenza vaccine, as compared to antigen alone. In an influenza virus challenge model, PIKA- adjuvanted influenza vaccine reduced the viral loads by 100-fold in the lungs, as compared to antigen alone. Antigen sparing effects by PIKA adjuvant were also demonstrated in a seasonal influenza mouse model that mixes PIKA with 0.015 ug of antigen dose which induced similar level of antibody responses to 1.5 ug antigen without adjuvant. In H5N1 pandemic influenza mouse model, PIKA-adjuvanted inactivated vaccine has demonstrated enhanced humoral immune responses and profound reduction of viral loads in the lungs. More importantly, using a lethal H7 influenza virus challenge model, mice vaccinated with inactivated H7N7 vaccine were completely protected against lethal challenge with H7N9 virus, which indicates clinical potential of the cross protection. In addition, with the potential of nasal application, PIKA influenza vaccines may have advantages compared to injectable-only vaccines such as better acceptance due to painless administration, additional protection by mucosal immunity and more user-friendly self-administration, especially during epidemics.

Figure 26. Pulmonary viral titer on day 5 post-infection in mice challenged with 50 PFU of PR8 intranasally three weeks after the boosting



• p<0.05

#### *PIKA Rabies Vaccine (Human diploid cell)*

PIKA Rabies Vaccine (Human diploid cell) is designed and positioned as a new generation of rabies vaccine based on the YS Group's PIKA immunomodulating technology platform. Compared with PIKA Rabies

Vaccine currently at clinical stage, containing PIKA agent and inactive rabies virus antigen derived from Vero cell line, the antigen component of PIKA Rabies Vaccine (Human diploid Cell) is generated from human diploid cell line.

By leveraging the PIKA technology, YS Group believes that, compared to the existing rabies vaccine using human diploid cell in the market, PIKA Rabies Vaccine (Human diploid cell) has the potential to provide quick onset of immune response, lower dosage form and longer duration of protection and better safety advantages. YS Group expects to move this program into IND application in 2024.

### **YS Group's Strategic Collaborations**

#### ***CEPI Clinical Research Collaboration***

YS Group and CEPI entered into a memorandum of agreement in June 2022 in relation to YS Group's collaboration with CEPI for the Phase II clinical study of PIKA recombinant COVID-19 vaccine of YS Group where CEPI is providing technical expertise and laboratory testing support to YS Group for such studies. CEPI is a world leading organization missioned is to promote and strengthen public-private collaboration in order to develop, manufacture and stockpile vaccines necessary to respond to emerging infectious diseases and to support vaccine research and development in connection with public health emergencies. According to the memorandum of agreement, the cooperation will last for three years. CEPI will provide YS Group with sample testing services, including testing 900 samples for wild type virus neutralization and 180 samples for variant omicron BA.1. CEPI will pay the laboratory for the sample testing services for preclinical, phase I, phase II(a) samples from YS Group while YS Group will pay the laboratory for the sample testing services for phase II(b) and phase III samples, in addition to the shipping costs and customs fees. The memorandum of agreement does not affect the ownership of any IP rights in either party's background IP. YS Group shall exclusively own all IP of the test results and shall have the right to use it for any purposes.

#### ***Global Health Agreement with Adjuvant***

YS Group entered into a global health agreement with Adjuvant Global Health Technology Fund, L.P. ("Adjuvant"), as amended, in connection with Adjuvant's investment of \$10.0 million in the redeemable convertible preferred stock financing. Adjuvant is an investment fund formed for the charitable purpose of improving global health through the provision of financing to address global health challenges by supporting the development, production and commercialization of drugs, vaccines, medical devices, preventatives, diagnostics and other related technology targeting neglected infectious diseases and other global health conditions impacting low- and middle-income countries as defined by the World Bank. Pursuant to the agreement, YS Group undertook, with the funding support in the amount of \$10.0 million from Adjuvant, to, among others, apply such funds to develop and commercialize YSJA™ rabies vaccine in 31 low income and 47 lower-middle income countries as defined by the World Bank (the "Designated Markets"). YS Group agreed to use commercially reasonable efforts to pursue WHO prequalification to make the vaccine eligible for purchase and delivery by United Nation agencies and make the vaccine available in sufficient volume to both public and private purchasers in the Designated Markets with a reasonable tiered pricing framework, determined with reference to the type of buyer and the geographical location of such buyer. Alternatively, YS Group could satisfy the foregoing obligations by licensing or partnering with a third party that has the capabilities to develop and commercialize YSJA™ rabies vaccine in the Designated Markets. The obligation has a term of seven years and will be terminated prior to such term when and if YS Group has licensed or partnered with a third party to discharge such obligations with the prior consent of Adjuvant. YS Group also agreed to furnish certain periodical reports, including the use of the funding and the progress of the commercial objectives. If YS Biopharma fails to maintain compliance with these and other program-related investment commitments under such global health agreement, Adjuvant may be entitled to repayment for any portion of its investment that is not used for the purposes outlined in such agreement, the maximum amount of which is limited to Adjuvant's aggregate investment of \$10.0 million. As of the date of this proxy statement/prospectus, Adjuvant's aggregate investment has been fully utilized toward development of product pipelines as well as develop and commercialize YSJA™ rabies vaccines overseas. In the event of the assignment, sale, exclusive license, or other transfer of intellectual property related to YSJA™ rabies vaccines and related technology, YS Biopharma must ensure that the aforementioned commitments are expressly assumed by the purchaser, transferee, licensee, or acquirer. Upon the occurrence of certain events, including the failure, by YS



Biopharma or any successor to prosecute related material intellectual property, to comply with the global health agreement, YS Biopharma agrees to grant Adjuvant a nonexclusive, irrevocable, non-terminable, fully-paid up, royalty free license (with the right to sublicense to third parties) to YSJA™ rabies vaccine to use, reproduce, modify, make, have made, distribute, sell and otherwise dispose of the product solely in the Designated Markets for the sole purpose of achieving its commitment under the global health agreement. The global health agreement has a term of seven years commencing from July 10, 2020, and may be terminated earlier if YS Biopharma, with the prior consent of Adjuvant, out-license to a third party with the capabilities to develop and commercialize YSJA™ rabies vaccine.

## Research and Development

YS Group believes that its commitment to researching and developing innovative products and technologies is fundamental to its success. YS Group takes pride in its PIKA immunomodulating technology, which has enabled a robust portfolio of product candidates. YS Group's R&D team focuses on the key functions of the R&D process; and YS Group's scientific advisory board provide critical guidance to its R&D efforts.

### *PIKA Immunomodulating Technology Platform*

#### *Overview*

YS Group's PIKA immunomodulating technology targets toll-like receptor-3 (TLR3), retinoic acid inducible gene-I (RIG-I), and melanoma differentiation-associated protein 5 (MDA 5), to activate the innate immune cells, such as antigen presenting cells and dendritic cells. The incorporation of YS Group's PIKA immunomodulating technology in its vaccines and therapeutic biologics has achieved substantially enhanced immune responses as observed in both clinical and preclinical studies.

Since YS Group acquired the PIKA immunomodulating technology in 2010, YS Group has pursued in-house advancement of the PIKA technology in multiple fronts, including the following:

- *More in-depth understanding of the mechanism of action underlying the technology.* YS Group identified the capability of PIKA immunomodulating technology for T-cell activation in human clinical study, as well as the change of tumor cell micro- environment in the immuno-oncology field. YS Group's findings in the immuno-oncology area established the anti-tumor mechanism of action in PIKA adjuvant, which laid a theoretical foundation for the application of PIKA adjuvant in tumor immunotherapy.
- *Developed clinical applications and expanded protection of IP.* YS Group has developed the application of PIKA adjuvant into multiple areas, including rabies vaccines, COVID-19 vaccines, prophylactic and therapeutic HBV vaccines and 33 immuno-oncology. YS Group obtained patents for such relating to both vaccine and anti-cancer fields in multiple jurisdictions.
- *Large-scale manufacturing technology of PIKA adjuvants.* YS Group has established an automated process of PIKA synthesis with the scale of over 100 liter in size under the relevant GMP guidance, which is critical to the commercialization of PIKA- based vaccine and therapeutic candidates.

YS Group believes that its PIKA immunomodulating technology has the potential to generate prophylactic and therapeutic vaccines. PIKA immunomodulating technology has already produced clinical stage candidates in four areas, including (1) PIKA rabies vaccine with significantly fast onset of seroconversion, ideally for three-visit one-week regimen to replace the existing five-visit one-month and three-visit three-week regimen, (2) emerging immuno-oncology therapeutic biologics, including PIKA YS-ON-001 and PIKA YS-ON-002 with broad anti-cancer properties, (3) HBV interventions, PIKA YS-HBV-001, a new preventive vaccine targeting two-visit one-month regimen to replace the existing three-visit six-month regimen, and PIKA YS-HBV-002, a therapeutic product to treat chronic HBV infection, and (4) PIKA YS-SC2-010, also known as PIKA recombinant COVID-19 vaccine, a prophylactic and therapeutic vaccine against COVID-19 disease caused by SARS-CoV-2. See the sections entitled “— YS Group's Marketed Product and Product Candidates — YS Group's clinical stage product candidates” and “— YS Group's Marketed Product and Product Candidates — YS Group's preclinical stage product candidates.”

YS Group has obtained patents relating to its PIKA immunomodulating technology in more than 30 countries and regions. See the sections entitled “— Intellectual Property — Patents.”

In the United States, the NIH has recognized the innovation and the potential of PIKA adjuvant in vaccine and other biologics fields and therefore has included PIKA adjuvant technology in the NIH vaccine adjuvant compendium, to promote scientific exchange and research collaboration around PIKA technology worldwide. The list includes scientific findings of PIKA adjuvant and data related to rabies virus, SARS-Cov-2 virus (recombinant protein), influenza A virus and hepatitis B virus.

#### *Mechanism of actions*

PIKA molecule is a class of double strand RNA (dsRNA) molecules of well-defined, specific ribonucleic acid units and molecular weight distribution synthesized with YS Group's proprietary technology. Endosomal dsRNA can be recognized by TLR3 while cytosolic dsRNA can be sensed by the retinoic acid-inducible gene (RIG) I-like receptor (RLR) family which include RIG-I and melanoma differentiation-associated protein 5 (MDA 5).

TLR3 is expressed primarily endosomal and in multiple cell and tissue types, including epithelial cells, muscle cells, certain neoplasms and antigen presenting cells; the RIG-I and MDA5 are ubiquitously expressed. Through TLR3, RIG-I and MDA5 signaling, PIKA can induce a prompt production of interferon, cytokines, chemokines and costimulatory factors. The anti-viral and anti-tumor effects of interferon have been well established and led to the U.S. FDA approval of several interferon-based products for antiviral and anti-tumor indications. In recent years, the U.S. FDA approved several TLR adjuvanted vaccines, including TLR4 based HPV vaccine (Cervarix) and zoster vaccine (Shingrix), and TLR9 based HBV vaccine (HEPLISAV-B). TLRs have also attracted substantial interests in cancer research with emerging body of evidence indicating that strong innate and adaptive immune response induced by TLR activation could play a critical role in the cancer treatment. TLR based cancer monotherapy or combination therapies are currently in different phases of clinical development.

Double-strand RNA stimulation can activate dendritic cells and upregulate the co-stimulatory and activation markers of dendritic cells such as CD86 and CD40. Dendritic cells play critical role in innate and adaptive anti-viral and anti-tumor immune responses.

Protein-based vaccine without proper adjuvant is poorly presented by dendritic cells to CD8 T cells which are essential for anti-viral and anti-tumor effect. The production of type I interferon upon PIKA stimulation facilitates antigen cross presentation by dendritic cells and augment CD8 T cell and NK cell responses, which makes protein-based vaccines suitable for viral clearance and as well as anti-tumor indications. DsRNA is also found to activate NK cells through TLR-TICAM-1 pathway, and decrease both regulatory T cells and myeloid-derived suppressor cells, which also provide rationale for integrating PIKA in anti-viral and anti-cancer treatment.

TLR3 is expressed by sentinel cells of the innate immune system such as dendritic cells, natural killer cells, and macrophages, and by nonimmune cells including epithelial cells, fibroblasts, and endothelial cells. TLR3 localizes to the endosomes where it senses viral and host-derived nucleic acids and initiates inflammatory pathways, activating the innate immune response and establishing an antiviral state to prevent viral replication. Its expression modulates rapidly in response to pathogens, various cytokines, and environmental stress.

TLR3 expression on immune cells has been widely exploited to promote an anti-tumor immune response, and various TLR3 agonists have been investigated in clinical trials for their anti-tumor immunity. The anti-tumor responses that are induced by TLR3 agonists are attributed to their capability to stimulate APCs, such as DCs, which in turn activate tumor specific T cell responses and to their capacity to switch the phenotype of myeloid suppressor cells and tumor associated macrophages from immunosuppressive to immunosupportive.

TLR3 signaling can also occur on nonimmune cells, contributing to an anti-tumor response. Many types of cancer express TLR3, including breast cancer, oral cell squamous and esophageal cancer, cervical cancer, ovarian cancer, prostate cancer, head and neck cancer, hepatocellular cancer and melanoma. Cancer cells respond to TLR3 ligands by secreting inflammatory cytokines, type I interferon, and chemokines, which enhance the recruitment and activation of immune cells.

Moreover, TLR3 agonists are found to promote the direct inhibition of tumor growth in vitro in several mouse and human cancer cell models through two mechanisms: decreasing proliferation and inducing apoptotic cell death.

**Scientific advisory board**

YS Group's scientific advisory board, established in 2011, plays an active role in the review of YS Group's biopharmaceutical product development programs. YS Group also seeks advice from its scientific advisory board on research and development strategy and technical matters.

**Yunde Hou, M.D., Ph. D.**, is an academician of the Chinese Academy of Engineering and is currently the Director of the Academician Laboratory of the National Institute of Viral Disease Control and Prevention under the national CDC in China, as well as the Chief Technological Officer of National Science and Technology Major Project for Viral Diseases. He was founder and former Chairman of the Chinese Society of Virology and was one of the two laureates for the 2017 China's National Preeminent Science and Technology Award, the highest scientific award in China. Dr. Hou is also the former Dean of the Institute of Virology, the Chinese Academy of Preventive Medicine, and former Vice President of the Chinese Academy of Engineering. Dr. Hou is the leader of recombinant interferon and many genetically engineered drugs. He was the first person in China that successfully isolated para-influenza viruses I, III and IV. He has developed preventive and therapeutic licensed biological products. Dr. Hou received a B.S. in medicine from Tongji University and a Ph.D. in medical sciences from the Iwanowski Virus Research Institute of the former Soviet Union.

**Mr. Yongxin Yu** is an academician of the Chinese Academy of Engineering and is currently the Chief Vaccine Expert of the National Institutes for Food and Drug Control. As a prominent leader in the field of vaccinology and virology in China. Mr. Yu has nearly 60 years of experience in the research and development of vaccines and has been widely recognized for his contributions to the quality control and research of vaccines for diseases such as Japanese encephalitis and rabies. From the 1950s to the 1980s, he led the development of the SA14-14-2 strain for the Japanese encephalitis live attenuated vaccine, which was the first live attenuated vaccine against Japanese encephalitis in the world and has fundamentally suppressed the viral spread in China since its mass adoption. He also chaired the strain selection and cultivation relating to primary hamster kidney cell rabies vaccine in China, which improved the safety and efficacy profile compared with previous rabies vaccine then available in China. Mr. Yu has authored or co-authored numerous articles and books and currently serves on the editorial boards of several peer-reviewed journals.

**Mann Fung, M.D.** is the chief executive officer of Tavotek Biotherapeutics, a biopharmaceutical company focused on medicines for cancers and autoimmune diseases. He was a former Vice President of Johnson & Johnson, where he led the development and strategies on innovative oncology therapies in the Asia-Pacific region. Prior to that, he served as Vice President for the research and development of innovative antitumor drugs and 36immune-oncology therapeutics at the U.S. headquarters of Johnson & Johnson, during which he was noted for leading the development of Ibrutinib, an internationally recognized potent inhibitor of Bruton's tyrosine kinase. Dr. Fung also served at several positions at Eli Lilly and Company, including as Head of Oncology and Critical Care Products for Lilly Japan. Dr. Fung is a fellow of American College of Physicians and also a scientific advisory board member of Virogin Biotech. Dr. Fung obtained his M.D. degrees from the University of Utah. He also obtained a Master in Health Care Management from Harvard University.

**Guang Gao, Ph.D.** is the senior technical officer at Shanghai Representative Office of PATH, an international non-profit organization to develop and deliver lifesaving vaccines to women, children, and communities around the globe. Dr. Gao has distinguished expertise in advising PATH partners in China and working with vaccine manufacturers in China to improve their quality system and manufacturing capability to bring their products to domestic and global markets. She has extensive experience in the fields of GMP manufacturing regulation, regulatory inspection, review and approval of vaccines and biological products in China and the United States. During her tenure at the FDA China office, she provided authoritative guidance and consultations regarding regulatory inspections and investigations and worked directly with the Chinese government for public health system evaluations. Prior to that, Dr. Gao served multiple positions at the Center for Biologics Evaluation and Research of the FDA, including as a national authoritative regulatory review scientist to provide technical leadership and guidance for regulatory activities. Dr. Gao has obtained the Regulatory Affairs Certification accredited by the Regulatory Affairs Certification Board and the Certified Quality Auditor Certification accredited by the American Society for Quality. Dr. Gao also published numerous papers on peer-reviewed scientific journals. Dr. Gao received her Ph.D. degree in biochemistry from Nanjing University.

## ***Research and development team and activities***

### *In-house research and development team and activities*

As YS Group engaged in both the manufacturing of YSJA™ rabies vaccine and the continuous exploration of its PIKA-based candidate pipeline, YS Group's research and development efforts span from those relating to its marketed product, in particular those relating to manufacturing technologies and quality assurance and control, to those relating to its product candidates, such as PIKA adjuvant and relevant products.

YS Group's R&D team consisted of about 206 employees or 23.82% of total employees in YS Group as of September 30, 2022. YS Group's R&D team is located in Beijing, Shenyang (China), Maryland (the United States) and Singapore, involved in different stages of the R&D process relating to YS Group's marketed product and product candidates such as preclinical studies, clinical trials, regulatory filings and process development. YS Group's core R&D staff also specialize in different aspects of YS Group's R&D initiatives, which consist of preclinical team, clinical team, regulatory filling team and intellectual property team. In addition, YS Group's quality management staff in Shenyang also supports YS Group's R&D by performing the related quality assurance and control activities.

YS Group's preclinical team is responsible for proof-of-concept, preclinical evaluation, establishment of manufacturing processes and formulation, quality research and method development. YS Group's preclinical team is further divided into different R&D focuses, such as project, platform and culture collection, PIKA adjuvant, bioreactor and technology development. YS Group's clinical team is primarily responsible for performing clinical trial study design and management, including the selection of clinical trial sites. YS Group's regulatory filing team is primarily responsible for vaccines and biologics approval process and monitoring YS Group's R&D projects to ensure their compliance with relevant regulations. YS Group's intellectual property team is primarily responsible for patent and trademark application and maintenance, and they thoroughly communicate with technicians to conduct intellectual property retrieval and analysis.

### *Outsourced research and development activities*

In line with industry practice, YS Group outsources certain testing activities related to research and development to independent CROs. See the section entitled “— Raw Materials and Suppliers — CROs” for details. YS Group cooperates with reputable organizations and institutions with respect to its outsourced research and development activities, which provide important access to human subjects and professional testing and clinical trial services. For instance, YS Group cooperates with certain active hospital units in Singapore, which are operated under stringent standards and high efficiency, providing on-site support to investigators as well as safety, security and reassurance for study volunteers. YS Group also cooperates with reputable institutions in China such as CDC, the Institute of Microbiology of the Chinese Academy of Sciences (IMCAS), the Kunming Institute of Zoology of the Chinese Academy of Sciences (KIZ) and the Institute of Laboratory Animal Science, Chinese Academy of Medical Sciences & Peking Union Medical College (CAMS&PUMC).

### ***Research facilities***

YS Group has established four research and development sites located in Maryland (the United States), Singapore, Beijing and Shenyang (China). YS Group strategically allocates its R&D activities in different regions according to their respective advantages and resources. For example, YS Group primarily carry out its late stage R&D activities relating to PIKA rabies vaccine in Shenyang facilities, leveraging its in-depth experience in pilot and large scale of manufacturing functions.

### **Intellectual Property**

YS Group's intellectual property and proprietary technology are important to its success. YS Group relies primarily on a combination of patent, trademark and trade secret protection laws as well as employee confidentiality agreements to safeguard and protect YS Group's intellectual property rights and knowledge as well as YS Group's brand. YS Group's ability to protect and use its intellectual property rights in the continued development and commercialization of YS Group's technologies and products, operate without infringing upon the proprietary rights of others, and prevent others from infringing YS Group's proprietary rights, is

also crucial to YS Group's continued success. YS Group will be able to protect its products and technologies from unauthorized use by third parties only to the extent that they are covered by valid and enforceable patents, trademarks or copyrights, or are effectively maintained as trade secrets, knowledge or other proprietary information. With respect to, among other things, proprietary knowledge that is not patentable and processes for which patents are difficult to enforce, YS Group relies on trade secret protection and confidentiality agreements (or confidentiality provisions in employment contracts) to safeguard YS Group's interests. YS Group believes that many elements of its products, clinical trial data and manufacturing processes involve proprietary knowledge, technology or data that are not covered by patents or patent applications. YS Group has taken appropriate security measures to protect these elements. In particular, YS Group has entered into confidentiality, non-compete and invention assignment agreements with its executive officers and research and development personnel. These agreements address intellectual property protection issues and require the employees to assign to YS Group all of the inventions, designs and technologies they develop during their terms of employment and cooperate with YS Group to secure patent protection for these inventions if YS Group wishes to pursue such protection. Any of these parties may breach the agreements and disclose YS Group's confidential information or YS Group's competitors might learn of the information in some other way. If any of YS Group's trade secrets, knowledge or other proprietary information that is not protected by a patent were to be disclosed to or independently developed by a competitor, YS Group's business, results of operations and financial condition could be materially and adversely affected. Despite any measures YS Group may take to protect its intellectual property, no assurance can be made that unauthorized parties will not attempt to copy aspects of YS Group's products or manufacturing processes or YS Group's proprietary technology, or to obtain and use information that YS Group regards as proprietary. See the section entitled "Risk Factors—Risks Related to YS Group's Intellectual Property."

### ***Patents***

YS Group actively seeks for its PIKA immunomodulating technology and product candidates embodying the technology, and consider on a case-by-case basis filing patent applications with a view to protecting certain innovative products, processes, and methods of treatment (or other equivalents in certain jurisdictions). As of the date of this proxy statement/prospectus, Singapore Yisheng is the proprietary owner of a vast majority of YS Group's patents owning about 70 patents in over 30 countries and the term of individual patents may vary based on the countries in which they are obtained. The patent portfolios for YS Group's PIKA immunomodulating technology and major clinical stage product candidates as of the date of this proxy statement/prospectus are summarized below.

Product/technology	Patent name	Owner/applicant	Jurisdiction	Patent status <sup>(1)</sup>	Patent expiration	Type of patent
PIKA adjuvant	Polyinosinic acid-polycytidylic acid-based adjuvant	Singapore Yisheng	Australia, Brazil, Canada, Cuba, the European Union, Austria, Belgium, Switzerland, Denmark, France, the United Kingdom, Ireland, Italy, Netherlands, Poland, Turkey, Spain, Sweden, Germany, Indonesia, Israel, India, South Korea, Malaysia, New Zealand, the Philippines, Russia, Singapore, Thailand, Taiwan (China), the United States, Vietnam, South Africa	Granted	2025 to 2027	Composition of matter
		Singapore Yisheng	the United States, Mexico	Granted	2025	
	Immunogenic substances comprising a polyinosinic acid-polycytidylic acid-based adjuvant	Singapore Yisheng	China, Australia, Hong Kong, Cuba, Indonesia, India, Mexico, Malaysia, New Zealand, the Philippines, Russia, Singapore, Taiwan (China), the United States, Vietnam, South Africa	Granted	2026 to 2028	Composition of matter
		Singapore Yisheng	Brazil, Thailand	Pending	N/A	
	Mucosal Immunogenic substances comprising a polyinosinic acid-polycytidylic acid-based adjuvant	Singapore Yisheng	Australia, Canada, Hong Kong, Cuba, Indonesia, South Korea, Malaysia, New Zealand, the Philippines, Singapore, South Africa	Granted	2026 to 2028	Composition of matter
		Beijing Yisheng	China	Granted	2026	
Singapore Yisheng		Taiwan (China)	Granted	2027		
PIKA rabies vaccine (Vero cell)	A rabies composition comprising PIKA adjuvant	Singapore Yisheng	China, Indonesia, Russia, South Africa	Granted	2034 to 2037	Composition of matter
		Singapore Yisheng	Brazil, India, the Philippines, Thailand, the United States, Vietnam	Pending	N/A	
	A composition comprising PIC for treatment of cancer	Singapore Yisheng	the United States, the European Union, Russia, South Africa	Granted	2037 to 2038	Composition of matter
PIKA YS-ON-001 (Cancer)	A composition comprising PIC for treatment of cancer	Singapore Yisheng	Australia, Brazil, Canada, Hong Kong, Cuba, Indonesia, India, South Korea, Mexico, Malaysia, New Zealand, the Philippines, Singapore, Thailand, the United States, Vietnam	Pending	N/A	
		Singapore Yisheng				

(1) Although YS Group has filed certain patent applications outside China, some of them are still at the unpublished stage. YS Group has uniformly named the legal status of patent applications outside China that have not been granted, whether published or not, as “pending.”

***Trademarks and domain names***

As of the date of this proxy statement/prospectus, YS Group owned 16 registered trademarks in China. YS Group has one registered domain name, liaoningyisheng.com.

As its brand name is becoming more recognized in the vaccine market, YS Group is working to maintain, increase and enforce its rights in this trademark portfolio, the protection of which is important to YS Group's reputation and branding.

In the two fiscal years ended March 31, 2022 and up to the date of this proxy statement/prospectus, YS Group was not involved in any material proceedings in respect of intellectual property right infringement claims against YS Group or initiated by YS Group. However, there are risks that YS Group may be subject to claims that YS Group has infringed the intellectual property rights of third parties, and YS Group may not be able to adequately protect its own intellectual property rights. For details, see the section entitled "Risk Factors — Risks Related to YS Group's Intellectual Property."

**Manufacturing*****Manufacturing facilities***

YS Group has been independently manufacturing its clinical stage biologics. As of the date of this proxy statement/prospectus, YS Group manufactured YSJA™ rabies vaccine in Shenyang, China through its own manufacturing facilities. YS Group has not contracted with third parties to manufacture its marketed product.

Manufacturing is subject to extensive regulations that impose various procedural and documentation requirements governing record keeping, manufacturing processes and controls, personnel, quality control and quality assurance, among others. YS Group's manufacturing facilities operate under GMP conditions, which are regulatory requirements for the production of pharmaceuticals that will be used in humans.

In November 2022, YS Group's manufacturing facilities for PIKA recombinant COVID-19 vaccine product successfully passed an audit by a European Union Qualified Person (QP). The audit was based on the guidance of European Union Good Manufacturing Practice ("EU GMP") and the guiding principles of the International Council for Harmonisation of Technical Requirements for Pharmaceuticals for Human Use (ICH). This EU QP audit involved a comprehensive and in-depth audit focused on the production quality of PIKA recombinant COVID-19 vaccine. The audit scope covered production system, facility and equipment management, quality control, quality assurance, material management and other systems. This indicates that the manufacturing site of YS Group complies with European pharmaceutical GMP standards and has the ability to provide high quality pharmaceutical product for clinical studies and commercialization in European and international markets.

YS Group's current manufacturing facilities, certified under China 2010 GMP standard, have an annual production capacity of approximately 15 million doses of YSJA™ rabies vaccine. In the two fiscal years ended March 31, 2022 and the six months ended September 30, 2022, YS Group had manufactured approximately 26 million doses of YSJA™ rabies vaccine. Since the GMP certified plant started production in February 2020, the utilization has increased gradually and reached approximately 58.33%, 81.25% and 91.67%, for the two fiscal years ended March 31, 2022 and September 30, 2022 respectively. The utilization rate is calculated by dividing the raw material input of a given three-month period by the corresponding production capacity during the same period.

YS Group has adopted a series of advanced measures and technologies for the current manufacturing facilities to improve YS Group's quality control. See the section entitled "— Quality Management" for details. YS Group has implemented new engineering specifications and equipment and machinery for its manufacturing processes. For example, YS Group developed in-house and implemented sterilization technology and devices in the heating, ventilation, air-conditioning and cooling systems used in its manufacturing procedures to ensure product quality and purity for human use. YS Group leveled up its manufacturing techniques to elevate the product standard of its vaccines, such as enhancing the method to remove residual DNA and protein impurities in vaccines. YS Group also installed the continuous mixing solution tank system and pipeline network to transport fluids throughout the plants, which reduces the chances of contamination and pollution. In addition, YS Group installed the circulating steam system to provide enduring, system-wide sterilization.

Furthermore, to avoid human error and contamination risk, YS Group installed a fully automated transportation vehicle system for sample handling and delivery in its filling and packaging workshop.

As of the date of this proxy statement/prospectus, YS Group has equipped its current manufacturing facilities with engineering specification to produce YSJA™ rabies vaccine, which is different from the engineering specification for PIKA-related products. If the demand for YSJA™ rabies vaccine were to decrease in the future, YS Group could modify its current manufacturing facilities accordingly and upgrade the engineering specification with bioreactor specification to produce PIKA-related products. Based on YS Group's manufacturing experience, YS Group believes that the relevant modification process is practicable and manageable and can be completed in a timely manner.

### ***Expansion plan***

YS Group owns the land use right to three adjacent parcels of land located in Shenyang Economy and Technology Development Zone, Shenyang, China with an aggregate site area of approximately 215,357 sq.m. To facilitate the R&D efforts and the potential product launches, YS Group plans to establish new manufacturing workshops in Singapore and China to meet additional commercial demand of new product launches in Southeast Asia. The following table sets forth certain details of YS Group's expansion plan.

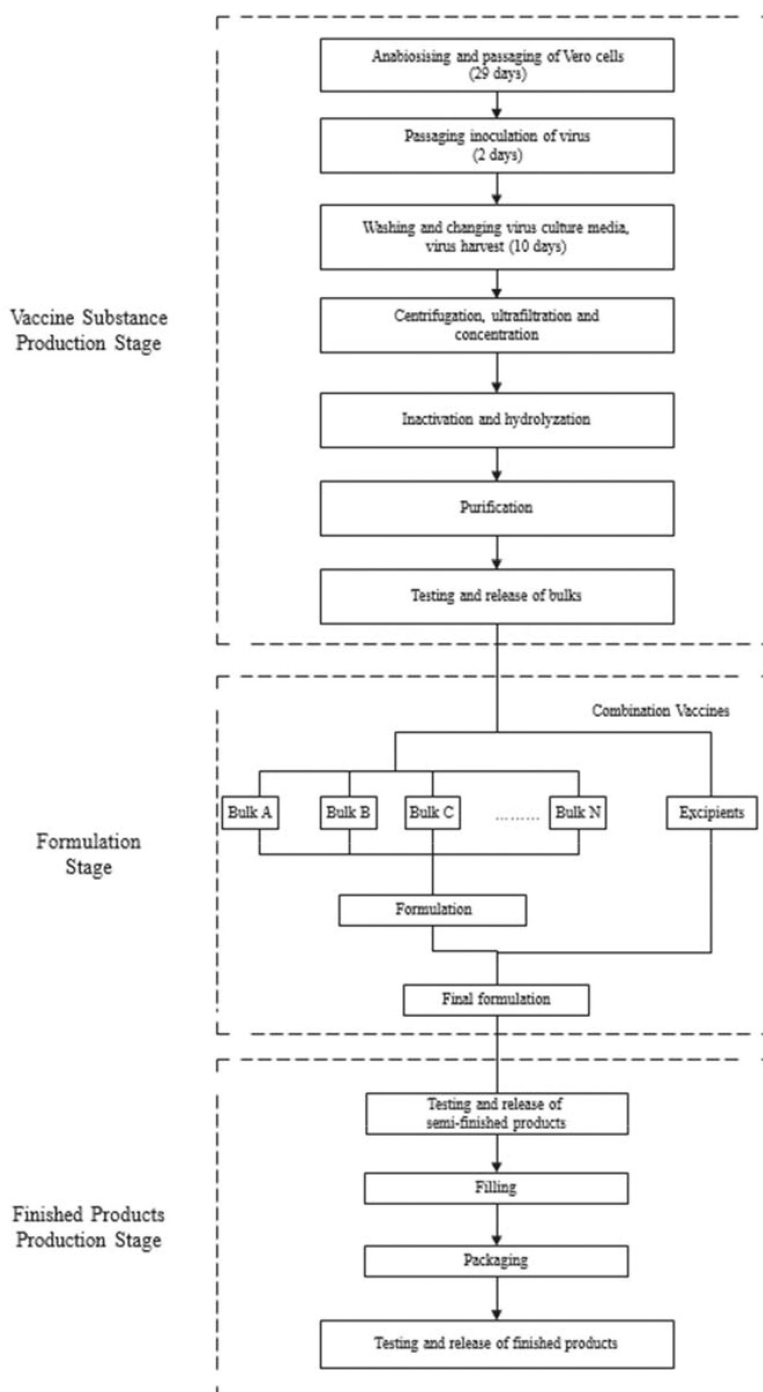
<b>Project</b>	<b>Construction area</b>	<b>Actual/expected construction commencement date</b>	<b>Expected construction completion date</b>	<b>Expected manufacturing capacity</b>
	(sq.m.)			(in total number of doses/year)
One manufacturing workshop for PIKA rabies vaccine in Singapore	14,577	October 2023	March 2025	To be determined
Two manufacturing workshops for PIKA recombinant COVID-19 vaccine in Shenyang (China)	6,831	March 2021	March 2023	500 million

YS Group may face a number of uncertainties in implementing its expansion plan, including its ability to obtain the requisite filings, permits, licenses and approvals for the construction and operation of the new facilities, the risk of construction delays and delays in equipment procurement, and its ability to timely recruit sufficient qualified staff. Furthermore, if YS Group fails to receive the NDA approvals of its product candidates or conduct product launches in a time manner, or at all, YS Group may have the additional manufacturing capacity underutilized, which could adversely impact YS Group's prospects, business and liquidity.



**Manufacturing Process**

The following diagram summarizes the major steps of the manufacturing process of YSJA™ rabies vaccine.



The following is a brief description of the key steps in YS Group's manufacturing process.

- *Anabiosising and passaging of Vero cells.* Vero cells used for production are taken out from the working cell bank and restored to normal state through temperature change to meet the needs of culturing. The anabiosised cells are cultured in specific bottles with culture media. After several generations, the cells can be used for subsequent virus infection.
- *Passaging and inoculation of virus, washing and changing virus culture media, virus harvest.* The virus will reproduce after being inoculated to the cultured Vero cells, and then be used in the later production process. The virus is also key ingredients of vaccine, which can be used as antigen to activate immune system to produce immune response.
- *Centrifugation, ultrafiltration and concentration.* The virus is separated from the debris of the host cells through the centrifugation process, and the harvested virus solution undergoes ultrafiltration to reach effective antigen concentration.
- *Inactivation and hydrolyzation of virus.* The nucleic acid structure of the virus is destroyed through the action of the inactivating agent 3-propiolactone, after which the virus loses its ability to infect. However, the protein structure is preserved and immunogenicity is retained. In addition, the inactivator is degraded to compounds through hydrolyzation so that it will not affect human body.
- *Purification.* Through gel chromatography antigen, pure virus antigen is obtained by removing impurities such as impure protein, host DNA, residual serum and antibiotics produced during the process of pre-production.
- *Formulation and preparation of semi-finished products.* The purified virus is mixed with stabilizers and excipients for subsequent filling.
- *Filling and lyophilization.* The semi-finished products are transported to the filling equipment through the pipeline system for automatic filling. After filling, the products are transferred to the freeze-drying machine through the automatic feeding and discharging system for freeze-drying, so as to change the products from liquid state to solid state.
- *Packaging.* The freeze-dried products were capped, lamp inspected and labeled, and then packaged in different specifications in terms of vials and boxes.

The production period of YSJA™ rabies vaccine is approximately five months, and the shelf life of YSJA™ rabies vaccine is approximately 36 months.

#### ***Manufacturing machinery and equipment***

YS Group's manufacturing facilities in Shenyang are equipped with machinery and equipment owned by it, including reactors, purifiers, automated media preparation station and lines, freeze-dryer, filling lines, probs and monitoring system, quality inspection and other equipment for different stages of YS Group's manufacturing process. YS Group has adopted three-, five- and ten-year depreciation method to its electronic equipment, transportation and mechanical equipment, respectively. As of the date of this proxy statement/prospectus, based on YS Group's regular inspection and maintenance of its equipment, its machines and equipment were in good working condition. YS Group did not experience any material or prolonged interruptions to its manufacturing process due to machinery or equipment failure in the two fiscal years ended March 31, 2022 and update to the date of this proxy statement/prospectus. YS Group updates its manufacturing machinery and equipment based on its evaluation of the effectiveness of its performance.

#### ***Inventory Management***

YS Group's inventory primarily consists of raw materials, packaging materials, testing reagents, instruments, finished goods, and consumables used for its vaccine development. YS Group procures raw materials and packing materials according to the estimated production time of its products, and as the case may be, generally maintain an inventory level of three to six months for raw materials to meet YS Group's vaccine production needs, and as the case may be, generally maintain an inventory level of one to two months for its packaging materials. For imported raw materials, YS Group as the case may be, generally maintains an inventory level of six to 12 months. YS Group maintains the inventory level of four to six months of finished products according

to the batch issuing cycle of biological products and the estimated customer demand. In particular, YS Group will closely monitor the vaccine bidding information of each province and the status of its applications to better plan its production and control its inventory level.

YS Group has established an inventory management system to monitor each stage of the warehousing process according to the GMP regulations. YS Group's inventory management system records inventory data, such as inventory balance and validity period, and keeps track of inventory levels, enabling YS Group to make adjustments whenever necessary. As part of GMP-compliant facilities, YS Group has a warehouse at its manufacturing facilities, including the inspection waiting areas and post inspection areas. Warehouse personnel are required to complete periodic training and are responsible for the inspection, storage and distribution of inventories. All inventory is separately stored in different areas of the warehouse according to the storage condition requirement, usage and batch number. In order to improve YS Group's logistics efficiency of its finished vaccine products, in addition to YS Group's centralized warehouse for finished vaccine products in its manufacturing site in Shenyang, YS Group has set up 30 satellite transition warehouses located at different regions across China as September 30, 2022.

### **Quality Management**

YS Group has established a comprehensive GMP-compliant quality management system to manage the day-to-day operations at its facilities, with a major emphasis on manufacturing management and finished vaccine product management. YS Group's quality management team is divided into quality assurance and quality control teams. YS Group's quality assurance team is responsible for establishing comprehensive quality policies, ensuring its compliance with global quality guidelines and maintaining all quality-related documentation, as well as validation function. YS Group's quality control team is responsible for quality testing, inspection and review for all its products and raw materials. In addition, YS Group has assembled a validation team for quality inspection and validation in respect of its machinery, facilities and manufacturing processes.

YS Group's comprehensive quality management system is supported by various stringent policies relating to vaccine research, development and manufacturing. For instance, YS Group has designed and implemented a series of technical and procedural guidelines relating to the manufacturing of YSJA™ rabies vaccine, such as cell and strain preparation, formulation and packaging. YS Group has also adopted multiple policies on the management of its laboratories, experiment data and samples. Moreover, YS Group's quality management system is designed to ensure compliance with the GMP, pharmacopoeia, labeling requirements and other applicable laws and regulations. Quality issues identified are documented, escalated to and reviewed by senior management. YS Group also conducts a formal risk assessment and justification process in accordance with the standards and procedures under its quality management system and policies.

YS Group has enhanced its manufacturing technologies and system with the procurement and upgrades of machinery and equipment, such as the sterile isolator, microplate reader, total organic carbon analyzer and chromatography equipment, and have validated their functionality and ability to generate accurate and effective data. YS Group has also established various protocols to analyze and evaluate the standard of its manufacturing and packaging processes.

YS Group has established reliable testing procedures for raw materials, work-in-progress products, and finished products, which include (1) multiple procedures for raw and auxiliary materials, such as Earle's balanced salt solution microbial limits test, sterility test for human albumin solution, and moisture determination test; (2) multiple procedures for work-in-progress products, such as virus titration of single-harvest virus fluids, protein content determination test, and stock solution sterility test for freeze-dried, Vero cell human rabies vaccines; and (3) multiple procedures for finished products, such as protein residue test for Vero cells, residue determination of gentamicin sulfate, and abnormal toxicity test.

From time to time, YS Group adjusts its internal protocols, such as those on manufacturing processes and procedures, testing methods, sterile approaches and operating guidelines, to ensure that they meet the requirement of the relevant laws and regulations in a timely manner. For instance, YS Group has conducted a comprehensive review of its internal protocols in response to the amended appendix of biological products of the Guidelines on Good Manufacturing Practices (the "2020 Amendments"), pursuant to which YS Group made specific amendments or supplementation to more than 200 internal policies. The amendments cover a

wide range of YS Group's manufacturing and R&D activities, including the testing methods of certain substances, the management and verification guidelines and quality standards relating to certain ingredients, work-in-progress products and culture media, and the operating guidelines involved in multiple quality examination procedures. In addition, YS Group reviewed the profiles and job responsibilities of the relevant quality management personnel to ensure they have the expertise and qualifications required under the 2020 Amendments. YS Group is also in the process of constructing its manufacturing execution system ("MES") and laboratory information management system ("LIMS") to promote real-time information collection and enhance the reliability of the data generated or used in its manufacturing and R&D process. The implementation of MES will allow YS Group to establish a reliable platform that digitizes the manufacturing process and integrates multiple management modules, including such for production data management and quality management. The implementation of LIMS, which comprises both computer hardware and software, will allow YS Group to systematically collect, analyze, report and manage their information in the laboratory. YS Group launched the construction of MES and LIMS in February and April 2021, respectively. YS Group has officially integrated MES into its manufacturing process for YSJA™ rabies vaccine and to officially adopt LIMS. The aggregate implementation fees for MES and LIMS incurred is approximately RMB7.4 million.

In terms of sterility testing, YS Group has adopted the soft-chamber isolators, which effectively guarantee the quality of the testing environment. YS Group requires all of its inspection staff to have relevant qualifications and receive systematic training on sterility inspection. They are also required to attend regular trainings on sterility inspection methods organized by the Liaoning Provincial Inspection, Testing and Certification Center and the National Institute for Food and Drug Control.

YS Group requires all employees to attend employment trainings as a prerequisite for employment. The trainings include subjects on the GMP standards, primary laws and regulations relating to vaccines and drugs in China, microbiology, biosafety, job responsibilities, operational protocols and managerial procedures. Employees must pass YS Group's assessments and obtain the requisite certificate before onboarding. Specifically, YS Group's key personnel are required to pass a practice-based test on the respective inspection procedures before they assume their responsibilities.

## **Sales and Marketing**

### ***Sales model***

YS Group operates primarily in the Category II vaccines market in China. Pursuant to the PRC laws and regulations, YS Group must win bids in the public tender process of the province-level CDCs, which give YS Group qualification to access the respective province-level markets. YS Group is then generally required to make direct sales to, and settle payment with, county-level CDCs, which may then distribute to healthcare providers. YS Group is independent from both province-level and county-level CDCs. In addition, YS Group is responsible for the quality control during transportation until the products are delivered to the county-level CDCs. The entire transportation of vaccines must be in a cold-chain, in which the temperature is usually required to range between 2°C and 8°C.

YS Group usually enters into sales agreements with county-level CDCs from time to time based on their purchase orders, instead of long-term agreements. Pursuant to the sales agreements, YS Group is required to deliver products to county-level CDCs, and they generally have seven days after delivery to dispute any quality issues. The purchase price is determined in the public tender process according to the provisions in the public tender agreements. YS Group typically requires payment by wire transfer and allow a credit period of three to four months, consistent with industry practice. YS Group typically does not allow return or exchange of vaccines sold or refund unless its products are defective or are substandard or are damaged during transportation.

As of September 30, 2022, YS Group had a dedicated in-house commercialization team of approximately 40 employees. YS Group's commercialization team mainly monitors its sales performance and seeks growth opportunities by ensuring its sales relationships with CDCs in their covered regions. They manage and supervise YS Group's service providers, conduct market research and analysis, and monitor information about product safety and quality. The remuneration of YS Group's commercialization team comprises base salary and performance-based bonuses, which are determined based on a comprehensive matrix of factors such as

the number, responsiveness, process management and planning, compliance status and information collection ability of the external service providers engaged by the commercialization team members.

In addition, YS Group expects to expand the commercial potential of YSJA™ rabies vaccine into certain Southeast Asian countries, such as Singapore, the Philippines, Vietnam and Malaysia. YS Group intends to seek potential partnership and licensing in those countries to facilitate its commercialization process. YS Group plans to assemble a sales force in collaboration with its local business partners, which will comprise both YS Group's internal sales management team and local salespersons with extensive resources and know-hows. YS Group also intends to accelerate its business growth overseas by obtaining additional valuable resources through strategic global collaborations and acquisitions. YS Group currently expects to manufacture its YSJA™ rabies vaccine through its Shenyang manufacturing facility in compliance with local laws and regulations, including local GMP requirements.

#### ***Marketing service providers***

In line with industry practice, YS Group engages external service providers to support its sales and marketing efforts among practitioners and execute its sales plan in expanded scale. The extensive network of service providers assists in collecting and providing clinical information of products, including the product quality, safety and adverse event data from the clinical sites, monitoring the shipment and inventory at customer warehouse, managing account payable and payment collection, conducting product training and education programs for practitioner, which greatly strengthens its product presence and loyalty in the market place. As of September 30, 2022, YS Group engaged over 120 service providers located at different regions to promote its products in China.

YS Group determines the service items required based on its business needs. YS Group then determines the price for each service item in light of market condition of similar services, and the frequencies and amount of services required in light of the demand of its products. YS Group recognizes service fee expenses based on the actual amount of services incurred. The service fees are determined through arm's length business negotiations and based on the fair market price.

#### ***Public tender***

YS Group is required to participate in the public tender process held by province-level CDCs in China and win the bid in order to make sales into the relevant provinces. In the public tender, bidders are typically required to provide their qualifications, proposed pricing, comparison with actual price in other regions, proposed major business terms, after-sale service plan, their financial credentials and introduction of products. A successful bid typically leads to a one or two year qualification to sell products within the relevant provinces. During such qualified period, vaccines must be sold at the bid price accepted during the tender in the relevant region. County-level CDCs can purchase vaccines from any of the successful bidders.

#### ***Pricing***

YS Group determines the prices of its marketed product based on a number of factors, including competitive market position, market demands, cost of productions, product quality, affordability, price quotation of competing products in the bidding process, and the specific requirements from province-level CDCs as part of the bidding process. YS Group will also price the product candidates after obtaining NDA approvals in the future, the market price of which will be influenced by a number of factors, such as its costs of production, price quotations of competing products in the bidding process, its technological advantages, product quality and market trends, as well as changes in the levels of supply and demand. In addition, certain province-level CDCs may provide administrative guidance on pricing issues to relevant county-level CDCs under their administrative power, and such guidance may be determined on a stand-alone province level and/or on a case-by-case basis.

#### ***Transportation and storage***

YS Group implements cold-chain transportation and storage in the entire delivery process to the county-level CDCs to ensure real time monitoring and control of temperature, and as well as tracking system to keep records of the temperature of vaccines during transportation and storage. As a result, YS Group has adopted

cold chain logistics for product delivery primarily by engaging logistic companies with professional capabilities to make transportation of pharmaceuticals to deliver products via ground transportation, during which the temperature of the storage space of YS Group's products must be controlled and maintained in accordance with the relevant requirements. In addition, YS Group also engaged 30 satellite transition warehouses located at different regions across China as September 30, 2022, through which YS Group delivered its vaccines to county-level CDCs.

### Customers

YS Group started the sales of YSJA™ rabies vaccine and began to recognize the related revenues from October 2020, pursuant to which YS Group's customers are county-level CDCs. As required by government regulations and in line with industry practice, YS Group participates in the public tender process of the province-level CDCs, and if YS Group is successful in its bidding, the relevant province-level CDC will generally provide a public notice, pursuant to which YS Group enters into sales agreements and settle payments directly with county-level CDCs, which then distribute to healthcare providers. See the section entitled "— Sales and Marketing — Sales Model."

### Raw Materials and Suppliers

The principal raw materials required for the production of YS Group's biologics involves animal-based cells, plasma albumin, calf serum and Medium 199 powder. YS Group obtains materials largely from suppliers in China, and maintain at least two suppliers for all but one of the raw materials it uses. YS Group has historically not experienced any shortages in the raw materials YS Group uses, and the prices have generally remained stable. However, a risk exists that an interruption in supplies would materially harm YS Group's business. YS Group typically orders raw materials and services on a purchase order basis and do not enter into long-term dedicated capacity or minimum supply arrangements. YS Group typically maintains inventory of raw materials sufficient for three months of production. In addition, YS Group performs periodical reviews of its suppliers and facilities in accordance with GMP requirements.

Purchase from YS Group's top five suppliers accounted for 59.6% and 44.7% of its total purchases in the fiscal years ended March 31, 2021 and 2022, respectively, and purchase from YS Group's largest supplier accounted for 37.9% and 20.9% of its total purchases in the same periods, respectively.

### CROs

Consistent with industry practice, YS Group has engaged certain independent CROs to conduct (1) preclinical efficacy tests, safety evaluation, compatibility studies on packing materials, and tests such as antigen component or structure tests and other chemical and biological tests; and (2) certain clinical trial design and implementation services. YS Group selected CROs based on various factors, including their reputation, research experience, quality and equipment and machinery in the vaccine and pharmaceutical fields. In particular, YS Group has engaged CROs in the research and development of PIKA rabies vaccine, PIKA Recombinant COVID-19 vaccine, YS-HBV-002 and YS-ON-002.

Generally, YS Group entered into separate agreements with CROs for each preclinical and services and executed statements of work for each preclinical or clinical trial services. Key terms of such service agreements with CROs are summarized as follows:

- *Services.* With respect to preclinical studies, the CROs mainly provide services, including but not limited to: (1) efficacy and safety evaluation, such as acute toxicity test in mice and long-term toxicity test in animals; (2) compatibility studies on YS Group's products and their packaging; (3) tests such as antigen component quality or structure tests and other chemical and biological tests. With respect to clinical trials, the CROs provide clinical monitoring and inspection services, clinical research coordinator services, data management services, medical monitoring services, and biological samples management to YS Group.
- *Term.* The term of agreements for preclinical studies mainly range from one to three years. The term of agreements for clinical trials generally expires after the completion of clinical trials. The CROs are generally required to complete the relevant preclinical and clinical services within the prescribed time limit.

- *Payments.* YS Group is required to make payments to the CROs according to milestones of services and payment terms as defined in the relevant service agreements. Payments are either on lump-sum basis or in installments according to milestones of the respective services.
- *Confidentiality.* The CROs shall not disclose or disseminate any confidential information without YS Group's consent, such as material, data and information provided by YS Group for the contracted services.
- *Dispute resolution.* In the event of any disputes related to the enforcement of any agreement, the parties shall negotiate amicably. If an agreement cannot be reached, the parties have the right to sue.
- *Intellectual property rights.* Substantially all intellectual property rights arising from the preclinical studies and clinical trials conducted by CROs will be owned by YS Group. In certain cases and as prescribed under the relevant agreements, such as when YS Group develops new technological results with the technological service results provided by certain CROs during the contractual term, the intellectual property rights may belong to both parties.

### Competition

YS Group's industry is highly competitive and subject to rapid and significant change. While YS Group believes that its management's research, development and commercialization experience provide YS Group with competitive advantages, YS Group faces competition from biopharmaceutical companies (including specialty pharmaceutical companies), generic drug companies, biologics drug companies, academic institutions, government agencies and research institutions.

For YSJA™ rabies vaccine which is currently marketed in China, YS Group primarily faces competition from China-based pharmaceutical companies. For YS Group's product candidates, YS Group expects to face competition from a broad range of global and local pharmaceutical companies. Many of YS Group's competitors have significantly greater financial, technical and human resources than YS Group has, and mergers and acquisitions in the biopharmaceutical industry may result in even more resources being concentrated among a smaller number of YS Group's competitors. YS Group's commercial opportunity could be reduced or eliminated if YS Group's competitors develop or market products or other novel immunological biologics or vaccines that are more effective, safer or less costly than its current or future product candidates, or obtain regulatory approval for its products more rapidly than YS Group may obtain approval for its product candidates.

### Licenses, Permits and Approvals

As of the date of this proxy statement/prospectus, YS Group has obtained all requisite license, permission or approvals for its current business operations in China and none of such license, permission or approvals current in effect have been withdrawn or revoked by the competent governmental authorities.

The following table sets out a list of material licenses, permits, and approvals currently held by YS Group.

<u>Product</u>	<u>License/Permit</u>	<u>License/Permit Holder</u>	<u>Authority</u>	<u>Validity Period</u>
YSJA™ rabies vaccine	Drug Re-registration Certificate	Liaoning Yisheng	Medical Products Administration of Liaoning Province	2020.07.13 – 2025.07.12
YSJA™ rabies vaccine/ PIKA Recombinant COVID19 vaccine	Drug Manufacturing License	Liaoning Yisheng	Medical Products Administration of Liaoning Province	2022.06.15 – 2024.08.14

## Employees

Function	As of September 30, 2022	
	Number of Employees	% of Total
Research and development	206	23.82
General and administrative	172	19.88
Manufacturing	436	50.40
Sales, marketing and patient services	51	5.90
<b>Total</b>	<b>865</b>	<b>100</b>

As of September 30, 2022, YS Group had 865 full-time employees. The following table sets forth the number of YS Group's full-time employees by function as of September 30, 2022.

As required under labor laws in different jurisdictions, YS Group enters into individual employment contracts with its employees covering matters such as wages, bonuses, employee benefits, workplace safety, confidentiality obligations, non-competition and grounds for termination. In compliance with PRC regulations, YS Group participates in various employee social security plans that are organized by applicable governments, including housing, pension, medical insurance, work-related injury and unemployment benefit plans. YS Group is required under PRC laws to make contributions to employee benefit plans at specified percentages of the salaries.

YS Group's success depends on its ability to attract, retain and motivate qualified personnel. As part of its retention strategy, YS Group offers employees competitive salaries, performance-based cash bonuses, share-based compensation and other incentives. In order to maintain a competitive edge, YS Group will continue to focus on attracting and retaining qualified professionals by providing an incentive-based and market-driven compensation structure that rewards performance and results. In addition to on-the-job training, YS Group regularly provides management, technology, regulatory and other training to its employees through internally developed training programs or professional consultants.

YS Group believes that YS Group maintains a good working relationship with its employees and YS Group had not experienced any material labor disputes or any difficulty in recruiting staff for its operations in the two fiscal years ended March 31, 2022 and up to the date of this proxy statement/prospectus.

## Properties

### *Owned properties*

As of September 30, 2022, YS Group owned and operated one business facility in Shenyang, China primarily for manufacturing purposes. YS Group has built two manufacturing workshops for YSJA<sup>TM</sup> rabies vaccine, which are located in the Shenyang Economy and Technology Development Zone, Shenyang, China. YS Group has purchased the land use right to this area, which consists of land use rights to three pieces of land adjacent to each other, including (1) a right of land use for 44,655 sq.m, which will expire in January 2060, (2) a right of land use for 73,724 sq.m, which will expire in January 2060, and (3) a right of land use for 96,978 sq.m, which will expire in December 2056.

### *Leased properties*

As of September 30, 2022, YS Group operated its business through four leased properties in Beijing, United States and Singapore. Such properties primarily serves as offices. The expiration dates of two leased properties in Beijing, the leased properties in United and Singapore are November 2022, September 2025, November and March 2025, respectively. YS Group plans to renew its leases or negotiate new terms when the existing leases expire.

As of September 30, 2022, YS Group's leased property in Beijing with a total gross floor area of approximately 5,047 sq.m. was subject to a mortgage that had been placed before YS Group entered into the relevant lease



agreement. YS Group faced the associated risks that YS Group may not be able to continue to use the leased property upon foreclosure.

### **Insurance**

YS Group has maintained liability insurance in China and Singapore in compliance with relevant local regulations to cover liability claims that may arise from incidents relating to the clinical trials of its product candidates. YS Group maintains compulsory liability insurance for YSJA<sup>TM</sup> rabies vaccine in China. YS Group's existing insurance coverage may not be sufficient to cover any claim for product liability or damage to its fixed assets. YS Group does not maintain any business interruption insurance.

### **Legal Proceedings and Compliance**

YS Group is subject to legal proceedings, investigations and claims arising in the ordinary course of its business from time to time, including, among others, actions with respect to product liability and labor disputes. In the two fiscal years ended March 31, 2022 and up to the date of this proxy statement/prospectus, YS Group was not involved in any litigation or arbitration proceedings pending that could have a material and adverse effect on its business, financial condition or results of operations.

### **Environmental Protection, Occupational Health and Safety, and Social Responsibility**

YS Group is subject to environmental protection and occupational health and safety laws and regulations in China. As of the date of this proxy statement/prospectus, YS Group did not have any incidents or complaints which had a material and adverse effect on its business, financial condition or results of operations during the same period. YS Group strives to operate its manufacturing facilities in a manner that protects the environment and the health and safety of its employees and communities. YS Group has implemented company-wide environmental, health and safety ("EHS") policies and operating procedures relating to waste treatment, process safety management, workplace health and safety requirements, and emergency planning and response. For instance, for the waste treatment, YS Group has incorporated the waste management and minimization requirement to establish the characterization and management of wastes or by-products which are either disposed or recycled. For the process safety management, YS Group has established minimum requirements related to machine safety, trial process safety and personal protection. YS Group also has designated responsible personnel to ensure employees' awareness and compliance with the EHS policy. With respect to its manufacturing process and facilities, YS Group has implemented a series of measures to reduce the potential pollution and waste associated with its manufacturing activities. For instance, the biologically active waste liquid discharged in YS Group's production process is subject to a high-temperature inactivation process, through which it reaches the relevant discharge standard. In addition, YS Group engages qualified service providers to dispose solid waste generated in its manufacturing process in accordance with the medical waste regulations. YS Group also continuously upgrades its manufacturing techniques and raw materials and consumables to minimize the negative impact of its manufacturing activities on the environment.

YS Group has entered into employment contracts with its employees in accordance with the applicable PRC laws and regulations. YS Group hires employees based on their merits, and it is YS Group's corporate policy to offer equal opportunities to its employees regardless of gender, age, race, religion or any other social or personal characteristics. YS Group also strives to provide a safe working environment for its employees. YS Group has implemented work safety guidelines setting out safety practices, accident prevention and accident reporting. In particular, YS Group has established and implemented guidelines in accordance with relevant PRC laws and regulations on the storage, management, handling and use of viruses and bacteria. These guidelines include those related to the recording and inspection of lots of viruses and bacteria, a multi-department approval process to obtain viruses and bacteria from YS Group's inventory, as well as the safe disposal of viruses and bacteria. YS Group's employees with specified responsibilities, including handling certain equipment and conducting animal research, are required to hold relevant qualifications, as well as wearing proper safety gear when working. YS Group conducts safety inspections of its manufacturing facilities regularly.

## Regulations

### *Laws and Regulations in China*

#### *Laws and Regulations Relating to Drugs*

##### Major regulatory authorities

YS Group conduct its business in PRC and it is now principally subject to the supervision of the National Medical Products Administration and its local counterparts. The National Medical Products Administration was established in accordance with the Institutional Reform Program of the State Council promulgated by the National People's Congress (the "NPC") in March 2018, and the predecessor of the National Medical Products Administration is the China Food and Drug Administration (the "CFDA," together with the National Medical Products Administration, hereinafter collectively, the "NMPA"). The NMPA is the primary regulatory agency for pharmaceutical products and businesses and regulates almost all of the key stages of the life-cycle of pharmaceutical products, including nonclinical studies, clinical trials, marketing approvals, manufacturing, advertising and promotion, distribution, and pharmacovigilance (i.e., post-marketing safety reporting obligations), and it is under the supervision of State Administration for Market Regulation (the "SAMR"), a newly established institution for supervising and administrating the market in China.

The Center for Drug Evaluation (the "CDE"), which is a subsidiary under the NMPA, conducts the technical evaluation on each drug and biologic application to assess the safety and efficacy of each candidate. The National Health Commission of the PRC, formerly known by the names the Ministry of Health and National Health and Family Planning Commission (hereinafter collectively, the "NHC"), is China's primary healthcare regulatory agency. It is responsible for overseeing the operation of medical institutions, some of which also serve as clinical trial sites. NHC also plays a significant role in drug reimbursement.

The National Institutes for Food and Drug Control is a public institution directly subordinate to CFDA and the statutory authority and supreme technical arbitration institution for inspecting the quality of pharmaceuticals and biological products. It is responsible for the approval and registration inspection, import inspection, supervision and inspection, safety evaluation of drugs, biological products, medical devices, foods, dietary supplements, cosmetics, laboratory animals and package materials and the lot release of biological products, the research, distribution and management of the national drug and medical device reference materials and bacterial and viral strains for production verification, as well as the relevant technical research.

Chinese Center for Disease Control and Prevention is a public welfare institution established by the government to implement the national-level disease control and prevention and the public health technology management and services. Its main responsibility is to enhance the research on the disease control and prevention strategies and measures, participate in the vaccine research, carry out vaccine application result evaluation and immunity planning strategy research, and provide technical guidance and assessment on the implementation of the national immunity strategy under the leadership of NHC and the key tasks in national disease control and prevention.

##### Reform of medical and healthcare system

Pursuant to the Opinions of the State Council on Deepening the Reform of the Medical and Healthcare System issued on March 17, 2009, the reform of the medical and healthcare system has been orderly conducted. The medical insurance system has been gradually improved and the basic medical mechanism has been consolidated and improved.

On October 25, 2016, the State Council introduced the Plan for Healthy China 2030, which proposes to (1) improve the system for collaborative innovation involving different aspects of policy, industry, education, research and practice, and promoting medical innovation, transformation and upgrading, (2) research to establish an examination and approval system based on clinical effects, and raise the examination and approval standards for drugs (medical devices), and (3) accelerate the review and approval of innovative drugs (medical devices) and new drugs (medical devices) that are urgently needed in clinical practice.

According to the Notice of the Key Tasks of Deepening the Reform of Medical and Healthcare System in the second half of 2020, issued by the General Office of the State Council in July 2020, the government shall

improve the public health emergency supplies guarantee system and increase investment in research and development of vaccines, drugs, and rapid testing technologies. Besides, the government shall gradually establish and improve the drug information traceability mechanism, and realize the “one product, one code” of the drugs which are applied to centralized procurement and use by national organizations and vaccines.

#### Drug research and development

Pursuant to the Drug Administration Law of the PRC (the “Drug Administration Law”), last amended on August 26, 2019 and became effective on December 1, 2019, the State encourages the research and development of new drugs, and protects the legal rights and interests of citizens, legal persons and other organizations in the research and development of new drugs. The dossier on a new drug research and development, including the manufacturing method, quality standards, results of pharmacological and toxicological tests and the related data, documents and the samples, shall, in accordance with the regulations of NMPA be truthfully submitted to the competent authority for approval before the clinical trial is conducted. The NMPA shall, within 60 business days from the date on which the application for such clinical trial is accepted, decide on whether to approve it and then notify the clinical trial applicant. In the case of failure to notify the applicant within the prescribed time limit, it shall be deemed as approved. When a new drug has gone through the clinical trial and passed the evaluation, a drug registration certificate shall be issued upon approval by NMPA.

According to the Provisions for Drug Registration (the “Drug Registration Provisions”) which was lastly revised on January 22, 2020 and became effective on July 1, 2020, clinical trial of drugs shall be subject to approval, and bioequivalence test shall be filed; clinical trial of drugs shall comply with the Good Clinical Practice of Pharmaceutical Products (the “Good Clinical Practice”) and shall be carried out by drug clinical trial organizations which comply with the relevant provisions. Clinical trial of drugs shall consist of phases I, II, III and IV clinical trial as well as bioequivalence test. Based on the characteristics of drugs and research objective, the research contents shall include clinical pharmacology research, exploratory clinical trial, confirmatory clinical trial and post-marketing clinical research. On September 6, 2013, the Announcement of the NMPA on Drug Clinical Trial Information Platform providing that, instead of the aforementioned registration filed with the NMPA, all clinical trials approved by the NMPA and conducted in the PRC shall complete clinical trial registration and publish trial information through the Drug Clinical Trial Information Platform.

The Announcement on Adjusting Evaluation and Approval Procedures for Clinical Trials for Drugs was promulgated by the NMPA on July 24, 2018, according to which, if the applicant does not receive any negative or questioning opinions from the CDE within 60 days after the application is accepted and the fees are paid, the applicant can carry out the clinical trials in accordance with the submitted trial protocol.

The institutions for non-clinical safety evaluation and study and clinical trial organizations shall respectively implement the Good Laboratory Practice for Non-Clinical Laboratory Studies which became effective on September 1, 2017, and Good Clinical Practice for Clinical Laboratory Studies which was effective on September 1, 2003 and lastly revised on April 23, 2020 and became effective on July 1, 2020. If certain actions in the preclinical trial research and clinical research conducted for a clinical application trial, and/or in the application procedures for registration of medicines, are in violation of the relevant rules and regulations, the NMPA is authorized to handle such cases pursuant to the Measures regarding Non-compliance with Relevant Rules of Research and Application for Registration of Medicines promulgated on and effective from September 1, 1999.

#### Regulations on human genetic resources

The Interim Administrative Measures on Human Genetic Resources, promulgated by the Ministry of Science and Technology and the NHC in June 1998, aimed at protecting and fair utilizing human genetic resources in the PRC. The Ministry of Science and Technology promulgated the Service Guide for Administrative Licensing Items concerning Examination and Approval of Sampling, Collecting, Trading or Exporting Human Genetic Resources, or Taking Such Resources out of the PRC in July 2015, according to which, the sampling, collection or research activities of human genetic resources by a foreign-invested sponsor fall within the scope of international cooperation, and the cooperating organization of China shall apply for approval of the China Human Genetic Resources Management Office through the online system. The Ministry of Science and Technology further promulgated the Circular on Optimizing the Administrative Examination and

Approval of Human Genetic Resources in October 2017, which became effective in December 2017 and simplified the approval of sampling and collecting human genetic resources for the purpose of listing a drug in the PRC.

The Regulation on the Management of Human Genetic Resources, as promulgated by the State Council on May 28, 2019 and effective on July 1, 2019, further regulates the collection, preservation, usage and provision of human genetic resources. According to this regulation, “human genetic resource” includes human genetic resource materials and information. Human genetic resource materials refer to organs, tissues, cells and other genetic materials containing human genome, genes and other genetic materials. Human genetic resource information refers to information, such as data, generated by human genetic resources materials. The Administrative Department of Science and Technology under the State Council is responsible for the management of human genetic resources at the national level, and the administrative departments of science and technology under the provincial governments are responsible for the management of human genetic resources at local level and are vertically directed by the central government of the PRC. Foreign organizations, individuals and institutions established or actually controlled by foreign organizations and individuals are not allowed to collect or preserve human genetic resources (including organs, tissues, cells and other genetic materials of the human genome and genes) in China or provide human genetic resources abroad.

#### Laws and regulations on drug registration

According to the currently effective Drug Registration Provisions, if all the regulatory requirements are satisfied, the NMPA will grant a new drug certificate and a drug approval number, assuming the applicant has a valid Drug Manufacturing License and the requisite production conditions for the new medicine have been met. All pharmaceutical products that are produced in China must bear drug approval numbers issued by the NMPA, with the exception of certain Chinese herbs and Chinese herbal medicines in soluble form. Drug manufacturing enterprises must obtain the drug approval numbers before manufacturing any drug. A drug approval number issued by the NMPA is valid for five years and the applicant shall apply for renewal six months prior to its expiration date. Application for drug registration includes application for new drugs, application for generic drugs, application for imported drugs, application for supplementary drugs and its re-registration application. A new drug application refers to an application for registration of a drug that has not yet been marketed for sale in China. In addition, the registration of drugs that change the dosage form of the marketed drugs, change the route of administration, and increase the new indications shall be reported in accordance with the application procedures for new drugs. The NMPA then determines whether to approve the application according to the comprehensive evaluation opinion provided by the CDE. According to the Drug Registration Provisions, drug registration is regulated according to Chinese medicine, chemical medicine and biological products. As compared to the current effective version, the Drug Registration Provisions provides detailed procedural and substantive requirements for the key regulatory concepts established by the Drug Administration Law, confirms a number of reform actions that have been taken in the past years, including (1) the full implementation of Marketing Authorization Holder System and implied approval of the commencement of clinical trial; (2) implementing associated review of drugs, excipients and packaging materials; and (3) introducing four procedures for expedited registration of drugs, which are procedures for ground-breaking therapeutic drugs, procedures for conditional approval, procedures for prioritized reviews and approval, and procedures for special examination and approval.

On December 21, 2017, the Opinions on Encouraging the Prioritized Evaluation and Approval for Drug Innovations was promulgated by the NMPA and further replaced by the Announcement on the Release of Three Documents including the Procedures for the Evaluation of Breakthrough Therapeutic Drugs (Trial) issued by the NMPA on July 7, 2020, the three documents are namely the Procedures for the Evaluation of Breakthrough Therapeutic Drugs (Trial), Procedures for the Evaluation and Approval of the Listing Application for Conditional Approval of Drugs (Trial) and Procedures for Prioritized Evaluation and Approval for Drug Marketing (Trial), among others, which allow the applicant to apply for the breakthrough therapy drug procedure during the phase I and II clinical trials and normally no later than the commencement of phase III clinical trials for the innovative or improved drugs etc. which are used for the prevention and treatment of diseases that seriously endanger life or seriously affect quality of life and there is no effective means of prevention and treatment or there is sufficient evidence to show a significant clinical advantage over the existing treatments. In addition, when applying for the marketing license of a drug, for the drugs with obvious clinical value, the applicant can apply for the prior evaluation and approval procedure.

According to the Special Examination and Approval of Registration of New Drugs (the “Special Examination and Approval Provisions”) which was promulgated and implemented on January 7, 2009 by the NMPA, the NMPA conducts special examination and approval for new drug registration applications when (1) the effective constituent of drug extracted from plants, animals, minerals, etc. as well as the preparations thereof have never been marketed in China, and the material medicines and the preparations thereof are newly discovered; (2) the chemical raw material medicines as well as the preparations thereof and the biological product have not been approved for marketing in China and abroad; (3) the new drugs are for treating the Acquired Immune Deficiency Syndrome, malignant tumors and orphan diseases, etc., and have obvious advantages in clinic treatment; or (4) the new drugs are for treating diseases with no effective methods of treatment. The Special Examination and Approval Provisions further provide that the applicant may file for special examination and approval at the clinical trial application stage if the drug candidate falls within items (1) or (2), and if the drug candidates fall within items (3) or (4), the application for special examination and approval cannot be made until filing for production.

#### *Laws and regulations on drug manufacturing*

Pursuant to the Drug Administration Law and the Implementing Regulations of the Drug Administration Law of the PRC (the “Drug Administration Implementing Regulations”), a drug manufacturing enterprise is required to obtain a Drug Manufacturing License from the relevant provincial drug administration authority of the PRC. The grant of such permit is subject to an inspection of the manufacturing facilities, and an inspection to determine whether the sanitary condition, quality assurance systems, management structure and equipment meet the required standards. Pursuant to the Drug Administration Implementing Regulations and the Measures on the Supervision and Administration of the Manufacture of Drugs amended on November 17, 2017 and January 22, 2020 and became effective on July 1, 2020 (the “Drug Manufacture Supervision Measures”), the drug manufacturing license is valid for five years and the drug manufacturing enterprises shall apply to the original authority that issued such license for renewal six months prior to its expiration date. Where the marketing authorization holder consents to the production of pharmaceutical preparations, the marketing authorization holder shall apply to the provincial department of the NMPA for a Drug Manufacturing License and subject it to the inspection and other administrative supervision by government agencies.

The Guidelines on Good Manufacturing Practices (the “Guidelines”) which were amended in 1998 and 2010, set the basic standards for the manufacture of pharmaceuticals. The 2010 amendments to the Guidelines were promulgated by the Ministry of Health (now known as the NHC) on January 17, 2011 and came into effect on March 1, 2011. The Guidelines comprise a set of detailed standard guidelines governing the manufacture of drugs, including quality management, organization and personnel, plant and facilities, equipment, materials and products, confirmation and verification, production management, quality control and quality assurance, commissioned production and commissioned inspection, product shipping and recall, and self-inspection. Besides, the major differences between the 2010 revised edition and the 1998 revised edition of the Guidelines include the following: (1) the 2010 revised edition has more emphasis on the aseptic condition and purification during the production process; for example, the exposed processing areas of some non-sterile products shall be designed according to requirements for sterile products; (2) the 2010 revised edition enhances requirements for the production equipment and facilities, which involve not only the design and layout of the production area, storage area, quality control area and auxiliary area, but also the design, installation, maintenance, use, cleaning, status marking and calibration of the equipment and facilities; (3) the 2010 revised edition enhances the standard of management for drug manufacturing enterprises, including but not limited to (i) enhancing the qualification requirements for key personnel, which should at least include the heads of the manufacturer, production management, quality management, and the qualified person; and (ii) requiring manufacturers to establish a quality assurance system with the support of a complete documentation system to ensure its effective operation; and (4) the 2010 revised edition requires proactive or retrospective adoption of quality risk management, which means a systematic process for the assessment, control, communication and review of quality risks, throughout the entire product life cycle.

The NMPA issued the amended appendix of biological products to the Guidelines on Good Manufacturing Practices (the “2020 Amendments”) in April 2020, which came into effect on July 1, 2020, except for the requirement on information system which will come into effect in July 2022. The 2020 Amendments contain a total of 63 articles in eight chapters, with six new added articles and 15 revised articles. The major changes

under the 2020 Amendments include the following: (1) the 2020 Amendments require the manufacturers of biological products to establish and improve the biological safety management system in accordance with the laws and regulations related to biological safety management; (2) the 2020 Amendments further enhance the requirements for relevant practitioners, which include the requirements that (i) the training and examination of key personnel shall be strengthened and (ii) the authorized personnel designated to oversee and administer quality control shall hold a bachelor's degree or above in pharmacy, medicine or other related specialties, and shall have more than five years' experience in production quality management in related fields; (3) the 2020 Amendments add some detailed provisions concerning the production management and quality management, such as the requirements that (i) the suitability of culture media shall be examined, (ii) the acceptance criteria for chromatographic separation columns and methods for cleaning or sterilizing them shall be specified, and (iii) the adjuvants used for vaccines production shall be consistent with the relevant manufacturing process and quality standards approved by or filed with the drug administration authority; and (4) the 2020 Amendments also mandate that vaccine manufacturers shall truthfully record in electronic means all the data formed in the process of production and inspection to ensure that the whole production process is continuously compliant with the statutory requirements.

According to the Drug Administration Law, the requirement of obtaining a Good Manufacturing Practice Certificate is cancelled and the pharmaceutical manufacturing company shall comply with Good Manufacturing Practice for Drugs, establish and improve upon a drug manufacturing quality management system, ensure the whole drug manufacturing process continuously comply with statutory requirements.

#### Administration of affairs concerning laboratory animals

Pursuant to Regulations for Administration of Affairs Concerning Laboratory Animals approved by the State Council on October 31, 1988 and revised for the third time on March 1, 2017, the Administrative Measures on Good Practice of Laboratory Animals promulgated and implemented on December 11, 1997, and the Administrative Measures on the Certificate for Laboratory Animals (Trial) promulgated and implemented on January 1, 2002, performing experimentation on animals requires a License for Use of Laboratory Animals.

#### Pharmaceutical directions and labels of pharmaceutical products

According to the Measures for the Administration of the Pharmaceutical Directions and Labels of Drugs effective on June 1, 2006, the pharmaceutical directions and labels of drugs should be reviewed and approved by the NMPA. A pharmaceutical direction should include the important scientific data concerning drug safety and efficacy in order to direct the safe and rational use of drugs. The inner label of a drug should bear such information as the drug's common name, indication or function, strength, dose and usage, production date, batch number, expiry date and drug manufacturer, and the outer label of a drug should indicate such information as the drug's name, ingredients, character, specifications, description of the drug's indications and contraindications, precautions, dosage, date of production, product batch number, valid term, approval number, manufacturing enterprise and any adverse reactions.

#### Advertisements of drugs

On April 29, 2021, the Standing Committee of the National People's Congress (the "SCNPC") revised the Advertising Law of the PRC, according to which certain contents shall not be included in advertisement of drugs, such as an assertion or guarantee on the efficacy or the safety, stating a cure rate or effective rate.

#### Pharmaceutical product export

According to the Approval by NMPA on Certain Issues of Pharmaceutical Products Export, promulgated and effective on September 20, 1999, whether the enterprise can obtain the right to operate import and export business and the qualification shall be approved by relevant foreign trade authority. The pharmaceutical products export shall mainly comply with the requirements of the importing country, so long as there is no special requirement by the importation country, the pharmaceutical supervisory and administrative departments support the export in principal based on the national policy of encouraging exports. However, under the Drug Administration Law, the export licenses issued by the relevant NMPA are required for the export of narcotics and psychotropic substances falling within the restricted scope prescribed by the State.

On November 9, 2018, the NMPA promulgated Regulations on the Administration of Certificates of Export Sales of Pharmaceuticals, according to which, where a drug manufacturer applies for a Drug Export Sales Certificate, it shall submit an application form for a drug export sales certificate to the local drug regulatory department at the provincial level. The term of validity of the Drug Export Sales Certificate shall not exceed 2 years, and shall not exceed the term of validity of all the certificates in the application materials, and a new application shall be made before the expiry of the period of validity.

#### Drug recalls

According to the Measures on Drug Recall effective from December 10, 2007, a drug manufacturer should establish and improve its recall system by collecting relevant information about drug safety and making an investigation and evaluation with respect to the drugs with potential safety hazards. If there are any potential safety hazards that endanger human health and life safety in respect of any drugs sold in PRC, such manufacturer must start the drug recall procedures. Where a drug is recalled, the drug operating units and users should assist such manufacturer to satisfy its recall obligations by communicating the drug recall information and any feedback, controlling and recovering such drugs according to the recall plan.

#### Laws and regulations relating to vaccines

According to the Vaccine Administration Law of the PRC (the “VAL”), which was promulgated by the SCNPC on June 29, 2019 and came into effect on December 1, 2019, vaccines are divided into two categories based on whether it is under national immunization programs or not. For vaccines under national immunization programs, the competent health department of the State Council shall, in conjunction with the public finance department of the State Council, among others, organize centralized bidding or unified negotiation, and form and release bid price or transaction price, and vaccines shall be uniformly purchased by all provinces, autonomous regions and municipalities directly under the Central Government. Vaccines under other immunization programs other than vaccines under national immunization programs and vaccines not covered by immunization programs shall be purchased as organized by all provinces, autonomous regions and municipalities directly under the Central Government through provincial public resource trading platforms.

#### Vaccine administration

On January 15, 2017, the General Office of State Council issued Opinions on Further Enhancing Administration of Circulation and Vaccination of Vaccines, among others, to improve the work mechanism for the management of vaccines and promote the independent R&D and quality improvement of vaccines. The VAL requires the most stringent management system for vaccines, and at the same time, supports the basic research and applied research on vaccines, promotes the development and innovation of vaccines, including the development, production and reserve of vaccines for the prevention and control of serious diseases in the national strategy. Entities and individuals engaged in vaccine development, production, circulation and vaccination shall abide by the laws, regulations, rules, standards and specifications, ensure that the information during the whole process is true, accurate, complete and traceable, assume responsibilities in accordance with the law and accept social supervision.

Vaccine marketing authorization holders shall establish an electronic vaccine traceability system, which is connected with the national electronic vaccine traceability collaboration platform to realize the traceability and verifiability of the smallest packaging units of vaccines in the whole process of production, circulation and vaccination.

#### Development and registration of vaccines

On October 14, 2005, the NMPA promulgated the Notice on Issuing Six Technical Guidelines including the Technical Guidelines on Preclinical Study of Preventive Vaccines, which specified the requirements on preclinical research, change of production process, quality control in clinical stages of vaccine to ensure its safety and efficacy.

According to the VAL, clinical trials of vaccines shall be conducted or organized for implementation by Grade III medical institutions that meet the conditions prescribed by the drug administrative department

under the State Council and the competent health department under the State Council, or by disease prevention and control institutions at or above the provincial level.

A vaccine to be marketed within the territory of China shall be approved by the drug administrative department under the State Council and obtain a drug registration certificate; when applying for registration of a vaccine, an applicant shall provide true, sufficient and reliable data, information and samples. With respect to the vaccines urgently needed for disease prevention and control as well as the innovative vaccines, the drug administrative department under the State Council shall prioritize their evaluation and approval.

#### Production and lot release of vaccines

Whoever engages in vaccine production activities shall, in addition to meeting the conditions for engaging in drug production activities as prescribed in the Drug Administration Law, also meet the following conditions: (1) having moderate scale and sufficient capacity reserves; (2) having systems, facilities and equipment for ensuring bio-safety; and (3) meeting the needs of disease prevention and control. A vaccine marketing authorization holder shall have the capacity for production of vaccines. If it is really necessary to entrust the production of vaccines in excess of its capacity, the vaccine marketing authorization holder shall obtain the approval of the drug administrative department under the State Council. Where it accepts the entrustment to produce vaccines, it shall abide by the provisions of this Law and the relevant provisions of the State, so as to guarantee the quality of vaccines.

The State adopts a lot release system for vaccines. Each batch of vaccines shall, before being sold or imported, be examined and inspected according to the relevant technical requirements by the lot release institution designated by the drug administrative department under the State Council. If the requirements are met, a lot release certificate shall be issued; otherwise, a notice on rejecting lot release shall be issued. According to the Measures for Administration of Lot Release of Biological Products (the “Lot Release Administration Measures”) issued on December 13, 2002 and amended on February 1, 2018, the vaccine products with marketing approval shall be subject to document review, onsite verification and sample inspection by the designated drug control institution and pass the biological product lot release approval before the marketing and sales of each batch of products. On December 11, 2020, the SAMR amended the Measures for Administration of Lot Release of Biological Products, which came into effect on March 1, 2021 and does not make material changes on the substance of aforementioned provisions.

On July 8, 2022, the NMPA promulgated the Administrative Provisions on the Manufacture and Circulation of Vaccines, according to which, the marketing authorization holder shall assume the primary responsibilities for the safety, effectiveness and quality controllability of vaccines, carry out the management activities of post-marketing manufacture, circulation and other links of vaccines in accordance with laws and regulations and assume the corresponding responsibilities. An access system is implemented for the manufacture of vaccines and strictly controls the establishment of new vaccine manufacturers. A newly established vaccine manufacturer shall, in addition to meeting the conditions for the establishment of a vaccine manufacturer, conform to the relevant policies of the competent authority of the national vaccine industry. When applying for entrusted manufacture of vaccines, the entrusting party and the entrusted party shall, in accordance with the requirements of the relevant technical guiding principles, carry out research, evaluation and necessary verification, and the entrusting party shall, after completing the alteration of the corresponding production scope of the Drug Manufacturing License, file an application with the Center for Administrative Services and Complaints & Reports of the NMPA.

#### Circulation of vaccines

Based on the Drug Administration Law and the Law of the PRC on the Prevention and Treatment of Infectious Diseases, the State Council formulated and issued the Regulation on the Administration of Circulation and Vaccination of Vaccines on March 24, 2005 and revised this regulation on April 23, 2016. According to the Regulation on the Administration of Circulation and Vaccination of Vaccines, there are two types of vaccines. Category I vaccines refer to the vaccines provided by the government to citizens free of charge. Category II vaccines refer to other vaccines with which the citizens are voluntarily inoculated at their own expenses. Vaccine manufacturers shall supply Category I vaccines only to the provincial disease prevention and control institutions or other county-level designated disease prevention and control institutions according to the government purchase contract. The Category II vaccines shall be subject to collective purchase



organized by provincial disease prevention and control institutions on the provincial public resource trading platform, and purchased by the disease prevention and control institutions and then distributed to local vaccination units. Besides, the vaccine manufacturers shall abide by the rules on the administration of vaccine storage and transport, and guarantee the quality of vaccines. Vaccines shall be stored and transported in the environment with the prescribed temperature during the entire process, shall not be isolated from the cold chain, and the temperature shall be monitored and recorded at regular time.

On June 29, 2019, the SCNPC promulgated the VAL, which involves, among others, the research and development, registration, production, lot release, circulation, vaccination, monitoring and handling of abnormal reactions of the vaccines, as well as the management after the marketing of vaccines.

On March 27, 2020, the Decision of the State Council to Amend and Repeal Certain Administrative Regulations (2020) (the "Decision") was issued and came into effect on the same day. According to the Decision, certain articles of seven administrative regulations were revised and ten administrative regulations, including the Administration of Circulation and Vaccination of Vaccines, were repealed. The repeal of the Administration of Circulation and Vaccination of Vaccines did not have a significant impact on YS Group production and business activities. Prior to the Decision, the VAL had in effect replaced the Administration of Circulation and Vaccination of Vaccines, since it covers certain key provisions, including the circulation and vaccination of vaccines, monitoring and handling of abnormal reactions, and relevant supporting measures.

According to the Opinions on Further Enhancing Vaccine Circulation and Vaccination Administration issued by the General Office of State Council on January 15, 2017, both the public vaccines and private vaccine should be procured online on the provincial public resource trading platform in accordance with the principles of transparency, competition, and fair trade.

According to the VAL, the competent health department under the State Council shall, in concert with the finance department under the State Council and other departments, organize centralized bidding or unified negotiation to form and publish the bid-winning price or transaction price of vaccines under the National Immunization Program, and all provinces, autonomous regions and municipalities directly under the Central Government shall implement centralized procurement. The procurement of vaccines under other immunization program and vaccines not under the immunization program other than those under the National Immunization Program shall be organized by provinces, autonomous regions and municipalities directly under the Central Government through provincial public resources trading platforms.

The price of vaccines shall be set reasonably and independently by the vaccine marketing authorization holder according to law. The price level, price difference rate and profit rate of vaccines shall be kept within a reasonable range.

A vaccine marketing authorization holder shall, as agreed upon in the procurement contract, supply vaccines to the disease prevention and control institution. The disease prevention and control institutions shall supply vaccines to inoculation entities in accordance with the relevant provisions. Entities or individuals other than the disease prevention and control institutions shall not supply vaccines to inoculation entities, and inoculation entities shall not accept such vaccines. A vaccine marketing authorization holder shall, as agreed upon in the procurement contract, deliver vaccines to the disease prevention and control institution or the inoculation entity designated thereby. The vaccine marketing authorization holder and disease prevention and control institution that distribute vaccines themselves shall have the conditions for cold chain storage and transport of vaccines or may entrust eligible vaccine distribution entities to distribute vaccines. Vaccine marketing authorization holders shall establish an electronic vaccine traceability system, which is connected to the national electronic vaccine traceability collaboration platform to realize the traceability and verifiability of the smallest packaging units of vaccines in the whole process of production, circulation and vaccination. The disease prevention and control institutions shall truthfully record the information on vaccine circulation and vaccination in accordance with the relevant provisions, and shall provide the traceability information to the national electronic vaccine traceability collaboration platform in accordance with the relevant provisions.

A vaccine marketing authorization holder shall, when selling vaccines, provide a copy of the certificate of lot release or an electronic document affixed with its seal. If it sells imported vaccines, it shall also provide a copy of the imported drug clearance form or an electronic document affixed with its seal. A disease prevention and control institution or an inoculation entity shall, when receiving or purchasing vaccines, ask for the

abovementioned supporting documents, and preserve them for inspection for at least five years after expiry of validity of the vaccines. A vaccine marketing authorization holder shall, in accordance with the provisions, set up true, accurate and complete sales records, and preserve them for inspection for at least five years after expiry of the validity of the vaccines.

According to the VAL, whoever engages in vaccine production activities shall, in addition to meeting the conditions for engaging in drug production activities as prescribed in the Drug Administration Law, meet the following conditions: (1) having moderate scale and sufficient capacity reserves; (2) having systems, facilities and equipment for ensuring bio-safety; and (3) meeting the needs of disease prevention and control. According to the Government Procurement Law of PRC, vaccine suppliers shall meet the following requirements as a supplier in government procurement: (1) having the capacity to assume civil liabilities independently; (2) having a good business reputation and sound financial and accounting systems; (3) having the equipment and professional expertise needed for performing contracts; (4) having a clean record of paying taxes and making financial contributions to social security funds in accordance with law; (5) having committed no major breaches of law in its business operation in the three years prior to its participation in the procurement; and (6) other requirements provided for in laws and administrative regulations. Other specific requirements may differ slightly from province to province, but generally speaking, vaccine suppliers should possess qualifications required for vaccine manufacturers, including but not limited to the Drug Manufacturing License, the GMP Certificate and the drug registration approval.

#### Price Control of Vaccines

Pursuant to the VAL, vaccine price shall be determined by the vaccine marketing license holder in a legal, independent and rational manner. The price level, spread rate and profit rate of the vaccine shall be maintained at a reasonable level. The inoculation entity shall not charge any fees for the inoculation of vaccines under immunization programs. The inoculation entity that inoculates the vaccine not covered by immunization programs may, in addition to charging the vaccine fee, charge the vaccination service fee. The standards for charging vaccination service fees shall be determined by the competent price department of the people's government of the province, autonomous region or municipality directly under the Central Government in conjunction with the public finance department.

According to the Administrative Provisions on the Manufacture and Circulation of Vaccines, disease prevention and control institution, vaccination entity and the relevant parties of the entrusted storage and transportation enterprise shall, in accordance with the requirements of the national whole-process electronic traceability system for vaccines, faithfully record the information on the sale, storage, transportation and use of vaccines to realize the whole-process traceability of unit packages from production to use. The vaccine distributor shall, as required by the marketing authorization holder, truthfully and completely record the information on storage and transport.

#### Adverse Events

Pursuant to the VAL, if a lot release agency discovers any major quality risk of a vaccine during the lot release process, it shall promptly report to the drug supervision and administration department of the State Council and the drug supervision and administration departments of the People's Governments of different provinces, autonomous regions or municipalities directly under central government. The departments receiving the report should immediately conduct an on-site inspection of the marketing authorization holder of the vaccine and notify the lot release agency to not approve or suspend the lot release of the marketing authorization holder's related or all products based on the inspection results and order the rectification of the marketing authorization holder. In addition, for suspected abnormal reactions to vaccination, the disease prevention and control institutions shall report in a timely manner in accordance with related regulations, organize investigations and diagnoses, and inform the recipients or their guardians of the results of the investigations and diagnoses. If there is a dispute over the results of the investigation or diagnosis, an application for verification can be made in accordance with the verification method formulated by the health authorities under the State Council. In accordance with their respective responsibilities, the health authorities and drug supervision and administration departments of the People's Governments at or above the districted city level should organize the investigations and handling of any vaccination that causes death or severe disability of the recipient or any suspected abnormal group reactions to vaccination that have a major impact on the society.

Pursuant to the Lot Release Administration Measures, in any of the following situations, the lot release agencies should report to the drug supervision and administration departments of the provinces, autonomous regions or municipalities directly under central government where the lot release applicants and the production sites locate, suggest on-site inspections, and copy to the NMPA: (1) the sterility test is not qualified; (2) the effectiveness indexes such as efficacy are not qualified in two consecutive lots of inspection; (3) the material review indicates potential serious issues in quality control of the manufacturing, or the deviation in manufacturing techniques, quality difference, or failures and accidents in manufacturing need to be further investigated; (4) the application materials or samples for lot release may have authenticity problems; and (5) other situations that indicate major quality risks of the product. During the investigation and handling of the above-mentioned problems, the approval process or issuance of the corresponding varieties of the lot release applicant may be temporarily suspended. The drug supervision and administration departments of the provinces, autonomous regions, or municipalities directly under central government should conduct an on-site inspection within 10 days after receiving the notifications and recommendations from the lot release agencies. The drug supervision and administration departments of the provinces, autonomous regions, or municipalities directly under central government should provide a technical evaluation and a clear conclusion regarding the quality risks of to the lots of relevant products mentioned by the lot release agencies within 10 days after the inspection. Under extreme circumstances, the departments can appropriately extend the periods mentioned above with reasons provided.

#### Animal epidemic prevention

The Law of the People's Republic of China on Animal Epidemic Prevention (the "Revised Animal Epidemic Prevention Law") issued by the Standing Committee of the NPC on July 3, 1997 and recently amended on January 22, 2021, took effect on May 1, 2021. According to the Revised Animal Epidemic Prevention Law, animal epidemics are classified into three categories based on their harm to the breeding industry and human health. Rabies falls under the Category II as it may do serious harm to human and animals and cause major financial losses and social impact. When an animal epidemic of Category II breaks out, the following control measures shall be taken: (1) the administrative department for agriculture and rural area under the local people's government at or above the county level shall demarcate the epidemic locations, epidemic areas and vulnerable areas; and (2) the local people's government at or above the county level shall, where necessary, organize the relevant departments and entities to take measures such as isolation, killing, destruction, disinfection, bio-safety treatment, emergency vaccination and restriction on the movement and circulation of the susceptible animals, animal products and related goods. Furthermore, under the Revised Animal Epidemic Prevention Law, the entities and individuals that raise dogs shall have them administered with veterinary rabies vaccines regularly as required by relevant laws and regulations, and register at the local dog registration authority with an immunization certificate issued by an animal clinic.

#### *Regulations relating to data privacy and anti-bribery*

##### Data privacy

Pursuant to the Notice of the Supreme People's Court, the Supreme People's Procuratorate and the MPS on Legally Punishing Criminal Activities Infringing upon the Personal Information of Citizens which was issued in 2013, and the Interpretation of the Supreme People's Court and the Supreme People's Procuratorate on Several Issues regarding Legal Application in Criminal Cases Infringing upon the Personal Information of Citizens which was issued on May 8, 2017 and took effect on June 1, 2017, the following activities may constitute the crime of infringing upon a citizen's personal information: (1) providing a citizen's personal information to specified persons or releasing a citizen's personal information online or through other methods in violation of relevant national provisions; (2) providing legitimately collected information relating to a citizen to others without such citizen's consent (unless the information is processed, not traceable to a specific person and not recoverable); (3) collecting a citizen's personal information in violation of applicable rules and regulations when performing a duty or providing services; or (4) obtaining a citizen's personal information by purchasing, accepting or exchanging such information in violation of applicable rules and regulations.

Pursuant to the Notice of the General Office of the State Council on Issuing the Measures for the Management of Scientific Data issued by the General Office of the State Council on March 17, 2018, all entities and individuals shall comply with the relevant national laws and regulations as well as departmental rules in relation

to collecting, producing, using and managing scientific data, and shall not carry out activities endangering the national security, social public interests and others' legitimate rights and interests by using scientific data.

The PRC Civil Code, which was issued by the NPC on May 28, 2020 and became effective on January 1, 2021, provides that a natural person's personal information shall be protected by law, and the processing of personal information shall be subject to the principle of legitimacy, rightfulness and necessity, with no excessive processing.

The PRC Data Security Law was promulgated by the NPC on June 10, 2021 and will become effective on September 1, 2021. The PRC Data Security Law stipulates the measures to support and promote data security and development and establish and optimize the national data security management system, and clarifies organizations' and individuals' responsibilities in data security.

The Personal Data Protection Law (the "PDPL") was issued by NPC on August 20, 2021 and took effect on November 1, 2021, stipulates the scope of personal information and the ways of processing personal information, establishes rules for processing personal information and for transfer offshore, and clarifies the individual's rights and the processor's obligations in the processing of personal information. The PDPL also strengthens the punishment for those who illegally process personal information.

On July 7, 2022, the Cyberspace Administration of China published Outbound Data Transfer Security Assessment Measures, which became effective on September 1, 2022 and outlined the security assessment process for outbound data transfer.

#### Anti-bribery

According to the Anti-Unfair Competition Law of the PRC (the "Anti-Unfair Competition Law"), which was passed by the SCNPC on September 2, 1993, became effective on December 1, 1993 and was lastly amended on April 23, 2019, unfair competition refers to that in the course of production and operating activities, the operators disrupt the market competition order and damage the legitimate rights and interests of other operators or consumers in violation of the provisions of the Anti-unfair Competition Law. Pursuant to the Anti-unfair Competition Law, operators shall abide by the principle of voluntariness, equality, impartiality and integrity, and adhere to laws and business ethics during market transactions. Operators in violation of the Anti-unfair Competition Law shall bear corresponding civil, administrative or criminal liabilities depending on the specific circumstances.

Furthermore, pursuant to the Anti-Unfair Competition Law, business operators shall not use money and properties or other means to bribe the following organizations or individuals for the purpose of seeking transaction opportunities or competitive advantage: (1) staff of the counterparty; (2) organizations or individuals entrusted by the counterparty to handle the relevant matters; or (3) organizations or individuals who make use of their authority or influence to influence the transaction. Business operators may explicitly give discount to a counterparty, or pay commission to a middleman in their transactions. In such case, the business operators shall record the discount or commission in its accounts truthfully. Business operators who receive discount or commission shall also record it in their accounts truthfully. Bribery committed by a staff member of a business operator shall be deemed as bribery committed by the business operator, unless the business operator has evidence to prove that the conduct of the staff member is irrelevant to seeking transaction opportunities or competitive advantage for the business operator. Where a business operator violates these provisions and conducts bribe, the regulatory authorities shall confiscate its illegal income and impose a fine ranging from RMB100,000 to RMB3,000,000. Severe violations shall have their business licenses revoked.

According to the Interim Provisions on the Prohibition of Commercial Bribery (the "Prohibition Commercial Bribery Provisions"), which was promulgated by the State Administration of Industry and Commerce on November 15, 1996, commercial bribery refers to an act of offering money or property or using other means by an operator to the other entity or individual for the purposes of selling or buying goods, among which "other means" refer to the means used to provide any types of benefits other than money or property, such as offering overseas or domestic travel. According to the Anti-Unfair Competition Law and the Prohibition Commercial Bribery Provisions, regulatory authorities may impose fines depending on the seriousness of the cases and if there is any illegal income, such income shall be confiscated.

Pharmaceutical companies involved in a criminal investigation or administrative proceedings related to bribery are listed in the Adverse Records of Commercial Briberies by its provincial health and family planning administrative department. Pursuant to the Provisions on the Establishment of Adverse Records of Commercial Briberies in the Medicine Purchase and Sales Industry which became effective in March 2014, provincial health and family planning administrative departments formulate the implementing measures for establishment of Adverse Records of Commercial Briberies. If a pharmaceutical company is listed in the Adverse Records of Commercial Briberies of a province for the first time, its production will not be allowed to be purchased by public medical institutions in this province within the next two years after the relevant list is published. A pharmaceutical company will not be penalized by the relevant PRC government authorities merely by virtue of having contractual relationships with distributors or third-party promoters who are engaged in bribery activities, so long as such pharmaceutical company and its employees are not utilizing the distributors or third-party promoters for the implementation of, or acting in conjunction with them in, the prohibited bribery activities. In addition, a pharmaceutical company is under no legal obligation to monitor the operating activities of its distributors and third-party promoters, and will not be subject to penalties or sanctions by relevant PRC government authorities as a result of its failure to monitor their operating activities.

According to the Criminal Law of the PRC, which was lastly amended on December 26, 2020 and became effective on March 1, 2021, whoever, for the purpose of seeking illegitimate benefits, gives money or property to a staff member of a company, an enterprise or any other entity, shall be sentenced to imprisonment or criminal detention and shall also be fined, depending on the amount involved. An act of giving money or any property to state functionaries in order to seek illegitimate benefits shall be considered a crime of offering bribes. Whoever commits the crime of offering bribes shall be sentenced to imprisonment or criminal detention and shall also be fined and subject to confiscation of property, depending on severity of the situations.

#### *Regulations relating to national medical insurance program*

National Medical Insurance Program The national medical insurance program was adopted pursuant to the Decision of the State Council on the Establishment of the Urban Employee Basic Medical Insurance Program issued by the State Council on December 14, 1998, under which all employers in urban cities are required to enroll their employees in the Urban Employee Basic Medical Insurance Program and the insurance premium is jointly contributed by the employers and employees. Pursuant to the Opinions on the Establishment of the New Rural Cooperative Medical System forwarded by the General Office of the State Council on January 16, 2003, China launched the New Rural Cooperative Medical System to provide medical insurance for rural residents in selected areas which has spread to the whole nation thereafter. The State Council promulgated the Guiding Opinions of the State Council about the Pilot Urban Resident Basic Medical Insurance on July 10, 2007, under which urban residents of the pilot district, rather than urban employees, may voluntarily join Urban Resident Basic Medical Insurance. In 2015, the PRC government announced the Outline for the Planning of the National Medical and Health Service System (2015-2020) which aims to establish a basic medical and health care system that covers both rural and urban citizens by 2020.

#### *Regulations Relating to Importation and Exportation of Goods*

According to the Administrative Provisions on the Recordation of Customs Declaration Entities of the PRC, promulgated by the General Administration of Customs of the PRC on November 19, 2021 and came into force on January 1, 2022, the consignee, consignor and customs declaration enterprise of import and export goods filed with the customs in accordance with these regulations may handle customs declaration business within the customs territory of the PRC. Consignors and consignees of imported and exported goods shall go through customs declaration entity recordation formalities with the competent customs departments in accordance with the applicable provisions. Consignors and consignors of import and export goods and customs declaration enterprises that apply for recordation shall obtain the qualification of market entities; among which, the consignees and consignors of import and export goods shall also obtain recordation of foreign trade operators if they apply for recordation.

#### *Regulations relating to product liability*

Pursuant to the Product Quality Law of the PRC promulgated on February 22, 1993 and latest amended on December 29, 2018 by the SCNPC, the seller shall be responsible for the repair, replacement or return of the

product sold if (1) the product sold does not possess the properties for use that it should possess, and no prior and clear indication is given of such a situation; (2) the product sold does not conform to the applied product standard as carried on the product or its packaging; or (3) the product sold does not conform to the quality indicated by such means as a product description or physical sample. If a consumer incurs losses as a result of the purchased product, the seller shall compensate for such losses.

The Law of the PRC on the Protection of the Rights and Interests of Consumers was promulgated on October 31, 1993 and was amended on August 27, 2009 and October 25, 2013 to protect consumers' rights when they purchase or use goods and accept services. All business operators must comply with this law when they manufacture or sell goods and/or provide services to customers. Under the amendments made on October 25, 2013, all business operators must pay high attention to protecting customers' privacy and must strictly keep confidential any consumer information they obtain during their business operations. In addition, in extreme situations, medical product manufacturers and operators may be subject to criminal liability if their goods or services lead to the death or injuries of customers or other third parties.

Pursuant to the PRC Civil Code which was promulgated by the NPC on May 28, 2020 and became effective on January 1, 2021, where a patient suffers damage due to defects in drugs, he may seek compensation from the drug marketing authorization holder or also from the medical institution. Where the patient seeks compensation from the medical institution, the medical institution, after it has made the compensation, shall have the right to recover the compensation from the liable drug marketing authorization holder.

#### *Regulations relating to foreign investment*

##### Foreign investment

Investment activities in the PRC by foreign investors were principally governed by the Special Administrative Measures (Negative List) for Access of Foreign Investment (2021 version) (the "Negative List") and Catalogue of Industries for Encouraging Foreign Investment (2020 version) (the "Encouraging List"). The Negative List, which came into effect on January 1, 2022, sets out special administrative measures in respect of the access of foreign investments in a centralized manner, and the Encouraging List which came into effect on January 27, 2021, sets out the encouraged industries for foreign investment.

##### Foreign-invested enterprises

On December 29, 1993, the SCNPC issued the PRC Company Law (the "Company Law"), which was last amended on October 26, 2018. The Company Law regulates the establishment, operation and management of corporate entities in China and classifies companies into limited liability companies and limited companies by shares. According to the Foreign Investment Law of the PRC promulgated by the SCNPC on March 15, 2019 and came into effect as of January 1, 2020, the state shall implement the management systems of pre-establishment national treatment and negative list for foreign investment, and shall give national treatment to foreign investment beyond the negative list. Simultaneously, Sino-foreign Equity Joint Ventures of the PRC, the Wholly Foreign-owned Enterprises Law of the PRC and Sino-foreign Cooperative Joint Ventures of the PRC have been repealed since January 1, 2020.

On December 30, 2019, MOFCOM and the SAMR issued the Measures for the Reporting of Foreign Investment Information, which came into effect on January 1, 2020 and replaced the Interim Measures for the Recordation Administration of the Incorporation and Change of Foreign-Invested Enterprises, for carrying out investment activities directly or indirectly in PRC, the foreign investors or foreign-invested enterprises shall submit investment information to the commerce authorities pursuant to these measures.

#### *Regulations relating to environmental protection and fire preventions*

##### Environment protection

The Environmental Protection Law of the PRC (the "Environmental Protection Law"), which was promulgated by the SCNPC on December 26, 1989, came into effect on the same day and last amended on April 24, 2014, outlines the authorities and duties of various environmental protection regulatory agencies. The Ministry of Environmental Protection is authorized to issue national standards for environmental quality

and emissions, and to monitor the environmental protection scheme of the PRC. Meanwhile, local environment protection authorities may formulate local standards which are more rigorous than the national standards, in which case, the concerned enterprises must comply with both the national standards and the local standards.

#### Environmental impact appraisal

According to the Administration Rules on Environmental Protection of Construction Projects, which was promulgated by the State Council on November 29, 1998, amended on July 16, 2017 and became effective on October 1, 2017, depending on the impact of the construction project on the environment, a construction employer shall submit an environmental impact report or an environmental impact statement, or file a registration form. As to a construction project, for which an environmental impact report or the environmental impact statement is required, the construction employer shall, before the commencement of construction, submit the environmental impact report or the environmental impact statement to the relevant authority at the environmental protection administrative department for approval. If the environmental impact assessment documents of the construction project have not been examined or approved upon examination by the approval authority in accordance with the law, the construction employer shall not commence the construction.

According to the Environmental Impact Appraisal Law of PRC (the “Environmental Impact Appraisal Law”), which was promulgated by the SCNPC on October 28, 2002, amended on July 2, 2016 and December 29, 2018, for any construction projects that have an impact on the environment, an entity is required to produce either a report, or a statement, or a registration form of such environmental impacts depending on the seriousness of effect that may be exerted on the environment.

#### Fire prevention design and acceptance

The Fire Prevention Law of the PRC (the “Fire Prevention Law”), was adopted on April 29, 1998 and latest amended on April 29, 2021. According to the Fire Prevention Law, for special construction projects stipulated by the housing and urban-rural development authority of the State Council, the developer shall submit the fire safety design documents to the housing and urban-rural development authority for examination, while for construction projects other than those stipulated as special development projects, the developer shall, at the time of applying for the construction permit or approval for work commencement report, provide the fire safety design drawings and technical materials which satisfy the construction needs. According to Interim Regulations on Administration of Examination and Acceptance of Fire Control Design of Construction Projects, an examination system for fire prevention design and acceptance only applies to special construction projects, and for other projects, a record-filing and spot check system would be applied.

#### *Regulations relating to employment, social securities and production safety*

##### Employment

The major PRC laws and regulations that govern employment relationship are the Labor Law of the PRC (the “Labor Law”) (issued by the SCNPC on July 5, 1994, came into effect on January 1, 1995 and revised on August 27, 2009 and December 29, 2018), the Labor Contract Law of the PRC or the Labor Contract Law (promulgated by the SCNPC on June 29, 2007 and became effective on January 1, 2008, and then amended on December 28, 2012 and became effective on July 1, 2013) and the Implementation Rules of the Labor Contract Law of the PRC (the “Implementation Rules of the Labor Contract Law”) (issued by the State Council on September 18, 2008 and came into effect on the same day). According to the aforementioned laws and regulations, labor relationships between employers and employees must be established in written form. The laws and regulations above impose stringent requirements on the employers in relation to entering into fixed-term employment contracts, hiring of temporary employees and dismissal of employees.

##### Social securities

According to the Social Insurance Law of PRC, which issued by the SCNPC on October 28, 2010 and came into effect on July 1, 2011 and was newly revised on December 29, 2018, enterprises and institutions in the PRC shall provide their employees with welfare schemes covering pension insurance, unemployment insurance, maternity insurance, occupational injury insurance, medical insurance and other welfare plans. The employer

shall apply to the local social insurance agency for social insurance registration within 30 days from the date of its formation. And it shall, within 30 days from the date of employment, apply to the social insurance agency for social insurance registration for the employee. Meanwhile, the Interim Regulation on the Collection and Payment of Social Insurance Premiums (issued by the State Council on January 22, 1999 and came into effect on the same day and was recently revised on March 24, 2019) prescribes the details concerning the social securities.

#### Housing provident fund

According to the Regulation Concerning the Administration of Housing Provident Fund, implemented since April 3, 1999 and amended on March 24, 2002 and March 24, 2019, any newly established entity shall make deposit registration at the housing accumulation fund management center within 30 days as of its establishment. After that, the entity shall open a housing accumulation fund account for its employees in an entrusted bank. Within 30 days as of the date an employee is recruited, the entity shall make deposit registration at the housing accumulation fund management center and seal up the employee's housing accumulation fund account in the bank mentioned above within 30 days from termination of the employment relationship.

#### Production safety

Pursuant to the Production Safety Law of the PRC amended by the Standing Committee of the NPC on June 10, 2021 and coming into effect on September 1, 2021, an enterprise shall (1) provide production safety conditions as stipulated in this law and other relevant laws, administrative regulations, national and industry standards, (2) establish a comprehensive production safety accountability system and production safety rules, (3) develop production safety standards to ensure production safety and (4) establish safety risk classification management and control system, and take corresponding control measures according to the safety risk classification. Any entity that fails to provide required production safety conditions is prohibited from engaging in production activities. The person-in-charge of an enterprise shall be fully responsible for the safety of production of the enterprise.

#### Regulations relating to intellectual properties

##### Patents

According to the Patent Law of the PRC, promulgated by the SCNPC on March 12, 1984 and further amended on September 4, 1992, August 25, 2000, December 27, 2008 and came into effect on October 1, 2009 and the Implementing Rules of the Patent Law of the PRC, promulgated by the China Patent Bureau Council on January 19, 1985, and last amended on January 9, 2010 and came into effect on February 1, 2010, the term "invention-creations" refers to inventions, utility models and designs. The duration of a patent right for inventions shall be 20 years and the duration of a patent right for utility models and designs shall be 10 years, both commencing from the filing date. In the event that a dispute arises due to a patent being exploited without the prior authorization of the patentee, that is to say an infringement upon the patent right of the patentee. In addition, pursuant to the Patent Law of the PRC which was released on October 17, 2020 and will come into effect on June 1, 2021, the duration of a patent right for designs shall be 15 years, all commencing from the application date.

##### Trademarks

Pursuant to the Trademark Law of the PRC which was promulgated on August 23, 1982 and last amended on April 23, 2019 and came into effect on November 1, 2019, the Implementation Regulations of the Trademark Law of PRC which was issued on August 3, 2002 and amended on April 29, 2014, the Trademark Office under the State Administration for Industry and Commerce of the PRC (the "Trademark Office") shall handle trademark registrations and grant a term of ten years to registered trademarks, which may be renewed for additional ten year period upon request from the trademark owner. The Trademark Law of the PRC has adopted a "first-to-file" principle with respect to trademark registration. Where an application for trademark for which application for registration has been made is identical or similar to another trademark which has already been registered or is under preliminary examination and approval for use on the same kind of or



similar commodities or services, the application for registration of such trademark may be rejected. Any person applying for the registration of a trademark may not prejudice the existing right of others, nor may any person register in advance a trademark that has already been used by another party and has already gained a “sufficient degree of reputation” through such party’s use. A trademark registrant may, by entering into a trademark licensing contract, license another party to use its registered trademark. Where another party is licensed to use a registered trademark, the licensor shall report the license to the Trademark Office for recordation, and the Trademark Office shall publish it. An unrecorded license may not be used as a defense against a third party in good faith.

#### Domain names

In accordance with the Measures for the Administration of Internet Domain Names which was issued by the Ministry of Information Industry on August 24, 2017 and came into effect on November 1, 2017, the Ministry of Information Industry is responsible for supervision and administration of domain name services in the PRC. Communication administrative bureaus at provincial levels shall conduct supervision and administration of the domain name services within their respective administrative jurisdictions. Domain name registration services shall, in principle, be subject to the principle of “first apply, first register.” A domain name registrar shall, in the process of providing domain name registration services, ask the applicant for which the registration is made to provide authentic, accurate and complete identity information on the holder of the domain name and other domain name registration related information.

#### *Regulations relating to foreign exchange and overseas investment*

On January 29, 1996, the State Council promulgated the Administrative Regulations on Foreign Exchange of the PRC which became effective on April 1, 1996 and was amended on January 14, 1997 and August 5, 2008. Foreign exchange payments under current account items shall, pursuant to the administrative provisions of the foreign exchange control department of the State Council on payments of foreign currencies and purchase of foreign currencies, be made using self-owned foreign currency or foreign currency purchased from financial institutions engaging in conversion and sale of foreign currencies by presenting the valid document.

On November 19, 2012, the State Administration of Foreign Exchange (“SAFE”) issued the Circular of Further Improving and Adjusting Foreign Exchange Administration Policies on Foreign Direct Investment (the “SAFE Circular 59”), which came into effect on December 17, 2012 and was revised on May 4, 2015, October 10, 2018 and partially abolished on December 30, 2019. The SAFE Circular 59 aims to simplify the foreign exchange procedure and promote the facilitation of investment and trade. According to the SAFE Circular 59, the opening of various special purpose foreign exchange accounts, such as pre-establishment expenses accounts, foreign exchange capital accounts and guarantee accounts, the reinvestment of RMB proceeds derived by foreign investors in the PRC, and remittance of foreign exchange profits and dividends by a foreign-invested enterprise to its foreign shareholders no longer require the approval or verification of SAFE, as well multiple capital accounts for the same entity may be opened in different provinces. Later, SAFE promulgated the Circular on Further Simplifying and Improving Foreign Exchange Administration Policies in Respect of Direct Investment in February 2015, which was partially abolished in December 2019 and prescribed that the bank instead of SAFE can directly handle the foreign exchange registration and approval under foreign direct investment while SAFE and its branches indirectly supervise the foreign exchange registration and approval under foreign direct investment through the bank.

On October 23, 2019, SAFE promulgated the Notice on Further Facilitating Cross-Board Trade and Investment, which became effective on the same date (except for Article 8.2, which became effective on January 1, 2020). The notice cancelled restrictions on domestic equity investments made with capital funds by non-investing foreign-funded enterprises. In addition, restrictions on the use of funds for foreign exchange settlement of domestic accounts for the realization of assets have been removed and restrictions on the use and foreign exchange settlement of foreign investors’ security deposits have been relaxed. Eligible enterprises in the pilot area are also allowed to use revenues under capital accounts, such as capital funds, foreign debts and overseas listing revenues for domestic payments without providing materials to the bank in advance for authenticity verification on an item by item basis, while the use of funds should be true, in compliance with applicable rules and conforming to the current capital revenue management regulations.

According to the Notice on Further Optimizing the Cross-border RMB Policy and Supporting the Stabilization of Foreign Trade and Foreign Investment issued by the People's Bank of China, the NDRC, MOFCOM, the State-owned Assets Supervision and Administration Commission of the State Council, the China Banking and Insurance Regulatory Commission and SAFE on December 31, 2020 which came into effect on February 4, 2021, the RMB income from the capital account of domestic institutions could be used within the business scope approved by the relevant state departments when the following requirements are met: (1) it shall not be used directly or indirectly for expenditures outside the business scope of the enterprise or the expenditures prohibited by national laws and regulations; (2) unless expressly provided otherwise, it shall not be used directly or indirectly for securities investment; (3) unless expressly permitted in the business scope, it shall not be used for giving out loans to the non-associated enterprises; and (4) it shall not be used for constructing or purchasing the real estate for non-self-use (except for real estate development enterprises). In addition, the non-investment oriented foreign investment enterprises could make domestic reinvestment with RMB capital in accordance with the law, provided they comply with current regulations and the domestic investment projects are true and compliant.

#### *Regulations relating to M&A*

According to the M&A Rules, which was jointly issued by MOFCOM, the State Assets Supervision and Administration Commission of State Council, SAT, the SAMR, the CSRC, and SAFE, on August 8, 2006 and amended by MOFCOM on June 22, 2009, among other things, (1) the purchase of an equity interest or subscription to the increase in the registered capital of non-foreign-invested enterprises, (2) the establishment of foreign-invested enterprises to purchase and operate the assets of non-foreign-invested enterprises, or (3) the purchase of the assets of nonforeign-invested enterprises and the use of such assets to establish foreign-invested enterprises to operate such assets, in each case, by foreign investors shall be subject to the M&A Rules. Particularly, application shall be made for examination and approval of the acquisition of any company in China affiliating to a domestic company, enterprise or natural person, which is made in the name of an oversea company established or controlled by such domestic company, enterprise or natural person.

#### *Regulations relating to taxation*

##### Enterprise income tax

The Enterprise Income Tax Law of the PRC (the "EIT Law"), which was promulgated by the NPC on March 16, 2007, came into effect on January 1, 2008 and amended on February 24, 2017 and December 29, 2018, as well as the Implementation Rules of the EIT Law, or the Implementation Rules, promulgated by the State Council on December 6, 2007, came into force on January 1, 2008 and amended on April 23, 2019, are the principal law and regulation governing enterprise income tax in the PRC. According to the EIT Law and its Implementation Rules, enterprises are classified into resident enterprises and non-resident enterprises. Resident enterprises refer to enterprises that are legally established in the PRC, or are established under foreign laws but whose actual management bodies are located in the PRC, and non-resident enterprises refer to enterprises that are legally established under foreign laws and have set up institutions or sites in the PRC but with no actual management body in the PRC, or enterprises that have not set up institutions or sites in the PRC but have derived incomes from the PRC. A uniform income tax rate of 25% applies to all resident enterprises and non-resident enterprises that have set up institutions or sites in the PRC to the extent that such incomes are derived from their set-up institutions or sites in the PRC, or such income are obtained outside the PRC but have an actual connection with the set-up institutions or sites, and non-resident enterprises that have not set up institutions or sites in the PRC or that have set up institutions or sites but the incomes obtained by the said enterprises have no actual connection with the set-up institutions or sites, shall pay enterprise income tax at the rate of 10% in relation to their income sources from the PRC.

##### Value-added tax

The major PRC law and regulation governing value-added tax are the Interim Regulations on Value-added Tax of the PRC (issued on December 13, 1993 by the State Council, came into effect on January 1, 1994, and revised on November 10, 2008, February 6, 2016 and November 19, 2017), as well as the Implementation Rules for the Interim Regulations on Value-Added Tax of the PRC (issued on December 25, 1993 by the Ministry of Finance of the PRC (the "MOF"), came into effect on the same day and revised on December 15,

2008 and October 28, 2011), any entities and individuals engaged in the sale of goods, supply of processing, repair and replacement services, and import of goods within the territory of the PRC are taxpayers of Value-Added Tax (the “VAT”) and shall pay the VAT in accordance with the law and regulation. The rate of VAT for sale of goods is 17% unless otherwise specified, such as the rate of VAT for sale of transportation is 11%. With the VAT reforms in the PRC, the rate of VAT has been changed several times. The MOF and the SAT issued the Notice on Adjusting VAT Rates on April 4, 2018 to adjust the tax rates of 17% and 11% applicable to any taxpayer’s VAT taxable sale or import of goods to 16% and 10%, respectively, this adjustment became effect on May 1, 2018. Subsequently, the MOF, the SAT and the General Administration of Customs jointly issued the Announcement on Relevant Policies for Deepening the VAT Reform on March 20, 2019 to make a further adjustment, which came into effect on April 1, 2019. The tax rate of 16% applicable to the VAT taxable sale or import of goods shall be adjusted to 13%, and the tax rate of 10% applicable thereto shall be adjusted to 9%. Moreover, according to the Announcement of the SAT on the VAT Issues Concerning the Sale of Biological Products by Drug Trading Enterprises issued on May 28, 2012, if a drug trading enterprise which is a general taxpayer for VAT sells biological products, it could choose a simple method to calculate the VAT to pay based on the sales of biological products and a collection rate of 3%.

### ***Laws and regulations in Singapore***

#### *Laws and regulations relating to clinical trials*

In Singapore, the Health Sciences Authority (“HSA”), a statutory board of the Ministry of Health of Singapore, regulates the conduct of clinical trials of therapeutic products and medicinal products under the Health Products Act (Chapter 122D) and Medicines Act (Chapter 176) and their subsidiary legislations (including Health Products (Clinical Trials) Regulations (“HPCTR”) and the Medicines (Clinical Trials) Regulations 2016 (“MCTR,” together with the HPCTR, collectively, the “Regulations”), respectively. Certain types of clinical research such as observational clinical trials of therapeutic products and medicinal products and clinical trials on medical devices are not regulated by HSA.

The Regulations provide that every clinical trial must have one and only one sponsor. However, HSA may, in its discretion, allow more than one sponsor for a clinical trial. A “sponsor” is defined under the Regulations as a person who takes responsibility for the initiation, management or financing of a clinical trial. Under the Regulations, the sponsor of a clinical trial is required, among others:

- (1) in the case of clinical trial of medicinal products, to apply for and obtain a clinical trial certificate for each principal investigator of the clinical trial before the commencement of the trial;
- (2) in the case of clinical trial of medicinal products, to apply for and obtain authorization by HSA for the clinical trial or notify HSA of the clinical trial and receipt of HSA’s acceptance of the notification before the commencement of the trial;
- (3) not to make substantial amendments to the trial except with approval of HSA;
- (4) to notify HSA of the trial status, suspension, termination and conclusion, and submit final report regarding the trial status within stipulated timelines under respective Regulations;
- (5) to ensure that information in the investigator’s brochure for the trial is concise, objective and kept up to date;
- (6) to ensure that the clinical trial is conducted under supervision of qualified private investigator;
- (7) to ensure that the clinical trial is only conducted at the specified trial site;
- (8) to carry out functions of the sponsor in accordance with principles of good clinical practice (“GCP”) set out in the First Schedule of the respective Regulations;
- (9) to put and keep in place arrangements to ensure compliance with principles of GCP;
- (10) to notify HSA of serious breaches and urgent safety measures taken to protect subjects against immediate hazard within stipulated timelines under the respective Regulations;

- (11) to keep record of clinical trials;
- (12) to ensure that all investigational and auxiliary medicinal product used in the trial are labelled in accordance with the labelling requirements set out in Second Schedule of the respective Regulations; and
- (13) to report unexpected serious adverse drug reactions to HSA within the stipulated timelines under the respective Regulations.

The sponsor may delegate all or any of the sponsor's functions under the Regulations to any person, but any such arrangement does not affect the responsibility of the sponsor.

HSA has power under the Regulations to suspend or terminate a clinical trial, or any part of a clinical trial if it has reasonable grounds to suspect that (a) any information provided in respect of any application for a clinical trial certificate for the trial is false or misleading; (b) any sponsor, principal investigator or person assisting the principal investigator has contravened, is contravening or is likely to contravene any condition to which any clinical trial certificate issued for the trial is subject or any provision of the Regulations; (c) any ground for the conduct of the trial on the basis of scientific validity is no longer applicable or true or (d) the continuance of the trial will compromise the safety of any subject of the trial. In such event, the sponsor and a principal investigator must ensure that the suspension or termination is adhered to by all persons involved in the trial.

A person who is guilty of an offence under MCTR shall be liable on conviction to a fine not exceeding \$5,000 or to imprisonment for a term not exceeding two years or to both.

A person who is guilty of an offence under HPCTR shall be liable on conviction to a fine not exceeding \$10,000 or \$20,000 depending on the offence or to imprisonment for a term not exceeding six or 12 months depending on the offence or to both.

#### *Laws and regulations relating to clinical research material*

The manufacture, import and supply of therapeutic products and medicinal products used as a clinical research material in clinical trials in Singapore is governed by the Health Products Act (Chapter 122D), Medicines Act (Chapter 176) and their subsidiary legislations (including Health Products (Therapeutic Products as Clinical Research Materials) Regulations 2016 ("HPTPCRM"), Medicines (Medicinal Products as Clinical Research Materials) Regulations 2016 ("MMPCRM", together with the HPTPCRM, collectively, the "CRM Regulations")), respectively.

The Health Products Act (Chapter 122D) and Medicines Act (Chapter 176) provides that no person shall import, manufacture, assemble or sell (by way of wholesale dealing) any health product or medicinal product without a valid license (product license, import license, manufacturer's license or wholesale dealer's license where applicable) and that health products must also not be supplied without product registration. Under the CRM Regulations, certain health product or medicinal products (including among others, those that are manufactured, assembled, imported or supplied as clinical research materials) are exempted from the above licensing requirements, subject to the importer or manufacturer (as the case may be) of clinical research materials giving notice of the import or supply (as the case may be) ("CRM Notification") to HSA before importing or supplying (as the case may be) the clinical research materials in accordance with the requirements of the CRM Regulations.

According to the clinical trial guidance on clinical research materials published by HSA on 2 May 2017, sponsor of clinical trials (that are regulated by HSA and for which imported or locally manufactured clinical research material is to be used) should submit the CRM Notification on behalf of the importer or local manufacturer to HSA at the time of initial application for clinical trial certificate or authorization or notification (as the case may be) or where such information is unavailable at the time of application, by way of amendment to the application. Before the CRM Regulations came into force, clinical trial material import permits were issued to clinical trial sponsors to facilitate importation of medicinal products for use in the approved drug trials.

Under the CRM Regulations, the sponsor is required to ensure that clinical research materials are only used in accordance with the research protocol, and where the research requires the approval of an institutional review

board (“IRB”), only after approval has been obtained from IRB. Unless otherwise allowed by HSA, the sponsor is also required to ensure that any unused clinical research material obtained for the research is disposed of or exported within six months of the conclusion or termination of the clinical research. The sponsor must keep records relating to all clinical research materials that are put to some other use, disposed of or exported for the prescribed period and produce the records for inspection when required by HSA and report unexpected serious adverse drug reactions to HSA within the stipulated timelines.

The import of clinical research materials comprising controlled drugs and psychotropic substances, poisons or radiopharmaceuticals into Singapore is subject to additional licensing requirements.

A person who is guilty of an offence under MMPCRM shall be liable on conviction to a fine not exceeding \$5,000 or to imprisonment for a term not exceeding two years or to both.

A person who is guilty of an offence under HPTPCRM shall be liable on conviction to a fine not exceeding \$10,000 or \$20,000 depending on the offence or to imprisonment for a term not exceeding six or 12 months depending on the offence or to both.

*Laws and regulations relating to confidentiality of personal data collected and used in clinical trials*

As stated in the First Schedule (principles of good clinical practice) of the Health Products (Clinical Trials) Regulations (“HPCTR”) and the Medicines (Clinical Trials) Regulations 2016 (“MCTR”, together with the HPCTR, collectively, the “Regulations”), the confidentiality of records that could identify clinical trial subjects must be protected, respecting the privacy and confidentiality rules in accordance with any applicable written law or rule or principle of law.

The Personal Data Protection Act 2012 establishes the Singapore regime for the protection of personal data (i.e. data, whether true or not, about an individual who can be identified from that data or other information accessible to the relevant organisation) and seeks to ensure that organisations comply with a baseline standard of protection for personal data of individuals.

The nine data protection obligations are summarised as follows:

- (1) purpose limitation obligation — personal data must be collected, used or disclosed only for purposes that a reasonable person would consider appropriate in the circumstances, and if applicable, have been notified to the individual concerned;
- (2) notification obligation — individuals must be notified of the purposes for the collection, use or disclosure of their personal data, prior to such collection, use or disclosure;
- (3) consent obligation — the consent of individuals must be obtained for any collection, use or disclosure of their personal data, unless exceptions apply. Additionally, an organisation must allow the withdrawal of consent which has been given or is deemed to have been given;
- (4) access and correction obligations — when requested by an individual and unless exceptions apply, an organisation must: (i) provide that individual with access to his personal data in the possession or under the control of the organisation and information about the ways in which his personal data may have been used or disclosed during the past year; and/or (ii) correct an error or omission in his personal data that is in the possession or under the control of the organisation;
- (5) accuracy obligation — an organisation must make reasonable efforts to ensure that personal data collected by or on its behalf is accurate and complete if such data is likely to be used to make a decision affecting the individual or if such data will be disclosed to another organisation; and
- (6) protection obligation — an organisation must implement reasonable security arrangements for the protection of personal data in its possession or under its control;
- (7) retention limitation obligation — an organisation must not keep personal data for longer than it is necessary to fulfil: (i) the purposes for which it was collected; or (ii) a legal or business purpose;
- (8) transfer limitation obligation — personal data must not be transferred out of Singapore except in accordance with the requirements prescribed under the PDPA; and

- (9) openness obligation — an organisation must implement the necessary policies and procedures in order to meet the obligations under the PDPA and shall make information about its policies and procedures publicly available.

Non-compliance may lead to financial penalties, civil liability or criminal liability. The Singapore regulator, the Personal Data Protection Commission, also has broad powers to order the organisations to comply with the provisions of the PDPA.

## YS BIOPHARMA'S MANAGEMENT'S DISCUSSION AND ANALYSIS OF FINANCIAL CONDITION AND RESULTS OF OPERATIONS

*The following discussion and analysis provide information which YS Biopharma's management believes is relevant to an assessment and understanding of YS Biopharma's results of operations and financial condition. This discussion and analysis should be read together with the section entitled "Unaudited Pro Forma Condensed Combined Financial Information" and YS Biopharma's financial statements and notes thereto included elsewhere in this prospectus. In addition to historical financial information, this discussion contains forward-looking statements based upon YS Biopharma's current expectations that involve risks and uncertainties. YS Biopharma's actual results could differ materially from such forward-looking statements as a result of various factors, including those set forth under "Risk Factors" and elsewhere in this proxy statement/prospectus.*

### Overview

YS Group is a global biopharmaceutical company dedicated to discovering, developing, manufacturing and commercializing new generations of vaccines and therapeutic biologics for infectious diseases and cancer.

YS Group commercializes vaccines with significant revenue and growth potential. YS Group take pride in YS Group's marketed vaccine product, YSJA™ rabies vaccine, which was the first aluminum-free lyophilized rabies vaccine launched in China. As of the date of this proxy statement/prospectus, approximately 97 million doses of YSJA™ rabies vaccine have been administered for post-exposure protection against rabies. With YS Group's track record of commercialization, YSJA™ rabies vaccine has achieved high production scalability and wide market recognition. Since YS Group launched its production at its current GMP-compliant facilities in February 2020 and as of September 30, 2022, YS Group had sold more than 16 million doses of YSJA™ rabies vaccines to approximately 1,625 county-level CDCs in China.

In addition to the commercialized YSJA™ rabies vaccine, YS Group also has a pipeline of vaccine candidates powered by YS Group's proprietary PIKA immunomodulating technology platform. YS Group's proprietary PIKA immunomodulating technology platform is core to the discovery and development of innovative biologics and will continue to be instrumental to YS Group's success. As of the date of this proxy statement prospectus, YS Group have a robust portfolio of seven innovative product candidates: (1) four product candidates under various clinical development stages, including PIKA rabies vaccine, PIKA recombinant COVID-19 vaccine, PIKA YS-ON-001 and PIKA YS-HBV-001, and (2) four preclinical stage product candidates, targeting HBV, influenza, rabies and cancer with enormous medical demand. In addition, YS Group is working on a series of therapeutic targets and products at the discovery stage. YS Group has been granted about 70 patents across more than 30 countries and regions relating to its PIKA immunomodulating technology and prophylactic and therapeutic product innovations. YS Group believes that its PIKA immunomodulating technology platform has the potential to nurture a wide variety of innovative vaccines and therapeutic biologics.

YS Group has been manufacturing YSJA™ rabies vaccine and clinical trial materials in its current GMP-compliant facilities, supported by highly efficient and automated process to ensure high product quality and production efficiency. YS Group has also obtained patents in relation to YS Group's manufacturing techniques and devices. YS Group's current manufacturing facilities have an annual production capacity of approximately 15 million doses of YSJA™ rabies vaccine. Since YS Group started its production at its GMP-compliant facilities in February 2020, and as of September 30, 2022, YS Group had manufactured approximately 26 million doses of YSJA™ rabies vaccine. YS Group became one of the important producers and suppliers of rabies vaccine in China and became self-sufficient in production of YSJA rabies vaccines. In 2022, YS Group obtained its Drug Manufacturing License from the NMPA for YS Group's preparation for commercialization of PIKA recombinant COVID-19 vaccine. YS Group has established a comprehensive and highly effective commercialization infrastructure, underpinned by YS Group's experienced in-house commercialization team and professional service providers. As of September 30, 2022, YS Group's in-house commercialization team diligently managed its sales and marketing activities across approximately 336 cities in China.

YS Group believes that its product candidates, if approved and launched, will benefit from the operating leverage enabled by YS Group's accumulated commercialization experience and scalable commercialization infrastructure to realize market success.

As of September 30, 2022, YS Group had an accumulated deficit of \$235.7 million. YS Group has funded its operations primarily with proceeds from revenues generated from the sales of its marketed product, YSJA™ rabies vaccine, borrowings under its loan facilities, and private placements of its shares.

### **Response to COVID-19**

The full extent to which the ongoing COVID-19 pandemic will directly or indirectly impact YS Group's business, results of operations and financial condition, including expenses, clinical trials and research and development costs, will depend on future developments that are highly uncertain, including as a result of new information that may emerge concerning COVID-19 and the actions taken to contain or treat COVID-19, as well as the economic impact on local, regional, national and international markets. These situations, or others associated with COVID-19, could cause delays in YS Group's clinical trial plans, its ability to obtain regulatory approvals, and could increase expected costs, all of which could have a material adverse effect on its business and financial condition. YS Group implemented work-from-home and other policies and are adapting to evolving health regulations. Because of the nature of YS Group's current operations, COVID-19 has not had a significant impact on its business, results of operations or financial condition.

### **Key Factors Affecting Results of Operations**

If the vaccine industry in China does not grow as expected or declines, the results of operations could be materially and adversely affected. If YS Group's marketed product and product candidates as well as the related manufacturing, storage, testing, delivery and other procedures do not meet the required quality standards, YS Group's business could be harmed, and its revenue and profitability could be materially and adversely affected.

Preclinical or clinical trials involve a lengthy and expensive process with uncertain outcomes. YS Group may not be able to achieve its projected development goal of its product candidates in a timely manner or at all, which may materially and adversely affect YS Group's business, financial condition, results of operations and prospects.

The biopharmaceutical industry is highly regulated. The relevant regulations and policies are complex and regional and subject to changes from time to time. YS Group's ability to obtain and maintain these regulatory approvals is uncertain. Any change in government regulation and policy may place additional burdens on YS Group's business and have a material adverse effect on YS Group's financial condition and results of operations.

#### ***YS Group's ability to increase the sales of its marketed product***

YS Group commenced the production of its marketed product, YSJA™ rabies vaccine with its GMP-compliant manufacturing facilities in February 2020 and the sales and marketing in October 2020. Since October 2020 and as of September 30, 2022, YS Group had sold approximately 16 million doses of product to over 1,625 county-level CDCs in China. The sales volume of YS Group's marketed product is expected to have a significant impact on its results of operations. YS Group's ability to increase the sales of its marketed product depends on whether YS Group is able to effectively implement its marketing strategies. YS Group intends to drive the full-scale commercialization of YSJA™ rabies vaccine to capture the significant unmet demand for rabies vaccine in China and Southeast Asia. YS Group plans to expand its manufacturing facilities by establishing manufacturing facilities in Shenyang (China) and Singapore and enhance YS Group's sales efforts by expanding its commercialization team, marketing service providers and county level CDC coverage.

#### ***YS Group's ability to commercialize its product candidates***

YS Group's business and results of operations will be dependent on the receipt of regulatory approval for and successful commercialization of its product candidates. Leveraging its proprietary PIKA immunomodulating technology platform, YS Group has developed a robust pipeline of product candidates targeting viral infections and cancer, including four clinical stage candidates and four preclinical candidates. YS Group expects PIKA rabies vaccine to lead and expedite its progress in the development and commercialization of existing pipeline products. YS Group believes that its accumulated experience and resources in vaccine sales, manufacture and commercialization will be a strong driving force for the market launch of PIKA rabies



vaccine and lay a solid foundation for YS Group's future expansion. For YS Group's other existing pipeline candidates, YS Group plans to strategically accelerate their development and commercialization based on its PIKA immunomodulating technology to realize YS Group's full potential in other important prophylactic and therapeutic areas.

***YS Group's ability to optimize its cost structure***

YS Group's results of operations are significantly affected by its costs and expenses. During the two fiscal years ended March 31, 2022 and the six months ended September 30, 2022, YS Group's results of operations were significantly affected by its research and development expenses, administrative expenses, and selling expenses and other expenses. YS Group expects that costs of sales and selling expenses will have a significant impact on its results of operations in the future as YS Group started to sell YSJA™ rabies vaccine in October 2020. YS Group also expects that its research and development expenses and administrative expenses, among others, will continue to have a significant impact on its financial performance.

Research and development activities are central to YS Group's business model. The development of YS Group's product candidates requires significant investment of resources over a prolonged period of time. YS Group has devoted significant resources to research and development activities. In the fiscal year ended March 31, 2022 and 2021, YS Group's research and development expenses were RMB211 million (\$33.2 million) and RMB93 million, respectively. For the six months ended September 30, 2022 and 2021, YS Group's research and development expenses were RMB123.9 million (\$17.4 million) and RMB124.1 million, respectively. YS Group's current research and development activities primarily relate to the clinical advancement of its product candidates. YS Group expects its research and development expenses to continue to increase for the foreseeable future as YS Group moves its product candidates, either from preclinical trials to clinical trials, or further into more advanced stages of clinical trials, and as YS Group continues to support the clinical trials of its product candidates as treatments for additional indications.

YS Group's administrative expenses primarily included employee benefits expenses primarily relating to salaries, share-based payment and other welfare for its administrative employees, depreciation and amortization expenses, and professional service fees. YS Group expects that its administrative expenses will increase as YS Group expands its operations to support its growing business.

As YS Group began the sales and marketing of its marketed product in October 2020 and has a robust pipeline of product candidates from preclinical to late-stage, YS Group intends to leverage its in-house commercialization team and external service providers to expand its sales network and anticipate that its selling expenses will increase in the future to support the implementation of its sales plan.

YS Group expects its cost structure to evolve as it continues to develop and expand its business. As the clinical trials of its product candidates continue to progress and as it gradually brings its product pipeline to commercialization, YS Group expects to incur additional costs in relation to raw materials procurement, manufacturing, sales and marketing, among other things. YS Group also anticipates increasing legal, compliance, accounting, insurance, and investor and public relations expenses associated with being a public company.

***YS Group's ability to maintain adequate funding for its operations***

YS Group has historically funded its operations primarily through private equity and debt financing. Going forward, in the event of a successful commercialization of one or more of its product candidates, YS Group expects to fund its operations in part with revenue generated from sales of its marketed product. However, with the continuing expansion of its business, YS Group may require further funding through public or private offerings, debt financing, collaboration and licensing arrangements or other sources. Any fluctuation in the funding for YS Group's operations will impact its cash flow plan and results of operations.

**Components of Results of Operations**

***Revenue***

YS Group primarily generates revenue from the sales of YSJA™ rabies vaccine. This revenue is generally recognized when YS Group provides rabies vaccine products to customers at a point in time when the products have been accepted by customers which is generally when YS Group satisfies the associated performance obligation.

***Cost of revenue***

YS Group's cost primarily consists of material, direct labor and production overheads. Depreciation of property, plant and equipment attributable to manufacturing activities and license amortization are capitalized as part of inventory and expensed as cost of revenue when product is sold. YS Group anticipates its direct costs associated with rabies vaccine will increase over the time mainly because the price of direct raw materials is rising.

***Gross profit, and gross margin***

YS Group's gross profit represents its total revenue less total cost of revenue, and its gross margin is its gross profit expressed as a percentage of its total revenue. YS Group expects its gross profit and gross margin to increase in the long term as YS Group achieves greater economies of scale through reducing direct costs as a percentage of revenue by expanding its manufacturing facilities.

***Operating expenses******Selling expenses***

Selling expenses primarily consisted of employee benefits expenses, travel and entertainment expenses and promotion and marketing service fees and other marketing expenses. Employee benefits expenses primarily included salaries, share-based payment and other welfare for YS Group's commercialization staff. Traveling and entertainment expenses primarily represented such expenses incurred by YS Group's commercialization staff in their sales activities. Promotion and marketing service fees primarily represented the costs YS Group incurred to engage marketing service providers for the commercialization of YSJA™ rabies vaccines.

***General and administrative expenses***

General and administrative expenses primarily consisted of employee benefits expenses, depreciation and amortization, allowance for trade receivables and inventories, professional service fees and other expense. Employee benefits expenses primarily included salaries, share-based payment and other welfare for YS Group's administrative staff. Depreciation and amortization primarily consisted of depreciation expenses for property, plant and equipment and right-of-use assets and amortization expenses for intangible assets used for administrative purpose.

***Research and development expenses***

Research and development expenses primarily consisted of employee benefits expenses, testing and clinical trial expenses, consulting service fees, depreciation and amortization, and office and leasing expenses and other expenses. Employee benefits expenses primarily included salaries, share-based payment and other welfare for YS Group's research and development employees. Testing and clinical trial expenses primarily represented costs YS Group incurred in conducting clinical trials for its product candidates, including in-house testing fees, purchase of raw materials and consumables, and engagement of clinical trial sites and principal investigators. Consulting service fees primarily represented third-party contracting costs with respect to the engagement of CROs and CRCs, and testing and processing services fees charged by such third parties. Depreciation and amortization primarily consisted of depreciation expenses for property, plant and equipment and amortization expenses for intangible assets used for research and development purpose.

***Income tax expense***

YS Group is subject to profit tax on an entity basis on profits arising in or sourced from the jurisdictions in which members of YS Group are domiciled and operate.

***Cayman Islands.*** Under the current laws of the Cayman Islands, YS Group is not subject to tax on income or capital gains. In addition, upon payments of dividends by YS Biopharma to its shareholders, no Cayman Islands withholding tax is imposed.

***Hong Kong.*** Under the Hong Kong tax laws, Yisheng Hong Kong is exempted from profit tax on its foreign-sourced income and there are no withholding taxes in Hong Kong on remittance of dividends.

Singapore. The subsidiary incorporated in Singapore files separate income tax returns in Singapore at Singapore statutory income tax rate of 17%.

China. Under the Enterprise Income Tax (“EIT”) Law of the PRC, domestic enterprises and Foreign Investment Enterprises (the “FIE”) are usually subject to a unified 25% EIT rate while preferential tax rates, tax holidays, and even tax exemption may be granted on case-by-case basis. The PRC tax authorities grant preferential tax treatment to High and New Technology Enterprises (“HNTEs”). Under this preferential tax treatment, HNTEs are entitled to an income tax rate of 15%, subject to a requirement that they re-apply for HNTE status every three years. Since Liaoning Yisheng was approved as an HNTE in December 2021, Liaoning Yisheng is entitled to a reduced income tax rate of 15% and is able to enjoy the reduced income tax rate in the next three years. Beijing yisheng is subject to corporate income tax at a statutory rate of 25% on the taxable income.

United States. The subsidiary incorporated in Maryland, United States was subject to statutory United States federal corporate income tax at a rate of 21% and state income tax in Maryland at a rate of 8.25% during the reported fiscal periods.

## Results of Operations

The following table summarizes the results of YS Group’s operations for the period as indicated and provides information regarding the percentage increase or (decrease) during such periods. This information should be read together with YS Group’s condensed consolidated financial statements and related notes included elsewhere in this prospectus. The operating results in any period are not necessarily of the results that may be expected for any future period.

	For the Six Months Ended September 30,						For the Fiscal Years Ended March 31,							
	2022		2021		Variance		2022		2021		Variance			
	RMB	\$	%	RMB	%	RMB	%	RMB	\$	%	RMB	%		
Revenues	399,534,723	56,274,081	100.0	269,433,426	100.0	130,101,297	48.3	502,949,894	79,227,166	100.0	257,015,929	100.0	245,933,965	95.7
Cost of revenues	93,700,779	13,197,665	100.0	63,599,621	100.0	30,101,158	47.3	117,066,090	18,440,832	100.0	59,656,877	100.0	57,409,213	96.2
Gross profit	305,833,944	43,076,416	76.5	205,833,805	76.4	100,000,139	48.6	385,883,804	60,786,334	76.7	197,359,052	76.8	188,524,752	95.5
Operating expenses:														
Selling expenses	150,228,079	21,159,480	46.4	86,265,281	32.9	63,962,798	74.1	185,999,704	29,299,597	36.8	73,485,259	22.7	112,514,445	153.1
General and administrative expenses	49,587,013	6,984,283	15.3	51,664,591	19.7	(2,077,578)	(4.0)	107,620,500	16,952,916	21.3	155,334,386	48.1	(47,713,886)	(30.7)
Research and development expenses	123,861,107	17,445,718	38.3	124,051,209	47.4	(190,102)	(0.2)	211,222,263	33,272,780	41.9	94,387,144	29.2	116,835,119	123.8
Total operating expenses	323,676,199	45,589,481	100.0	261,981,081	100.0	61,695,118	23.5	504,842,467	79,525,293	100.0	323,206,789	100.0	181,635,678	56.2
Loss from operations	(17,842,255)	(2,513,065)	(4.5)	(56,147,276)	(20.8)	38,305,021	(68.2)	(118,958,663)	(18,738,959)	(23.7)	(125,847,737)	(49.0)	6,889,074	(5.5)
Other income (expenses):														
Late fees related to income tax	—	—	—	—	—	—	—	—	—	—	(11,464,741)	23.6	11,464,741	(100.0)
Late fees related to tax other than income tax	—	—	—	(112,420)	(0.7)	112,420	(100.0)	(231,231)	(36,425)	(1.3)	(7,261,947)	15.0	7,030,716	(96.8)
Late fees related to social insurance	(299,417)	(42,173)	(4.1)	(1,396,221)	(8.3)	1,096,804	(78.6)	(1,852,378)	(291,796)	(10.4)	(7,701,793)	15.9	5,849,415	(75.9)
Government grants	22,456,691	3,163,003	308.4	19,600,822	117.1	2,855,869	14.6	23,020,413	3,626,290	128.7	3,530,405	(7.3)	19,490,008	552.1
Financial expense, net	(14,949,434)	(2,105,613)	(205.3)	(352,694)	(2.2)	(14,596,740)	4,138.6	(2,717,433)	(428,064)	(15.2)	(29,689,927)	61.2	26,972,494	(90.8)
Other income, net	74,675	10,518	1.0	(993,957)	(5.9)	1,068,632	(107.5)	(327,987)	(51,666)	(1.8)	4,063,743	(8.4)	(4,391,730)	(108.1)
Total other income, net	7,282,515	1,025,735	100.0	16,745,530	100.0	(9,463,015)	(56.5)	17,891,384	2,818,339	100.0	(48,524,260)	100.0	66,415,644	(136.9)
Loss before income taxes	(10,559,740)	(1,487,330)	(2.6)	(39,401,746)	(14.6)	28,842,006	(73.2)	(101,067,279)	(15,920,620)	(20.1)	(174,371,997)	(67.8)	73,304,718	(42.0)
Provision for income taxes	(565,625)	(79,668)	(0.1)	(5,689,586)	(2.1)	5,123,961	(90.1)	(4,937,122)	(777,720)	(1.0)	(17,454,245)	(6.8)	12,517,123	(71.7)
Net loss	(11,125,365)	(1,566,998)	(2.7)	(45,091,332)	(16.7)	33,965,967	(75.3)	(106,004,401)	(16,698,340)	(21.1)	(191,826,242)	(74.6)	85,821,841	(44.7)

### Six months ended September 30, 2022 compared to six months ended September 30, 2021.

#### Revenue

YS Group’s revenue increased by RMB130.1 million, or 48.3%, from RMB269.4 million for the six months ended September 30, 2021 to RMB399.5 million (\$56.3 million) for the six months ended September 30, 2022. The increase was due primarily to (i) the increase in the sales volume of YSJATM rabies vaccine products by 46%, which was mainly due to the expansion of district and county CDC access and hospital access in

promoting and marketing services and the increased of market acceptance of the product; (ii) the increase in the product price by approximately RMB1 per dose compared with the same period in 2021.

#### ***Cost of revenue***

YS Group's cost of revenue increased by RMB30.1 million, or 47.3%, from RMB63.6 million for the six months ended September 30, 2021 to RMB93.7 million (\$13.2 million) for the six months ended September 30, 2022. The increase in costs was attributable primarily to the increase in sales volume of YSJA™ rabies vaccine products.

#### ***Gross profit and gross margin***

As a result of the foregoing, YS Group's gross profit increased by RMB100 million, or 48.6%, from RMB205.8 million for the six months ended September 30, 2021 to RMB305.8 million (\$43.1 million) for the six months ended September 30, 2022.

YS Group's margin was stable during these two periods.

#### ***Selling expenses***

Selling expenses increased by RMB64.0 million, or 74.1%, from RMB86.3 million for the six months ended September 30, 2021 to RMB150.2 million (\$21.2 million) for the six months ended September 30, 2022. The increase in selling expenses was primarily due to an increase of RMB3.7 million in staff costs as a result of the increase in the headcount in sales department and an increase of RMB60.3 million in promoting and marketing service fees in order to expand the access to district and county CDCs and hospitals.

The following table sets forth a breakdown of YS Group's selling expenses in absolute amount and as a percentage of the total selling expenses for the periods indicated.

	For the Six Months Ended September 30,					
	2022		2021		Variance	
	RMB	%	RMB	%	RMB	%
Promoting and marketing service fees	138,166,922	92.0	77,896,957	90.3	60,269,965	77.4
Employee benefits expenses	11,086,976	7.4	7,426,168	8.6	3,660,808	49.3
Others	974,181	0.6	942,156	1.1	32,025	3.4
Total	150,228,079	100	86,265,281	100	63,962,798	74.1

#### ***General and administrative expenses***

General and administrative expenses decreased from RMB51.7 million for the six months ended September 30, 2021 to RMB49.6 million (\$7.0 million) for the six months ended September 30, 2022, primarily due to decrease of RMB10.5 million in professional service fees, partially offset by (i) an increase of RMB3.2 million in allowance for trade receivables and inventories due to the increase in accounts receivable, (ii) an increase of RMB3.5 million in bank charges and exchange difference due to exchange rate changes, (iii) an increase of RMB1.9 million in employee benefits expenses due to the increase in headcount.

YS Group's bad debt expenses was RMB6,447,110 for the six months ended September 30, 2022, representing an increase of RMB3.6 million or 123.2%, from RMB 2,888,417 for the same period in 2021. Bad debt expenses are determined based on individual account analysis, historical collection trend, and best estimate of specific losses on individual exposures. YS Group deemed accounts receivables and other receivables as uncollectible after all means of collection have been exhausted and the likelihood of collection is not probable.

From October 1, 2022 to December 26, 2022, the subsequent settlement of YS Group's accounts receivable as of September 30, 2022 is shown in the following table:

Six Months Ended September 30,	0–90 days	90–180 days	180–365 days	>365 days	Total
2022 (RMB)	45,909,832	50,517,783	29,990,148	11,328,780	137,746,543
2022 (USD)	\$ 6,466,356	\$ 7,115,381	\$ 4,224,083	\$ 1,595,648	\$ 19,401,468

As of the date of this proxy statement/prospectus, YS Group has collected approximately RMB137.7 million or 28% of its accounts receivable as of September 30, 2022. YS Group is not aware of any collection risk on the remaining balance.

YS Group's trading terms with its customers are mainly on a 120-days contracted credit term. In practice, the credit term is normally 180 to 360 days.

The days sales outstanding were 217 days and 224 days for the six months ended September 30, 2021 and the six months ended September 30, 2022, respectively.

The following table sets forth a breakdown of YS Group's general and administrative expenses in absolute amount and as a percentage of the total general and administrative expense for the periods indicated.

	For the Six Months Ended September 30,					
	2022		2021		Variance	
	RMB	%	RMB	%	RMB	%
Employee benefits expenses	20,634,246	41.6	18,778,964	36.3	1,855,282	9.9
Depreciation and amortization expenses	3,500,469	7.1	3,085,724	6.0	414,745	13.4
Professional service fees	5,048,114	10.2	15,508,682	30.0	(10,460,568)	(67.4)
Office expenses	1,329,449	2.7	1,019,819	2.0	309,630	30.4
Allowance for trade receivables	6,447,110	13.0	2,888,417	5.6	3,558,693	123.2
Allowance for obsolete inventories	(323,492)	(0.7)	—	—	(323,492)	(100.0)
Taxes and surcharges	3,196,939	6.4	3,065,689	5.9	131,250	4.3
Bank charges and exchange difference	5,120,896	10.3	1,636,971	3.2	3,483,925	212.8
Others	4,633,282	9.3	5,680,325	11.0	(1,047,043)	(18.4)
<b>Total</b>	<b>49,587,013</b>	<b>100.0</b>	<b>51,664,591</b>	<b>100.0</b>	<b>(2,077,578)</b>	<b>(4.0)</b>

#### **Research and development expenses**

Research and development expenses decreased by RMB0.2 million, or 0.2%, from RMB124.1 million for the six months ended September 30, 2021 to RMB123.9 million (\$17.4million) for the six months ended September 30, 2022. The decrease in research and development expenses was primarily attributable to the decrease of RMB33.1 million in consulting service fees since the development of COVID-19 vaccines entered the clinical trial stage, partially offset by (i) an increase of RMB21.3 million in testing and clinical trial fees relating to the research of PIKA rabies vaccine and COVID-19, and (ii) an increase of RMB9.2 million of employee benefit expenses driven by significant growth in its research and development headcount to support the growth and development of its pipeline.

The following table sets forth a breakdown of YS Group's research and development expenses in absolute amount and as a percentage of the total research and development expenses for the periods indicated.

	For the Six Months Ended September 30,					
	2022		2021		Variance	
	RMB	%	RMB	%	RMB	%
Testing and clinical trial fees	69,020,560	55.7	47,673,861	38.4	21,346,699	44.8
Consulting service fees	8,411,505	6.8	41,536,873	33.5	(33,125,368)	(79.7)
Employee benefits expenses	33,812,314	27.3	24,577,264	19.8	9,235,050	37.6
Depreciation and Amortization expenses	6,323,641	5.1	4,934,566	4.0	1,389,075	28.1
Office and leasing expenses	588,586	0.5	565,381	0.5	23,205	4.1
Others	5,704,501	4.6	4,763,264	3.8	941,237	19.8
<b>Total</b>	<b>123,861,107</b>	<b>100.0</b>	<b>124,051,209</b>	<b>100.0</b>	<b>(190,102)</b>	<b>(0.2)</b>

The following table below sets forth a breakdown of YS Group's key research and development projects.

	For the Six Months Ended September 30,					
	2022		2021		Variance	
	RMB	%	RMB	%	RMB	%
PIKA Recombinant COVID-19 vaccine	82,214,199	66.4	80,241,252	64.7	1,972,947	2.5
PIKA rabies vaccine	17,519,659	14.1	8,965,209	7.2	8,554,450	95.4
PIKA YS-0N-001	4,854,187	3.9	10,982,320	8.9	(6,128,133)	(55.8)
PIKA HBV vaccines	5,940,696	4.8	9,007,328	7.3	(3,066,632)	(34.0)
PIKA adjuvant	4,054,248	3.3	4,344,773	3.5	(290,525)	(6.7)
YSJA™ rabies vaccine	4,275,750	3.5	5,221,734	4.2	(945,984)	(18.1)
Others	5,002,368	4.0	5,288,593	4.2	(286,225)	(5.4)
<b>Total</b>	<b>123,861,107</b>	<b>100.0</b>	<b>124,051,209</b>	<b>100.0</b>	<b>(190,102)</b>	<b>(0.2)</b>

#### *Other income (expenses)*

Other income (expenses) decreased by RMB9.5 million, or 56.5%, from other income RMB16.7 million for the six months ended September 30, 2021 to other income RMB7.3 million (\$1.0 million) for the six months ended September 30, 2022. The increase in non-operating income was primarily attributable to an increase of RMB2.9 million in government grants and a decrease of RMB1.2 million in late fee charge of social insurance and tax other than income tax, and an increase of RMB14.6 million in financial expenses, which was primarily attributable to (i) an increase of RMB11.4 million in interest expense and royalty fee under the Facility Agreement; and (ii) an increase of RMB2.6 million in interest expense on bank loans, since YS Group drew down approximately RMB103 million bank loan from April to September 2022, with the weighted average interest rate of borrowings as end-of-period 5.01%.

#### *Income tax expense*

YS Biopharma's PRC subsidiaries are subject to income taxes in China on their taxable income calculated at a tax rate in accordance with the relevant income tax laws and regulations. YS Group determine deferred taxes for each tax-paying entity in each tax jurisdiction. The potential tax benefits arising from the losses incurred by the subsidiaries have been recorded in its financial statements. YS Group's income tax expense decreased from RMB5.7 million in the six months ended September 30, 2021 to RMB0.6 million (\$0.1 million) in the six months ended September 30, 2022, primarily due to decrease in deferred tax assets of disposing inventories that have been impaired in the previous period.

YS Group evaluate its valuation allowances requirements at each reporting period by reviewing all available evidence, both positive and negative, and considering whether, based on the weight of that evidence, a valuation allowance is needed. When a change in circumstances causes a change in management's judgment about the ability to realize deferred tax assets, the impact of the change on the valuation allowance is generally reflected in income from operations. The future realization of the tax benefit of an existing deductible temporary difference ultimately depends on the existence of sufficient taxable income of the appropriate character within the carry forward period available under applicable tax law.

#### *Net loss*

As a result of the foregoing, YS Group recognized a loss of RMB11.1 million (\$1.6 million) and RMB45.1 million for the six months ended September 30, 2022 and 2021, respectively.

#### **Fiscal year ended March 31, 2022 compared to fiscal year ended March 31, 2021.**

#### *Revenue*

YS Group's revenue increased by RMB245.9 million, or 95.7%, from RMB257.0 million for the fiscal year ended March 31, 2021 to RMB502.9 million (\$79.2 million) for the fiscal year ended March 31, 2022. The increase was due primarily to the facts that (i) the sales period is approximately six months in 2021 fiscal year,

as YS Group started selling the YSJA™ rabies vaccine products since October 2020; and (ii) the product price increased by approximately RMB2 per dose in 2022 fiscal year.

#### *Cost of revenue*

YS Group's cost of revenue primarily consisted of raw material costs, staff costs, manufacturing costs and depreciation expenses. The cost increased by RMB57.4 million, or 96.2%, from RMB59.7 million for the fiscal year ended March 31, 2021 to RMB117.1 million (\$18.4 million) for the fiscal year ended March 31, 2022. The increase in costs was attributable primarily to the increase in sales volume of YSJA™ rabies vaccine products.

#### *Gross profit and gross margin*

YS Group's gross profit increased by RMB188.5 million, or 95.5%, from RMB197.4 million for the fiscal year ended March 31, 2021 to RMB385.9 million (\$60.8 million) for the fiscal year ended March 31, 2022. The increase in gross profit was primarily due to the increase in revenue. YS Group's gross margin was stable for the fiscal years ended March 31, 2022 and 2021.

#### *Selling expenses*

Selling expenses increased by RMB112.6 million, or 153.1%, from RMB73.5 million for the fiscal year ended March 31, 2021 to RMB186.0 million (\$29.3 million) for the fiscal year ended March 31, 2022. The increase in selling expenses was primarily due to an increase of RMB16.2 million in staff costs and RMB97.7 million in promoting and marketing service fees related to the commercialization of YSJA™ rabies vaccine.

The following table sets forth a breakdown of YS Group's selling expenses in absolute amount and as a percentage of the total selling expenses for the periods indicated.

	For the Fiscal Years Ended March 31,					
	2022		2021		Variance	
	RMB	%	RMB	%	RMB	%
Promoting and marketing service fees	162,461,330	87.3	64,770,329	88.1	97,691,001	150.8
Employee benefits expenses	20,283,326	10.9	4,049,357	5.5	16,233,969	400.9
Others	3,255,048	1.8	4,665,573	6.4	(1,410,525)	(30.2)
<b>Total</b>	<b>185,999,704</b>	<b>100.0</b>	<b>73,485,259</b>	<b>100.0</b>	<b>112,514,445</b>	<b>153.1</b>

#### *General and administrative expenses*

General and administrative expenses decreased from RMB155.3 million for the fiscal year ended March 31, 2021 to RMB107.6 million (\$17.0 million) for the fiscal year ended March 31, 2022, primarily due to decrease of RMB64.4 million in share-based compensation expenses, as most of YS Group's options had been vested before March 31, 2021, which was partially offset by an increase of RMB16.1 million in staff cost.

YS Group's bad debt expenses was RMB5,082,725 for the fiscal year ended March 31, 2022, a decrease of RMB1,916,093 or 27.4%, from RMB6,998,818 for the same period in 2021. Bad debt expenses are determined based on individual account analysis, historical collection trend, and best estimate of specific losses on individual exposures. YS Group deemed accounts receivables and other receivables as uncollectible after all means of collection have been exhausted and the likelihood of collection is not probable.

From April 1, 2022 to September 27, 2022, being the date of the auditors' opinion on YS Group's financial statement for the two fiscal years ended March 31, 2022, the subsequent settlement of YS Group's accounts receivable as of March 31, 2022 is shown in the following table:

Fiscal Year Ended March 31,	0-90 days	90-180 days	180-365 days	>365 days	Total
2022 (RMB)	73,593,680	64,397,895	58,064,055	7,184,920	203,240,550
2022 (USD)	\$11,592,842	\$10,144,276	\$ 9,146,538	\$1,131,804	\$ 32,015,460

As of September 27, 2022, YS Group had collected approximately RMB 203 million or 63% of its accounts receivable as of March 31, 2022. YS Group is not aware of any collection risk on the remaining balance.

YS Group's trading terms with its customers are mainly on a 120-days contracted credit term. In practice, the credit term is normally 180 to 360 days.

The days sales outstanding decreased by 83 days, or 26.2%, from 317 days for the fiscal year ended March 31, 2021 to 234 days for the fiscal year ended March 31, 2022. The decrease in days sales outstanding was primarily due to the fact that the sales period is approximately six months in 2021 fiscal year as YS Group started selling the YSJA rabies vaccine products since October 2020.

The following table sets forth a breakdown of YS Group's general and administrative expenses in absolute amount and as a percentage of the total general and administrative expense for the periods indicated.

	For the Fiscal Years Ended March 31,					
	2022		2021		Variance	
	RMB	%	RMB	%	RMB	%
Employee benefits expenses	41,599,522	38.7	89,872,239	57.9	(48,272,717)	(53.7)
Depreciation and Amortization expenses	5,998,308	5.6	9,489,983	6.1	(3,491,675)	(36.8)
Professional service fees	30,680,853	28.5	33,649,233	21.7	(2,968,380)	(8.8)
Office expenses	2,766,021	2.6	4,020,338	2.6	(1,254,317)	(31.2)
Allowance for trade receivables	5,082,725	4.7	6,998,818	4.5	(1,916,093)	(27.4)
Allowance for obsolete inventories	4,393,629	4.1	—	—	4,393,629	100.0
Taxes and surcharges	5,379,934	5.0	4,004,265	2.6	1,375,669	34.4
Others	11,719,508	10.8	7,299,510	4.6	4,419,998	60.4
<b>Total</b>	<b>107,620,500</b>	<b>100.0</b>	<b>155,334,386</b>	<b>100</b>	<b>(47,713,886)</b>	<b>(30.7)</b>

#### *Research and development expenses*

Research and development expenses increased by RMB116.8 million, or 123.8%, from RMB94.4 million for the fiscal year ended March 31, 2021 to RMB211.2 million (\$33.3 million) for the fiscal year ended March 31, 2022. The increase in research and development expenses was primarily attributable to (i) an increase of RMB27.3 million in employee related expenses driven by significant growth in YS Group's research and development headcount to support the growth and development of its pipeline; (ii) an increase of RMB53.7 million in preclinical and clinical development costs associated with COVID-19 vaccines, rabies vaccines and anticancer vaccines; (iii) an increase of RMB28.5 million in consulting and professional fees relating to the research of COVID-19; and (iv) an increase of RMB4.5 million in depreciation expenses for property, plant and equipment and amortization expenses for intangible assets used for research and development purpose.

The following table sets forth a breakdown of YS Group's research and development expenses in absolute amount and as a percentage of the total research and development expenses for the periods indicated.

	For the Fiscal Years Ended March 31,					
	2022		2021		Variance	
	RMB	%	RMB	%	RMB	%
Testing and clinical trial fees	74,166,285	35.1	20,480,320	21.7	53,685,965	262.1
Consulting service fees	59,975,917	28.4	31,492,876	33.4	28,483,041	90.4
Employee benefits expenses	56,513,100	26.8	29,178,337	30.9	27,334,763	93.7
Depreciation and amortization	10,796,480	5.1	6,331,638	6.7	4,464,842	70.5
Office and leasing expenses	1,039,327	0.5	3,446,146	3.7	(2,406,819)	(69.8)
Others	8,731,154	4.1	3,457,827	3.6	5,273,327	152.5
<b>Total</b>	<b>211,222,263</b>	<b>100.0</b>	<b>94,387,144</b>	<b>100.0</b>	<b>116,835,119</b>	<b>123.8</b>



The following table below sets forth a breakdown of YS Group's key research and development projects.

	For the Fiscal Years Ended March 31,					
	2022		2021		Variance	
	RMB	%	RMB	%	RMB	%
PIKA Recombinant COVID-19 vaccine	127,773,439	60.5	33,903,400	35.9	93,870,039	276.9
PIKA rabies vaccine	24,272,368	11.5	13,718,774	14.5	10,553,594	76.9
PIKA YS-0N-001	16,528,066	7.8	4,312,590	4.6	12,215,476	283.3
PIKA HBV vaccines	16,438,478	7.8	7,536,556	8.0	8,901,922	118.1
PIKA adjuvant	8,171,893	3.9	26,036,582	27.6	(17,864,689)	(68.6)
YSJA-TM rabies vaccine	7,579,877	3.6	3,939,781	4.2	3,640,096	92.4
Others	10,458,142	4.9	4,939,461	5.2	5,518,681	111.7
<b>Total</b>	<b>211,222,263</b>	<b>100.0</b>	<b>94,387,144</b>	<b>100.0</b>	<b>116,835,119</b>	<b>123.8</b>

#### *Other income (expenses)*

Other income (expenses) increased by RMB66.4 million, or 136.9%, from other expense RMB48.5 million for the fiscal year ended March 31, 2021 to other income, net RMB17.9 million (\$2.8 million) for the fiscal year ended March 31, 2022. The increase in non-operating income was primarily attributable to (1) a decrease of RMB24.34 million in late fee charge of social insurance and tax; and (2) an increase of RMB19.5 million in government grants, which was partially offset by a decrease of RMB4.4 million in other income; (3) an decrease of RMB5.0 million in financial expense which was primarily attributable to (i) a decrease of RMB3.0 million in interest expense on bank loans, as interest rate on bank loans decreased from 8% and 8.0475% per annum in the fiscal year ended March 31, 2022 to 5.3% and 5.655% per annum in the fiscal year ended March 31, 2022 and repayment by YS Group of RMB49.6 million in bank loan in the fiscal year ended March 31, 2022; (ii) a decrease of RMB2.0 million in interest expense on borrowings from YS Group's employees; and (iii) a decrease of RMB22.0 million in the transaction cost for issuance of convertible notes and preferred shares in the fiscal year ended March 31, 2021.

#### *Income tax expense*

YS Group's PRC subsidiaries are subject to income taxes in China on their taxable income calculated at a tax rate in accordance with the relevant income tax laws and regulations. YS Group determines deferred taxes for each tax-paying entity in each tax jurisdiction. The potential tax benefits arising from the losses incurred by the subsidiaries have been recorded in YS Group's financial statements. YS Group's income tax expense decreased from RMB17.5 million in the fiscal year ended March 31, 2021 to RMB4.9 million (\$0.8 million) in the fiscal year ended March 31, 2022, primarily due to the decrease in deferred tax assets from disposing of inventories that have been impaired in the previous period.

YS Group evaluates its valuation allowances requirements at each reporting period by reviewing all available evidence, both positive and negative, and considering whether, based on the weight of that evidence, a valuation allowance is needed. When a change in circumstances causes a change in management's judgment about the ability to realize deferred tax assets, the impact of the change on the valuation allowance is generally reflected in income from operations. The future realization of the tax benefit of an existing deductible temporary difference ultimately depends on the existence of sufficient taxable income of the appropriate character within the carry forward period available under applicable tax law.

#### *Net loss*

As a result of the foregoing, YS Group recognized a loss of RMB106.0 million (\$16.7 million) and RMB191.8 million for the fiscal years ended March 31, 2022 and 2021, respectively.

## Liquidity and Capital Resources

The following table sets forth a summary of YS Group's cash flows for the periods indicated.

	For the Six Months Ended September 30,			For the Fiscal Years Ended March 31,		
	2022		2021	2022		2021
	RMB	\$	RMB	RMB	\$	RMB
Net cash used in operating activities	(107,395,153)	(15,126,504)	(176,984,374)	(173,545,357)	(27,337,727)	(246,610,437)
Net cash used in investing activities	(19,024,351)	(2,679,561)	(203,390,377)	(298,923,958)	(47,087,987)	(104,238,941)
Net cash provided by financing activities	51,907,325	7,311,097	43,885,865	364,558,145	57,427,010	739,258,696
Effect of foreign exchange rate on cash and cash equivalents	30,471,942	4,291,943	(4,446,301)	(11,478,411)	(1,808,136)	(2,674)
Net decrease in cash and cash equivalents	(44,040,237)	(6,203,025)	(340,935,187)	(119,389,581)	(18,806,840)	388,406,644
Cash and restricted cash at the beginning of the fiscal year	271,067,503	38,179,597	390,457,084	390,457,084	61,506,740	2,050,440
Cash and restricted cash at the end of the fiscal year	227,027,266	31,976,572	49,521,897	271,067,503	42,699,900	390,457,084

YS Group has historically financed its operations primarily through issuance of ordinary and preferred shares, issuance of convertible securities and cash generated from sales of its vaccines. YS Group's primary requirements for liquidity and capital are to finance working capital, capital expenditures and general corporate purposes as well as investment in research and development and potential mergers and acquisition opportunities.

As of September 30, 2022, YS Group's principal source of liquidity was its cash and restricted cash balance of RMB227.0 million (\$32.0 million), which was held for working capital purposes. YS Group incurred a net loss after tax of RMB11.1 million (\$1.6 million) for the six months ended September 30, 2022. As of March 31, 2022 and 2021, YS Group's principal source of liquidity was its cash balance of RMB271.1 million (\$42.7 million) and RMB390.5 million, respectively, which was held for working capital purposes. YS Group incurred a net loss after tax of RMB106.0 million (\$16.7 million) and RMB191.8 million for the fiscal years ended March 31, 2022 and 2021, respectively.

YS Group's primary uses of cash are to fund the development of its product candidates, its clinical trials, its construction of research and manufacturing facilities, purchase of equipment, compensation of key personnel, administrative expenses and other recurring expenses. YS Group's net cash used in operating activities was RMB107.4 million (\$15.1 million), RMB173.5 million (\$27.3 million) and RMB246.6 million in the six months ended September 30, 2022 and in the fiscal years ended March 31, 2022 and 2021, respectively, primarily due to the significant research and development expenses and administrative expenses. YS Group's operating cash flow will continue to be affected by its research and development expenses, in particular clinical trial fees for its product candidates. YS Group has historically primarily funded its working capital requirements through proceeds from equity and debt financing. YS Group's management closely monitors uses of cash and cash balances and strives to maintain a healthy liquidity for its operations. Going forward, YS Group believes its liquidity requirements will be satisfied by a combination with Summit was and cash generated from its operations. As of September 30, 2022 and March 31, 2022 and 2021, YS Group's working capital was RMB296.2 million (\$41.7 million), RMB288.9 million (\$45.5 million) and RMB388.2 million, respectively.

### *Operating activities*

Cash flows from operating activities represent the cash receipts and disbursements related to YS Group's all activities other than investing and financing activities. Operating cash flow is derived by adjusting YS Group's net loss for non-cash operating items such as depreciation, and stock-based compensation, as well as changes in operating assets and liabilities, which reflect timing differences between the receipt and payment of cash associated with transactions and when they are recognized in YS Group's results of operations.

Net cash used in operating activities of RMB107.4 million (\$15.1 million) for the six months ended September 30, 2022 was primarily related to a net loss for the period of RMB11.1 million (\$1.6 million) adjusted for certain non-cash items, which included Deferred income taxes RMB0.6 million (\$0.1 million), depreciation of RMB13.8 million (\$1.9 million), amortization of intangible assets of RMB3.4 million (\$0.5 million), impairment of accounts receivable of RMB6.4 million (\$0.9 million), and non-cash lease expense of RMB2.4 million (\$0.3 million). The net changes in operating assets and liabilities of RMB122.9 million were primarily related to an decrease in inventories of RMB4.8 million due to decrease in raw materials and finished products as the sales volume has increased, an increase in trade receivables of RMB166.3 million from increased sales of the rabies vaccine during the period, a decrease in prepaid expenses and other current assets of RMB4.1 million due primarily to decreased in advance to supplier, an increase in trade payables of RMB6.5 million as a result of extending the accounting period for customers, and an increase in accrued expenses and current liabilities of RMB37.3 million due to increased expenditure on CDC transportation and storage fee and promotion service fee, a decrease in deferred government grant of RMB8.0 million due to recognized in income as the conditions are met, and a decrease in payment of lease liabilities of RMB1.4 million.

Net cash used in operating activities of RMB173.5 million (\$27.3 million) for the fiscal year ended March 31, 2022 was primarily related to a net loss for the fiscal year of RMB106 million (\$16.7 million) adjusted for certain non-cash items, which included Deferred income taxes RMB4.9 million (\$0.8 million), depreciation of RMB24.5 million (\$3.9 million), amortization of intangible assets of RMB6.7 million (\$1.1 million), loss on disposal of property, plant and equipment of RMB0.3 million (\$0.04 million), share-based compensation expense of RMB7.8 million (\$1.2 million), impairment of trade receivable and inventories of RMB5.1 million (\$0.8 million), write-down of inventories to net realizable value of RMB4.4 million (\$0.7 million), and non-cash lease expense of RMB3.8 million (\$0.6 million). The net changes in operating assets and liabilities of RMB124.9 million were primarily related to an increase in inventories of RMB89.5 million due to increased demand in rabies vaccine and YS Group's decision to continue to increase its inventory level to avoid any unpredictable logistics disruption or rising cost of raw material from the ongoing impact of COVID-19 on the global supply chain, an increase in trade receivables of RMB99.1 million from increased sales of the rabies vaccine in 2022 fiscal year, a decrease in amounts due from related parties of RMB30.1 million, a decrease in prepaid expenses and other current assets of RMB59.2 million due primarily to increased prepayments for construction in progress, an increase in trade payables of RMB14.4 million as a result of extending the accounting period for customers, which were partially offset by a decrease in accrued expenses and current liabilities of RMB35.6 million due to decrease expenditure on staff costs and increase expenditure for construction in progress, decrease in deferred government grant of RMB0.7 million, and payment of lease liabilities of RMB3.8 million.

Net cash used in operating activities of RMB246.6 million for the fiscal year ended March 31, 2021 was primarily related to a loss before tax for the year of RMB191.8 million, adjusted for certain non-cash items, which included deferred income tax of RMB17.5 million, depreciation of RMB22.2 million, amortization of intangible assets of RMB5.7 million, share-based compensation expense of RMB76.8 million, impairment of trade receivable of RMB6.4 million, write-down of inventories to net realizable value RMB1.1 million, and non-cash lease liability of RMB2.2 million. The net changes in operating assets and liabilities of RMB186.7 million were primarily related to an increase in inventories of RMB68.7 million due to increased demand in rabies vaccine and YS Group's decision to continue to increase its inventory level to avoid any unpredictable logistics disruption or rising cost of raw material from the ongoing impact of COVID-19 on the global supply chain, an increase in trade receivables of RMB220.7 million from increased sales of the rabies vaccine in 2021 fiscal year, an increase in amounts due from related parties of RMB3.1 million, an increase in prepaid expenses and other current assets of RMB146.8 million primarily due to increase in advance to suppliers, a decrease in trade payables of RMB4.4 million, payment of income tax for previous years of RMB34.1 million, and payment of lease liabilities of RMB2.2 million.

### ***Investing activities***

Cash flows used in investing activities primarily relate to purchase of property, plant and equipment, acquisition of a subsidiary (net of cash acquired), investment in joint ventures as well as purchase of intangible assets.

Net cash used in investing activities was RMB19.0 million (\$2.7 million) for the six months ended September 30, 2022 which consisted primarily of payment for purchase of items of property, plant and equipment of RMB15.0 million (\$2.1 million) and payment for purchase of intangible assets of RMB4.0 million (\$0.6 million) partially.

Net cash used in investing activities was RMB298.9 million (\$47.1 million) for the fiscal year ended March 31, 2022, which consisted primarily of payment for purchase of items of property, plant and equipment of RMB295.3 million (\$46.5 million) and partial payment for purchase of intangible assets of RMB3.6 million (\$0.6 million).

Net cash used in investing activities was RMB104.2 million for the fiscal year ended March 31, 2021, which consisted primarily of payment for purchase of items of property, plant and equipment of RMB104.9 million, partially offset by a cash inflow from proceeds from disposal of property, plant and equipment of RMB0.6 million.

#### ***Financing activities***

Net cash generated from financing activities was RMB51.9 million (\$7.3 million) for the six months ended September 30, 2022, which consisted primarily of RMB102.5 million (\$14.4 million) in proceeds from bank and other borrowings, partially offset by RMB50.6 million (\$7.1 million) in repayment of bank.

Net cash generated from financing activities was RMB364.6 million (\$57.4 million) for the fiscal year ended March 31, 2022, which consisted primarily of RMB414.1 million (\$65.2 million) in proceeds from bank and other borrowings, partially offset by RMB49.6 million (\$7.8 million) in repayment of bank.

Net cash generated from financing activities was RMB739.3 million for the fiscal year ended March 31, 2021, which consisted primarily of RMB729.4 million in proceeds from issuance of mezzanine equity, RMB32.3 million in proceeds from bank and other borrowings, and RMB299.8 million in proceeds of loans from related parties, partially offset by RMB160.4 million in repayment of bank and other borrowings, RMB163.3 million in repayment of related parties, and RMB1.6 million in shareholders' contributions .

#### **Contractual Obligations**

On May 2, 2020, YS Group borrowed RMB1,103,609 (\$166,400) with an interest at 1.00% from Citi Bank. The loan was due on May 1, 2022. Before March 31, 2022, YS Group repaid approximately RMB869,000 (\$129,422). The balance of approximately RMB234,742 (\$36,978) was repaid in full in May 2022.

On March 5, 2021, YS Group entered into a credit facility of RMB 250 million with China CITIC Bank for three years to finance its working capital requirements. On September 7, 2021, YS Group entered into another credit facility of RMB250 million with China CITIC Bank for three years to finance its working capital requirements. YS Group has not drawn any amounts from these two facilities as of date of this report. These two credit facilities are due to expire on March 4, 2024 and September 6, 2024, respectively.

On April 13, 2022, YS Group entered into credit facility of RMB 70 million with China Everbright Bank for one year to finance its working capital requirements. YS Group has not drawn any amounts from this facility as of date of this proxy statement/prospectus. The credit facility is due to expire on April 13, 2023.

On July 12, 2021, YS Group entered into a credit facility of RMB140 million with Shanghai Pudong Development Bank Co., Ltd. Shenyang Branch for three years to finance its working capital requirements. YS Group drew down approximately RMB64.6 million from July 20, 2021 to March 22, 2022 with an annual interest at 5.3%. On July 8, 2022, YS Group entered into another credit facility of RMB15 million with Shanghai Pudong Development Bank Co., Ltd. for two years to finance its working capital requirements. YS Group repaid approximately RMB39.0 million from July 19, 2022 to September 26, 2022 and drew down approximately RMB 55.9 million from May 12, 2022 to September 23, 2022 with an annual interest at 5.3%.

On September 13, 2021, YS Group entered into a credit facility of RMB 100 million with China Guangfa Bank Co., Ltd. Shenyang Branch for three years to finance its working capital requirements. YS Group drew down approximately RMB46.5 million in total from September 22, 2021 to March 10, 2022 with an annual interest at 5.655%, which is due from September 16, 2022 to December 16, 2022.

On March 16, 2022, YS Group entered into a facility agreement (“Facility Agreement”) with R-Bridge Healthcare Fund, LP, as agent (the “Agent”), to finance RMB253,928,000 (\$40,000,000) for 54 months with an annual interest at 4%. YS Group shall repay the loan in instalments on each repayment date which refers to the fifth business day after each financial quarter date an amount equal to the relevant percentage of the aggregate outstanding principal amount of the loan as at the end of the availability period as set out in the following table:

Repayment Date	Repayment Instalment
April 7, 2025	\$ 6,400,000
July 7, 2025	6,400,000
October 7, 2025	6,400,000
January 7, 2026	6,400,000
April 7, 2026	6,400,000
July 7, 2026	8,000,000
<b>Total</b>	<b>\$40,000,000</b>

YS Group shall pay accrued interest on the Loan on each repayment date. As of March 31, 2022, YS Group accrued approximately RMB395,000 (\$62,222) of interest. For the six months ended September 30, 2022, YS Group accrued approximately RMB11.4 million (\$1.7 million) of interest expenses and royalty fee.

If YS Group fails to pay any amount payable by it under the Facility Agreement on its due date, interest shall accrue on the unpaid sum from the due date to the date of actual payment at annual interest of 3% higher than the rate which would have applied if the unpaid sum had not become due.

Under the terms of the Facility Agreement, YS Group and Agent also entered into a Deed, pursuant to which YS Group will pay to Agent, the Royalties on the Products of YSJA rabies vaccine (royalty products) as contingent interest in addition to the payments made to Agent under the Facility Agreement, on the terms and subject to the conditions of the Deed. YS Group is obliged to pay royalties to such agent as contingent interest for the facility based upon YS Group’s annual net sales of rabies vaccines by multiplying the royalty rate below by the corresponding amount incremental net sales for that financial year.

During the royalty term until (but excluding) the date YS Group repays all outstanding amounts under the Facility Agreement (the “Royalty Reduction Date”), the royalty rates for each financial year shall be as follows (with a cap of RMB60,000,000 per financial year):

Net Sales Tiers	Royalty Rate
For that portion of annual aggregate net sales of Royalty Products in a financial year that are less than or equal to RMB500 million	1.5%
For that portion of annual aggregate net sales of Royalty Products in a financial year that are greater than RMB500 million but less than or equal to RMB1 billion	3.0%
For that portion of annual aggregate net sales of Royalty Products in a financial year that are greater than RMB1 billion	3.5%

If the Royalty Reduction Date occurs after March 18, 2024 and any royalties payable have been duly paid, YS Group shall:

- (a) pay the reduced royalty rates for the remainder of the royalty term as follows (with a cap of RMB24 million per financial year), or

Net Sales Tiers	Royalty Rate
For that portion of annual aggregate net sales of Royalty Products in a financial year that are less than or equal to RMB500 million	0.6%
For that portion of annual aggregate net sales of Royalty Products in a financial year that are greater than RMB500 million but less than or equal to RMB1 billion	1.2%

Net Sales Tiers	Royalty Rate
For that portion of annual aggregate net sales of Royalty Products in a financial year that are greater than RMB1 billion	1.4%

(b) at its option, pay an amount equal to 4% of the principal amount (the “Royalty Repurchase Amount”) prepaid on the Royalty Reduction Date pursuant to the Facility Agreement in addition to the payment of the applicable prepayment fee as defined in the Facility Agreement), then, no royalties shall be due and owing to Agent.

The term of royalty will be commencing on April 1, 2022 until the last day of the relevant financial quarter within which the earliest of the following occurs:

- (a) the date of the payment of the Royalty Repurchase Amount;
- (b) the Royalty Reduction Date, if the Royalty Reduction Date occurs on or prior to March 18, 2024;
- (c) September 30, 2026; and
- (d) the expiration of the term of Facility Agreement.

On May 25, 2022, YS Group entered into a credit facility of RMB30 million with China CITIC Bank and Industrial Bank for one years to finance its working capital requirements. YS Group drew down approximately RMB 29.3 million from May 12, 2022 to July 22, 2022 with an annual interest at 5.2%. YS Group also entered into a letter of credit facility with China CITIC Bank of approximately RMB5 million with an interest of 3.25% per annum.

On September 6, 2022, YS Group entered into a credit facility of RMB50 million with China Construction Bank for one year to finance its working capital requirements. YS Group drew down approximately RMB 12.4 million from September 9, 2022 to September 28, 2022 with an annual interest at 4 %.

YS Group recorded RMB15.2 million (\$2.1 million), RMB2.8 million (\$0.4 million) and RMB5.8 million of interest expense for the six months ended September 30, 2022, and the fiscal years ended March 31, 2022 and 2021, respectively.

#### Lease liabilities

A summary of YS Group’s operating leases as of March 31, 2022 and September 30, 2022 is as follows:

Fiscal Year Ending March 31,	As of March 31, 2022		As of September 30, 2022	
	(RMB)	(\$)	(RMB)	(\$)
2023	4,947,481	\$ 779,352	5,748,070	\$ 809,610
2024	4,837,260	761,989	5,029,426	708,390
2025	4,922,251	775,377	3,921,138	552,289
2026	1,479,661	233,084	158,029	22,257
2027 and thereafter	—	—	—	—
<b>Total lease payments</b>	<b>16,186,653</b>	<b>2,549,802</b>	<b>14,856,663</b>	<b>2,092,546</b>
Less: Interest	(1,259,141)	(198,346)	(928,262)	(130,744)
<b>Present value of operating lease liabilities</b>	<b>14,927,512</b>	<b>\$2,351,456</b>	<b>13,928,401</b>	<b>\$1,961,802</b>

As of September 30, 2022, the outstanding, discounted amount of lease liabilities was RMB13.9 million (\$2.0 million) which was related to the lease agreements for two premises in China, one premises in Singapore and one premises in United States.

#### Contingencies

In 2018, Liaoning Yisheng filed a sales contract dispute with Hebei Defense Biological Products Supply Center. The Supreme People’s Court of Liaoning supported the Liaoning Yisheng’s claim that the defendant Hebei

Weifang should pay RMB2,465,807 for Liaoning Yisheng vaccine within 20 days after the judgment came into effect. As of the date of this report, YS Group received RMB1,636,755 compensation from Hebei Defense Biological Products Supply Center and the balance of RMB829,052 compensation may be received in fiscal year 2024.

In 2019, Liaoning Yisheng filed a sales contract dispute with Chaoyang Center for Disease Control and Prevention. The Supreme People's Court of Liaoning supported the Liaoning Yisheng's claim that the defendant Chaoyang Center for Disease Control and Prevention should pay RMB416,900 for Liaoning Yisheng vaccine. To the date, YS Group received RMB300,000 from Chaoyang Center for Disease Control and Prevention, and the balance of RMB116,900 may be received in fiscal year 2023.

YS Group was also involved in certain other labor disputes as of September 30, 2022. As the proceedings are in the early stages, there is considerable uncertainty regarding the timing or ultimate resolution of such matters, and therefore, an estimate for the reasonably possible loss or a range of reasonably possible losses cannot be made.

### **Holding Company Structure**

YS Biopharma is a holding company with no business operations of its own. YS Biopharma conducts a substantial portion of its business and operations through its PRC subsidiaries, in particular, Liaoning Yisheng and Beijing Yisheng, and a substantial portion of its assets are located in China. As a result, its ability to pay dividends and to service any debt it may incur overseas largely depends upon dividends paid by its subsidiaries. If its subsidiaries incur debt on their own behalf in the future, the instruments governing their debt may restrict their ability to pay dividends to YS Biopharma.

In addition, YS Biopharma's subsidiaries in China are permitted to pay dividends to their shareholder only out of their after-tax profits, if any, as determined in accordance with the Accounting Standards for Business Enterprise as promulgated by the Ministry of Finance of the PRC (the "PRC GAAP"). The aggregate Accumulated Deficit for its PRC subsidiaries as determined under the Accounting Standards for Business Enterprise were RMB553.0 million, RMB582.0 million (\$91.7 million) and RMB509.2 million (\$71.7 million) as of March 31, 2021 and 2022 and September 30, 2022, respectively. In addition, pursuant to the relevant PRC laws, enterprises in the PRC have to make appropriation from their after-tax profit, as determined under PRC GAAP, to statutory common reserve funds. The appropriation to the statutory common reserve fund must be at least 10% of the after-tax profits calculated in accordance with PRC GAAP. Appropriation is not required if the reserve fund has reached 50% of the registered capital of such PRC enterprise. See the section entitled "YS Biopharma's Business — Regulation" for a detailed discussion of the PRC legal restrictions on dividends and its ability to transfer cash within its group. In addition, holders of YS Biopharma's securities may potentially be subject to PRC taxes on dividends paid by it in the event YS Biopharma is deemed as a PRC resident enterprise for PRC tax purposes. See the section entitled "Material Taxation Consideration — Material PRC Tax Considerations" for more details.

None of YS Biopharma's PRC subsidiaries have issued any dividends or distributions to respective holding companies, including YS Biopharma, or any investors as of the date of this prospectus. YS Biopharma's subsidiaries in the PRC generate and retain cash generated from operating activities and re-invest it in its business. Historically, Liaoning Yisheng has also received equity financing from its shareholders to fund business operations of YS Biopharma's PRC subsidiaries. In the fiscal years ended March 31, 2021 and 2022, YS Biopharma transfer cash proceeds to Liaoning Yisheng were RMB428.5 million and RMB291.1 million (\$45.1 million). In the six months ended September 30 of 2021 and 2022, YS Biopharma transfer cash proceeds to Liaoning Yisheng were RMB291.1 million and nil, respectively. In the future, cash proceeds raised from overseas financing activities may be transferred by YS Biopharma through its subsidiaries outside China to its PRC subsidiaries via capital contribution and shareholder loans, as the case may be. Its PRC subsidiaries will pay dividends to their offshore shareholder to meet the capital needs of YS Biopharma's business operations out of the PRC. For details about the applicable PRC regulations and rules relating to such cash transfers through YS Group and the associated risks, see the section entitled "Risk Factors — Risks Related to Doing Business in China."

Cash is transferred among YS Biopharma, its offshore subsidiaries and its PRC subsidiaries, in the following manner: (i) funds are transferred to its PRC subsidiaries from YS Biopharma as needed through YS

Biopharma’s subsidiaries outside China in the form of capital contributions or shareholder loans, as the case may be; and (ii) dividends or other distributions may be paid by its PRC subsidiaries to the Company through its subsidiaries outside China. Its subsidiaries in the PRC generate and retain cash generated from operating activities and re-invest it in its business. None of its subsidiaries outside China has made distribution to certain shareholders. In the future, YS Biopharma’s ability to pay dividends, if any, to its shareholders and warrant holders and to service any debt it may incur will depend upon dividends paid by its subsidiaries. In the two fiscal years ended March 31, 2022 and six months ended September 30, 2022, YS Group did not transfer any cash proceeds to any of YS Group’s PRC subsidiaries except for the cash transfers within YS Group in connection with the paid-in capital in YS Group’s PRC subsidiaries. \$59,900,000 of the registered capital was paid up by HK Yisheng to Liaoning Yisheng during the fiscal year ended March 31, 2021. \$45,099,071.49 of the registered capital was paid up by HK Yisheng to Liaoning Yisheng during the fiscal year ended March 31, 2022. No registered capital was paid up by HK Yisheng to Liaoning Yisheng during the six months ended September 30, 2022.

#### **Off-Balance Sheet Arrangements**

YS Group has no off-balance sheet arrangements. YS Group has not entered into any financial guarantees or other commitments to guarantee the payment obligations of any third parties. YS Group has not entered into any derivative contracts that are indexed to its shares and classified as shareholders’ equity or that are not reflected in its consolidated financial statements. Furthermore, YS Group does not have any retained or contingent interest in assets transferred to an unconsolidated entity that serves as credit, liquidity, or market risk support to such entity. YS Group does not have any variable interest in any unconsolidated entity that provides financing, liquidity, market risk or credit support to us or that engages in leasing, hedging or research and development services with it.

#### **Internal Control over Financial Reporting**

YS Biopharma is a private company with limited accounting personnel and other resources to address its internal control over financial reporting. YS Group’s management has not completed an assessment of the effectiveness of its internal control and procedures over financial reporting and its independent registered public accounting firm has not conducted an audit of its internal control over financial reporting. In connection with the audit of its consolidated financial statements as of and for the years ended March 31, 2022 and 2021, YS Group and its independent registered public accounting firm identified a material weakness in its internal control over financial reporting as of March 31, 2022. As defined in the standards established by the PCAOB, a “material weakness” is a deficiency, or combination of deficiencies, in internal control over financial reporting, such that there is a reasonable possibility that a material misstatement of its annual or interim consolidated financial statements will not be prevented or detected on a timely basis.

The material weakness identified relates to lack of sufficient competent financial reporting and accounting personnel with appropriate understanding of U.S. GAAP to design and implement formal period-end financial reporting policies and procedures to address complex U.S. GAAP technical accounting issue; and to prepare and review the Group’s consolidated financial statements and related disclosures in accordance with U.S. GAAP and financial reporting requirements set forth by the SEC. To remediate its identified material weakness, YS Group has adopted measures to improve its internal control over financial reporting, including, among others: (i) hiring additional qualified accounting and financial personnel with appropriate knowledge and experience in U.S. GAAP accounting and SEC reporting, and (ii) organizing regular training for its accounting staffs, especially training related to U.S. GAAP and SEC reporting requirements. YS Group also plans to adopt additional measures to improve its internal control over financial reporting, including, among others, creating U.S. GAAP accounting policies and procedures manual, which will be maintained, reviewed and updated, on a regular basis, to the latest U.S. GAAP accounting standards, and further hiring executive accounting personnel with strong knowledge and experience in U.S. GAAP accounting and SEC reporting.

However, YS Group cannot assure you that all these measures will be sufficient to remediate its material weakness in time, or at all. See the section entitled “Risk Factors — Risks Related to Ownership of the YS Biopharma Ordinary Shares — If YS Group fails to remediate its material weakness and implement and maintain an effective system of internal controls over financial reporting, YS Group may be unable to accurately report its results of operations, meet its reporting obligations or prevent fraud.”



As a company with less than \$1.235 billion in revenue for its last fiscal year, YS Biopharma qualifies as an “emerging growth company” pursuant to the JOBS Act. An emerging growth company may take advantage of specified reduced reporting and other requirements that are otherwise applicable generally to public companies. These provisions include exemption from the auditor attestation requirement under Section 404 of the Sarbanes-Oxley Act of 2002 in the assessment of the emerging growth company’s internal control over financial reporting.

### **Critical Accounting Policies and Estimates**

YS Group’s consolidated financial statements have been prepared in accordance with generally accepted accounting principles in the United States. The preparation of these consolidated financial statements requires us to make judgments and estimates that affect the reported amounts of assets, liabilities, revenues and expenses, and the disclosure of contingent assets and liabilities in YS Group’s financial statements. YS Group bases its estimates on historical experience, known trends and events and various other factors that YS Group believes are reasonable under the circumstances, the results of which form the basis for making judgments about the carrying values of assets and liabilities that are not readily apparent from other sources. YS Group evaluates its estimates and assumptions on an ongoing basis. YS Group’s actual results may differ from these estimates under different assumptions or conditions. On an ongoing basis, YS Group evaluates its judgments and estimates in light of changes in circumstances, facts, and experience. The effects of material revisions in estimates, if any, will be reflected in the consolidated financial statements prospectively from the date of change in estimates.

While YS Group’s significant accounting policies are described in more detail in Note 3 to its audited annual consolidated financial statements appearing elsewhere in this proxy statement/prospectus, YS Group believes that the following accounting policies are those most critical to the judgments and estimates used in the preparation of its financial statements.

### ***Revenue from Contracts with Customers***

YS Group follows ASC 606 — “Revenue from Contracts with Customers” for all periods presented. ASC 606 established principles for reporting information about the nature, amount, timing, and uncertainty of revenue and cash flows arising from YS Group’s contracts to provide services to customers. Based on the following five steps analysis, revenues from contracts with customers are recognized when control of the promised goods or services is transferred to the customers, in an amount that reflects the consideration YS Group expects to be entitled in exchange for those goods or services.

Step 1: Identify the contract with the customer;

Step 2: Identify the performance obligations in the contract;

Step 3: Determine the transaction price;

Step 4: Allocate the transaction price to the performance obligations in the contract; and

Step 5: Recognize revenue when YS Group satisfies a performance obligation.

YS Group is principally engaged in the research, development, manufacturing and sale of vaccines and therapeutic biologics. YS Group’s revenues primarily streams from the sales of vaccines.

The core principle underlying the revenue recognition ASC 606 is that YS Group recognizes revenue to represent the transfer of vaccines to customers in an amount that reflects the consideration to which YS Group expects to be entitled in such exchange. This requires YS Group to identify contractual performance obligations and determine whether revenue should be recognized at a point in time or over time. YS Group’s sales contracts of vaccines have one single performance obligation that is to sell vaccines to the customers. The sales contracts with customers do not involve variable considerations, such as discounts and rebates. And according to the historical operation, circumstance of discounts and rebates have never occurred. The customer pays after acceptance of the vaccines. According to ASC 606, the relevant revenue recognition is based on a point in time of customer acceptance confirmation.

And in accordance with ASC606-10-55-36 through 55-40, YS Group evaluates whether it is appropriate to record the gross amount of vaccines and related costs or the net amount earned as commissions. When the entity is a principal, that the entity obtains control of the specified goods or services before they are transferred to the customers, the revenues should be recognized in the gross amount of consideration to which it expects to be entitled in exchange for the specified goods or services transferred. When the entity is an agent and its obligation is to facilitate third parties in fulfilling their performance obligation for specified goods or services, the revenues should be recognized in the net amount for the amount of commission which the entity earns in exchange for arranging for the specified goods or services to be provided by other parties. Revenues are recorded net of value-added taxes. YS Group sells vaccines to the customers, and it obtains control of the vaccines before customer acceptance confirmation. Therefore, YS Group is a principal, and the revenues should be recognized according to the gross method.

### ***Leases***

Under ASC Topic 842, Leases (“ASC 842”), YS Group determines if an arrangement is or contains a lease at inception. For leases with a term of 12 months or less, YS Group does not recognize a right-of-use asset or lease liability. YS Group’s operating leases are recognized on its consolidated balance sheets as noncurrent assets, current liabilities and noncurrent liabilities. YS Group does not have any finance leases.

Right-of-use assets represent YS Group’s right to use an underlying asset for the lease term and lease liabilities represent YS Group’s obligation to make lease payments arising from the lease. Operating lease right-of-use assets and liabilities are recognized at the lease commencement date based on the present value of lease payments over the lease term. As YS Group’s leases typically do not provide an implicit rate, YS Group uses an estimate of its incremental borrowing rate based on the information available at the lease commencement date in determining the present value of lease payments. The lease terms may include options to extend or terminate the lease when it is reasonably certain that YS Group will exercise that option. Lease expense is recognized on a straight-line basis over the lease term.

### ***Government grants***

Government grants represent primarily subsidies received from PRC governments for operating a business in their jurisdictions and in compliance with specific policies promoted by the government authorities. YS Group’s PRC-based subsidiaries received specific subsidies and other subsidies from certain local governments. Specific subsidies are subsidies the local government has set certain conditions for the subsidies. Other subsidies are subsidies the local government has not set any conditions and are not tied to future trends or performance of YS Group, receipt of such subsidy is not contingent upon any further actions or performance of YS Group and the amounts do not have to be refunded under any circumstances. Specific subsidies are recorded as deferred government grants upon receipt and are recognized as government grants recognized in income when the conditions are met. Other subsidies are recognized as other income upon receipt as further performance by YS Group is not required.

Government grants for research and development (“R&D”) are recognized as a reduction to R&D expenses when the conditions attached to the grants are met or recognized as government grants recognized in income in the period when the conditions are met after the expenses are incurred. Government grants for property, plant and equipment are deferred and recognized as a reduction to the related depreciation and amortization expenses in the same manner as the property, plant and equipment are depreciated.

### ***Fair value measurements***

ASC 825-10 requires certain disclosures regarding the fair value of financial instruments. Fair value is defined as the price that would be received to sell an asset or paid to transfer a liability in an orderly transaction between market participants at the measurement date. A three-level fair value hierarchy prioritizes the inputs used to measure fair value. The hierarchy requires entities to maximize the use of observable inputs and minimize the use of unobservable inputs. The three levels of inputs used to measure fair value are as follows:

- Level 1—inputs to the valuation methodology are quoted prices (unadjusted) for identical assets or liabilities in active markets.

- Level 2 — inputs to the valuation methodology include quoted prices for similar assets and liabilities in active markets, quoted market prices for identical or similar assets in markets that are not active, inputs other than quoted prices that are observable and inputs derived from or corroborated by observable market data.
- Level 3 — inputs to the valuation methodology are unobservable.

Unless otherwise disclosed, the fair value of YS Group's financial instruments including cash, accounts receivable, advances to suppliers, amounts due from related parties, prepaid expenses and other current assets, short-term bank loans and other loans, accounts payable, and accrued expenses and other current liabilities approximate their recorded values due to their short-term maturities. The fair value of longer-term leases approximates their recorded values as their stated interest rates approximate the rates currently available.

YS Group's non-financial assets, such as property and equipment would be measured at fair value only if they were determined to be impaired.

#### ***Impairment of Long-lived Assets***

YS Group reviews long-lived assets, including definitive-lived intangible assets and property and equipment, for impairment whenever events or changes in circumstances indicate that the carrying amount of an asset may not be recoverable. When such events occur, YS Group assesses the recoverability of the asset group based on the undiscounted future cash flows the asset group is expected to generate and recognizes an impairment loss when estimated undiscounted future cash flows expected to result from the use of the asset group plus net proceeds expected from disposition of the asset group, if any, is less than the carrying value of the asset group. If YS Group identifies an impairment, YS Group reduces the carrying amount of the asset group to its estimated fair value based on a discounted cash flow approach or, when available and appropriate, to comparable market values and the impairment loss, if any, is recognized in general and administrative expenses in the consolidated statements of operations. YS Group uses estimates and judgments in its impairment tests and if different estimates or judgments had been utilized, the timing or the amount of any impairment charges could be different. Asset groups to be disposed of would be reported at the lower of the carrying amount or fair value less costs to sell, and no longer depreciated. YS Group did not record any impairment charges during the six months ended September 30, 2022 and 2021, and during the fiscal year ended March 31, 2022 and 2021.

#### ***Share-based payments***

YS Group operates a share option scheme for the purpose of providing incentives and rewards to eligible participants who contribute to the success of YS Group's operations. Employees (including directors) of YS Group receive remuneration in the form of share-based payments, whereby employees render services as consideration for equity instruments ("equity-settled transactions").

The cost of equity-settled transactions with employees for grants is measured by reference to the fair value of the equity instruments at the date at which they are granted. The fair value is determined by an external valuer using a binomial model. The cost of equity-settled transactions is recognized in employee benefit expense, together with a corresponding increase in equity, over the period in which the performance and/or service conditions are fulfilled.

The cumulative expense recognized for equity-settled transactions at the end of each of the Relevant Periods until the vesting date reflects the extent to which the vesting period has expired and YS Group's best estimate of the number of equity instruments that will ultimately vest. The charge or credit to the statement of profit or loss for a period represents the movement in the cumulative expense recognized as at the beginning and end of that period. Service and non-market performance conditions are not taken into account when determining the grant date fair value of awards, but the likelihood of the conditions being met is assessed as part of the Group's best estimate of the number of equity instruments that will ultimately vest. Market performance conditions are reflected within the grant date fair value. Any other conditions attached to an award, but without an associated service requirement, are considered to be non-vesting conditions. Non-vesting conditions are reflected in the fair value of an award and lead to an immediate expensing of an award unless there are also service and/or performance conditions

For awards that do not ultimately vest because non-market performance and/or service conditions have not been met, no expense is recognized. Where awards include a market or non-vesting condition, the transactions are treated as vesting irrespective of whether the market or non-vesting condition is satisfied, provided that all other performance and/or service conditions are satisfied.

Where the terms of an equity-settled award are modified, as a minimum an expense is recognized as if the terms had not been modified, if the original terms of the award are met. In addition, an expense is recognized for any modification that increases the total fair value of the share-based payments or is otherwise beneficial to the employee as measured at the date of modification.

Where an equity-settled award is cancelled, it is treated as if it had vested on the date of cancellation, and any expense not yet recognized for the award is recognized immediately. This includes any award where non-vesting conditions within the control of either the Group or the employee are not met. However, if a new award is substituted for the cancelled award, and is designated as a replacement award on the date that it is granted, the cancelled and new awards are treated as if they were a modification of the original award, as described in the previous paragraph.

### ***Recently Issued Accounting Pronouncements***

In June 2016, the FASB issued Accounting Standards Update (“ASU”) 2016-13, Financial Instruments — Credit Losses (Topic 326). The amendments in this Update require a financial asset (or a group of financial assets) measured at amortized cost basis to be presented at the net amount expected to be collected. The amendments broaden the information that an entity must consider in developing its expected credit loss estimate for assets measured either collectively or individually. The use of forecasted information incorporates more timely information in the estimate of expected credit loss, which will be more decision useful to users of the financial statements. This ASU is effective for annual and interim periods beginning after December 15, 2019 for issuers and December 15, 2020 for non-issuers. Early adoption is permitted for all entities for annual periods beginning after December 15, 2018, and interim periods therein. In May 2019, the FASB issued ASU 2019-05, Financial Instruments — Credit Losses (Topic 326): Targeted Transition Relief. This ASU adds optional transition relief for entities to elect the fair value option for certain financial assets previously measured at amortized cost basis to increase comparability of similar financial assets. The ASUs should be applied through a cumulative-effect adjustment to retained earnings as of the beginning of the first reporting period in which the guidance is effective (that is, a modified retrospective approach). On November 19, 2019, the FASB issued ASU 2019-10 to amend the effective date for ASU 2016-13 to be fiscal years beginning after December 15, 2022 and interim periods therein. YS Group is still evaluating the impact of accounting standard of credit losses on YS Group’s CFS.

In December 2019, the FASB issued ASU 2019-12, Income Taxes (Topic 740): Simplifying the Accounting for Income Taxes, which removes certain exceptions to the general principles in Topic 740, and improves consistent application of and simplify U.S. GAAP for other areas of Topic 740 by clarifying and amending existing guidance. For public business entities, the amendments in this update are effective for fiscal years, and interim periods within those fiscal years, beginning after December 15, 2020. For all other entities, the amendments in this update are effective for fiscal years beginning after December 15, 2021, and interim periods within fiscal years beginning after December 15, 2022. Early adoption of the amendments is permitted. YS Group will adopt this ASU within annual reporting period of March 31, 2023 and expects that the adoption of this ASU will not have a material impact on YS Group’s CFS

YS Group does not believe other recently issued but not yet effective accounting standards, if currently adopted, would have a material effect on YS Group’s consolidated financial position, statements of Income and comprehensive income and cash flows.

### **JOBS Act**

On April 5, 2012, the JOBS Act was signed into law. The JOBS Act contains provisions that, among other things, relax certain reporting requirements for qualifying public companies. YS Group will qualify as an “emerging growth company” and under the JOBS Act and will be allowed to comply with new or revised accounting pronouncements based on the effective date for private (not publicly traded) companies. YS Group is electing to delay the adoption of new or revised accounting standards, and as a result, YS Group may not

comply with new or revised accounting standards on the relevant dates on which adoption of such standards is required for non-emerging growth companies. As a result, YS Group's financial statements may not be comparable to companies that comply with new or revised accounting pronouncements as of public company effective dates.

### **Quantitative and Qualitative Disclosures about Market Risk and Credit Risk**

#### ***Credit Risk***

Credit risk is controlled by the application of credit approvals, limits and monitoring procedures. YS Group manages credit risk through in-house research and analysis of the Chinese economy and the underlying obligors and transaction structures. YS Group identifies credit risk collectively based on industry, geography and customer type. In measuring the credit risk of YS Group's sales to its customers, YS Group mainly reflects the "probability of default" by the customer on its contractual obligations and consider the current financial position of the customer and the current and likely future exposures to the customer.

#### ***Inflation risk***

Inflationary factors, such as increases in the cost of raw materials, personnel and overhead costs, could impair YS Group's operating results. To date, the inflation in China has not materially affected its results of operations. According to the National Bureau of Statistics of China, the year-over-year percent changes in the consumer price index for December 2020 and 2021 were increases of 0.2% and 1.5%, respectively. Although YS Group does not believe that inflation has had a material impact on its financial position or results of operations to date, a high rate of inflation in the future may have an adverse effect on YS Group's ability to maintain current levels of gross margin and operating expenses as a percentage of sales revenue if the revenues from YS Group's products do not increase with such increased costs.

#### ***Interest rate risk***

YS Group's exposure to interest rate risk primarily relates to the interest rate that its deposited cash can earn, on the other hand, interest-earning instruments carry a degree of interest rate risk. YS Group has not been exposed to material risks due to changes in interest rates. An increase, however, may raise the cost of any debt YS Group incurs in the future.

#### ***Foreign Exchange Risk***

While YS Group's reporting currency is Renminbi, almost all of its financing fund are denominated in U.S. dollar. As a result, YS Group is exposed to foreign exchange risk as its financing fund may be affected by fluctuations in the exchange rate between the U.S. dollar and Renminbi. YS Group has not entered into any hedging transactions in an effort to reduce its exposure to foreign exchange risk.

#### ***Research and Development, Patents and Licenses***

For information about YS Group's proprietary intellectual properties and its research and development policies, see the section entitled "YS Biopharma's Business."

#### ***Trend Information***

Other than as disclosed elsewhere in this proxy statement/prospectus, YS Biopharma is not aware of any trends, uncertainties, demands, commitments or events since September 30, 2022 that are reasonably likely to have a material adverse effect on revenues, income, profitability, liquidity or capital resources of YS Group, or that would cause the disclosed financial information to be not necessarily indicative of future results of operations or financial condition.

## UNAUDITED PRO FORMA CONDENSED COMBINED FINANCIAL INFORMATION

The following unaudited pro forma condensed combined balance sheet as of September 30, 2022 and the unaudited pro forma condensed combined statements of operations for the six months ended September 30, 2022 and unaudited pro forma condensed combined statements of operations for the fiscal year ended March 31, 2022 present the combination of the financial information of Summit and YS Biopharma after giving effect to the Business Combination and related adjustments described in the accompanying notes. Summit and YS Biopharma are referred to herein, subsequent to the Business Combination, as the post-combination company.

The unaudited pro forma condensed combined balance sheet combines the unaudited condensed balance sheet of YS Biopharma as of September 30, 2022, with the unaudited condensed consolidated balance sheet of Summit as of September 30, 2022, giving effect to the Business Combination as if it had been consummated on September 30, 2022.

The unaudited pro forma condensed combined statements of operations for the fiscal year ended March 31, 2022 combines the audited condensed statement of operations of YS Biopharma for the fiscal year ended March 31, 2022 with the unaudited condensed statement of operations of for the twelve months ended March 31, 2022 of Summit, giving effect to the Business Combination as if it had occurred on April 1, 2021, the beginning of the earliest period presented.

The unaudited pro forma condensed combined statements of operations for the six months ended September 30, 2022 combines the unaudited condensed statement of operations of YS Biopharma for the six months ended September 30, 2022 with the unaudited condensed statement of operations for the six months ended September 30, 2022 of Summit, giving effect to the Business Combination as if it had occurred on April 1, 2022, the beginning of the earliest period presented.

The unaudited pro forma condensed combined financial information is based on and should be read in conjunction with the consolidated financial statements of Summit and YS Biopharma and the notes thereto, as well as the disclosures contained in the section entitled “Management’s Discussion and Analysis of Financial Condition and Results of Operations” .

The unaudited pro forma condensed combined financial information has been presented for illustrative purposes only and does not necessarily reflect what the post-combination company’s financial condition or results of operations would have been had the Business Combination occurred on the dates indicated. Further, the unaudited pro forma condensed combined financial information also may not be useful in predicting the future financial condition and results of operations of the post-combination company. The actual financial position and results of operations may differ significantly from the pro forma amounts reflected herein due to a variety of factors. The unaudited pro forma adjustments represent management’s estimates based on information available as of the date of these unaudited pro forma condensed combined financial statements and are subject to change as additional information becomes available and analyses are performed.

### **Description of the Business Combination**

The board of directors of Summit has unanimously approved the Business Combination Agreement, by and among Summit, YS Biopharma, Merger Sub I and Merger Sub II. The Business Combination Agreement provides for (i) the merger of Merger Sub I with and into Summit, with Summit surviving the First Merger as the Surviving Entity and becoming a wholly-owned subsidiary of YS Biopharma, and (ii) the merger of the Surviving Entity with and into Merger Sub II, with Merger Sub II surviving the Second Merger as the surviving company and remaining as the wholly-owned subsidiary of YS Biopharma. As a result of and upon consummation of the Business Combination, the shareholders of Summit will become shareholders of YS Biopharma. The respective time at which the First Merger and the Second Merger become effective is sometimes as the “First Merger Effective Time” and “Second Merger Effective Time,” respectively. The consummation of the Mergers is herein referred to as the “Closing,” and the day on which the Closing occurs is herein referred to as the “Closing Date.”

Subject to, and in accordance with the terms and subject to the conditions set forth in the Business Combination Agreement, immediately prior to the First Merger Effective Time, (i) each YS Biopharma Preferred Share will be converted into one Pre Consolidation YS Biopharma Ordinary Share; (ii) every four

of the Pre Consolidation YS Biopharma Ordinary Shares and every four options of YS Biopharma will be consolidated into one YS Biopharma Ordinary Share and one option of YS Biopharma, respectively, subject to rounding up to the nearest whole number of YS Biopharma Ordinary Share; and (iii) the amended and restated memorandum and articles of association of YS Biopharma shall be adopted and become effective. Items (i) through (iii) are herein collectively referred to as the “YS Biopharma Capital Restructuring.”

Subject to, and in accordance with the terms and subject to the conditions set forth in the Business Combination Agreement, following completion of the YS Biopharma Capital Restructuring and immediately prior to the First Merger Effective Time, (i) each of the Units (each consisting of one Summit Class A Ordinary Share and one-half of one Summit Warrant included as part of a Unit) issued and outstanding immediately prior to the First Merger Effective Time shall be automatically detached and the holder thereof shall be deemed to hold one Summit Class A Ordinary Share and one-half of one Summit Warrant (the Unit Separation); (ii) each Summit Class A Ordinary Share (including Summit Class A Ordinary Shares held by Summit’s public shareholders as a result of the Unit Separation and Summit Class A Ordinary Shares to be issued pursuant to the Forward Purchase Subscriptions) issued and outstanding immediately prior to the First Merger Effective Time (other than any treasury Summit Shares, redeeming Summit Shares and dissenting Summit Shares) shall automatically be cancelled and cease to exist in exchange for the right to receive such fraction of newly issued YS Biopharma Ordinary Shares after the YS Biopharma Capital Restructuring that is equal to the Summit Class A Exchange Ratio, without interest; (iii) an aggregate of 1,446,525 Summit Class B Ordinary Shares held by Sponsor will be surrendered for nil consideration, and after such surrender, each of the remaining Summit Class B Ordinary Shares held by Sponsor and the independent directors of Summit issued and outstanding immediately prior to the First Merger Effective Time shall automatically be cancelled and cease to exist in exchange for the right to receive one newly issued YS Biopharma Ordinary Share; (iv) each Summit Class B Ordinary Share held by a Forward Purchase Investor and its permitted transferees issued and outstanding immediately prior to the First Merger Effective Time shall automatically be cancelled and cease to exist in exchange for the right to receive (a) such fraction of newly issued YS Biopharma Ordinary Shares that is equal to the Summit Class A Exchange Ratio, without interest, if and only if such Forward Purchase Investor has fully delivered its portion of the Forward Purchase Investment Amount as required under the applicable Forward Purchase Agreement and, failing that, (b) one newly issued YS Biopharma Ordinary Share; and (v) each whole Summit Warrant outstanding immediately prior to the First Merger Effective Time shall cease to be a warrant with respect to Summit Shares and be assumed by YS Biopharma and converted into a warrant to purchase one YS Biopharma Ordinary Share, subject to substantially the same terms and conditions prior to the First Merger Effective Time. No fractional shares or warrants will be issued in the foregoing process, and all such shares or warrants would be rounded down to the nearest whole number of shares or warrants.

Pursuant to the Business Combination Agreement, (i) each ordinary share, par value \$0.0001 per share, of Merger Sub I that is issued and outstanding immediately prior to the First Merger Effective Time shall automatically convert into one ordinary share, par value \$0.0001 per share, of the Surviving Entity, (ii) each ordinary share of the Surviving Company that is issued and outstanding immediately prior to the Second Merger Effective Time will be automatically cancelled and extinguished without any conversion thereof or payment therefor and (iii) each ordinary share of Merger Sub II issued and outstanding immediately prior to the Second Merger Effective Time shall remain outstanding and shall not be affected by the Second Merger.

#### **Anticipated Accounting Treatment**

Notwithstanding the legal form of the Business Combination pursuant to the Business Combination Agreement, the Business Combination will be accounted as recapitalization. Under this method of accounting, Summit will be treated as the “acquired” company and Yishengbio will be treated as the acquirer for financial statement reporting purposes. YS Biopharma has been determined to be the accounting acquirer based on evaluation of the following facts and circumstances:

- YS Biopharma’s shareholders will have the largest voting interest in the post-combination company under both the no redemption and 100% redemption scenarios;
- YS Biopharma’s shareholders will have the ability to nominate at least a majority of the members of the board of directors of the combined entity;
- YS Biopharma’s senior management is the senior management of the post-combination company;

- YS Biopharma is the larger entity, in terms of substantive operations and employee base.

### **Basis of Pro Forma Presentation**

As noted above, the unaudited pro forma condensed combined financial information contained herein assumes that Summit's shareholders approve the proposed Business Combination. Summit cannot predict how many of the Summit Public Shareholders will exercise their right to have their Summit Public Shares redeemed for cash. As a result, YS Biopharma has elected to provide the unaudited pro forma condensed combined financial information under two different redemption scenarios, which produce different allocations of total YS Biopharma equity between holders of YS Biopharma Ordinary Shares. As described in greater detail below, the first scenario, or "no redemption scenario," assumes that none of the Summit Public Shareholders will exercise their right to have their Summit Public Shares redeemed for cash, and the second scenario, or "100% redemption scenario," assumes that 20,000,000 Summit Public Shares are redeemed for aggregate redemption payments of \$201,200,243, assuming a \$10.06 per share Redemption Price and based on funds in the Trust Account and working capital available to Summit outside of the Trust Account as of September 30, 2022. The actual results will likely be within the parameters described by the two scenarios, however, there can be no assurance regarding which scenario will be closest to the actual results. Under both scenarios, YS Biopharma is considered to be the accounting acquirer.

The following table sets forth summary historical comparative share information for Summit and YS Biopharma and unaudited pro forma condensed combined per share information of the combined company after giving effect to the Business Combination, assuming two redemption scenarios as follows:

- **Assuming No Redemptions:** This presentation assumes that no Summit Public Shareholders elect to have their Summit Public Shares redeemed for cash in connection with the Business Combination as permitted by the Summit Articles and there are no Dissenting Summit Shares.
- **Assuming 100% Redemptions:** This presentation assumes that 20,000,000 Summit Public Shares are redeemed for aggregate redemption payments of \$201,200,243, assuming a \$10.06 per share Redemption Price and based on funds in the trust account as of September 30, 2022. The Business Combination Agreement includes a closing condition, which requires that the Available Closing Cash Amount shall be no less than \$30,000,000. The Available Closing Cash Amount is calculated as the sum of: (i) the amount of cash proceeds from the Trust Account, plus (ii) the aggregate amount of cash that has been funded to, or that will be funded immediately prior to or concurrently with the Closing to Summit pursuant to the Forward Purchase Agreements, plus (iii) any amount raised pursuant to permitted equity financings prior to the Closing (excluding any proceeds that will be invested by existing shareholders or creditors of YS Biopharma immediately prior to the First Merger Effective Time), minus (iv) the aggregate amount payable to Summit Public Shareholders exercising their redemption rights. Accordingly, if no more than 85% of the total Summit Public Shares are redeemed, the Available Closing Cash Amount will be no less than \$30,000,000, even if Summit and YS Biopharma do not receive any proceeds pursuant to the Forward Purchase Agreements or raise any other permitted equity financings prior to the Closing. However, even if the actual redemption percentage is higher than 85%, the Business Combination may still be consummated if (i) YS Biopharma waives the Available Closing Cash Amount as a closing condition, or (ii) the post-redemption cash proceeds in the Trust Account, when combined with proceeds received under the Forward Purchase Agreements and/or other permitted equity financings prior to the Closing, is no less than \$30,000,000.



**UNAUDITED PRO FORMA CONDENSED COMBINED BALANCE SHEET**  
**AS of September 30, 2022**

	SUMMIT HEALTHCARE ACQUISITION CORP. (Historical)	YS Biopharma (Historical)	Pro Forma Adjustments (No Redemption Scenario)	Pro Forma Combined (No Redemption Scenario)	Pro Forma Combined (No Redemption Scenario)	Pro Forma Adjustments (100% Redemption Scenario)	Pro Forma Combined (100% Redemption Scenario)	Pro Forma Combined (100% Redemption Scenario)
	(RMB)	(RMB)	(RMB)	(RMB)	(S)		(RMB)	(S)
<b>ASSETS</b>								
Current Assets:								
Cash and cash equivalents	497,675	226,765,500	—	227,263,175	\$ 32,009,800	—	227,263,175	\$ 32,009,800
	—	—	1,420,595,390	(A)	1,420,595,390	200,089,494	(1,428,481,485)	(7,886,095)
	—	—	212,994,000	(F)	212,994,000	30,000,000	—	212,994,000
	—	—	(30,174,150)	(G)	(30,174,150)	(4,250,000)	—	(30,174,150)
	—	—	4,969,860	(J)	4,969,860	700,000	—	4,969,860
Restricted cash	—	261,766	—	261,766	36,869	—	261,766	36,869
Accounts receivable, net	—	468,359,388	—	468,359,388	65,967,969	—	468,359,388	65,967,969
Advance to suppliers, net	—	7,556,142	—	7,556,142	1,064,275	—	7,556,142	1,064,275
Inventory	—	161,667,187	—	161,667,187	22,770,668	—	161,667,187	22,770,668
Prepaid expenses and other current assets	1,551,626	6,942,700	—	8,494,326	1,196,418	—	8,494,326	1,196,418
<b>Total current assets</b>	<b>2,049,301</b>	<b>871,552,683</b>	<b>1,608,385,100</b>	<b>2,481,987,084</b>	<b>349,585,493</b>	<b>(1,428,481,485)</b>	<b>1,053,505,599</b>	<b>148,385,250</b>
Investments held in Trust Account	1,428,481,485	—	(1,428,481,485)	(A)	—	—	—	—
Property and equipment, net	—	557,366,853	—	557,366,853	78,504,585	—	557,366,853	78,504,585
Intangible assets, net	—	81,314,933	—	81,314,933	11,453,130	—	81,314,933	11,453,130
Operating lease right-of-use assets, net	—	13,067,129	—	13,067,129	1,840,493	—	13,067,129	1,840,493
Deferred tax assets, net	—	2,473,459	—	2,473,459	348,384	—	2,473,459	348,384
Other assets, non-current	—	22,663,063	—	22,663,063	3,192,071	—	22,663,063	3,192,071
<b>Total assets</b>	<b>1,430,530,786</b>	<b>1,548,438,120</b>	<b>179,903,615</b>	<b>3,158,872,521</b>	<b>\$444,924,156</b>	<b>(1,428,481,485)</b>	<b>1,730,391,036</b>	<b>\$243,723,913</b>
<b>LIABILITIES AND EQUITY(DEFICIT)</b>								
Current liabilities:								
Short-term loans	—	163,641,078	—	163,641,078	\$ 23,048,688	—	163,641,078	\$ 23,048,688
Accounts payable	—	37,394,178	—	37,394,178	5,266,934	—	37,394,178	5,266,934
Accrued expenses and other liabilities	—	367,283,321	—	367,283,321	51,731,502	—	367,283,321	51,731,502
Amounts due to related parties	212,994	—	—	212,994	30,000	—	212,994	30,000
Current portion of operating lease liabilities	—	3,524,558	—	3,524,558	496,431	—	3,524,558	496,431
Deferred government grant-current	—	3,495,701	—	3,495,701	492,366	—	3,495,701	492,366
Accrued offering costs and expenses	4,259,568	—	—	4,259,568	599,956	—	4,259,568	599,956
<b>Total current liabilities</b>	<b>4,472,562</b>	<b>575,338,836</b>	<b>—</b>	<b>579,811,398</b>	<b>81,665,877</b>	<b>—</b>	<b>579,811,398</b>	<b>81,665,877</b>
Non-current liabilities:								
Long-term loans	—	283,992,000	—	283,992,000	40,000,000	—	283,992,000	40,000,000
Non-current portion of operating lease liabilities	—	10,403,843	—	10,403,843	1,465,371	—	10,403,843	1,465,371
Deferred government grant-non-current	—	20,826,966	—	20,826,966	2,933,458	—	20,826,966	2,933,458
FPA liability	22,789,847	—	—	22,789,847	3,209,928	—	22,789,847	3,209,928
Warrant liability	17,145,179	—	(10,649,700)	(I)	6,495,479	—	6,495,479	914,882
<b>Total liabilities</b>	<b>44,407,588</b>	<b>890,561,645</b>	<b>(10,649,700)</b>	<b>924,319,533</b>	<b>130,189,516</b>	<b>—</b>	<b>924,319,533</b>	<b>130,189,516</b>

	SUMMIT HEALTHCARE ACQUISITION CORP. (Historical)	YS Biopharma (Historical)	Pro Forma Adjustments (No Redemption Scenario)		Pro Forma Combined (No Redemption Scenario)	Pro Forma Combined (No Redemption Scenario)	Pro Forma Adjustments (100% Redemption Scenario)	Pro Forma Combined (100% Redemption Scenario)	Pro Forma Combined (100% Redemption Scenario)
	(RMB)	(RMB)	(RMB)		(RMB)	(S)		(RMB)	(S)
<b>Shareholders' deficit</b>									
Class A common subject to possible redemption	1,428,481,485	—	(1,428,481,485)	(B)	—	—	—	—	—
Series A redeemable convertible preferred stock	—	551,004,725	(551,004,725)	(C)	—	—	—	—	—
Series B redeemable convertible preferred stock	—	1,057,557,002	(1,057,557,002)	(C)	—	—	—	—	—
Stockholders' (deficit) equity:									
Class A common stock	—	—	3,839	(D)	3,839	541	(3,022)	816	115
	—	—	7,978	(E)	7,978	1,124	—	7,978	1,124
	—	—	589	(F)	589	83	149	738	104
	—	—	3,087	(C)	3,087	435	—	3,087	435
	—	—	1	(G)	1	—	—	1	—
	—	—	1,420	(I)	1,420	200	—	1,420	200
	—	—	99	(J)	99	14	—	99	14
Class B common stock	4,082	—	(4,082)	(D)	—	—	—	—	—
Yisheng common stock	—	7,978	(7,978)	(E)	—	—	—	—	—
Additional paid-in capital	—	808,648,509	—		808,648,509	113,897,365	—	808,648,509	113,897,365
	—	—	1,428,481,485	(B)	1,428,481,485	201,200,243	(1,428,481,485)	—	—
	—	—	1,608,558,640	(C)	1,608,558,640	226,563,937	—	1,608,558,640	226,563,937
	—	—	212,993,411	(F)	212,993,411	29,999,917	(149)	212,993,262	29,999,896
	—	—	(42,362,369)	(H)	(42,362,369)	(5,966,699)	—	(42,362,369)	(5,966,699)
	—	—	(30,174,151)	(G)	(30,174,151)	(4,250,000)	—	(30,174,151)	(4,250,000)
	—	—	60,427,882	(I)	60,427,882	8,511,209	—	60,427,882	8,511,209
	—	—	4,969,761	(J)	4,969,761	699,986	—	4,969,761	699,986
Accumulated deficit	(42,362,369)	(1,673,775,766)	(7,885,852)	(D) (AA)	(1,724,023,987)	(242,827,120)	3,022	(E) (1,724,090,964)	(242,826,694)
	—	—	42,362,369	(H)	42,362,369	5,966,699	—	42,362,369	5,966,699
	—	—	(49,779,602)	(I)	(49,779,602)	(7,011,409)	—	(49,779,602)	(7,011,409)
Accumulated other comprehensive loss	—	(85,565,973)	—		(85,565,973)	(12,051,885)	—	(85,565,973)	(12,051,885)
Total stockholders' (deficit) equity	(42,358,287)	(950,685,252)	3,227,596,527		2,234,552,988	314,734,640	(1,428,481,485)	806,071,503	113,534,397
<b>Total liabilities, convertible preferred stock and stockholders' (deficit) equity</b>	<b>1,430,530,786</b>	<b>1,548,438,120</b>	<b>179,903,615</b>		<b>3,158,872,521</b>	<b>\$ 444,924,156</b>	<b>(1,428,481,485)</b>	<b>1,730,391,036</b>	<b>243,723,913</b>

**UNAUDITED PRO FORMA CONDENSED COMBINED STATEMENT OF OPERATIONS  
FOR THE SIX MONTHS ENDED SEPTEMBER 30, 2022**

	SUMMIT HEALTHCARE ACQUISITION CORP. (Historical)	YS Biopharma (Historical)	Pro Forma Adjustments (No Redemption Scenario)	Pro Forma Combined (No Redemption Scenario)	Pro Forma Combined (No Redemption Scenario)	Pro Forma Adjustments (100% Redemption Scenario)	Pro Forma Combined (100% Redemption Scenario)	Pro Forma Combined (100% Redemption Scenario)
	(RMB)	(RMB)	(RMB)	(RMB)	(S)		(RMB)	(S)
<b>Revenues</b>	—	399,534,723	—	399,534,723	\$ 56,274,081	—	399,534,723	\$ 56,274,081
Cost of revenues	—	93,700,779	—	93,700,779	13,197,665	—	93,700,779	13,197,665
<b>Gross profit</b>	—	305,833,944	—	305,833,944	43,076,416	—	305,833,944	43,076,416
<b>Operating expenses:</b>								
Selling	—	150,228,079	—	150,228,079	21,159,480	—	150,228,079	21,159,480
General and administrative	6,669,240	49,587,013	—	56,256,253	7,923,639	—	56,256,253	7,923,639
Research and development	—	123,861,107	—	123,861,107	17,445,718	—	123,861,107	17,445,718
<b>Total operating expenses</b>	6,669,240	323,676,199	—	330,345,439	46,528,837	—	330,345,439	46,528,837
<b>Loss from operations</b>	(6,669,240)	(17,842,255)	—	(24,511,495)	(3,452,421)	—	(24,511,495)	(3,452,421)
<b>Other (expense) income:</b>								
Late fees related to social security insurance	—	(299,417)	—	(299,417)	(42,173)	—	(299,417)	(42,173)
Government grants	—	22,456,691	—	22,456,691	3,163,003	—	22,456,691	3,163,003
Interest expenses, net	—	(14,949,434)	—	(14,949,434)	(2,105,613)	—	(14,949,434)	(2,105,613)
Other income (expenses), net	—	74,675	—	74,675	10,518	—	74,675	10,518
Change in fair value of FPA	(3,709,066)	—	—	(3,709,066)	(522,418)	—	(3,709,066)	(522,418)
Change in fair value of warrant liability	5,350,784	—	(3,557,000) (J)	1,793,784	252,653	—	1,793,784	252,653
Interest earned on investments held in Trust Account	7,886,095	—	(7,886,095) (AA)	—	—	—	—	—
Gain recognized on extinguishment of deferred underwriting commissions	47,068,000	—	—	47,068,000	6,629,483	—	47,068,000	6,629,483
<b>Total other (expense) income</b>	56,595,813	7,282,515	(11,443,095)	52,435,233	7,385,453	—	52,435,233	7,385,453
<b>Income/(Loss) before income taxes</b>	49,926,573	(10,559,740)	(11,443,095)	27,923,738	3,933,032	—	27,923,738	3,933,032
<b>Income tax expense</b>	—	(565,625)	—	(565,625)	(79,668)	—	(565,625)	(79,668)
<b>Net income/(loss)</b>	49,926,573	(11,125,365)	(11,443,095)	27,358,113	3,853,364	—	27,358,113	3,853,364
Accretion to redemption value of convertible redeemable preferred shares	—	(72,083,238)	—	(72,083,238)	(10,152,855)	—	(72,083,238)	(10,152,855)
<b>Net loss attributable to YishengBio Co. Ltd</b>	49,926,573	(83,208,603)	(11,443,095)	(44,725,125)	\$ (6,299,491)	—	(44,725,125)	\$ (6,299,491)
<b>Net income/(loss)</b>	49,926,573	(11,125,365)	(11,443,095)	27,358,113	3,853,364	—	27,358,113	3,853,364
Foreign currency translation loss	—	(168,653,952)	—	(168,653,952)	(23,754,747)	—	(168,653,952)	(23,754,747)
<b>Total comprehensive income/(loss)</b>	49,926,573	(179,779,317)	(11,443,095)	(141,295,839)	(19,901,383)	—	(141,295,839)	(19,901,383)
<b>Loss per share*:</b>								
– Basic and Diluted	1.94	(0.03)	—	0.24	\$ 0.03	—	0.30	\$ 0.04
<b>Weighted average number of ordinary shares outstanding*:</b>								
– Basic and Diluted	25,750,000	333,699,980	—	113,460,795	113,460,795	—	92,174,995	92,174,995

**UNAUDITED PRO FORMA CONDENSED COMBINED STATEMENT OF OPERATIONS  
FOR THE FISCAL YEAR ENDED MARCH 31, 2022**

	SUMMIT HEALTHCARE ACQUISITION CORP. (Historical)	Yishengbio (Historical)	Pro Forma Adjustments (No Redemption Scenario)	Pro Forma Combined (No Redemption Scenario)	Pro Forma Combined (No Redemption Scenario)	Pro Forma Adjustments (100% Redemption Scenario)	Pro Forma Combined (100% Redemption Scenario)	Pro Forma Combined (100% Redemption Scenario)
	(RMB)	(RMB)	(RMB)	(RMB)	(\$)		(RMB)	(\$)
<b>Revenues</b>	—	502,949,894	—	502,949,894	\$ 79,227,166	—	502,949,894	\$ 79,227,166
Cost of revenues	—	117,066,090	—	117,066,090	18,440,832	—	117,066,090	18,440,832
<b>Gross profit</b>	—	385,883,804	—	385,883,804	60,786,334	—	385,883,804	60,786,334
<b>Operating expenses:</b>								
Selling	—	185,999,704	—	185,999,704	29,299,597	—	185,999,704	29,299,597
General and administrative	5,057,268	107,620,500	—	112,677,768	17,749,562	—	112,677,768	17,749,562
Research and development	—	211,222,263	—	211,222,263	33,272,780	—	211,222,263	33,272,780
Total operating expenses	5,057,268	504,842,467	—	509,899,735	80,321,939	—	509,899,735	80,321,939
<b>Loss from operations</b>	(5,057,268)	(118,958,663)	—	(124,015,931)	(19,535,605)	—	(124,015,931)	(19,535,605)
<b>Other (expense) income:</b>								
Late fees related to taxes other than income tax	—	(231,231)	—	(231,231)	(36,425)	—	(231,231)	(36,425)
Late fees related to social security insurance	—	(1,852,378)	—	(1,852,378)	(291,796)	—	(1,852,378)	(291,796)
Government grants	—	23,020,413	—	23,020,413	3,626,290	—	23,020,413	3,626,290
Interest expenses	—	(2,717,433)	—	(2,717,433)	(428,064)	—	(2,717,433)	(428,064)
Other expenses, net	—	(327,987)	—	(327,987)	(51,666)	—	(327,987)	(51,666)
Change in fair value of FPA	(17,172,164)	—	—	(17,172,164)	(2,705,045)	—	(17,172,164)	(2,705,045)
Change in fair value of warrant liability	67,842,809	—	(41,329,378)	(J) 26,513,431	4,176,527	—	26,513,431	4,176,527
Transaction costs allocable to warrants	(3,277,812)	—	—	(3,277,812)	(516,337)	—	(3,277,812)	(516,337)
Interest earned on investments held in Trust Account	177,095	—	(177,095)	(AA) —	—	—	—	—
<b>Total other income/(expense)</b>	47,569,928	17,891,384	(41,506,473)	23,954,839	3,773,484	—	23,954,839	3,773,484
<b>Income/(Loss) before income taxes</b>	42,512,660	(101,067,279)	(41,506,473)	(100,061,092)	(15,762,121)	—	(100,061,092)	(15,762,121)
<b>Income tax expense</b>	—	(4,937,122)	—	(4,937,122)	(777,720)	—	(4,937,122)	(777,720)
<b>Net income/(loss)</b>	42,512,660	(106,004,401)	(41,506,473)	(104,998,214)	(16,539,841)	—	(104,998,214)	(16,539,841)
Accretion to redemption value of convertible redeemable preferred shares	—	(130,662,326)	—	(130,662,326)	(20,582,579)	—	(130,662,326)	(20,582,579)
<b>Net income/(loss) attributable to YishengBio Co. Ltd</b>	42,512,660	(236,666,727)	(41,506,473)	(235,660,540)	\$(37,122,420)	—	(235,660,540)	\$(37,122,420)

	SUMMIT HEALTHCARE ACQUISITION CORP. (Historical)	Yishengbio (Historical)	Pro Forma Adjustments (No Redemption Scenario)	Pro Forma Combined (No Redemption Scenario)	Pro Forma Combined (No Redemption Scenario)	Pro Forma Adjustments (100% Redemption Scenario)	Pro Forma Combined (100% Redemption Scenario)	Pro Forma Combined (100% Redemption Scenario)
	(RMB)	(RMB)	(RMB)	(RMB)	(\$)		(RMB)	(\$)
<b>Net income/(loss)</b>	<b>42,512,660</b>	<b>(106,004,401)</b>	<b>(41,506,473)</b>	<b>(104,998,214)</b>	<b>\$ (16,539,841)</b>	<b>—</b>	<b>(104,998,214)</b>	<b>\$ (16,539,841)</b>
Foreign currency translation gain	—	38,864,606	—	38,864,606	6,122,146	—	38,864,606	6,122,146
<b>Total comprehensive income/(loss)</b>	<b>42,512,660</b>	<b>(67,139,795)</b>	<b>(41,506,473)</b>	<b>(66,133,608)</b>	<b>\$ (10,417,695)</b>	<b>—</b>	<b>(66,133,608)</b>	<b>\$ (10,417,695)</b>
<b>Loss per share*:</b>								
– Basic and Diluted	2.51	(0.32)	—	(0.93)	\$ (0.15)	—	(1.14)	(0.18)
<b>Weighted average number of ordinary shares outstanding*:</b>								
– Basic and Diluted	16,928,082	333,699,980	—	113,460,795	113,460,795	—	92,174,995	92,174,995

## NOTES TO UNAUDITED PRO FORMA CONDENSED COMBINED FINANCIAL INFORMATION

### Note 1 — Basis of Presentation

The historical information of SUMMIT and YS Biopharma has been adjusted in the unaudited pro forma condensed combined financial information to reflect pro forma adjustments related to the Business Combination in accordance with U.S. GAAP.

The Business Combination will be accounted for as a recapitalization. YS Biopharma has been determined to be the accounting acquirer under Financial Accounting Standards Board's Accounting Standards Codification Topic 805, Business Combinations. The determination is primarily based on the evaluation of the following facts and circumstances:

- YS Biopharma's shareholders will have the largest voting interest in YS Biopharma under both the no redemption and 100% redemption scenarios;
- YS Biopharma's shareholders will have the ability to nominate at least a majority of the members of the Board of Directors of the combined entity;
- YS Biopharma's senior management is the senior management of the post-combination company;
- YS Biopharma is the larger entity, in terms of substantive operations and employee base.

Under the recapitalization model, the Business Combination will be reflected as the equivalent of YS Biopharma issuing stock for the net assets of Summit, accompanied by a recapitalization whereby no goodwill or other intangible assets are recorded.

The unaudited pro forma condensed combined financial information has been prepared in accordance with Article 11 of Regulation S-X as amended by the final rule, Release No. 33 — 10786 "Amendments to Financial Disclosures about Acquired and Disposed Businesses." The unaudited pro forma condensed combined balance sheet as of September 30, 2022 combines the unaudited condensed balance sheet of Summit as of September 30, 2022 with the unaudited condensed consolidated balance sheet of YS Biopharma as of September 30, 2022, giving effect to the Business Combination as if it had been consummated on September 30, 2022. The unaudited pro forma condensed combined statement of operations for the fiscal year ended March 31, 2022 combines the unaudited condensed statement of operations of Summit for the twelve months ended March 31, 2022 with the audited condensed consolidated statement of operations of YS Biopharma for the fiscal year ended March 31, 2022, giving effect to the Business Combination as if it had occurred on April 1, 2021, the beginning of the earliest period presented. The unaudited pro forma condensed combined statement of operations for the six months ended September 30, 2022 combines the unaudited condensed statement of operations of Summit for the six months ended September 30, 2022 with the unaudited condensed consolidated statement of operations of YS Biopharma for the six months ended September 30, 2022, giving effect to the Business Combination as if it had occurred on April 1, 2022, the beginning of the earliest period presented.

As noted above, the unaudited pro forma condensed combined financial information contained herein assumes that Summit's shareholders approve the proposed Business Combination. Summit cannot predict how many of the Summit Public Shareholders will exercise their right to have their Summit Public Shares redeemed for cash. As a result, YS Biopharma has elected to provide the unaudited pro forma condensed combined financial information under two different redemption scenarios, which produce different allocations of total YS Biopharma equity between holders of YS Biopharma Ordinary Shares. As described in greater detail below, the first scenario, or "no redemption scenario," assumes that none of the Summit Public Shareholders will exercise their right to have their Summit Public Shares redeemed for cash, and the second scenario, or "100% redemption scenario," assumes that 20,000,000 Summit Public Shares are redeemed for aggregate redemption payments of \$201,200,243, assuming a \$10.06 per share Redemption Price and based on funds in the Trust Account and working capital available to Summit outside of the Trust Account as of September 30, 2022. The actual results will likely be within the parameters described by the two scenarios, however, there can be no assurance regarding which scenario will be closest to the actual results. Under both scenarios, YS Biopharma is considered to be the accounting acquirer.

The following table sets forth summary historical comparative share information for Summit and YS Biopharma and unaudited pro forma condensed combined per share information of the combined company after giving effect to the Business Combination, assuming two redemption scenarios as follows:

- **Assuming No Redemptions:** This presentation assumes that no Summit Public Shareholders elect to have their Summit Public Shares redeemed for cash in connection with the Business Combination as permitted by the Summit Articles and there are no Dissenting Summit Shares.
- **Assuming 100% Redemptions:** This presentation assumes that 20,000,000 Summit Public Shares are redeemed for aggregate redemption payments of \$201,200,243, assuming a \$10.06 per share Redemption Price and based on funds in the trust account as of September 30, 2022. The Business Combination Agreement includes a closing condition, which requires that the Available Closing Cash Amount shall be no less than \$30,000,000. The Available Closing Cash Amount is calculated as the sum of: (i) the amount of cash proceeds from the Trust Account, plus (ii) the aggregate amount of cash that has been funded to, or that will be funded immediately prior to or concurrently with the Closing to Summit pursuant to the Forward Purchase Agreements, plus (iii) any amount raised pursuant to permitted equity financings prior to the Closing (excluding any proceeds that will be invested by existing shareholders or creditors of YS Biopharma immediately prior to the First Merger Effective Time), minus (iv) the aggregate amount payable to Summit Public Shareholders exercising their redemption rights. Accordingly, if no more than 85% of the total Summit Public Shares are redeemed, the Available Closing Cash Amount will be no less than \$30,000,000, even if Summit and YS Biopharma do not receive any proceeds pursuant to the Forward Purchase Agreements or raise any other permitted equity financings prior to the Closing. However, even if the actual redemption percentage is higher than 85%, the Business Combination may still be consummated if (i) YS Biopharma waives the Available Closing Cash Amount as a closing condition, or (ii) the post-redemption cash proceeds in the Trust Account, when combined with proceeds received under the Forward Purchase Agreements and/or other permitted equity financings prior to the Closing, is no less than \$30,000,000.

#### **Note 2—Accounting Policies**

Upon consummation of the Business Combination, management will perform a comprehensive review of the two entities' accounting policies. As a result of the review, management may identify differences between the accounting policies of the two entities which, when conformed, could have a material impact on the financial statements of the post-combination company. Based on its initial analysis, management did not identify any differences that would have a material impact on the unaudited pro forma condensed combined financial information. As a result, the unaudited pro forma condensed combined financial information does not assume any differences in accounting policies.

#### **Note 3—Adjustments to Unaudited Pro Forma Condensed Combined Financial Information**

The pro forma adjustments included in the unaudited pro forma condensed combined balance sheet as of September 30, 2022 and in the unaudited pro forma condensed combined statements of operations for the six months ended September 30, 2022 are based on preliminary estimates. The final amounts recorded may differ from the information presented.

##### ***Adjustments to Unaudited Pro Forma Condensed Combined Balance Sheet***

The pro forma adjustments included in the unaudited pro forma condensed combined balance sheet as of September 30, 2022 are as follows:

- (A) Reflects the liquidation and reclassification of approximately RMB1.4 billion of cash and marketable securities held in the Trust Account to cash and cash equivalents upon consummation of the Business Combination.
- (B) Reflects the reclassification of Summit Class A common stock subject to possible redemption to permanent equity.
- (C) Reflects the conversion of YS Biopharma's outstanding Series A redeemable convertible preferred stock and Series B redeemable convertible preferred stock into post-combination company common stock pursuant to the exchange ratio of one-for-one base.

(D) Reflects the new issued shares to Summit shareholders and conversion of Summit Class B common stock to Summit Class A common on a one-for-one basis. As a result, each issued and outstanding the Summit Class A Share will no longer be outstanding and will automatically be converted into the right of the holder thereof to receive one YS Biopharma Ordinary Share.

(E) Reflects the conversion of YS Biopharma's outstanding common stock into post-combination company common stock on a one-for-one basis effective upon the Closing.

(F) Represents cash proceeds of RMB213.0 million (\$30,000,000) from the private placement of 3,394,507 YS Biopharma Class A ordinary shares under a no redemption scenario and 4,446,525 YS Biopharma Class A ordinary shares under a 100% redemption scenario (after giving effect to the Class A exchange ratio) and 750,000 Warrants (the "Forward Purchase Securities") pursuant to the Forward Purchase Agreements.

(G) Represents estimated transaction costs of RMB30.2 million (\$4,350,000) incurred by Summit and YS Biopharma related to the Business Combination, including an cash payment of \$4.25 million and \$0.1 million worth of stock compensation.

(H) Reflects the elimination of Summit's historical accumulated deficit.

(I) Represents the classification of 10,000,000 Public Warrants issued by Summit between liabilities and equity upon the consummation of the business combination.

(J) Represents \$700,000 under the Convertible Promissory Note to the Sponsor issued by Summit that will be converted into warrants at a conversion price of \$1.00 per warrant, with each warrant entitling the holder to purchase one Class A ordinary share.

#### ***Statements of Operations***

The pro forma adjustments included in the unaudited pro forma condensed combined statements of operations for the six months ended September 30, 2022 and for the fiscal year ended March 31, 2022 is as follows:

(AA) Represents the elimination of interest earned on investments held in Summit's Trust Account.

#### **Note 4 — Net Loss per Share**

Net loss per share was calculated using the historical weighted average shares outstanding, and the issuance of additional shares in connection with the Business Combination, assuming the shares were outstanding since July 1, 2021. As the Business Combination and related transactions are being reflected as if they had occurred at the beginning of the period presented, the calculation of weighted average shares outstanding for basic and diluted net loss per share assumes that the shares issuable in the Business Combination have been outstanding for the entirety of the period presented. If the number of shares of Public Shares described under the "Assuming 100% Redemptions" scenario described above are redeemed, this calculation is retroactively adjusted to eliminate such shares for the entire period.

The unaudited pro forma condensed combined financial information has been prepared to present two alternative scenarios with respect to redemption of ordinary shares by Public Shareholders at the time of the Business Combination for the six months ended September 30, 2022:



	Historical			Pro Forma Combined <sup>(4)</sup>	
	Summit		YS Biopharma	Assuming No Redemption	Assuming 100% Redemption
	Class A Shares	Class B Shares	Ordinary Shares	Ordinary Shares	Ordinary Shares
<b>As of and For the Six Months Ended September 30, 2022</b>					
Net earnings (loss) per share-basic and diluted (in RMB)	1.94	1.94	(0.03)	0.24	0.30
Net earnings (loss) per share-basic and diluted in (\$)	\$ 0.27	\$ 0.27	\$ (0.01)	\$ 0.03	\$ 0.04
<b>As of and For the Fiscal Year Ended March 31, 2022</b>					
Net earnings (loss) per share-basic and diluted (in RMB)	2.51	2.51	(0.32)	(0.93)	(1.14)
Net earnings (loss) per share-basic and diluted in (\$)	\$ 0.40	\$ 0.40	\$ (0.05)	\$ (0.15)	\$ (0.18)
YS Biopharma Shareholders	—	—	—	83,424,995	83,424,995
Summit Public Shareholders <sup>(3)</sup>	—	—	—	22,337,818	—
Sponsor and certain Summit directors <sup>(1)(2)</sup>	—	—	—	3,928,475	3,928,475
Forward Purchase Investors <sup>(1)</sup>	—	—	—	3,769,507	4,821,525
Weighted average shares outstanding – basic and diluted	20,000,000	5,750,000	333,699,980	113,460,795 <sup>(5)</sup>	92,174,995 <sup>(5)</sup>

- (1) The share amounts reflect the transfer of 375,000 Founder Shares of Summit from the Sponsor to the Forward Purchase Investors in connection with the Forward Purchase Agreements. The 375,000 outstanding Summit Class B ordinary shares held by the Forward Purchase Investors are exchanged into Summit Class A ordinary shares on a one-for-one basis. In addition, on April 30, 2021, the Company entered into forward purchase agreements with the Sponsor, Snow Lake Capital (HK) Limited and Valliance Fund, pursuant to which the Forward Purchase Investors agreed to subscribe for an aggregate of 3,000,000 Summit Class A ordinary shares. Assuming the Forward Purchase Investors fully pay their purchase price in accordance with the forward purchase agreements, each Summit Class A ordinary share held by the Forward Purchase Investors is then converted into such number of YS Biopharma Class A ordinary shares equal to the Class A Exchange Ratio of (i) 1.1169 under a No Redemption Scenario or (ii) 1.4286 under a 100% redemption Scenario. The historical book value per share for YS Biopharma is calculated by dividing total shareholders' deficit, by the number of ordinary shares outstanding at the end of the period.
- (2) The share amounts reflect the Sponsor will surrender 1,446,525 Summit Class B Ordinary Shares for nil consideration immediately prior to the First Merger Effective Time and exchange all of the remaining Summit Shares held by it into YS Biopharma Ordinary Shares on a one-for-one basis at the First Merger Effective Time.
- (3) Outstanding Summit Class A ordinary shares held by the Summit Public Shareholders are converted into the number of YS Biopharma Class A ordinary shares equal to the Class A Exchange Ratio of (i) 1.1169 under a No Redemption Scenario or (ii) 1.4286 under a 100% redemption Scenario.
- (4) The public warrants, private placement warrants and shares of YS Biopharma options were excluded from the computation of pro forma net loss per share, basic and diluted, for the fiscal year ended March 31, 2022 and the six months ended September 30, 2022 because their effect would be anti-dilutive. The share amounts do not take into account (i) 10,000,000 shares of public warrants and 6,750,000 shares of private placement warrants that will remain outstanding immediately following the Business Combination and may be exercised thereafter and (ii) 6,656,582 shares of outstanding YS Biopharma options, vested or unvested, that were

assumed by YS Biopharma upon the completion of the Business Combination. If the actual facts are different than the assumptions set forth above, the share amounts and percentage ownership numbers set forth above will be different (iii) 700,000 shares under the Convertible Promissory Note that will remain outstanding immediately following the Business Combination and may be exercised thereafter.

- (5) The share amount includes (i) 83,424,995 shares held by existing YS Biopharma's shareholders and (ii) in the case of no redemption, 30,035,800 shares to be issued to non-redeeming Summit Shareholders and Forward Purchase Investors upon completion of the Business Combination. The share amount does not include 10,000 shares to be issued as part of advisory fees to YS Biopharma's financial advisor.

## MANAGEMENT OF YS BIOPHARMA FOLLOWING THE BUSINESS COMBINATION

### Directors and Executive Officers

The following table sets forth certain information relating to the executive officers and directors of YS Biopharma immediately after the consummation of the Business Combination.

Name	Age	Position/Title
Yi Zhang	66	Director and Chairperson
Dr. Hui Shao	54	Director, President and Chief Executive Officer
Ms. Rui Lin*	51	Director
Mr. Zhi Chen*	40	Director
Mr. Bo Tan**	49	Director Appointee
Dr. Ajit Shetty	76	Independent Director
Dr. Viren Mehta	72	Independent Director
Dr. Stanley Yi Chang	64	Independent Director
Mr. Shaojing Tong**	51	Independent Director Appointee
Dr. Zenaida Reynoso Mojares	64	Chief Medical Officer
Ms. Chunyuan Wu	45	Chief Financial Officer
Dr. Yuan Liu	36	Head of vaccine research
Mr. Gang Li	41	Head of marketing and sales

\* Each of Ms. Rui Lin and Mr. Zhi Chen will resign as a director of YS Biopharma before the First Merger Effective Time and will not serve any position of the YS Biopharma upon and following the consummation of the Business Combination.

\*\* Each of Mr. Bo Tan and Mr. Shaojing Tong has accepted appointments to be YS Biopharma's independent director, effective upon the First Merger Effective Time.

**Mr. Yi Zhang** is the founder of YS Group and has served as the chairman of the board of YS Biopharma since November 16, 2020 and will continue to serve as the Chairman of YS Biopharma upon consummation of the Business Combination. Mr. Zhang has over 30 years of experience in research, development and commercialization of immunological biologics and vaccines. Since the inception of Yisheng Biopharma Co., Ltd. ("Yisheng Biopharma"), the predecessor of YS Biopharma in February 2010, Mr. Zhang has been its director. He was the chief executive officer of Yisheng Biopharma from February 2010 to February 2018. Mr. Zhang has been the chairman of the board of Liaoning Yisheng since April 2005. He was the inventor of the first aluminum-free rabies vaccine and human rabies immunoglobulin in China. He was also the project leader of national 863 scientific project "SARS Immunoglobulin" and several other national key medical innovation projects funded by Chinese government. From June 1986 to May 2002, Mr. Zhang served as a physician and as the division head of Kaifeng Suburb CDC. From August 1981 to May 1986, Mr. Zhang was a physician for epidemic prevention in Zhongmou County CDC.

Mr. Zhang graduated from Kaifeng Health Science School in October 1981 with a major in clinical medicine. Mr. Zhang is also the director in the Henan Red Cross Society.

**Dr. Hui Shao** has served as the executive director and chief executive officer of YS Group since December 31, 2020 and will continue to serve as the Director and Chief Executive Officer of YS Biopharma upon consummation of the Business Combination. Dr. Shao served as the director, president and chief executive officer of Yisheng Biopharma from February 2018 to December 2020, and prior to that, as the chief financial officer and global business head of the same company since October 2010. Dr. Shao served as the senior vice president of finance and then the chief financial officer of Aoxing Pharmaceutical Company, Inc. from January 2007 to October 2010, where he was responsible for preparing financial statements in accordance with U.S. GAAP and SEC rules and regulations. From 2005 to 2007, Dr. Shao was a senior biotechnology analyst at Kamunting Street Capital Management in New York. From 2003 to 2005, Dr. Shao was a healthcare analyst at Mehta Partners in New York. Prior to that, Dr. Shao had spent five years as a principal scientist at Roche Pharmaceuticals, USA.

Dr. Shao received his bachelor's degree in chemistry from University of Science & Technology of China in 1991, his Ph.D. degree in bioorganic chemistry from University of California, San Diego in 1996, and an M.B.A. degree in finance and accounting from Stern School of Business, New York University in 2003. Dr. Shao is a chartered financial analyst and AICPA holder in the State of Washington, the United States.

**Ms. Rui Lin** has served as a non-executive director of YS Biopharma since December 2020. Ms Lin will resign as a director of YS Biopharma before the consummation of the Business Combination and will not serve any position of the Combined Entity upon the consummation of the Business Combination. Ms. Lin has over 20 years of extensive experience in the financial industry. Ms. Lin joined Fidelity Growth (Shanghai) Equity Investment Management Co., Ltd in April 2015 and served as a Senior Partner since January 2021. Prior to that, from July 1994 to July 1997, she served as the senior auditor in Arthur Andersen (Shenzhen). From September 2000 to July 2001, Ms. Lin served as the management consultant in A.T.Kearney (currently known as Kearney). Ms. Lin also served as the Director in Vision Capital China from September 2001 to April 2005 and as the Director in CMT China Value Capital from May 2005 to April 2007. Ms. Lin joined FIL Capital Management (Hong Kong) Limited in June 2007, and served as a Partner from January 2012 to March 2015.

Ms. Lin received her Bachelor's degree in International Finance from Shenzhen University in 1994, and a Master's degree in MBA from the Wharton School of Business, University of Pennsylvania in 2000.

**Mr. Chen Zhi** has served as a non-executive director of YS Biopharma since December 2020. Mr. Chen will resign as a director of YS Biopharma before the consummation of the Business Combination and will not serve any position of the Combined Entity upon the consummation of the Business Combination. Mr. Chen has over 10 years of extensive experience in the financial industry and R&D in biotech company. Mr. Chen has been the Executive Director of Oceanpine Capital since April 2019. Prior to that, from March 2017 to April 2019, he served as the associate in 3E Bioventure Capital. From 2012 to 2017, Mr. Chen served as the project manager in Staidson Pharmaceutical.

Mr. Chen received his Bachelor's degree in Central South University in 2004, and a PhD's degree in Drug Design from the Chinese Academy of Sciences in 2009.

**Mr. Bo Tan**, is the Chief Executive Officer and Co-Chief Investment Officer of Summit and will serve as a Director of YS Biopharma upon consummation of the Business Combination. Mr. Tan has over 20 years of extensive experience in the financial and pharmaceutical industries. He is the founding partner of Hannut Capital since 2021 and was the President and Chief Financial Officer of 3S Bio from December 2016 to December 2019. During his tenure at 3S Bio, Mr. Tan led the privatization of 3SBio and its re-listing in Hong Kong in 2015, as well as the acquisition and integration of Sciprogen, Sirton (Italy), Wanma and CP Guojian. From 2015 to 2019, Mr. Tan was voted the "Best CFO" for consecutive years in the Institutional Investor All-Asia Executive Team poll. Before joining 3S Bio, Mr. Tan served as the executive director and a member of Investment Committee of Bohai Industrial Investment Fund Management Company, a PRC-based private equity firm, and presided over the investment in The Chengdu Commercial Bank, from April 2007 to September 2008. Prior to that, Mr. Tan served as a vice president in the equity research division of Lehman Brothers Asia Limited from March 2006 to March 2007 and as a senior analyst at Macquarie Securities Asia in Hong Kong from October 2004 to February 2006. Mr. Tan is widely acclaimed for his stellar track record of combining business operations and capital market prowess and has long-standing strategic relationships with major MNCs.

Mr. Tan received his Bachelor's degree in Economics from Renmin University of China in July 1994, Master's degree in Economics from the University of Connecticut in December 1996 and a Master of International Management from Thunderbird School of Global Management in August 1998.

**Dr. Ajit Shetty**, has served as the independent non-executive director of YS Group since January 2021 and will continue to serve as independent director of YS Biopharma upon consummation of the Business Combination. Dr. Shetty has served as a director of Actinium Pharmaceuticals, Inc., a company listed on the New York Stock Exchange (ATNM.US), since March 2017. He has also been a director of Agile Therapeutics, Inc., a company listed on the Nasdaq (AGRX.US), since February 2016. He has been an independent director of reMYND NV since August 2012. From February 2004 to February 2012, Dr. Shetty served as the chairman of the board of directors of Janssen Pharmaceutica NV, a pharmaceutical company and subsidiary of Johnson & Johnson, a company listed on the New York Stock Exchange (JNJ.US). From July 2007 to

February 2012, he served as the Global Head of the enterprise supply chain in Johnson & Johnson and was a member of the corporate operating committee.

Dr. Shetty is a member of the Board of Trustees of Carnegie Mellon University. In 2004, Dr. Shetty was elected as Manager of the Year in Flanders, Belgium. In 2007, Dr. Shetty received the title of Baron for his exceptional merits and contribution to the country of Belgium. In 2008, he was conferred an honorary doctorate by Manipal University (India). In 2016, Dr. Shetty was named as Chairperson of the Flemish Institute of Biotechnology (VIB), a Belgium-based life sciences research institute with a focus on translating scientific results into pharmaceutical, agricultural and industrial applications.

Dr. Shetty received a Ph.D. degree in metallurgy and a master's degree in natural sciences from Trinity College, Cambridge University in April 1972 and June 1968, respectively. He also received an M.B.A. degree from Carnegie Mellon University in June 1974.

**Dr. Viren Mehta**, has served as the independent non-executive director of YS Group since January 2021 and will continue to serve as independent director of YS Biopharma upon consummation of the Business Combination. Dr. Mehta has an extensive experience in investment research and strategic advisory services, focusing on the pharmaceutical and biotechnology industry. He is the founder and managing member of Mehta Partners, LLC since February 1997. He has been a director of Onconova Therapeutics Inc., a company listed on Nasdaq (ONTX.US), since February 2004. From April 2013 to December 2017, Dr. Mehta served as the executive chair and co-founder of Gather Health Ltd, one of the early telehealth initiatives based in Hong Kong. Dr. Mehta served as a director of BlinkBio Inc. from September 2010 to December 2020. From November 1999 to June 2010, Dr. Mehta served as a director of OSI Pharmaceuticals Inc., when Astellas of Japan acquired OSI for \$4 billion. Dr. Mehta also actively works with not-for-profit-enterprises around the world focused on education, ecology, and healthcare.

Dr. Mehta received his Ph.D. degree of pharmacy from the University of Southern California in August 1974 and his M.B.A. degree from the University of California, Los Angeles in December 1980.

**Dr. Stanley Yi Chang**, has served as the independent non-executive director of YS Group since January 2021 and will continue to serve as independent director of YS Biopharma upon consummation of the Business Combination. Dr. Chang is currently an independent non-executive director of Nongfu Spring Co., Ltd., a company listed on the main board the Stock Exchange (9633.HK). Dr. Chang is currently a standing council member of China Institute of Internal Audit, and a member of Auditing Expert Panel of Asian Development Bank. He is also the Audit Committee Chair (Board Member) of CoWealth Co. (603122.SH). Dr. Chang has been a professor at Shanghai Advance Institute of Finance of Shanghai Jiaotong University since July 2018. He was a professor at National Taiwan University from August 2016 to June 2018. Prior to that, Dr. Chang had successively served as the chief operating officer of MarcumBP where he also led its China Advisory Services; managing partner of China Advisory Services and global business risk services leader for Grant Thornton; and partner of business risk services and Asia Pacific life sciences leader for Ernst & Young from September 2007 to October 2016.

Dr. Chang received his Ph.D. degree in accounting from Texas Tech University in the United States in August 1987; his master's degree in accounting from University of Missouri-Columbia in the United States in August 1983; and his bachelor's degree in business administration from National Taiwan University in June 1980. Dr. Chang is a Certified Public Accountant of Texas, United States.

**Mr. Shaojing Tong**, will serve as an independent director of YS Biopharma upon consummation of the Business Combination. Mr. Tong, who has nearly 20 years of experience in investment banking focusing on the global healthcare sector, has acquired an in-depth understanding of both the U.S. and Asian healthcare markets. He has served as the chief financial officer of InnoCare Pharma Limited, a company listed on the Stock Exchange (9969.HK) since June 2019. From July 2013 to May 2019, Mr. Tong was employed by UBS AG with his last position as executive director in the investment banking research department. From May 2008 to May 2013, Mr. Tong was employed by Bank of America Merrill Lynch with his last position as director in global research. From June 2001 to April 2008, Mr. Tong served as an equity analyst in global pharmaceutical equity research at Mehta Partners.

Mr. Tong received his bachelor's degree in material science and engineering from the University of Science and Technology of China (Hefei) in July 1993, his master's degree in chemistry from the University of Pittsburgh in August 1996 and an M.B.A. degree in finance from New York University in May 2001.

**Dr. Zenaida Reynoso Mojares**, has served as the chief medical officer of YS Group since January 2022 and will continue to serve as the Chief Medical Officer of YS Biopharma upon consummation of the Business Combination. She is responsible for the strategy, direction and execution of the R&D and global clinical trial programs. Dr. Mojares is responsible for the strategy, direction and execution of the R&D and global clinical development and clinical operations. Dr. Mojares is a highly accomplished medical professional with diverse experience in medical, clinical research, pharmacovigilance and public health in both private and national government sectors. From July 2021 to January 2022 and from August 2020 to June 2021, she served as the Chief Medical Officer and the Head of Clinical Development & Regulatory department respectively at the International Vaccine Institute in Seoul, South Korea. Her responsibilities included execution and delivery of funded clinical trials, supporting the development of new project opportunities, supervising the clinical team and developing clinical strategy. From June 2017 to July 2020, she served as the Regional Medical Director at Takeda Pharmaceuticals International AG, Vaccines Business Unit in Zurich, Switzerland. From March 2016 to June 2017, she served as the Senior Clinical Research & Development Lead at GSK Vaccines in Singapore and eventually relocated to GSK Vaccines Srl, R&D Center in Italy and was responsible for clinical development activities. From March 2015 to February 2016, she served as the chief medical officer, ad interim and lead regional physician in GlaxoSmithKline Pte Limited Singapore. From July 2011 to March 2015, she served several positions including Region International Physician Lead in Novartis Asia Pacific Pharmaceuticals Pte Ltd.

Dr. Mojares received her Bachelor's degree of Science in General from University of Santo Tomas in 1979 and received her Doctor of Medicine degree from Perpetual Help College of Medicine in 1990. She is a Diplomate of the Philippine College of Gerontology & Geriatrics in 2004. She also received a Master of Science degree in Vaccinology and Pharmaceutical Clinical Development from Università degli Studi di Siena and Novartis Vaccines & Diagnostics, Siena Italy, in April 2011 and a Master's degree in Public Health (MPH) from University of the Philippines in 2004.

**Ms. Chunyuan Wu**, has served as the chief financial officer of YS Group since December 31, 2020 and will continue to serve as the Chief Financial Officer of YS Biopharma upon consummation of the Business Combination. She is responsible for the overall finance management, including designing and developing objectives on tax planning, structuring bank loans for its subsidiaries, overseeing daily operation of the financial team, and working with external advisers for business expansion. Ms. Wu served as the chief financial officer of YS Group Biopharma from February 2018 to December 2020, after five years of serving as the financial controller at the same company since February 2013. From September 2010 to December 2012, Ms. Wu was the financial controller of Jilin Milk Ground Group where she oversaw the financial operation of the company, and was responsible for the preparation of the financial statements in accordance with IFRS and PRC GAAP. From October 2005 to August 2010, Ms. Wu served as a senior auditor at Ernst & Young. From January 2005 to September 2005, she served as an auditor of Shine Wing.

Ms. Wu graduated from Business School of Washington State University (Pullman) in May 2001 with double majors in accounting and finance and minor in economics. Ms. Wu has achieved FCCA and CPABC.

**Dr. Yuan Liu**, has served as the head of vaccine research of YS Group since January 2019 and will continue to serve as the head of vaccine research of YS Biopharma upon consummation of the Business Combination. She is responsible for the research and development of vaccine adjuvant, including PIKA hepatitis B vaccine, human PIKA rabies vaccine and new adjuvant based tumor vaccine under development. Dr. Liu also served as the project leader of R&D department of YS Group Xingye from July 2014 to January 2019 and subsequently has served as the vice president of research department of YS Group Xingye since January 2019. Dr. Liu has focused on the research of vaccine adjuvants for over 10 years. In 2016, she won the sponsorship of young backbone individual project by Beijing outstanding talent training fund.

Dr. Liu received her Ph.D. degree in University of Chinese Academy of Sciences in July 2014. She received her bachelor's degree in Sun Yat-sen University in July 2008.

**Mr. Gang Li**, has served as the head of marketing and sales of YS Group since March 2019 and will continue to serve as the head of vaccine research of YS Biopharma upon consummation of the Business Combination. He is responsible for the management of the overall marketing system. Prior to joining YS Group, he had served in GlaxoSmithKline (China) Investment Co., Ltd. since July 2009, responsible for the daily business management of the certain vaccine in North China. From May 2009 to June 2009, he served as a medical

information specialist in Pfizer Investment Co., Ltd. From September 2006 to April 2009, he served as a pharmaceutical representative of GSK. From July 2003 to July 2006, he served in the sales department of Shenwei Pharmaceutical Ltd.

Mr. Li received his bachelor's degree in Hebei Medical University in July 2003. He received an M.B.A. degree in Sorbonne Business School in May 2018.

### **Board of Directors**

The board of directors of YS Biopharma will initially consist of seven directors immediately after the consummation of the Business Combination. Of these initial seven directors, four will be independent. The Amended YS Biopharma Articles provide that the minimum number of directors shall be three (3). A director is not required to hold any shares in YS Biopharma by way of qualification. A director may vote in respect of any contract or proposed contract or arrangement in which such director may be interested provided that (a) the nature of his/her interest is declared at a meeting of the directors, either specifically or by way of a general notice, and subject to the Nasdaq rules and disqualification by the chairperson of the relevant Board meeting, such director's vote may be counted in the quorum at any meeting of directors at which any such contract or proposed contract or arrangement is considered, and (b) if such contract or arrangement is a transaction with a related party, such transaction has been approved by the audit committee. The directors may exercise all the powers of YS Biopharma to raise or borrow money, mortgage or charge its undertaking, property and assets (present and future) and uncalled capital, and issue debentures or other securities whether outright or as security for any obligation of YS Biopharma or of any third party. No YS Biopharma non-employee director has a service contract with YS Biopharma that provides for benefits upon termination of service.

### **Duties of Directors**

Under Cayman Islands law, the board of directors of YS Biopharma has the powers necessary for managing, and for directing and supervising, its business affairs. The functions and powers of the board of directors of YS Biopharma include, among others:

- convening shareholders' annual and extraordinary general meetings and reporting its work to shareholders at such meetings;
- declaring dividends and distributions;
- appointing officers and determining the term of office of the officers;
- exercising the borrowing powers of YS Biopharma and mortgaging the property of YS Biopharma; and
- approving the transfer of shares in YS Biopharma, including the registration of such shares in its share register.

Under Cayman Islands law, directors owe the following fiduciary duties: (i) duty to act in good faith in what the director believes to be in the best interests of the company as a whole; (ii) duty to exercise powers for the purposes for which those powers were conferred and not for a collateral purpose; (iii) directors should not improperly fetter the exercise of future discretion; (iv) duty not to put themselves in a position in which there is a conflict between their duty to the company and their personal interests; and (v) duty to exercise independent judgment. In addition to the above, directors also owe a duty to exercise the skill they actually possess and such care and diligence that a reasonably prudent person would exercise in comparable circumstances.

As set out above, directors have a duty not to put themselves in a position of conflict and this includes a duty not to engage in self-dealing, or to otherwise benefit as a result of their position. However, in some instances what would otherwise be a breach of this duty can be forgiven and/or authorized in advance by the shareholders provided that there is full disclosure by the directors. This can be done by way of permission granted in the memorandum and articles of association or alternatively by shareholder approval at general meetings.

### **Appointment and Removal of Directors**

The Amended YS Biopharma Articles provide that all directors may be appointed by ordinary resolution and removed by ordinary resolution except with regard to the removal of the chairperson of the Board, who may be removed from office by special resolution). In addition, (a) the YS Biopharma Board may appoint any person as a director, to fill a casual vacancy on the YS Biopharma Board or as an addition to the existing Board, and (b) the Sponsor may, at any time, appoint two directors on the YS Biopharma Board by delivering a written notice to YS Biopharma. A director appointed by the Sponsor may be replaced or removed by the Sponsor. Subject to the Shareholders Agreement, a director may be removed from office by the affirmative vote of two-thirds (2/3) of the directors then in office (except with regard to the removal of the chairperson of the Board, who may be removed from office by the affirmative vote of all remaining directors). The Amended YS Biopharma Articles also provide that the directors may, so long as a quorum of directors remains in office, appoint any person to be a director so as to fill a casual vacancy or as an addition to the existing board of director. YS Biopharma's directors do not serve for a fixed term and there is no requirement for them to retire by rotation nor to make themselves eligible for re-election.

The office of a director shall be vacated if (a) such director resigns their office by notice in writing signed by such director and left at the registered office of YS Biopharma; (b) such director becomes bankrupt or makes any arrangement or composition with such director's creditors generally; (c) such director dies or is found to be or becomes of unsound mind; (d) such director ceases to be a director by virtue of, or becomes prohibited from being a director by reason of, an order made under any provisions of any law or enactment; (e) such director is removed from office by notice addressed to such director at their last known address and signed by all of the co-directors (not being less than two in number); or (f) such director is removed from office by ordinary resolution.

### **Terms of Directors and Officers**

A director shall hold office until such time as he or she resigns his office by notice in writing to YS Biopharma, is removed from office by ordinary resolution or is otherwise disqualified from acting as a director or removed in accordance with the Amended YS Biopharma Articles. An appointment of a director may be on terms that the director shall automatically retire from office (unless he has sooner vacated office) at the next or a subsequent annual general meeting or upon any specified event or after any specified period in a written agreement between YS Biopharma and the director, if any; but no such term shall be implied in the absence of express provision.

### **Employment Agreements and Indemnification Agreements**

Each of the executive officers is party to an employment agreement with YS Biopharma. Under these agreements, the employment of each of executive officers is for a specified time period, and may be terminated for cause, at any time, for certain acts of the executive officer, such as continued failure to satisfactorily perform, willful misconduct or gross negligence in the performance of agreed duties, conviction or entry of a guilty or nolo contendere plea of any felony or any misdemeanor involving moral turpitude, or dishonest act that results in material to its detriment or material of the employment agreement. The employment may also be terminated without cause upon 60-to-120 day advance written notice. The executive officer may resign at any time with a 60-to-120 day advance written notice.

The employment agreements with the other executive officers also include confidentiality and non-disclosure restrictions and non-competition and non-solicitation restrictions that apply during employment for certain periods following termination of employment.

YS Biopharma will enter into indemnification agreements with each of its directors and executive officers. Under these agreements, YS Biopharma may agree to indemnify its directors and executive officers against certain liabilities and expenses incurred by such persons in connection with claims made by reason of their being a director or officer of YS Biopharma.

### **Board Committees**

The YS Biopharma Board will establish an audit committee, a compensation committee and a nominating and corporate governance committee upon the Closing. Each committee's members and functions are described below.



It is anticipated that the YS Biopharma Board will determine that each of Stanley Yi Chang, Ajit Shetty and Viren Mehta satisfies the requirements for an “independent director” within the meaning of the NASDAQ listing rules and the criteria for independence set forth in Rule 10A-3 of the Exchange Act.

#### ***Audit Committee***

The audit committee will consist of Stanley Yi Chang, Shaojing Tong and Viren Mehta. Stanley Yi Chang will be the chairperson of the audit committee. Stanley Yi Chang satisfies the criteria of an audit committee financial expert as set forth under the applicable rules of the SEC.

The audit committee will oversee YS Biopharma’s accounting and financial reporting processes. The audit committee will be responsible for, among other things:

- appointing the independent auditors and pre-approving all auditing and non-auditing services permitted to be performed by the independent auditors;
- reviewing with the independent auditors any audit problems or difficulties and management’s response;
- discussing the annual audited financial statements with management and the independent auditors;
- reviewing the adequacy and effectiveness of YS Biopharma’s accounting and internal control policies and procedures and any steps taken to monitor and control major financial risk exposures;
- reviewing and approving all proposed related party transactions;
- meeting separately and periodically with management and the independent auditors;
- monitoring compliance with YS Biopharma’s code of business conduct and ethics, including reviewing the adequacy and effectiveness of YS Biopharma’s procedures to ensure proper compliance.

#### ***Compensation Committee***

The compensation committee will consist of Viren Mehta, Ajit Shetty, Stanley Yi Chang and Shaojing Tong. Viren Mehta will be the chairperson of the compensation committee.

The compensation committee will be responsible for, among other things:

- reviewing and approving, or recommending to the board for its approval, the compensation for YS Biopharma’s chief executive officer and other executive officers;
- reviewing and recommending to the board for determination with respect to the compensation of YS Biopharma’s non-employee directors;
- reviewing periodically and approving any incentive compensation or equity plans, programs or similar arrangements; and
- the selection of compensation consultant, legal counsel or other adviser only after taking into consideration all factors relevant to that person’s independence from management.

#### ***Nominating and Corporate Governance Committee***

The nominating and corporate governance committee will consist of Ajit Shetty, Viren Mehta, Stanley Yi Chang and Yi Zhang. Ajit Shetty will be the chairperson of the nominating and corporate governance committee.

The nominating and corporate governance committee will be responsible for, among other things:

- selecting and recommending to the YS Biopharma Board nominees for election by the shareholders or appointment by the YS Biopharma Board;
- reviewing annually with the YS Biopharma Board the current composition of the YS Biopharma Board with regard to characteristics such as independence, knowledge, skills, experience and diversity;
- making recommendations on the frequency and structure of YS Biopharma Board meetings and monitoring the functioning of the committees of the YS Biopharma Board; and

- advising the YS Biopharma Board periodically with regard to significant developments in the law and practice of corporate governance as well as YS Biopharma's compliance with applicable laws and regulations, and making recommendations to the YS Biopharma Board on all matters of corporate governance and on any remedial action to be taken.

#### **Code of Business Conduct and Ethics**

YS Biopharma has adopted a Code of Business Conduct and Ethics applicable to its directors, officers and employees. YS Biopharma seeks to conduct business ethically, honestly, and in compliance with applicable laws and regulations. YS Biopharma's Code of Business Conduct and Ethics sets out the principles designed to guide YS Biopharma's business practices- compliance, integrity, respect and dedication. The code applies to all directors, officers, employees and extended workforce, including the Chairperson and Chief Executive Officer and Chief Financial Officer. Relevant sections of the code also apply to members of the YS Biopharma Board. YS Group expects its suppliers, contractors, consultants, and other business partners to follow the principles set forth in its code when providing goods and services to YS Biopharma or acting on YS Biopharma's behalf.

#### **Compensation of Directors and Executive Officers**

In the fiscal year ended March 31, 2022, YS Group paid an aggregate of RMB5.6 million and RMB0.4 million in cash compensation and benefits in kind to YS Biopharma's directors and executive officers as a group, respectively, and YS Group did not pay any cash compensation to its non-executive directors except for independent directors. Each of YS Biopharma's directors and officers is entitled to reimbursement for all necessary and reasonable expenses properly incurred in the course of employment or service. YS Biopharma has not set aside or accrued any amount to provide pension, retirement or other similar benefits to its executive officers and directors, except that YS Biopharma's subsidiaries in the PRC are required by law to make contributions equal to certain percentages of each employee's salary for his or her pension insurance, medical insurance, unemployment insurance and other statutory benefits and a housing provident fund. YS Biopharma's board of directors may determine compensation to be paid to the directors and the executive officers following the consummation of the Business Combination. The compensation committee will assist the directors in reviewing and approving the compensation structure for the directors and the executive officers.

For information regarding share awards granted to YS Biopharma's directors and executive officers, see the section entitled "— Share Incentive Plans."

#### **Share Incentive Plan**

On December 31, 2020, YS Group's board of directors adopted the 2020 Share Incentive Plan of YS Group (the "YS Biopharma 2020 Plan") for the purpose of granting share-based compensation awards to employees, directors and consultants to incentivize their performance and align their interests with YS Group. Pursuant to such plan, YS Biopharma is entitled to grant awards to directors, employees and consultants of YS Group with rights to subscribe for up to 35,000,000 underlying ordinary shares of YS Biopharma (prior to the YS Biopharma Share Consolidation).

In connection with the Business Combination, YS Biopharma has approved and adopted the amended and restated YS Biopharma 2020 Share Incentive Plan (the "YS Biopharma 2022 Plan"), effective as of the First Merger Effective Time, to resume all the terms and conditions of the YS Biopharma 2020 Plan to continue to incentivize directors, employees and consultants of YS Biopharma and its subsidiaries for future development of its business and R&D activities, as well as to reflect the YS Biopharma Capital Restructuring in connection with the Business Combination, including, among others, the consolidation of each four options of YS Biopharma granted immediately prior to the First Merger Effective Time into one option under the YS Biopharma 2022 Plan and adjustment of related exercise price for such share consolidation purpose.

The following summarizes the material terms of the YS Biopharma 2022 Plan:

*Shares Subject to the Plan.* Initially, the maximum number of YS Biopharma Ordinary Shares that may be issued under the YS Biopharma 2022 Plan will be 6,656,582 YS Biopharma Ordinary Shares. If an award

terminates, expires, or lapses for any reason without having been exercised or settled in full, the number of shares subject to the award shall again be available for the grant of an award pursuant to the YS Biopharma 2022 Plan.

*Types of awards.* The plan administrator shall determine the type or types of award(s) to be made to each selected eligible person. The types of awards that may be granted under the YS Biopharma 2022 Plan include share options, share appreciation rights, restricted share units and other awards approved by the plan administrator.

*Plan Administration.* The YS Biopharma 2022 Plan shall be subject to the administration of the YS Biopharma Board or one or more committees or person as authorized and appointed by the YS Biopharma Board. Pursuant to the YS Biopharma 2022 Plan, the committee shall be comprised solely of one or more directors or such number of directors as may be required under applicable laws as the plan administrator. The plan administrator shall have the right to (i) determine eligibility and the particular eligible persons who will receive an award under the YS Biopharma 2022 Plan; (ii) grant awards, determine the price and the number of securities and other terms (e.g., any performance criteria upon which the exercise of an option or the settlement of an award is conditioned) of awards granted thereto; (iii) approve the forms of award agreements; (iv) construe and interpret the terms of the YS Biopharma 2022 Plan and any agreements in relation to the YS Biopharma 2022 Plan; (v) prescribe, amend and rescind rules and regulations relating to the Plan; (vi) modify or amend each award; and (vi) make such other decisions or take any other action as it shall deem appropriate in the administration of the YS Biopharma 2022 Plan.

*Award Agreement.* Each award shall be evidenced by a written award agreement in the form approved by the plan administrator and executed on behalf of YS Biopharma or as required by the plan administrator. The award agreement shall set forth the material terms and conditions of the award as established by the plan administrator consistent with the express limitations of the YS Biopharma 2022 Plan.

*Eligibility.* Persons eligible to participate in the YS Biopharma 2022 Plan will be those officers, employees and directors of any member of the proposed listing group, individual consultant or adviser as selected from time to time by the administrator of this plan. However, persons eligible to participate in the performance-based awards will be those officers and employees of any member of the proposed listing group.

*Effect of termination of services.* Unless YS Biopharma's Board otherwise expressly provides, (1) to the extent an outstanding option granted under such plan has not become vested and exercisable on the date the participant's employment by or service to the proposed listing group terminates, the option to the extent unvested and unexercisable shall terminate, and (2) any shares subject to a restricted share award that remain subject to restrictions at the time the participant's employment by or service to the proposed listing group terminates shall not vest and YS Biopharma shall have the right to reacquire any such unvested shares subject to such award in such manner and on such terms as the administrator provides, which terms shall include return or repayment of the lower of the fair market value or the original purchase price of the restricted shares, without interest, to the participant to the extent not prohibited by law.

*Performance Criteria.* YS Biopharma 2022 Plan allows the administrator to establish the performance criteria when granting stock options on the basis of any one of, or combination of, earnings per share, cash flow, total shareholder return, gross revenue, revenue growth, operating income (before or after taxes), net earnings, return on equity, return on assets, return on investment, cost containment or reduction. The applicable performance measurement period may not be less than three months nor more than 10 years.

*Vesting Schedule.* In general, the plan administrator determines the vesting schedule, which is specified in the relevant award agreement.

*Exercise of options.* The plan administrator determines the exercise price for each award, which is stated in the award agreement. The vested portion of option will expire if not exercised prior to the time as the plan administrator determines at the time of its grant. However, the maximum exercisable term is 10 years.

*Transfer restrictions.* Unless otherwise determined by the plan administrator and so provided in the applicable award agreement, all awards are non-transferable and shall not be subject in any manner to sale, transfer, anticipation, alienation, assignment, pledge, encumbrance or charge. All awards shall be exercised only by the grantee and amounts payable or shares issuable pursuant to any award shall be delivered only to (or for the account of) the grantee.

*Dissolution, Liquidation or Change in Control.* Upon a dissolution, liquidation of YS Biopharma or other events that YS Biopharma do not survive (or does not survive as a public company in respect of its ordinary shares), then each then outstanding option and share appreciation right shall become fully vested, all outstanding restricted shares shall fully vest free of restrictions, and all other outstanding awards granted under the YS Biopharma 2022 Plan shall become payable to the holders of such awards; provided that such acceleration provision shall not apply, unless otherwise expressly provided by the administrator, with respect to any award to the extent that the administrator has made a provision for the substitution, assumption, exchange or other continuation or settlement of the award, or the award would otherwise continue in accordance with its terms, in the circumstances. In the event of a change in control event, the administrator may, in its discretion, provide that any outstanding options or share appreciation rights shall become fully vested, that any restricted shares shall fully vest free of restrictions, and that any other outstanding awards granted under the YS Biopharma 2022 Plan shall be payable to the holders of such awards. The administrator may take such action with respect to all outstanding awards or only with respect to certain specific awards identified by the administrator.

*Payment.* The consideration to be paid for the shares to be issued under the YS Biopharma 2022 Plan, including the method of payment, shall be determined by the plan administrator subject to the provisions in the YS Biopharma 2022 Plan and applicable law. The tax withholding to be paid for the shares shall be determined according to the provisions in the plan and applicable law.

*Duration.* Subject to the termination provisions under the YS Biopharma 2022 Plan, the YS Biopharma 2022 Plan shall be valid and effective for a period of 10 years commencing on the effective date after which period no further awards will be granted, but previously granted awards (and the authority of the plan administrator with respect thereto, including the authority to amend such awards) shall remain outstanding in accordance with their applicable terms and conditions and the terms and conditions of the YS Biopharma 2022 Plan.

*Termination and amendment.* Unless terminated earlier, the YS Biopharma 2022 Plan has a term of 10 years, effective from the date of approval by the shareholders. The board of directors of YS Biopharma has the authority to amend or terminate the plan. To the extent required by applicable law or any applicable listing agency or required under the Internal Revenue Code of 1986 or deemed necessary or advisable by the board of directors, the amendment this plan shall be subject to the shareholders' approval. However, no such action may adversely affect in any material way any awards previously granted without the prior written consent of the recipient.

As of the date of this proxy statement/prospectus, assuming the consummation of the YS Biopharma Share Consolidation, under the YS Biopharma 2020 Plan, an aggregate of 6,656,582 ordinary shares of YS Biopharma are reserved but not issued, all of which will be assumed by the YS Biopharma 2022 Plan upon the First Merger Effective Time, subject to certain adjustment.

The following table sets forth, assuming the consummation of the YS Biopharma Share Consolidation, the number of options granted and outstanding under the YS Biopharma 2020 Plan as of the date of this proxy statement/prospectus, which will be assumed by the YS Biopharma 2022 Plan:

Name of Grantee	YS Biopharma Ordinary Shares Underlying Options Awarded	Exercise Price Per YS Biopharma Ordinary Share (\$)	Grant Date	Expiration Date
Mr. Yi Zhang	1,037,549	2.1956 – 8.276	December 31, 2020	December 30, 2030
Dr. Yuan Liu	23,811	4.0724 – 8.276	December 31, 2020	December 30, 2030
Mr. Gang Li	10,965	4.0724 – 8.276	December 31, 2020	December 30, 2030
Other over 450 employees	2,399,221	4.0724 – 8.276	December 31, 2020	December 30, 2030

\* Less than 1% of the total YS Biopharma shares outstanding immediately upon the consummation of the Business Combination.

## MATERIAL TAX CONSIDERATIONS

### U.S. Federal Income Tax Considerations to U.S. Holders

#### *General*

The following is a general discussion of certain material U.S. federal income tax consequences to U.S. Holders (as defined below) (i) of the Business Combination (excluding any redeemed shares), (ii) of the exercise of redemption rights with respect to Summit Public Shares, and (iii) of the subsequent ownership and disposition of YS Biopharma Ordinary Shares and YS Biopharma Warrants (collectively, the “YS Biopharma Securities”) received in the Business Combination.

No ruling has been requested or will be obtained from the IRS regarding the U.S. federal income tax consequences of the Business Combination; thus, there can be no assurance that the IRS will not challenge the U.S. federal income tax treatment described below or that, if challenged, such treatment will be sustained by a court.

This summary is limited to U.S. federal income tax considerations relevant to U.S. Holders that hold Summit Securities and, after the completion of the Business Combination, YS Biopharma Securities, as “capital assets” within the meaning of Section 1221 of the Code (generally, property held for investment). This discussion does not address all aspects of U.S. federal income taxation that may be important to U.S. Holders in light of their individual circumstances, including U.S. Holders subject to special treatment under U.S. tax laws, such as, for example:

- Sponsor or any member, founder, officer, or director thereof;
- banks, financial institutions, or financial services entities;
- broker-dealers or traders in securities or currencies;
- persons that are subject to the mark-to-market accounting rules;
- tax-exempt entities (including private foundations);
- S-corporations, partnerships, and other pass-through entities or arrangements (and investors therein);
- governments or agencies or instrumentalities thereof;
- insurance companies;
- pension or retirement plans;
- cooperatives;
- regulated investment companies;
- real estate investment trusts;
- U.S. expatriates or former citizens or long-term residents of the United States;
- persons that actually or constructively own five percent or more of the shares of Summit or, following the Business Combination, YS Biopharma by vote or value;
- persons that acquired Summit Securities pursuant to an exercise of employee share options, in connection with employee share incentive plans, or otherwise as compensation;
- persons that hold Summit Securities, or will own YS Biopharma Securities, in connection with a trade or business, permanent establishment, or fixed place of business outside the United States;
- persons that hold Summit Securities, or will own YS Biopharma Securities, as part of a straddle, constructive sale, hedging, conversion, or other integrated or similar transaction; or
- persons whose functional currency is not the U.S. dollar.

As used in this proxy statement/prospectus, the term “U.S. Holder” means a beneficial owner of Summit Securities or YS Biopharma Securities, as the case may be, that is for U.S. federal income tax purposes:

- an individual who is a citizen or resident of the United States;
- a corporation (or other entity treated as a corporation for U.S. federal income tax purposes) that is created or organized in or under the laws of the United States, any state thereof, or the District of Columbia;
- an estate the income of which is subject to U.S. federal income taxation regardless of its source; or
- a trust if (A) a court within the United States is able to exercise primary supervision over the administration of the trust and one or more “United States persons” (as defined in Section 7701(a)(30) of the Code) have the authority to control all substantial decisions of the trust, or (B) it has in effect under applicable U.S. Treasury Regulations a valid election to be treated as a United States person.

Moreover, the discussion below is based upon the provisions of the Code, the U.S. Treasury Regulations promulgated thereunder, and administrative and judicial interpretations thereof, all as of the date hereof. Those authorities may be repealed, revoked, modified, or subject to differing interpretations, possibly on a retroactive basis, which may result in U.S. federal income tax consequences different from those discussed below. Furthermore, this discussion does not address any aspect of U.S. federal non-income tax laws, such as gift or estate tax laws, or state, local, or non-U.S. tax laws, nor does this discussion address any alternative minimum tax considerations, any Medicare contribution tax considerations, or the special tax accounting rules under Section 451(b) of the Code.

This discussion does not consider the tax treatment of partnerships or other pass-through entities or persons that hold Summit Securities, or will hold YS Biopharma Securities, through such entities. If a partnership (or other entity or arrangement classified as a partnership for U.S. federal income tax purposes) is the owner of Summit Securities or YS Biopharma Securities, the U.S. federal income tax treatment of the partnership or a partner in the partnership generally will depend on the status of the partner and the activities of the partner and the partnership. U.S. Holders that are such a partnership or a partner of such a partnership should consult their tax advisors regarding the tax consequences in their particular circumstances.

THIS SUMMARY DOES NOT PURPORT TO BE A COMPREHENSIVE ANALYSIS OR DESCRIPTION OF ALL POTENTIAL U.S. FEDERAL INCOME TAX CONSEQUENCES OF THE BUSINESS COMBINATION. U.S. HOLDERS SHOULD CONSULT THEIR TAX ADVISORS REGARDING THE PARTICULAR TAX CONSEQUENCES TO THEM OF THE BUSINESS COMBINATION, OF THE EXERCISE OF REDEMPTION RIGHTS WITH RESPECT TO SUMMIT PUBLIC SHARES, AND OF THE OWNERSHIP AND DISPOSITION OF YS BIOPHARMA SECURITIES AFTER THE BUSINESS COMBINATION, INCLUDING THE APPLICABILITY AND EFFECTS OF U.S. FEDERAL, STATE, LOCAL, AND NON-U.S. TAX LAWS.

#### ***Tax Treatment of the Mergers***

To qualify as a Reorganization, the Mergers must satisfy certain requirements, some of which are based on factual determinations, and actions or events after the Mergers could adversely affect such qualification. One such requirement is that the acquiring corporation, directly or indirectly through certain controlled corporations, either continue a significant line of the acquired corporation’s historic business or use a significant portion of the acquired corporation’s historic business assets in a business, in each case, within the meaning of U.S. Treasury Regulations Section 1.368-1(d). However, due to the absence of guidance bearing directly on how the above rules apply in the case of an acquisition of a corporation like Summit that holds primarily investment-type assets, the qualification of the Mergers as a Reorganization is subject to significant uncertainty, and is therefore not capable of being the subject of a representation regarding its tax treatment. The closing of the Business Combination is not conditioned upon the receipt of an opinion of counsel that the Mergers will qualify as a Reorganization, and neither Summit nor YS Biopharma intends to request a ruling from the IRS regarding the U.S. federal income tax treatment of the Mergers. Accordingly, no assurance can be given that the IRS will not treat the Mergers as taxable transactions and challenge the qualification of the Mergers as a Reorganization or that a court will not sustain such a challenge by the IRS. U.S. Holders of Summit Securities are urged to consult their tax advisors regarding the proper U.S. federal income tax treatment of the Mergers, including with respect to their qualification as a Reorganization.

If any requirement to qualify as a Reorganization is not met, the Mergers generally will be a taxable transaction for U.S. federal income tax purposes. A U.S. Holder of Summit Securities generally will recognize gain or loss

in an amount equal to the difference, if any, between the fair market value (as of the Closing Date) of the YS Biopharma Securities received by such U.S. Holder in the Mergers, over such U.S. Holder's aggregate tax basis in the Summit Securities surrendered by such U.S. Holder in the Mergers. Such gain or loss generally will be long-term capital gain or loss if such U.S. Holder held the Summit Securities for more than one year. Long-term capital gains of non-corporate U.S. Holders currently are eligible for preferential tax rates. Short-term capital gains are taxed at rates applicable to ordinary income. It is unclear, however, whether the redemption rights with respect to the Summit Public Shares may suspend the running of the applicable holding period for this purpose. The deductibility of capital losses is subject to certain limitations. A U.S. Holder's aggregate tax basis in the YS Biopharma Securities received by such U.S. Holder in the Mergers generally will be the fair market value of such YS Biopharma Securities on the date of receipt. A U.S. Holder's holding period in the YS Biopharma Securities received by such U.S. Holder in the Mergers generally will not include such U.S. Holder's holding period in the Summit Securities surrendered by such U.S. Holder in the Mergers.

Subject to the PFIC rules described below, if the Mergers were to qualify as a "reorganization" under Section 368(a) of the Code, as described above, a U.S. Holder generally would not recognize gain or loss on the exchange of Summit Securities for YS Biopharma Securities in the Mergers. Such U.S. Holder's aggregate tax basis in the YS Biopharma Securities received by such U.S. Holder in the Mergers generally would equal such U.S. Holder's aggregate tax basis in the Summit Securities surrendered by such U.S. Holder in the Mergers. Such U.S. Holder's holding period in the YS Biopharma Securities received by such U.S. Holder in the Mergers generally would include such U.S. Holder's holding period in the Summit Securities surrendered by such U.S. Holder in the Mergers.

U.S. Holders should consult their tax advisors regarding the tax consequences of the Mergers in their particular circumstances.

#### ***Redemption of Summit Public Shares***

Subject to the PFIC rules described below, in the event that a U.S. Holder's Summit Public Shares are redeemed pursuant to the redemption provisions described in this proxy statement/prospectus under "Description of YS Biopharma Securities — Redemption of Ordinary Shares," the U.S. federal income tax treatment of the redemption will depend on whether the redemption qualifies as a sale or exchange of the Summit Public Shares under Section 302 of the Code.

If the redemption qualifies as a sale or exchange of Summit Public Shares, the U.S. Holder generally will recognize gain or loss in an amount equal to the difference, if any, between the amount realized on the redemption and such U.S. Holder's adjusted tax basis in the redeemed Summit Public Shares. Any such gain or loss generally will be long-term capital gain or loss if the U.S. Holder's holding period in such Summit Public Shares exceeds one year. Long-term capital gains of non-corporate U.S. Holders currently are eligible for preferential tax rates. The deduction of capital losses is subject to certain limitations.

If the redemption does not qualify as a sale or exchange of Summit Public Shares, the U.S. Holder generally will be treated as receiving a corporate distribution. Such distribution generally will constitute a dividend for U.S. federal income tax purposes to the extent paid from current or accumulated earnings and profits (as determined under U.S. federal income tax principles). Distributions in excess of current and accumulated earnings and profits generally will constitute a return of capital that will be applied against and reduce (but not below zero) the U.S. Holder's adjusted tax basis in the redeemed Summit Public Shares. Any remaining excess will be treated as gain realized on the sale or other disposition of such Summit Public Shares. With respect to non-corporate U.S. Holders, subject to certain exceptions, dividends generally will be taxed at currently preferential rates, provided that (a) Summit Public Shares are readily tradable on an established securities market in the United States, (b) Summit is not treated as a PFIC at the time the dividend was paid or in the preceding taxable year, and (c) certain holding period and other requirements are met. It is unclear, however, whether the redemption rights with respect to the Summit Public Shares may suspend the applicable holding period before this purpose.

Whether a redemption qualifies as a sale or exchange generally will depend on the total number of Summit Public Shares treated as held by the U.S. Holder (including any shares constructively owned by the U.S. Holder described in the following paragraph) relative to all of the Summit Public Shares outstanding both before and after such redemption, taking into account other transactions occurring in connection with the redemption

(including the Business Combination). The redemption of Summit Public Shares generally will be treated as a sale or exchange (rather than as a corporate distribution) if such redemption (i) is “substantially disproportionate” with respect to the U.S. Holder, (ii) results in a “complete termination” of the U.S. Holder’s interest in Summit, or (iii) is “not essentially equivalent to a dividend” with respect to the U.S. Holder. These tests are explained more fully below.

In determining whether any of the tests above is satisfied, a U.S. Holder takes into account not only Summit Public Shares actually owned by such U.S. Holder, but also Summit Public Shares constructively owned by such U.S. Holder. A U.S. Holder may constructively own, in addition to shares owned directly, shares owned by certain related individuals and entities in which the U.S. Holder has an interest or that have an interest in such U.S. Holder, as well as any shares the U.S. Holder has a right to acquire by exercise of an option, which generally would include Summit Public Shares that could be acquired pursuant to the exercise of Summit Public Warrants. In order to meet the substantially disproportionate test, the percentage of outstanding Summit Public Shares that are entitled to vote on the election of directors and are actually and constructively owned by the U.S. Holder immediately following the redemption must, among other requirements, be less than 80 percent of the percentage of outstanding Summit Public Shares that are entitled to vote on the election of directors and are actually and constructively owned by the U.S. Holder immediately before the redemption. Because holders of Summit Public Shares are not entitled to vote on the election of directors prior to the completion of the Business Combination, Summit Public Shares may not be treated as voting shares for this purpose and, consequently, this substantially disproportionate test may not apply. There will be a complete termination of a U.S. Holder’s interest if either (i) all Summit Shares actually and constructively owned by the U.S. Holder are redeemed or (ii) all Summit Shares actually owned by the U.S. Holder are redeemed and the U.S. Holder is eligible to waive, and effectively waives in accordance with specific rules, the attribution of Summit Shares owned by certain family members and the U.S. Holder does not constructively own any other Summit Shares. The redemption will not be essentially equivalent to a dividend with respect to a U.S. Holder if it results in a “meaningful reduction” of the U.S. Holder’s proportionate interest in Summit.

Whether the redemption will result in a meaningful reduction in a U.S. Holder’s proportionate interest in Summit will depend on the particular facts and circumstances. The IRS, however, has indicated in a published ruling that even a small reduction in the proportionate interest of a small minority shareholder in a publicly held corporation who exercises no control over corporate affairs may constitute such a “meaningful reduction.”

If none of the foregoing tests is satisfied, the redemption will be treated as a corporate distribution and taxed in the manner described above.

After the application of those rules, any remaining tax basis of the U.S. Holder in the redeemed Summit Public Shares will be added to the U.S. Holder’s adjusted tax basis in its remaining Summit Public Shares, or, if it has none, to the U.S. Holder’s adjusted tax basis in its Summit Warrants or possibly in other Summit Shares constructively owned by the U.S. Holder.

U.S. Holders should consult their tax advisors regarding the tax consequences of a redemption of Summit Public Shares in their particular circumstances.

### ***Ownership and Disposition of YS Biopharma Securities***

#### ***Distributions on YS Biopharma Ordinary Shares***

Subject to the PFIC rules described below under “— Passive Foreign Investment Company Rules,” a U.S. Holder generally will be required to include in gross income as a dividend the amount of any distribution on YS Biopharma Ordinary Shares to the extent the distribution is paid out of YS Biopharma’s current or accumulated earnings and profits (as determined under U.S. federal income tax principles). Such dividends paid by YS Biopharma will be taxable to a corporate U.S. Holder at regular rates and will not be eligible for the dividends-received deduction generally allowed to domestic corporations in respect of dividends received from other domestic corporations. Distributions in excess of such earnings and profits generally will be applied against and reduce (but not below zero) the U.S. Holder’s adjusted tax basis in YS Biopharma Ordinary Shares and, to the extent in excess of such basis, will be treated as gain from the sale or exchange of such shares (see “—Gain or Loss on Sale or Other Taxable Disposition of YS Biopharma Securities” below). YS



Biopharma does not intend to provide calculations of its earnings and profits under U.S. federal income tax principles. A U.S. Holder should expect all distributions to be reported as dividends for U.S. federal income tax purposes.

With respect to non-corporate U.S. Holders, subject to certain exceptions, dividends on YS Biopharma Ordinary Shares generally will be taxed at currently preferential rates, provided that (a) either (i) YS Biopharma Ordinary Shares are readily tradable on an established securities market in the United States, or (ii) YS Biopharma is eligible for the benefits of a comprehensive tax treaty with the United States which the Secretary of Treasury of the United States determines is satisfactory for this purpose and which includes an exchange of information program, (b) YS Biopharma is not treated as a PFIC at the time the dividend was paid or in the preceding taxable year, and (c) certain holding period and other requirements are met. U.S. Treasury Department guidance indicates that Nasdaq (on which YS Biopharma intends to apply to list the YS Biopharma Ordinary Shares) will be considered an established securities market in the United States for this purpose. Even if YS Biopharma Ordinary Shares are listed on Nasdaq, however, there can be no assurance that YS Biopharma Ordinary Shares will be considered readily tradable. In the event YS Biopharma is deemed to be a PRC resident enterprise under the EIT Law, it may be eligible for the benefits of the Agreement Between the Government of the United States of America and the Government of the People's Republic of China for the Avoidance of Double Taxation and the Prevention of Tax Evasion with Respect to Taxes on Income (the "United States-PRC income tax treaty") (which the Secretary of Treasury of the United States has determined is satisfactory for this purpose), in which case dividends on YS Biopharma Ordinary Shares would be taxed at currently preferential rates. Such dividends received by non-corporate U.S. Holders will not be eligible for the dividends-received deduction generally allowed to corporations.

For United States foreign tax credit purposes, dividends on YS Biopharma Ordinary Shares generally will constitute foreign source passive category income for foreign tax credit purposes. In the event that YS Biopharma is deemed to be a PRC resident enterprise under the EIT Law, a U.S. Holder may be subject to PRC withholding taxes on dividends paid on YS Biopharma Ordinary Shares. A U.S. Holder may be eligible, subject to a number of complex limitations, to claim a foreign tax credit in respect of any foreign withholding taxes imposed on such dividends received. A U.S. Holder who does not elect to claim a foreign tax credit for foreign tax withheld may instead claim a deduction for United States federal income tax purposes in respect of such withholding, but only for a year in which such holder elects to do so for all creditable foreign income taxes. The rules governing the foreign tax credit are complex.

U.S. Holders should consult their tax advisors regarding the tax consequences of any distributions on YS Biopharma Ordinary Shares in their particular circumstances, including the availability of preferential tax rates and the application of the foreign tax credit rules.

#### ***Gain or Loss on Sale or Other Taxable Disposition of YS Biopharma Securities***

Subject to the PFIC rules described below under "— Passive Foreign Investment Company Rules," a U.S. Holder generally will recognize gain or loss on the sale or other taxable disposition of YS Biopharma Securities in an amount equal to the difference, if any, between the amount realized on the disposition and such U.S. Holder's adjusted tax basis in such YS Biopharma Securities. Any such gain or loss generally will be long-term capital gain or loss if the U.S. Holder's holding period in such YS Biopharma Securities exceeds one year. Long-term capital gains of non-corporate U.S. Holders currently are eligible for preferential tax rates. The deduction of capital losses is subject to certain limitations. Any such gain or loss generally will be domestic source gain or loss for foreign tax credit purposes. However, in the event that YS Biopharma is treated as a PRC resident enterprise under the EIT Law, and gain from the disposition of YS Biopharma Securities is subject to tax in the PRC, such gain may be treated as PRC source gain for foreign tax credit purposes under the United States-PRC income tax treaty. U.S. Holders are urged to consult their tax advisors regarding the tax consequences if a foreign tax is imposed on a disposition of YS Biopharma Securities, including the availability of foreign tax credits under their particular circumstances.

#### ***Exercise, Lapse, or Redemption of YS Biopharma Warrants***

Subject to the PFIC rules described below under "— Passive Foreign Investment Company Rules" and except as discussed below with respect to the cashless exercise of a warrant, a U.S. Holder generally will not recognize gain or loss upon the acquisition of a YS Biopharma Ordinary Share upon the exercise of a YS Biopharma

Warrant for cash. A U.S. Holder's adjusted tax basis in the YS Biopharma Ordinary Share received upon exercise of the YS Biopharma Warrant generally will be an amount equal to the sum of the U.S. Holder's adjusted tax basis in the YS Biopharma Warrant exchanged therefor and the exercise price. The U.S. Holder's holding period in the YS Biopharma Ordinary Share received upon exercise of the YS Biopharma Warrant generally will begin on the date following the date of exercise (or possibly the date of exercise) of the YS Biopharma Warrant and will not include the period during which the U.S. Holder held the YS Biopharma Warrant. If a YS Biopharma Warrant is allowed to lapse unexercised, a U.S. Holder generally will recognize a capital loss equal to such U.S. Holder's adjusted tax basis in the YS Biopharma Warrant. Such capital loss will be long-term capital loss if the U.S. Holder held the YS Biopharma Warrant for more than one year at the time of such lapse.

The tax consequences of a cashless exercise of a warrant are not clear under current law. Subject to the PFIC rules described below under “— Passive Foreign Investment Company Rules,” a cashless exercise of a warrant may not be taxable, either because the exercise is not a realization event or because the exercise is treated as a “recapitalization” for U.S. federal income tax purposes.

In either situation, a U.S. Holder's tax basis in the YS Biopharma Ordinary Share received generally would equal the U.S. Holder's adjusted tax basis in the YS Biopharma Warrant. If the cashless exercise is not treated as a realization event, it is unclear whether a U.S. Holder's holding period in the YS Biopharma Ordinary Share will commence on the date of exercise or the day following the date of exercise, but it generally will not include the period during which the U.S. Holder held the YS Biopharma Warrant. If the cashless exercise is treated as a recapitalization, the holding period of the YS Biopharma Ordinary Shares generally would include the period during which the U.S. Holder held the YS Biopharma Warrant.

It is also possible that a cashless exercise may be treated in part as a taxable exchange in which gain or loss would be recognized. In such event, a portion of the YS Biopharma Warrant to be exercised on a cashless basis could, for U.S. federal income tax purposes, be deemed to have been surrendered in consideration for the exercise price of the remaining YS Biopharma Warrants, which would be deemed to be exercised. For this purpose, a U.S. Holder may be deemed to have surrendered a number of YS Biopharma Warrants having an aggregate fair market value equal to the aggregate exercise price for the total number of YS Biopharma Warrants to be exercised. Subject to the PFIC rules described below under “— Passive Foreign Investment Company Rules,” the U.S. Holder generally would recognize capital gain or loss in an amount equal to the difference, if any, between (i) the fair market value of the YS Biopharma Ordinary Shares that would have been received in a regular exercise of the YS Biopharma Warrants deemed surrendered, net of the aggregate exercise price of such YS Biopharma Warrants and (ii) the U.S. Holder's tax basis in such YS Biopharma Warrants. In this case, a U.S. Holder's tax basis in the YS Biopharma Ordinary Shares received upon the cashless exercise would equal the U.S. Holder's adjusted tax basis in the YS Biopharma Warrants deemed exercised, plus (or minus) the gain (or loss) recognized on the cashless exercise. It is unclear, however, whether a U.S. Holder's holding period in the YS Biopharma Ordinary Shares received upon the cashless exercise would commence on the date of exercise or the day following the date of exercise, but it generally would not include the period during which the U.S. Holder held the YS Biopharma Warrants.

Due to the absence of authority on the U.S. federal income tax treatment of a cashless exercise of a warrant, there can be no assurance which, if any, of the alternative tax consequences and holding periods described above would be adopted by the IRS or a court. Accordingly, U.S. Holders should consult their tax advisors regarding the tax consequences of exercising YS Biopharma Warrants, including through a cashless exercise, in their particular circumstances.

#### ***Possible Constructive Distributions***

The terms of each YS Biopharma Warrant provide for an adjustment to the number of YS Biopharma Ordinary Shares for which the YS Biopharma Warrant may be exercised or to the exercise price of the YS Biopharma Warrant in certain events, as discussed in the section of this proxy statement/prospectus entitled “Description of YS Biopharma Securities — Warrants.” An adjustment that has the effect of preventing dilution generally is not taxable. A U.S. Holder of the YS Biopharma Warrants would, however, be treated as receiving a constructive distribution from YS Biopharma if, for example, the adjustment increases such U.S. Holder's proportionate interest in YS Biopharma's assets or earnings and profits (e.g., through an increase in the number of YS Biopharma Ordinary Shares that would be obtained upon exercise or through a decrease to

the exercise price of a YS Biopharma Warrant) as a result of a distribution of cash or other property to the holders of YS Biopharma Ordinary Shares that is taxable to U.S. Holders of YS Biopharma Ordinary Shares as described under “— Distributions on YS Biopharma Ordinary Shares” above. Such constructive distribution would be subject to tax as described under that section in the same manner as if the U.S. Holder received a cash distribution from YS Biopharma equal to the fair market value of such increased interest, and would increase the U.S. Holder’s adjusted tax basis in its YS Biopharma Warrants to the extent that such distribution is treated as a dividend for U.S. federal income tax purposes. U.S. Holders should consult their tax advisors regarding the tax consequences of possible constructive distributions in their particular circumstances.

#### *Passive Foreign Investment Company Rules*

The U.S. federal income consequences could be materially different from those described above if Summit or YS Biopharma is or was treated as a PFIC for U.S. federal income tax purposes.

#### *Definition of a PFIC*

For any taxable year, a non-U.S. corporation generally will be classified as a PFIC for U.S. federal income tax purposes if either (i) at least 75% of its gross income for such taxable year is passive income or (ii) at least 50% of its assets (based on an average of the quarterly values of the assets) during such taxable year produce or are held for the production of passive income. Passive income generally includes dividends, interest, rents and royalties (other than rents or royalties derived from the active conduct of a trade or business) and gains from the disposition of passive assets. For purposes of the above calculations, a non-U.S. corporation that directly or indirectly owns at least 25% by value of the shares of another corporation is treated as holding and receiving directly its proportionate share of income and assets of such corporation.

#### *PFIC Status of Summit*

Because Summit is a blank-check company with no current active business, based on the composition of Summit’s income and assets, Summit believes it would qualify as a PFIC for its taxable year ending December 31, 2021, and unless the start-up exception applies, would likely qualify as a PFIC for its taxable year ending December 31, 2022. Pursuant to the start-up exception, a non-U.S. corporation will not be a PFIC for the first taxable year in which such corporation has gross income (the “start-up year”) if (i) no predecessor of such corporation was a PFIC, (ii) it is established to the satisfaction of the IRS that such corporation will not be a PFIC for either of the first two taxable years following the start-up year, and (iii) such corporation is not in fact a PFIC for either of those taxable years.

#### *PFIC Status of YS Biopharma*

Based on the expected income, assets, and operations of YS Biopharma and its subsidiaries, YS Biopharma does not expect to be a PFIC in the taxable year that includes the Business Combination, although there can be no assurance in this regard. The determination of whether YS Biopharma is a PFIC is made on an annual basis and will depend on the composition of income and assets of YS Biopharma and its subsidiaries, and the value of the assets of YS Biopharma and its subsidiaries, from time to time. The calculation of the value of the assets of YS Biopharma and its subsidiaries will be based, in part, on the quarterly market value of YS Biopharma Ordinary Shares, which is subject to change and may be volatile. The determination of whether YS Biopharma is a PFIC also will depend, in part, on how, and how quickly, it uses its liquid assets and cash, including the cash acquired from Summit in the Business Combination. If YS Biopharma were to retain significant amounts of liquid assets, including cash, the risk of YS Biopharma being classified as a PFIC may substantially increase. Because there are uncertainties in the application of the relevant rules and PFIC status is a factual determination made annually after the close of each taxable year, there can be no assurance that YS Biopharma will not be a PFIC for the taxable year that includes the Business Combination or any future taxable year, and no opinion of counsel has or will be provided regarding the classification of YS Biopharma as a PFIC.

#### *Application of PFIC Rules to Summit Securities and YS Biopharma Securities*

If Summit or YS Biopharma is classified as a PFIC for any taxable year during which a U.S. Holder held Summit Public Shares or YS Biopharma Ordinary Shares, Summit or YS Biopharma, as applicable, would

continue to be treated as a PFIC with respect to such investment unless (i) it ceased to be a PFIC and (ii) the U.S. Holder made a purging election with respect to its Summit Public Shares or YS Biopharma Ordinary Shares, as applicable. Under one type of purging election, the U.S. Holder will be deemed to have sold such shares at their fair market value and any gain recognized on such deemed sale will be treated as an excess distribution, as described below. As a result of such purging election, the U.S. Holder will have additional tax basis (to the extent of any gain recognized on such deemed sale) and, solely for purposes of the PFIC rules, a new holding period in such shares. U.S. Holders should consult their advisors regarding the application of the purging election rules in their particular circumstances.

If Summit or YS Biopharma is determined to be a PFIC for any taxable year during which a U.S. Holder held Summit Public Shares or YS Biopharma Ordinary Shares, as applicable, such U.S. Holder generally would be subject to special and adverse rules with respect to (i) any gain recognized by such U.S. Holder on the sale or other taxable disposition of its Summit Public Shares or YS Biopharma Ordinary Shares, as applicable, and (ii) any “excess distribution” made to such U.S. Holder (generally, any distributions to such U.S. Holder during a taxable year of the U.S. Holder that are greater than 125% of the average annual distributions received by such U.S. Holder in respect of Summit Public Shares or YS Biopharma Ordinary Shares, as applicable, during the three preceding taxable years or, if shorter, such U.S. Holder’s holding period in the Summit Public Shares or for the YS Biopharma Ordinary Shares, as applicable).

Under these rules:

- the U.S. Holder’s gain or excess distribution will be allocated ratably over the U.S. Holder’s holding period in the Summit Public Shares or YS Biopharma Ordinary Shares, as applicable;
- the amount allocated to the U.S. Holder’s taxable year in which the U.S. Holder recognized the gain or received the excess distribution, or to the period in the U.S. Holder’s holding period before the first day of the first taxable year of Summit or YS Biopharma, as applicable, in which Summit or YS Biopharma, as applicable, was a PFIC, will be taxed as ordinary income;
- the amount allocated to each other taxable year of the U.S. Holder and included in its holding period will be taxed at the highest tax rate in effect for such taxable year and applicable to the U.S. Holder; and
- an additional tax equal to the interest charge generally applicable to underpayments of tax will be imposed on the U.S. Holder with respect to the tax attributable to each such other taxable year of the U.S. Holder.

If YS Biopharma is a PFIC and, at any time, has a non-U.S. subsidiary that is classified as a PFIC, a U.S. Holder generally would be deemed to own a portion of the shares of such lower-tier PFIC, and generally could incur liability for the deferred tax and interest charge described above if YS Biopharma (or a subsidiary of YS Biopharma) receives a distribution from, or disposes of all or part of its interest in, the lower-tier PFIC or the U.S. Holders otherwise were deemed to have disposed of an interest in the lower-tier PFIC. U.S. Holders should consult their tax advisors regarding the tax issues raised by lower-tier PFICs.

#### *Application of the PFIC Rules to the Mergers*

Section 1291(f) of the Code requires that, to the extent provided in U.S. Treasury Regulations, a U.S. Holder that disposes of stock of a PFIC recognizes gain notwithstanding any other provision of the Code. No final U.S. Treasury Regulations are currently in effect under Section 1291(f) of the Code. However, proposed U.S. Treasury Regulations under Section 1291(f) of the Code have been promulgated with a retroactive effective date. If such proposed Treasury Regulations are finalized in their current form or if the IRS successfully asserts that Section 1291(f) of the Code is self-executing notwithstanding the absence of final or temporary U.S. Treasury Regulations, then if Summit is a PFIC, a U.S. Holder of Summit Public Shares may recognize gain in connection with the Mergers if: (i) such U.S. Holder did not make a timely “qualified electing fund” (“QEF”) election or mark-to-market election for Summit’s first taxable year as a PFIC in which such U.S. Holder held (or was deemed to hold) Summit Public Shares, or a QEF election along with an applicable purging election, and (ii) YS Biopharma is not a PFIC in the taxable year that includes the day after the closing date of the Mergers. Any such gain generally would be subject to the rules described above in “— Application of PFIC Rules to Summit Securities and YS Biopharma Securities.”

It is difficult to predict whether, in what form, and with what effective date, final U.S. Treasury Regulations under Section 1291(f) of the Code will be adopted and whether the IRS would assert that Section 1291(f) of

the Code is self-executing notwithstanding the absence of final or temporary U.S. Treasury Regulations. Therefore, U.S. Holders of Summit Public Shares that have not made a timely QEF election or mark-to-market election may, pursuant to the proposed U.S. Treasury Regulations, be subject to taxation under the PFIC rules on the Mergers to the extent their Summit Public Shares have a fair market value in excess of their adjusted tax basis therein.

The application of the PFIC rules to the Summit Public Warrants is unclear. A proposed U.S. Treasury Regulation issued under the PFIC rules (that has a 1992 effective date) generally treats an “option” to acquire the stock of a PFIC as stock of the PFIC, while a final U.S. Treasury Regulation issued under the PFIC rules provides that the holder of an option is not entitled to make a QEF election or mark-to-market election with respect to the option. It is possible that the proposed U.S. Treasury Regulations under Section 1291(f) of the Code (if finalized in their current form) may apply to cause gain recognition under the PFIC rules on the exchange of Summit Public Warrants for YS Biopharma Warrants pursuant to the Mergers.

*QEF and Mark-to-Market Elections Available to U.S. Holders of YS Biopharma Securities*

In general, a U.S. Holder may avoid the adverse PFIC tax consequences described above in respect of the YS Biopharma Ordinary Shares (but not YS Biopharma Warrants) by making and maintaining a timely and valid QEF election (if eligible to do so) to include in income its pro rata share of the net capital gains (as long-term capital gain) and other earnings and profits (as ordinary income) of YS Biopharma on a current basis, whether or not distributed, in the taxable year of the U.S. Holder in which the taxable year of YS Biopharma ends. To comply with the requirements of a QEF election, a U.S. Holder must receive a PFIC Annual Information Statement from YS Biopharma. YS Biopharma intends to provide the information necessary for a U.S. Holder to make and maintain a QEF election with respect to YS Biopharma Ordinary Shares for the taxable year that includes the Business Combination and the following taxable year if YS Biopharma determines that it is a PFIC for such taxable year, but may not make such information available in subsequent taxable years even if it determines that it is a PFIC for such subsequent taxable year.

The QEF election is made on a shareholder-by-shareholder basis and, once made, can be revoked only with the consent of the IRS. A U.S. Holder generally makes a QEF election by attaching a completed IRS Form 8621 (Information Return by a Shareholder of a Passive Foreign Investment Company or Qualified Electing Fund), including the information provided in a PFIC Annual Information Statement, to a timely filed U.S. federal income tax return for the taxable year to which the election relates. Retroactive QEF elections generally may be made only by filing a protective statement with such return and if certain other conditions are met or with the consent of the IRS. U.S. Holders should consult their tax advisors regarding the availability and tax consequences of a retroactive QEF election in their particular circumstances.

A QEF election may not be made with respect to warrants. As a result, if a U.S. Holder sells or otherwise disposes of YS Biopharma Warrants (other than upon exercise of such YS Biopharma Warrants for cash) and YS Biopharma, as applicable, was a PFIC for any taxable year during which the U.S. Holder held such YS Biopharma Warrants, any gain recognized generally will be treated as an excess distribution, taxed as described above. If a U.S. Holder that exercises YS Biopharma Warrants properly makes and maintains a QEF election with respect to the newly acquired YS Biopharma Ordinary Shares (or has previously made a QEF election with respect to YS Biopharma Ordinary Shares, as applicable), the QEF election will apply to the newly acquired YS Biopharma Ordinary Shares. Notwithstanding such QEF election, the adverse tax consequences relating to PFIC shares, adjusted to take into account the current income inclusions resulting from the QEF election, will continue to apply with respect to such newly acquired YS Biopharma Ordinary Shares (which generally will be deemed to have a holding period for purposes of the PFIC rules that includes the period during which the U.S. Holder held the YS Biopharma Warrants), unless the U.S. Holder makes a purging election, as described above.

Alternatively, if YS Biopharma is classified as a PFIC and YS Biopharma Ordinary Shares constitute “marketable stock,” a U.S. Holder may avoid the adverse PFIC tax consequences discussed above if such U.S. Holder, at the close of the first taxable year in which it holds (or is deemed to hold) YS Biopharma Ordinary Shares, makes a mark-to-market election with respect to such shares for such taxable year. Such U.S. Holder generally will include for each of its taxable years as ordinary income the excess, if any, of the fair market value of its YS Biopharma Ordinary Shares at the end of such taxable year, over its adjusted tax basis in its YS Biopharma Ordinary Shares. The U.S. Holder also will recognize an ordinary loss in respect of the excess, if

any, of its adjusted tax basis of its YS Biopharma Ordinary Shares, over the fair market value of its YS Biopharma Ordinary Shares at the end of its taxable year (but only to the extent of the net amount of previously included income as a result of the mark-to-market election). The U.S. Holder's adjusted tax basis in its YS Biopharma Ordinary Shares will be adjusted to reflect any such income or loss amounts, and any further gain recognized on a sale or other taxable disposition of its YS Biopharma Ordinary Shares will be treated as ordinary income. Currently, a mark-to-market election may not be made with respect to warrants. Moreover, a mark-to-market election made with respect to YS Biopharma Ordinary Shares would not apply to a U.S. Holder's indirect interest in any lower-tier PFICs in which YS Biopharma owns shares.

The mark-to-market election is available only for "marketable stock," generally, stock that is regularly traded on a national securities exchange that is registered with the SEC, including Nasdaq (on which YS Biopharma Ordinary Shares will be listed), or on a foreign exchange or market that the IRS determines has rules sufficient to ensure that the market price represents a legitimate and sound fair market value.

U.S. Holders should consult their tax advisors regarding the availability and tax consequences of a QEF election or a mark-to-market election in their particular circumstances.

A U.S. Holder that owns (or is deemed to own) shares in a PFIC during any taxable year of the U.S. Holder may have to file an IRS Form 8621 and such other information as may be required by the U.S. Treasury Department. Failure to do so, if required, will extend the statute of limitations until such required information is furnished to the IRS.

The PFIC rules are very complex and are affected by various factors in addition to those described above. Accordingly, U.S. Holders should consult their tax advisors regarding the application of the PFIC rules in their particular circumstances.

#### ***Information Reporting and Backup Withholding Applicable to U.S. Holders of YS Biopharma Securities***

Dividend payments (including constructive dividends) with respect to YS Biopharma Ordinary Shares and proceeds from the sale, exchange, or redemption of YS Biopharma Securities may be subject to information reporting to the IRS and possible United States backup withholding. Backup withholding will not apply, however, to a U.S. Holder that furnishes a correct taxpayer identification number (generally on an IRS Form W-9) and makes other required certifications, or that is otherwise exempt from backup withholding and establishes such exempt status. Backup withholding is not an additional tax. Any amounts withheld under the backup withholding rules may be allowed as a refund or credit against a U.S. Holder's U.S. federal income tax liability, provided that the required information is timely furnished to the IRS. U.S. Holders should consult their tax advisors regarding any required information reporting and the application of the backup withholding rules in their particular circumstances.

Certain U.S. Holders are required to report information to the IRS relating to an interest in "specified foreign financial assets," including shares issued by a non-United States corporation, for any year in which the aggregate value of all specified foreign financial assets exceeds \$50,000 (or a higher dollar amount prescribed by the IRS), subject to certain exceptions (including an exception for shares held in custodial accounts maintained with a United States financial institution). These rules also impose penalties if a U.S. Holder is required to submit such information to the IRS and fails to do so. U.S. Holders should consult their own tax advisers regarding the application of these reporting requirements.

THE U.S. FEDERAL INCOME TAX DISCUSSION SET FORTH ABOVE IS INCLUDED FOR GENERAL INFORMATION ONLY AND IS NOT TAX ADVICE. U.S. HOLDERS SHOULD CONSULT THEIR TAX ADVISORS REGARDING THE U.S. FEDERAL, STATE, AND LOCAL AND NON-U.S. INCOME AND NON-INCOME TAX CONSEQUENCES OF THE BUSINESS COMBINATION, OF THE EXERCISE OF REDEMPTION RIGHTS WITH RESPECT TO SUMMIT PUBLIC SHARES, AND OF THE OWNERSHIP AND DISPOSITION OF YS BIOPHARMA SECURITIES AFTER THE BUSINESS COMBINATION, INCLUDING THE IMPACT OF ANY ACTUAL OR POTENTIAL CHANGE IN TAX LAW.

#### **Cayman Islands Tax Considerations**

Prospective investors should consult their professional advisers on the possible tax consequences of buying, holding or selling shares under the laws of their country of citizenship, residence or domicile.

The following is a discussion on certain Cayman Islands income tax consequences of an investment in the YS Biopharma Ordinary Shares. The discussion is a general summary of present law, which is subject to prospective and retroactive change. It is not intended as tax advice, does not consider any investor's particular circumstances, and does not consider tax consequences other than those arising under Cayman Islands law.

*Under Existing Cayman Islands Laws:*

YS Biopharma has been incorporated under the laws of the Cayman Islands as an exempted company with limited liability and, as such, has obtained an undertaking from the Governor in Cabinet of the Cayman Islands in the following form:

*The Tax Concessions Act*

*Undertaking as to Tax Concessions*

In accordance with the Tax Concessions Act (As Revised) of the Cayman Islands, the Governor in Cabinet undertakes with YS Biopharma:

- (a) That no law which is hereafter enacted in the Cayman Islands imposing any tax to be levied on profits, income, gains or appreciations shall apply to YS Biopharma or its operations; and
- (b) In addition, that no tax to be levied on profits, income, gains or appreciations or which is in the nature of estate duty or inheritance tax shall be payable:
  - (i) on or in respect of the shares, debentures or other obligations of YS Biopharma; or
  - (ii) by way of the withholding in whole or part, of any relevant payment as defined in the Tax Concessions Act (As Revised).

These concessions shall be for a period of TWENTY years from the date hereof.

The Cayman Islands currently levy no taxes on individuals or corporations based upon profits, income, gains or appreciations and there is no taxation in the nature of inheritance tax or estate duty. There are no other taxes likely to be material to YS Biopharma levied by the Government of the Cayman Islands except for certain stamp duties which may be applicable on certain instruments executed in or brought within the jurisdiction of the Cayman Islands. There are no foreign exchange controls or foreign exchange regulations or currency restrictions in the Cayman Islands.

**Material PRC Tax Considerations**

***Business Combination***

The SAT Bulletin 7 stipulates that if a non-resident enterprise indirectly transfers its equity interests in, or other assets of, a PRC resident enterprise without any reasonable business purpose in order to evade PRC enterprise income tax obligations, such indirect transfer will be re-characterized under the PRC Enterprise Income Tax Law as a direct transfer of such equity interests or other assets of the Chinese resident enterprise and will be subject to PRC withholding tax with respect to gain deemed to have resulted from such transfer. SAT Bulletin 7 could apply if the Business Combination did not have a reasonable business purpose and was being carried out in order to evade PRC corporate income tax obligations. Although we believe that SAT Bulletin 7 does not apply to the Business Combination, it is possible that PRC tax authorities would make an assessment that the Business Combination is subject to SAT Bulletin 7. If SAT Bulletin 7 were to apply to the Business Combination, there would be PRC 10% withholding tax imposed on any gain deemed, from a PRC tax perspective, to have been realized from the Business Combination.

***Taxation following the consummation of the Business Combination***

Under the EIT Law and its implementation rules, an enterprise established outside of China with a "de facto management body" within China is considered a resident enterprise and will be subject to the enterprise income tax at the rate of 25% on its global income. The implementation rules define the term "de facto management body" as the body that exercises full and substantial control over and overall management of the

business, productions, personnel, accounts and properties of an enterprise. In April 2009, SAT issued the Circular 82, which provides certain specific criteria for determining whether the “de facto management body” of a PRC-controlled enterprise that is incorporated offshore is located in China. Although the Circular 82 only applies to offshore enterprises controlled by PRC enterprises or PRC enterprise groups, not those controlled by PRC individuals or foreigners, the criteria set forth in the Circular 82 may reflect the general position of SAT on how the “de facto management body” test should be applied in determining the tax resident status of all offshore enterprises. According to the Circular 82, an offshore incorporated enterprise controlled by a PRC enterprise or a PRC enterprise group will be regarded as a PRC tax resident by virtue of having its “de facto management body” in China only if all of the following conditions are met: (1) the primary location of the day-to-day operational management to perform their duties is in China; (2) decisions relating to the enterprise’s financial and human resource matters are made or are subject to approval by organizations or personnel in China; (3) the enterprise’s primary assets, accounting books and records, company seals, and board and shareholder resolutions, are located or maintained in China; and (4) at least 50% of voting board members or senior executives habitually reside in China.

We do not believe that YS Biopharma, a Cayman Islands holding company meets all of the conditions above following the consummation of the Business Combination. It is not a PRC resident enterprise for PRC tax purposes. As a holding company, its key assets are its ownership interests in its subsidiaries, and its key assets are located, and its records (including the resolutions of its board of directors and the resolutions of its shareholders) are maintained, outside China. For the same reasons, we believe other YS Biopharma’s subsidiaries outside of China are not PRC resident enterprises either. However, the tax resident status of an enterprise is subject to determination by the PRC tax authorities and uncertainties remain with respect to the interpretation of the term “de facto management body.” There can be no assurance that the PRC government will ultimately take a view that is consistent with ours.

Jingtian & Gongcheng, YS Biopharma’s legal counsel as to the PRC law, has advised YS Biopharma that if the PRC tax authorities determine that YS Biopharma, a Cayman Islands holding company, is a PRC resident enterprise for enterprise income tax purposes, YS Biopharma may be required to withhold a 10% withholding tax from dividends it pays to its security holders that are non-resident enterprises, including the holders of the ordinary shares and warrants. In addition, non-resident enterprise shareholders (including the holders of ordinary shares and warrants) may be subject to a 10% PRC tax on gains realized on the sale or other disposition of such securities, if such income is treated as sourced from within China. It is unclear whether YS Biopharma’s non-PRC individual shareholders (including the holders of ordinary shares and warrants) would be subject to any PRC tax on dividends or gains obtained by such non-PRC individual shareholders in the event it is determined to be a PRC resident enterprise. If any PRC tax were to apply to such dividends or gains, it would generally apply at a rate of 20% unless a reduced rate is available under an applicable tax treaty. However, it is also unclear whether non-PRC shareholders of YS Biopharma would be able to claim the benefits of any tax treaties between their country of tax residence and China in the event that YS Biopharma is treated as a PRC resident enterprise.

Provided that YS Biopharma is not deemed to be a PRC resident enterprise, holders of its securities (including ordinary shares and warrants) who are not PRC residents will not be subject to PRC income tax on dividends distributed by it or gains realized from the sale or other disposition of its securities. However, under SAT Bulletin 7, where a non-resident enterprise conducts an “indirect transfer” by transferring taxable assets, including, in particular, equity interests in a PRC resident enterprise, indirectly by disposing of the equity interests of an overseas holding company, the non-resident enterprise, being the transferor, or the transferee or the PRC entity which directly owned such taxable assets may report to the relevant tax authority such indirect transfer. Using a “substance over form” principle, the PRC tax authority may disregard the existence of the overseas holding company if it lacks a reasonable commercial purpose and was established for the purpose of reducing, avoiding or deferring PRC tax. As a result, gains derived from such indirect transfer may be subject to PRC enterprise income tax, and the transferee obligated to withhold the applicable taxes, currently at a rate of 10% for the transfer of equity interests in a PRC resident enterprise. YS Biopharma and its non-PRC resident investors may be at risk of being required to file a return and being taxed under SAT Bulletin 7, and YS Biopharma may be required to expend valuable resources to comply with SAT Bulletin 7, or to establish that it should not be taxed thereunder. See the section entitled “Risk Factors — Risks Related to Conducting Business in China.”



## DESCRIPTION OF YS BIOPHARMA SECURITIES

A summary of the material provisions governing YS Biopharma's share capital immediately following consummation of the Business Combination is described below. This summary is not complete and should be read together with the Amended YS Biopharma Articles, a copy of which is appended to this proxy statement/prospectus as **Annex B**.

YS Biopharma is a Cayman Islands exempted company with limited liability and immediately following consummation of the Business Combination its affairs will be governed by the Amended YS Biopharma Articles, the Cayman Islands Companies Act, and the common law of the Cayman Islands.

Immediately following consummation of the Business Combination, YS Biopharma's authorized share capital will be \$50,000 divided into 2,500,000,000 ordinary shares of \$0.00002 par value each. All YS Biopharma Ordinary Shares issued and outstanding at the consummation of the Business Combination will be fully paid and non-assessable.

The Amended YS Biopharma Articles will become effective at the Merger Effective Time. The following are summaries of material provisions of the Amended YS Biopharma Articles and the Cayman Islands Companies Act insofar as they relate to the material terms of the YS Biopharma Ordinary Shares.

### **Ordinary Shares**

#### ***General***

Holders of YS Biopharma Ordinary Shares have the same rights. All of the YS Biopharma Ordinary Shares are fully paid and non-assessable. Shareholders of YS Biopharma who are non-residents of the Cayman Islands may freely hold and transfer their ordinary shares.

#### ***Dividends***

The holders of YS Biopharma Ordinary Shares are entitled to such dividends as may be declared by the board of directors of YS Biopharma. In addition, YS Biopharma shareholders may declare dividends by ordinary resolution, but no dividend shall exceed the amount recommended by the board of directors of YS Biopharma. The Amended YS Biopharma Articles provide that the directors of YS Biopharma may, before recommending or declaring any dividend, set aside out of the funds legally available for distribution such sums as they think proper as a reserve or reserves which shall, in the absolute discretion of the directors, be applicable for meeting contingencies or for equalizing dividends or for any other purpose to which those funds may be properly applied. Under the laws of the Cayman Islands, YS Biopharma may pay a dividend out of either profit or share premium account, provided that in no circumstances may a dividend be paid if this would result in YS Biopharma being unable to pay its debts as they fall due in the ordinary course of business.

#### ***Voting Rights***

In respect of all matters subject to a shareholders' vote, each ordinary share is entitled to one vote. Voting at any meeting of shareholders is by show of hands unless a poll is (before or on the declaration of the result of the show of hands) demanded. A poll may be demanded by the chair person of such meeting or any one or more shareholders holding not less than ten per cent (10%) of the votes attaching to the YS Biopharma Ordinary Shares present in person or by proxy entitled to vote. An ordinary resolution to be passed at a meeting by the shareholders requires the affirmative vote of a simple majority of the votes attaching to the ordinary shares cast at a meeting, while a special resolution requires the affirmative vote of no less than two-thirds of the votes cast attaching to the issued and outstanding ordinary shares at a meeting and includes a unanimous written resolution. A special resolution will be required for important matters such as a change of name, reducing the share capital or making changes to the Amended YS Biopharma Articles.

#### ***Transfer of Ordinary Shares***

Subject to the restrictions contained in the Amended YS Biopharma Articles, any of YS Biopharma shareholders may transfer all or any of his or her ordinary shares by an instrument of transfer in the usual or common form or any other form approved by the YS Biopharma board of directors.

The YS Biopharma board of directors may, in its absolute discretion, decline to register any transfer of any ordinary share which is not fully paid up or on which it have a lien. The YS Biopharma board of directors may also decline to register any transfer of any ordinary share unless:

- the instrument of transfer is lodged with YS Biopharma, accompanied by the certificate for the shares to which it relates (if any) and such other evidence as the board of directors of YS Biopharma may reasonably require to show the right of the transferor to make the transfer;
- the instrument of transfer is in respect of only one class of shares;
- the instrument of transfer is properly stamped, if required;
- in the case of a transfer to joint holders, the number of joint holders to whom the share is to be transferred does not exceed four; or
- a fee of such maximum sum as Nasdaq may determine to be payable, or such lesser sum as the board of directors of YS Biopharma may from time to time require, is paid to YS Biopharma in respect thereof.

If the YS Biopharma directors refuse to register a transfer, they shall, within three calendar months after the date on which the instrument of transfer was lodged with YS Biopharma, send to each of the transferor and the transferee notice of such refusal.

The registration of transfers may, after compliance with any notice required of the NYSE, be suspended and the register of members closed at such times and for such periods as its board of directors may, in their absolute discretion, from time to time determine, provided, always that the registration of transfers shall not be suspended nor the register of members closed for more than 30 days in any calendar year.

### ***Liquidation***

On a return of capital on winding-up or otherwise (other than on conversion, redemption or purchase of ordinary shares), assets available for distribution among the holders of ordinary shares shall be more than sufficient to repay the whole of the share capital at the commencement of the winding up, the surplus shall be distributed amongst the YS Biopharma shareholders in proportion to the par value of the YS Biopharma Ordinary Shares held by them at the commencement of the winding up subject to a deduction from those YS Biopharma Ordinary Shares in respect of which there are monies due. If its assets available for distribution are insufficient to repay all of the paid-up capital, the assets will be distributed so that as nearly as may be, the losses shall be borne by the YS Biopharma shareholders in proportion to the par value of the YS Biopharma Ordinary Shares held by them.

### ***Calls on Ordinary Shares and Forfeiture of Ordinary Shares***

The board of directors of YS Biopharma may from time to time make calls upon shareholders for any amounts unpaid on their YS Biopharma Ordinary Shares (subject to receiving at least fourteen calendar days' notice specifying the time or times of payment). The YS Biopharma Ordinary Shares that have been called upon and remain unpaid are, after a notice period, subject to forfeiture.

### ***Redemption of Ordinary Shares***

Subject to the provisions of the Cayman Islands Companies Act, YS Biopharma may issue shares that are to be redeemed or are liable to be redeemed at the option of the shareholder or YS Biopharma. The redemption of such shares will be effected in such manner and upon such other terms as YS Biopharma may, by either resolution of the board of directors of YS Biopharma or special resolution of shareholders, determine before the issue of the shares. YS Biopharma may also repurchase any YS Biopharma Ordinary Shares on such terms and in such manner as have been approved by the board of directors of YS Biopharma or by an ordinary resolution of the YS Biopharma shareholders.

Under the Cayman Islands Companies Act, the redemption or repurchase of any share may be paid out of the company's profits or out of the proceeds of a fresh issue of shares made for the purpose of such redemption or repurchase, or out of capital (including share premium account and capital redemption reserve) if the company can, immediately following such payment, pay its debts as they fall due in the ordinary course of

business. In addition, under the Companies Act, no such share may be redeemed or repurchased (i) unless it is fully paid up, (ii) if such redemption or repurchase would result in there being no shares issued and outstanding, or (iii) if the company has commenced liquidation. In addition, the YS Biopharma directors may accept the surrender of any fully paid share for no consideration.

#### ***Variations of Rights of Shares***

All or any of the special rights attached to any class of shares may, subject to the provisions of the Cayman Islands Companies Act, be materially adversely varied with the consent in writing of the holders of not less than two-thirds of the issued shares of that class, or with the sanction of a resolution passed by at least a two-thirds majority of the holders of shares of the class present in person or by proxy at a separate general meeting of the holders of the shares of that class. The rights conferred upon the holders of the shares of any class issued shall not, unless otherwise expressly provided by the terms of issue of the shares of that class, be deemed to be materially adversely varied by or abrogated by, inter alia, the creation or allotment or issue of further shares ranking pari passu with or subsequent to such existing class of shares. The rights of the holders of YS Biopharma Ordinary Shares shall not be deemed to be materially adversely varied by the creation or issue of shares with preferred or other rights including, without limitation, the creation of shares with enhanced or weighted voting rights.

#### ***General Meetings of Shareholders***

Shareholders' meetings may be convened by the chairperson of YS Biopharma a majority of YS Biopharma's board of directors. Advance notice of at least seven (7) calendar days is required for the convening of its annual general shareholders' meeting and any other general meeting of its shareholders, provided that a general meeting of the Company shall be deemed to have been duly convened if it is so agreed by two-thirds of the shareholders (or their proxies) having a right to attend and vote at the meeting.

#### ***Voting Rights Attaching to the Shares.***

Subject to any rights and restrictions for the time being attached to any Share, on a show of hands every shareholder present in person and every person representing a shareholder by proxy shall, at a shareholders' meeting, each have one vote and on a poll every shareholder and every person representing a shareholder by proxy shall have one vote for each Share of which he or the person represented by proxy is the holder.

#### ***Inspection of Books and Records***

The board of directors of YS Biopharma will determine whether, to what extent, at what times and places and under what conditions or articles the accounts and books of YS Biopharma will be open to the inspection by YS Biopharma shareholders, and no YS Biopharma shareholder (not being a director of YS Biopharma) will otherwise have any right of inspecting any account or book or document of YS Biopharma except as required by the Cayman Islands Companies Act or authorized by ordinary resolution of YS Biopharma shareholders.

#### ***Changes in Capital***

YS Biopharma may from time to time by ordinary resolution:

- increase its share capital by such sum, to be divided into shares of such amount, as the resolution will prescribe;
- consolidate and divide all or any of its share capital into shares of a larger amount than existing shares;
- sub-divide its existing shares or any of them into shares of a smaller amount; provided that in the subdivision the proportion between the amount paid and the amount, if any, unpaid on each reduced share will be the same as it was in case of the share from which the reduced share is derived; or
- cancel any shares that at the date of the passing of the resolution have not been taken or agreed to be taken by any person and diminish the amount of its share capital by the amount of the shares so cancelled.

YS Biopharma may by special resolution, subject to any confirmation or consent required by the Companies Law, reduce its share capital or any capital redemption reserve in any manner permitted by law.

## Warrants

Upon the consummation of the Business Combination, each Summit Warrant outstanding immediately prior will cease to be a warrant with respect to Summit Public Shares and be assumed by YS Biopharma and converted into a YS Biopharma Warrant entitling the holder thereof to purchase such number of YS Biopharma Ordinary Share on a one-on-one basis. Each YS Biopharma Warrant will otherwise continue to have and be subject to substantially the same terms and conditions as were applicable to such Summit Warrant immediately prior to the consummation of the Business Combination (including any repurchase rights and cashless exercise provisions).

## Exempted Company

YS Biopharma is an exempted company with limited liability incorporated under the laws of Cayman Islands. The Cayman Islands Companies Act distinguishes between ordinary resident companies and exempted companies. Any company that is registered in the Cayman Islands but conducts business mainly outside of the Cayman Islands may apply to be registered as an exempted company. The requirements for an exempted company are essentially the same as for an ordinary resident company except for the exemptions and privileges listed below:

- an exempted company (other than an exempted company holding a license to carry on business in the Cayman Islands) does not have to file an annual return of its shareholders with the Registrar of Companies of the Cayman Islands;
- an exempted company's register of members is not open to inspection;
- an exempted company does not have to hold an annual general meeting;
- an exempted company may not issue negotiable or bearer shares, but may issue shares with no par value;
- an exempted company may obtain an undertaking against the imposition of any future taxation;
- an exempted company may register by way of continuation in another jurisdiction and be deregistered in the Cayman Islands;
- an exempted company may register as a limited duration company; and
- an exempted company may register as a segregated portfolio company.

"Limited liability" means that the liability of each shareholder is limited to the amount unpaid by the shareholder on the shares of the company (except in exceptional circumstances, such as involving fraud, the establishment of an agency relationship or an illegal or improper purpose or other circumstances in which a court may be prepared to pierce or lift the corporate veil).

## Data Protection in the Cayman Islands — Privacy Notice

This privacy notice explains the manner in which YS Biopharma collects, processes and maintains personal data about investors of the company pursuant to the Data Protection Act, 2017 of the Cayman Islands, as amended from time to time and any regulations, codes of practice or orders promulgated pursuant thereto ("DPA").

YS Biopharma is committed to processing personal data in accordance with the DPA. In its use of personal data, the company will be characterized under the DPA as a 'data controller', whilst certain of the company's service providers, affiliates and delegates may act as 'data processors' under the DPA. These service providers may process personal information for their own lawful purposes in connection with services provided to the company.

This privacy notice puts shareholders of YS Biopharma on notice that, by virtue of making an investment in YS Biopharma, YS Biopharma and certain of service providers of YS Biopharma may collect, record, store, transfer and otherwise process personal data by which individuals may be directly or indirectly identified.

Your personal data will be processed fairly and for lawful purposes, including (a) where the processing is necessary for the company to perform a contract to which you are a party or for taking pre-contractual steps

at your request (b) where the processing is necessary for compliance with any legal, tax or regulatory obligation to which the company is subject or (c) where the processing is for the purposes of legitimate interests pursued by the company or by a service provider to whom the data are disclosed. As a data controller, the YS Biopharma will only use your personal data for the purposes for which the YS Biopharma collected it. If the YS Biopharma need to use your personal data for an unrelated purpose, the YS Biopharma will contact you.

YS Biopharma anticipate that YS Biopharma will share your personal data with the company's service providers for the purposes set out in this privacy notice. YS Biopharma may also share relevant personal data where it is lawful to do so and necessary to comply with its contractual obligations or your instructions or where it is necessary or desirable to do so in connection with any regulatory reporting obligations. In exceptional circumstances, YS Biopharma will share your personal data with regulatory, prosecuting and other governmental agencies or departments, and parties to litigation (whether pending or threatened), in any country or territory including to any other person where YS Biopharma have a public or legal duty to do so (e.g. to assist with detecting and preventing fraud, tax evasion and financial crime or compliance with a court order).

Your personal data shall not be held by YS Biopharma for longer than necessary with regard to the purposes of the data processing.

YS Biopharma will not sell your personal data. Any transfer of personal data outside of the Cayman Islands shall be in accordance with the requirements of the DPA. Where necessary, the YS Biopharma will ensure that separate and appropriate legal agreements are put in place with the recipient of that data.

YS Biopharma will only transfer personal data in accordance with the requirements of the DPA, and will apply appropriate technical and organizational information security measures designed to protect against unauthorized or unlawful processing of the personal data and against the accidental loss, destruction or damage to the personal data.

If you are a natural person, this will affect you directly. If you are a corporate investor (including, for these purposes, legal arrangements such as trusts or exempted limited partnerships) that provides YS Biopharma with personal data on individuals connected to you for any reason in relation to your investment into the company, this will be relevant for those individuals and you should inform such individuals of the content.

You have certain rights under the DPA, including (a) the right to be informed as to how YS Biopharma collect and use your personal data (and this privacy notice fulfils the YS Biopharma obligation in this respect) (b) the right to obtain a copy of your personal data (c) the right to require YS Biopharma to stop direct marketing (d) the right to have inaccurate or incomplete personal data corrected (e) the right to withdraw your consent and require YS Biopharma to stop processing or restrict the processing, or not begin the processing of your personal data (f) the right to be notified of a data breach (unless the breach is unlikely to be prejudicial) (g) the right to obtain information as to any countries or territories outside the Cayman Islands to which the YS Biopharma, whether directly or indirectly, transfer, intend to transfer or wish to transfer your personal data, general measures YS Biopharma take to ensure the security of personal data and any information available to YS Biopharma as to the source of your personal data (h) the right to complain to the Office of the Ombudsman of the Cayman Islands and (i) the right to require YS Biopharma to delete your personal data in some limited circumstances.

If you consider that your personal data has not been handled correctly, or you are not satisfied with the company's responses to any requests you have made regarding the use of your personal data, you have the right to complain to the Cayman Islands' Ombudsman. The Ombudsman can be contacted by calling +1 (345) 946-6283 or by email at [info@ombudsman.ky](mailto:info@ombudsman.ky).

### **Registration Rights**

Certain persons who will be holders of YS Biopharma securities immediately after consummation of the Business Combination will be entitled to customary demand and piggyback registration rights pursuant to the Shareholder Support Agreement. See the section entitled "The Business Combination Agreement."

## COMPARISON OF CORPORATE GOVERNANCE AND SHAREHOLDER RIGHTS

This section describes the material differences between the rights of Summit Shareholders before the consummation of the Business Combination, and the rights of YS Biopharma shareholders after the Business Combination. These differences in shareholder rights result from the differences between the respective governing documents of Summit and YS Biopharma.

This section does not include a complete description of all differences among such rights, nor does it include a complete description of such rights. Furthermore, the identification of some of the differences of these rights as material is not intended to indicate that other differences that may be equally important do not exist. Summit Shareholders are urged to carefully read the Amended YS Biopharma Articles that will be in effect as of consummation of the Merger (which form is included as **Annex B** to this proxy statement/prospectus). References in this section to the Amended YS Biopharma Articles are references thereto as they will be in effect upon consummation of the Merger. However, the Amended YS Biopharma Articles may be amended at any time prior to its adoption by YS Biopharma shareholders prior to the consummation of the Business Combination by mutual agreement of Summit and YS Biopharma or after the consummation of the Business Combination by amendment in accordance with their terms. If the Amended YS Biopharma Articles are amended, the below summary may cease to accurately reflect the Amended YS Biopharma Articles as so amended.

Summit	YS Biopharma
<b>Authorized Share Capital</b>	
Summit's authorized share capital is \$55,500 divided into 500,000,000 Summit Public Shares of a par value of \$0.0001 each, 500,000,000 Founder Shares of a par value of \$0.0001 each and 5,000,000 preference shares of a par value of \$0.0001 each.	YS Biopharma's authorized share capital is \$50,000 divided into 2,500,000,000 shares of \$0.00002 par value each.
<b>Rights of Preference Shares</b>	
Subject to the Summit Articles, any direction that may be given by Summit Shareholders in general meeting and, where applicable, the rules and regulations of the Nasdaq, the SEC and/or any other competent regulatory authority or otherwise under applicable law, and without prejudice to any rights attached to any existing Summit Shares, the Summit Board may allot, issue, grant options over or otherwise dispose of Summit Shares with or without preferred, deferred or other rights or restrictions, whether in regard to dividends or other distributions, voting, return of capital or otherwise, provided the Summit Board shall not do any of the foregoing to the extent it may affect the ability of Summit to carry out the conversion of the Founder Shares into Summit Public Shares as set out in the Summit Articles.	Subject to the Amended YS Biopharma Articles, the directors may provide, out of unissued shares (other than authorized but unissued YS Biopharma Ordinary Shares), for series of preference shares and to establish the number of shares to constitute such series and any voting rights, powers, preferences and relative, participating, optional and other special rights, and any qualifications, limitations and restrictions of such series.
<b>Number and Qualification of Directors</b>	
Summit Shareholders may by ordinary resolution fix the maximum and minimum number of directors to be appointed to the Summit Board but unless such numbers are fixed, the minimum number of directors is one and the maximum number of directors is unlimited.	Unless otherwise determined by YS Biopharma shareholders by ordinary resolution, the number of directors shall not be less than three directors.
Directors will not be required to hold any shares in Summit unless and until such time that Summit	Directors will not be required to hold any shares in YS Biopharma.

**Summit****YS Biopharma**

Shareholders in a general meeting fix a minimum shareholding required to be held by a director.

**Election/Removal of Directors**

The directors may appoint any person to be a director, either to fill a vacancy or as an additional director, provided that the appointment does not cause the number of directors to exceed any number fixed by or in accordance with the Summit Articles as the maximum number of directors.

Summit Shareholders may appoint any person to be a director by ordinary resolution and may remove any director by ordinary resolution, provided that, prior to the closing of an initial business combination, only holders of Founder Shares will have the right to vote on the appointment and removal of directors. Prior to the closing of an initial business combination, holders of Summit Public Shares have no right to vote on the appointment or removal of directors.

**Cumulative Voting**

Holders of Summit Shares will not have cumulative voting rights.

YS Biopharma shareholders may by ordinary resolution appoint any person to be a director. The directors may, by the affirmative vote of a simple majority of the remaining directors present and voting at a board meeting, appoint any person to be a director so as to fill a casual vacancy or as an addition to the existing board of directors.

Holders of YS Biopharma Ordinary Shares will not have cumulative voting rights.

**Vacancies on the Board of Directors**

The office of any director shall be vacated if:

(a) such director resigns by notice in writing to Summit;

(b) such director absents himself (for the avoidance of doubt, without being represented by proxy or an alternate director appointed by him) from three consecutive meetings of the Summit Board without special leave of absence from the other directors, and the other directors pass a resolution that he has by reason of such absence vacated office;

(c) such director dies, becomes bankrupt or makes any arrangement or composition with his creditors generally;

(d) such director is found to be or becomes of unsound mind;

(e) all of the other directors (being not less than two in number) determine that such director should be removed as a director, either by a resolution passed by all of the other directors at a meeting of the directors duly convened and held in accordance with the Summit Articles or by a resolution in writing signed by all of the other directors; or

(f) the director is removed from office pursuant to any other provision of the Summit Articles, including by the Summit Shareholders by ordinary resolution pursuant to the provisions summarized under

The office of any director shall be vacated if:

(a) such director resigns their office by notice in writing to YS Biopharma;

(b) such director becomes bankrupt or makes any arrangement or composition with such director's creditors;

(c) such director dies or is found to be or becomes of unsound mind;

(d) such director is removed from office by notice addressed to such director at their last known address and signed by all of the co-directors (not being less than two in number); or

(e) such director is removed from office pursuant to the provisions of the Amended YS Biopharma Articles.

“Election/Removal of Directors” above.

#### **Amendment to Articles of Association**

Pursuant to the Cayman Islands Companies Act, the Summit Articles may only be amended by shareholders by a special resolution (as defined in the Summit Articles); provided that, prior to the closing of the initial business combination, in the event that any amendment is made to the Summit Articles (a) to modify the substance or timing of Summit’s obligation to allow redemption in connection with a business combination or redeem 100 per cent of the Summit Public Shares if Summit does not consummate a business combination within 24 months from the consummation of the Summit IPO or such later time approved in accordance with the Summit Articles or (b) with respect to any other provision of the Summit Articles relating to the rights of holders of Summit Public Shares or pre-Business Combination activity, each Summit Public Shareholder (who is not the Sponsor, a Founder, Officer or Director) shall be provided with the opportunity to redeem their Summit Public Shares upon the approval or effectiveness of any such amendment at a per-share price, payable in cash, equal to the aggregate amount then on deposit in the Trust Account, including interest earned in the Trust Account and not previously released to Summit to pay its income taxes, divided by the number of Summit Public Shares then outstanding, provided that Summit shall not redeem Summit Public Shares in an amount that would cause Summit’s net tangible assets to be less than \$5,000,001 following such redemption.

YS Biopharma may at any time and from time to time by special resolution (as defined by the Cayman Islands Companies Act) alter or amend the Amended YS Biopharma Articles, in whole or in part.

#### **Quorum**

*Shareholders.* No business shall be transacted at any general meeting unless a quorum of shareholders is present. One or more shareholders holding in the aggregate not less than one-third of the total issued Summit Shares present in person or by duly authorised representative or proxy and entitled to vote shall be a quorum for a general meeting of Summit.

*Board of Directors.* The quorum for the transaction of the business of the Summit Board may be fixed by the Summit directors, and unless so fixed shall be a majority of the Summit directors then in office.

*Shareholders.* No business will be transacted at any general meeting unless a quorum of shareholders is present at the time when the meeting proceeds to business. One or more shareholders holding not less than one-third of all votes attaching to the total issued shares of YS Biopharma in issue present in person or by proxy and entitled to vote will be a quorum for all purposes.

*Board of Directors.* The quorum necessary for the transaction of the business of the YS Biopharma board of directors may be fixed by the directors and unless so fixed will be a majority of the directors then in office.



**Summit****YS Biopharma****Shareholder Meetings**

Summit may, but will not (unless required by the Cayman Islands Companies Act) be obliged to hold an annual general meeting.

All general meetings other than annual general meetings shall be called extraordinary general meetings.

General meetings may be called by the Summit directors, the chief executive officer or the chairman of the Summit Board and will be held at such time and place as the Summit directors shall appoint. Shareholders shall not have the ability to call general meetings.

YS Biopharma is not obliged by the Cayman Islands Companies Act to call shareholders' annual general meetings. The Amended YS Biopharma Articles provide that YS Biopharma may (but are not obliged to) in each year hold a general meeting as its annual general meeting in which case YS Biopharma shall specify the meeting as such in the notices calling it, and the annual general meeting shall be held at such time and place as may be determined by the directors of YS Biopharma.

The directors may call extraordinary general meetings whenever they think fit, and must convene an extraordinary general meeting upon the requisition of YS Biopharma shareholders holding at least one third of the votes that may be cast at such meeting or called by: (a) the chairperson of the board of directors (the "Chairperson"); or (b) a majority of the entire board of directors.

**Notice of Shareholder Meetings**

At least five clear days' notice shall be given of any general meeting. Clear days means that period excluding the day when the notice is received or deemed to be received and the day for which it is given or on which it is to take effect. Every notice shall specify the place, the day and the hour of the meeting and the general nature of the business to be conducted at the general meeting and will be given in the manner hereinafter mentioned or in such other manner if any as may be prescribed by Summit Shareholders by ordinary resolution to such persons as are, under the Summit Articles, entitled to receive such notices; provided that a general meeting of Summit will, whether or not the notice provisions have been complied with, be deemed to have been duly convened if it is so agreed:

(a) in the case of an annual general meeting, by all shareholders entitled to attend and vote thereat; and

(b) in the case of an extraordinary general meeting, by a majority in number of the shareholders having a right to attend and vote at the meeting, together holding not less than ninety-five per cent in par value of the Summit Shares giving that right.

At least seven calendar days' notice will be given for any general meeting. Every notice will be exclusive of the day on which it is given or deemed to be given and will specify the place, the day and the hour of the meeting and the general nature of the business to be conducted at the meeting and will be given in the manner hereinafter mentioned or in such other manner as may be prescribed by YS Biopharma shareholders by ordinary resolution; provided that a general meeting of YS Biopharma will, whether or not the notice provisions have been complied with, be deemed to have been duly convened if it is so agreed by two-thirds of the shareholders (or their proxies) having a right to attend and vote at the meeting.

**Indemnification, liability insurance of Directors and Officers**

Every director and officer of Summit (which for the avoidance of doubt, shall not include auditors of Summit), together with every former director and former officer of Summit (each an "Indemnified Person") shall be indemnified out of Summit's assets against any liability, action, proceeding, claim,

To the maximum extent permitted by applicable law, every director and officer of YS Biopharma, will be indemnified and secured harmless against all actions, proceedings, costs, charges, expenses, losses, damages or liabilities incurred or sustained by such person, other than by reason of such person's own dishonesty,

**Summit**

demand, costs, damages or expenses, including legal expenses, whatsoever which they or any of them may incur as a result of any act or failure to act in carrying out their functions other than such liability (if any) that they may incur by reason of their own actual fraud, willful neglect or willful default. No person shall be found to have committed actual fraud, willful default or willful neglect unless or until a court of competent jurisdiction shall have made a finding to that effect.

Summit shall advance to each Indemnified Person reasonable attorneys' fees and other costs and expenses incurred in connection with the defense of any action, suit, proceeding or investigation involving such Indemnified Person for which indemnity will or could be sought under the Summit Articles.

The directors, on behalf of Summit, may purchase and maintain insurance for the benefit of any Summit director or officer against any liability which, by virtue of any rule of law, would otherwise attach to such person in respect of any negligence, default, breach of duty or breach of trust of which such person may be guilty in relation to Summit.

**Dividends**

Subject to the Cayman Islands Companies Act and the Summit Articles and except as otherwise provided by the rights attached to any Summit Shares, the Summit directors may resolve to pay dividends and other distributions on Summit Shares in issue and authorize payment of the dividends or other distributions out of the funds of Summit lawfully available therefor. A dividend will be deemed to be an interim dividend unless the terms of the resolution pursuant to which the Summit directors resolve to pay such dividend specifically state that such dividend will be a final dividend. No dividend or other distribution will be paid except out of the realized or unrealized profits of Summit, out of the share premium account or as otherwise permitted by law.

**Winding up**

The Summit Articles provide that if Summit does not consummate a business combination (as defined in the Summit Articles) within twenty-four months after the consummation of Summit's IPO, Summit will cease all operations except for the purposes of winding up, as promptly as reasonably possible but not more than ten business days thereafter, redeem the Summit Public Shares at a per-Share price, payable in cash, equal to the aggregate amount then

**YS Biopharma**

wilful default or fraud, in or about the conduct of YS Biopharma's business or affairs (including as a result of any mistake of judgment) or in the execution or discharge of his duties, powers, authorities, discretions, including without prejudice to the generality of the foregoing, any costs, expenses, losses or liabilities incurred by such person in defending (whether successfully or otherwise) any civil proceedings concerning YS Biopharma or its affairs in any court whether in Cayman Islands or elsewhere.

Subject to the Cayman Islands Companies Act, rights and restrictions attached to any class of shares and the Amended YS Biopharma Articles, the directors may from time to time declare dividends and other distributions on YS Biopharma Ordinary Shares in issue and authorize payment of the same out of the funds of YS Biopharma lawfully available therefor.

Subject to rights and restrictions attached to any class of shares and the Amended YS Biopharma Articles, YS Biopharma shareholders may by ordinary resolution declare dividends, but no dividend may exceed the amount recommended by the directors.

The directors when paying dividends to the shareholders in accordance with the foregoing provisions may make such payment either in cash or in specie.

Subject to the rights attaching to any shares, in a winding up:

(a) if the assets available for distribution amongst the shareholders are insufficient to repay the whole of YS Biopharma's issued share capital, such assets will be distributed so that, as nearly as may be, the losses be borne by the shareholders in proportion to the par value of the shares held by them; or

**Summit**

on deposit in the Trust Account, including interest earned on the funds held in the Trust Account and not previously released to Summit (less taxes payable and up to \$100,000 of interest to pay dissolution expenses), divided by the number of then Public Shares in issue, which redemption will completely extinguish public Shareholders' rights as shareholders (including the right to receive further liquidation distributions, if any); and as promptly as reasonably possible following such redemption, subject to the approval of Summit's remaining Shareholders and the directors, liquidate and dissolve.

Subject to the rights attaching to any shares, in a winding up:

(a) if the assets available for distribution amongst the shareholders are insufficient to repay the whole of Summit's issued share capital, such assets shall be distributed so that, as nearly as may be, the losses shall be borne by the shareholders in proportion to the par value of the shares held by them; or

(b) if the assets available for distribution amongst the shareholders are more than sufficient to repay the whole of Summit's issued share capital at the commencement of the winding up, the surplus shall be distributed amongst the shareholders in proportion to the par value of the shares held by them at the commencement of the winding up subject to a deduction from those shares in respect of which there are monies due, of all monies payable to Summit for unpaid calls or otherwise.

If Summit is wound up, the liquidator may, subject to the rights attaching to any shares and with the approval of a special resolution and any other approval required by the Cayman Islands Companies Act, divide amongst the shareholders in kind the whole or any part of the assets of Summit (whether such assets consist of property of the same kind or not) and may for that purpose value any assets and determine how the division shall be carried out as between the shareholders or different classes of shareholders. The liquidator may, with the like approval, vest the whole or any part of such assets in trustees upon such trusts for the benefit of the shareholders as the liquidator, with the like approval, shall think fit, but so that no shareholder shall be compelled to accept any asset upon which there is a liability.

**Supermajority Voting Provisions**

A special resolution, requiring not less than a two-thirds vote (and, prior to the closing of a business combination, with respect to an amendment to the

**YS Biopharma**

(b) if the assets available for distribution amongst the shareholders are more than sufficient to repay the whole of YS Biopharma's issued share capital at the commencement of the winding up, the surplus will be distributed amongst the shareholders in proportion to the par value of the shares held by them at the commencement of the winding up subject to a deduction from those shares in respect of which there are monies due, of all monies payable to YS Biopharma for unpaid calls or otherwise.

If YS Biopharma is wound up, the liquidator may, subject to the rights attaching to any shares and with the approval of a special resolution, divide amongst the shareholders in kind the whole or any part of the assets of YS Biopharma, and whether or not the assets consist of property of a single kind, and may for that purpose set such value as the liquidator deems fair upon any one or more class or classes of property, and determine how the division will be carried out as between the shareholders. The liquidator may, with the like approval, vest any part of such assets in trustees upon such trusts for the benefit of the shareholders as the liquidator, with the like approval, shall think fit, but so that no shareholder shall be compelled to accept any asset upon which there is a liability.

A special resolution, requiring not less than a two-thirds of the votes cast by shareholders of YS Biopharma, is required to:

Summit	YS Biopharma
<p>provisions in Summit's Articles governing the appointment or removal of directors prior to an initial business combination, also requiring the approval of a simple majority of the Founder Shares), is required to:</p> <p>(a) alter or add to the Summit Articles;</p> <p>(b) change Summit's name;</p> <p>(c) alter or add to the Summit Memorandum with respect to any objects, powers or other matters specified therein;</p> <p>(d) change Summit's registration to a jurisdiction outside the Cayman Islands;</p> <p>(e) merge or consolidate Summit with one or more other constituent companies;</p> <p>(f) reduce Summit's share capital or any capital redemption reserve fund; and</p> <p>(g) in a winding up, approve the liquidator to divide amongst the shareholders the assets of Summit, value the assets for that purpose and determine how the division will be carried out between the shareholders or different classes of shareholders, or vest the whole or any part of such assets in trustees upon such trusts for the benefit of the shareholders as the liquidator shall think fit, except that no shareholder shall be compelled to accept any asset upon which there is a liability.</p> <p>Additionally, prior to the closing of the initial business combination, only holders of Founder Shares will have the right to vote on a shareholder resolution for the appointment or removal of directors.</p>	<p>(a) amend the Amended YS Biopharma Articles;</p> <p>(b) change YS Biopharma's name;</p> <p>(c) change YS Biopharma's registration to a jurisdiction outside the Cayman Islands;</p> <p>(d) merge or consolidate YS Biopharma with one or more other constituent companies;</p> <p>(e) reduce YS Biopharma's share capital and any capital redemption reserve; and</p> <p>(f) in a winding up, direct the liquidator to divide amongst the shareholders the assets of YS Biopharma, value the assets for that purpose and determine how the division will be carried out between the shareholders or different classes of shareholders.</p>

#### Anti-Takeover Provisions

The provision of the Summit Articles that authorizes the Summit Board to issue and set the voting and other rights of preference shares from time to time and the terms and rights of the Summit Shares.

The provision of the Amended YS Biopharma Articles that authorizes the board of directors to issue and set the voting and other rights of preference shares from time to time.

## BENEFICIAL OWNERSHIP OF SECURITIES

The following table sets forth information regarding the expected beneficial ownership of YS Biopharma Ordinary Shares immediately following the consummation of the Business Combination by:

- each person who is expected to beneficially own 5.0% or more of the outstanding YS Biopharma Ordinary Shares;
- each person who will become an executive officer or director of YS Biopharma; and
- all of those executive officers and directors of YS Biopharma as a group.

Beneficial ownership is determined in accordance with the rules of the SEC and includes voting or investment power with respect to, or the power to receive the economic benefit of ownership of, the securities. In computing the number of shares beneficially owned by a person and the percentage ownership of that person, shares that the person has the right to acquire within 60 days are included, including through the exercise of any option or other right or the conversion of any other security. However, these shares are not included in the computation of the percentage ownership of any other person.

The expected beneficial ownership percentages set forth in the table below have been determined based on the followings: (i) assuming the consummation of the YS Biopharma Capital Restructuring, (ii) assuming a No Redemption Scenario and that no Summit shareholder and no YS Biopharma shareholder exercises its dissenters' rights, the total number of YS Biopharma Ordinary Shares expected to be outstanding after the Closing of the Business Combination will be 113,460,795, and (iii) assuming a 100% Redemption Scenario, the total number of YS Biopharma Ordinary Shares expected to be outstanding after the Closing of the Business Combination will be 92,174,995. If the actual facts differ from these assumptions, these amounts will differ.

	Ordinary Shares of YS Biopharma Beneficially Owned Immediately Prior to Closing of the Business Combination		Ordinary Shares of YS Biopharma Beneficially Owned Immediately Upon the Closing of the Business Combination					
	Number	%	No Redemption Scenario			100% Redemption Scenario		
			Number of ordinary shares	% of total ordinary shares	% of voting power <sup>†</sup>	Number of ordinary shares	% of total ordinary shares	% of voting power <sup>†</sup>
<b>Directors and Executive Officers<sup>(1)</sup>:</b>								
Mr. Yi Zhang <sup>(1)</sup>	48,615,000	58.27	48,615,000	42.85	42.85	48,615,000	52.74	52.74
Dr. Hui Shao <sup>(3)</sup>	2,002,780	2.40	2,002,780	1.77	1.77	2,002,780	2.17	2.17
Mr. Bo Tan <sup>(4)</sup>	—	—	3,853,475	3.40	3.40	3,853,475	4.18	4.18
Dr. Ajit Shetty	*	*	*	*	*	*	*	*
Dr. Viren Mehta	*	*	*	*	*	*	*	*
Dr. Stanley Yi Chang	*	*	*	*	*	*	*	*
Mr. Shaojing Tong	—	—	—	—	—	—	—	—
Dr. Zenaida Reynoso Mojares	—	—	—	—	—	—	—	—
Ms. Chunyuan Wu	*	*	*	*	*	*	*	*
Dr. Yuan Liu	—	—	—	—	—	—	—	—
Mr. Gang Li	—	—	—	—	—	—	—	—
All Directors and Executive Officers as a Group	51,004,891	61.14	54,858,366	48.35	48.35	54,858,366	59.52	59.52
<b>Principal Shareholders:</b>								
Mr. Yi Zhang and his affiliated entities <sup>(1)</sup>	48,615,000	58.27	48,615,000	42.85	42.85	48,615,000	52.74	52.74
OrbiMed Entities <sup>(5)</sup>	4,298,465	5.15	4,298,465	3.79	3.79	4,298,465	4.66	4.66

---

\* Less than 1%.

† For each person or group included in this column, percentage of total voting power represents voting power based on all outstanding issued YS Biopharma Ordinary Shares.

- (1) The business address of YS Biopharma’s directors and executive officers is Building No. 2, 38 Yongda Road, Daxing Biomedical Industry Park, Daxing District, Beijing, PRC.
- (2) Represents (1) 38,972,000 ordinary shares held by All Brilliance Investments Limited, a limited liability company incorporated under the laws of British Virgin Islands and being wholly-controlled by Mr. Zhang; (2) 4,571,500 ordinary shares held by Hopeful World Company Limited, a limited liability company incorporated under the laws of British Virgin Islands and being wholly-controlled by Ms. Rui Mi, the spouse of Mr. Yi Zhang; (3) 2,435,750 ordinary shares held by Acton Town International Limited, a limited liability company incorporated under the laws of British Virgin Islands and being held wholly-controlled by Ms. Nan Zhang, a daughter of Mr. Yi Zhang; (4) 2,435,750 ordinary shares held by Apex Pride Global Limited, a limited liability company incorporated under the laws of British Virgin Islands and being held wholly-controlled by Ms. Xu Zhang, a daughter of Mr. Yi Zhang; and (5) 200,000 ordinary shares directly held by Mr. Yi Zhang. Mr. Yi Zhang and his aforementioned affiliates have entered into an acting-in-concert agreement to act in concert with Mr. Yi Zhang. See the section entitled “Certain Relationships and Related Person Transactions — YS Group and YS Biopharma Relationships and Related Party Transactions — Concert Party Agreement” and “Summary of the Proxy Statement/Prospectus — The Parties to the Business Combination” for details. The registered address of All Brilliance Investments Limited is Wickhams Cay II, Road Town, Tortola, VG1110, British Virgin Islands. All the registered addresses of Hopeful World Company Limited, Acton Town International and Apex Pride Global Limited are Portcullis TrustNet Chambers, P.O. Box 3444, Road Town, Tortola, British Virgin Islands.
- (3) Represents (1) 1,802,780 ordinary shares held by Mountainview Investment Holdings LLC, a limited liability company incorporated under the laws of British Virgin Islands and being wholly-controlled by Mr. Hui Shao; and (2) 200,000 ordinary shares directly held by Mr. Hui Shao. The registered address of Mountainview Investment Holdings LLC is Wickhams Cay II, Road Town, Tortola, VG1110, British Virgin Islands.
- (4) The shares reported are held in the name of the Sponsor. Mr. Bo Tan is one of the three managers of the Sponsor. The managers have voting and investment discretion with respect to the ordinary shares held of record by the Sponsor. Each of the managers of the Sponsor disclaims any beneficial ownership of the securities held by the Sponsor other than to the extent of any pecuniary interest they may have therein, directly or indirectly.
- (5) Represents (1) 889,300 ordinary shares held by OrbiMed New Horizons Master Fund, L.P. (“ONH”), an exempted limited partnership under the laws of the Cayman Islands; (2) 701,352 shares held by OrbiMed Genesis Master Fund, L.P. (“Genesis”), an exempted limited partnership under the laws of the Cayman Islands; (3) 2,104,054 ordinary shares held by The Biotech Growth Trust PLC (“BIOG”), a publicly listed trust organized under the laws of England; (4) 530,688 ordinary shares held by OrbiMed Partners Master Fund Limited (“OPM”), an exempted company under the laws of Bermuda; and (5) 73,071 ordinary shares held by OrbiMed Partners SPV, Ltd. (“OrbiMed SPV”), an exempted company under the laws of the Cayman Islands, (collectively, the “OrbiMed Entities”). OrbiMed Capital LLC is the investment advisor of OPM and the portfolio manager of BIOG. OrbiMed Advisors LLC is the investment manager for ONH, Genesis, and OrbiMed SPV. OrbiMed Capital LLC and OrbiMed Advisors LLC exercise voting and investment power through a management committee comprised of Carl L. Gordon, Sven H. Borho, and W. Carter Neild, all of whom are independent third parties. The business address of the OrbiMed Entities is c/o OrbiMed Advisors LLC, 601 Lexington Avenue, 54th Floor, New York, NY 10022.

## CERTAIN RELATIONSHIPS AND RELATED PERSON TRANSACTIONS

### Summit Relationships and Related Party Transactions

#### *Founder Shares*

On December 31, 2020, Summit issued to the Sponsor 5,750,000 Summit Class B Ordinary Shares, (i.e. Founder Shares) for \$25,000 for certain expenses paid on behalf of Summit, or approximately \$0.004 per share. On April 30, 2021, Summit effected a share capitalization, pursuant to which Summit's initial shareholders held an aggregate of 6,500,000 Summit Class B Ordinary Shares. The accompanying unaudited condensed financial statements have been retroactively adjusted to reflect the stock dividend in the share capitalization. On April 30, 2021, Summit entered into Forward Purchase Agreements with Forward Purchase Investors, in connection with entering into the Forward Purchase Agreements, the Sponsor transferred to the Forward Purchase Investors an aggregate of 375,000 Summit Class B Ordinary Shares for no cash. On April 30, 2021, the Sponsor transferred 25,000 Summit Class B Ordinary Shares to each of the three independent director nominees. Up to 750,000 Summit Class B Ordinary Shares were subject to forfeiture by the Sponsor depending on the extent to which the underwriters' over-allotment option is exercised. On July 23, 2021, the Sponsor surrendered 750,000 Summit Class B Ordinary Shares, with no return of capital or payment by the Sponsor, after the expiration of the unexercised underwriters' over-allotment option. As a result of the foregoing, on September 30, 2022 and December 31, 2021, respectively, the Sponsor owned 5,750,000 Summit Class B Ordinary Shares.

The Sponsor, officers and directors have agreed not to transfer, assign or sell any of their Summit Class B Ordinary Shares until earliest of (A) one year after the completion of the initial business combination and (B) subsequent to the initial business combination, (x) if the closing price of Summit Class A Ordinary Shares equals or exceeds \$12.00 per share (as adjusted for share subdivisions, share capitalizations, reorganizations, recapitalizations and the like) for any 20 trading days within any 30-trading day period commencing at least 150 days after the initial business combination, or (y) the date on which Summit completes a liquidation, merger, share exchange or other similar transaction that results in all of Summit Public Shareholders having the right to exchange their ordinary shares for cash, securities or other property (the "Lock-up"). Any permitted transferees would be subject to the same restrictions and other agreements of the Sponsor, officers and directors with respect to any Summit Class B Ordinary Shares.

#### *Promissory Note*

The Sponsor has agreed to loan Summit up to \$300,000 to be used for a portion of the expenses of the IPO. These loans were non-interest bearing, unsecured and were due at the earlier of September 30, 2021 or the closing of the IPO. The loan was to be repaid upon completion of the IPO out of the \$1,000,000 of offering proceeds that has been allocated to the payment of offering expenses. Summit had drawn down \$140,068 under the promissory note which was repaid as of June 11, 2021. The note was terminated on June 11, 2021.

#### *Related Party Loans*

In addition, in order to finance transaction costs in connection with an intended initial business combination, the Sponsor or an affiliate of the Sponsor, or certain of Summit's officers and directors may, but are not obligated to, loan Summit funds as may be required ("Working Capital Loans"). If Summit completes the initial business combination, Summit may repay the Working Capital Loans out of the proceeds of the Trust Account released to Summit. In the event that the initial business combination does not close, Summit may use a portion of the working capital held outside the Trust Account to repay the Working Capital Loans but no proceeds from the Trust Account would be used to repay the Working Capital Loans. Up to \$1,500,000 of such Working Capital Loans may be convertible into warrants at a price of \$1.00 per warrant at the option of the lender. Such warrants would be identical to the Summit Private Warrants.

On September 29, 2022, Summit issued an unsecured, interest-free promissory note to the Sponsor pursuant to which Summit may borrow up to \$1,500,000 from the Sponsor for costs and expenses reasonably related to Summit's working capital needs prior to the consummation of the Business Combination ("Convertible Promissory Note"). All unpaid principal under the Convertible Promissory Note will become due and payable in full on the date on which Summit consummates the Business Combination, unless earlier accelerated upon

the occurrence of an event of default. The Sponsor will have the option, at any time on or prior to the maturity date, to convert any amounts outstanding under the Convertible Promissory Note, up to \$1,500,000 in the aggregate, into warrants to purchase Summit Class A Ordinary Shares, at a conversion price of \$1.00 per warrant, with each warrant entitling the holder to purchase one Summit Class A Ordinary Share at a price of \$11.50 per share, subject to the same adjustments applicable to the private placement warrants sold concurrently with the IPO. As of September 30, 2022, there were no outstanding amount under the Convertible Promissory Note. On October 12, 2022, Summit had drawn down \$700,000 under the Convertible Promissory Note. The Convertible Promissory Note will be valued using the fair value method at each reporting period.

## **YS Group and YS Biopharma Relationships and Related Party Transactions**

### ***Shareholders Support Agreement***

See the section entitled “Shares Eligible for Future Sale.”

### ***Employment Agreements and Indemnification Agreements***

See the section entitled “Management-Employment Agreements and Indemnification Agreements.”

### ***Share Incentive Plans***

See the section entitled “Management-Share Incentive Plans.”

### ***Other Related Party Transactions***

	For the Years Ended March 31,		
	2021	2022	2022
	(RMB)	(RMB)	(\$)
<b>Amounts due from related party:</b>			
<b>Yisheng Biopharma Holdings Limited (Hong Kong)</b>			
Receivable collected on behalf of YS Group	30,088,833	2,966,777	\$ 459,412
Repayment to YS Group		33,055,610	\$5,118,732

In fiscal 2021, YS Biopharma lent RMB30,088,833 to Yisheng Biopharma Holdings Limited (Hong Kong) for its operating needs. In fiscal 2022, YS Group lent another RMB2,966,777 to Yisheng Biopharma Holdings Limited (Hong Kong), and Yisheng Biopharma Holdings Limited (Hong Kong) repaid RMB33,055,610 in full to YS Group. As of March 31, 2022, the balance of amount due from Yisheng Biopharma Holdings Limited (Hong Kong) is RMB nil.

From time to time, and prior to the business reorganization that completed in February 2021, YS Biopharma borrowed or lent money to or from the following related parties that were under common control of Mr. Zhang for working capital purposes:

#### *Henan Yisheng Biopharma Co., Ltd. (“Henan Yisheng Biopharma”)*

As of March 31, 2020, YS Group owed Henan Yisheng Biopharma was RMB102,868,404. In fiscal year 2021, Henan Yisheng Biopharma lent RMB 213,545,060 to YS Group for its operating needs, and YS Group repaid RMB147,375,441 to Henan Yisheng Biopharma. Henan Yisheng Biopharma forgave the remaining debts, RMB169,038,024 during the fiscal year ended March 31, 2021.

#### *Beijing Yisheng Xingye Technology Co., Ltd. (PRC) (“Beijing Yisheng Xingye”)*

As of March 31, 2020, YS Group owned Beijing Yisheng Xingye Technology Co., Ltd. (PRC) RMB204,218,333. In fiscal year 2021, Beijing Yisheng Xingye lent RMB155,014,765 to YS Group for its operating needs, and YS Group repaid RMB47,360,000 to Beijing Yisheng Xingye. Beijing Yisheng Xingye forgave the remaining debts, RMB311,873,098. As of March 31, 2021, the balance of amount due to Beijing



Yisheng Xingye was RMB nil. In fiscal year 2022, Beijing Yisheng Xingye lent RMB46,970 to YS Group, and YS Group repaid it in full. As of March 31, 2022, the balance of amount due to Beijing Yisheng Xingye was RMB nil.

*Henan Yisheng Pan-Asia Co., Ltd. (“Henan Yisheng Pan-Asia”)*

As of March 31, 2020, YS Group owed Henan Yisheng Pan-Asia Co., Ltd. RMB8,000. In fiscal 2021, YS Group repaid RMB8,000 in full to Henan Yisheng Pan-Asia.

*Other Related Parties*

As of March 31, 2020, YS Group owed RMB7,792,152 in total to the following individual: Xu Zhang, Hui Shao, Zhongkai Shi, Yi Zhang and Nan Zhang. In fiscal year 2021, these individuals lent RMB445,833 in total to YS Group, and YS Group repaid RMB8,237,985 in full to these individuals.

*Liaoning Yisheng Pan-Asia Co., Ltd. (“Liaoning Yisheng Pan-Asia”)*

As of March 31, 2020, the Liaoning Yisheng Pan-Asia owed YS Group RMB30,780,298. In fiscal 2021, YS Group lent RMB8,423,885 to Liaoning Yisheng Pan-Asia, and Liaoning Yisheng Pan-Asia repaid RMB6,700,388 to YS Group. YS Group forgave the remaining RMB32,503,795. As of March 31, 2021, the amount due from Liaoning Yisheng Pan-Asia was RMB nil.

*Henan Yisheng Huizhong Co., Ltd. (“Henan Yisheng Huizhong”)*

As of March 31, 2020, Henan Yisheng Huizhong owed YS Group RMB1,744,800. In fiscal 2021, YS Group lent RMB570,000 to Henan Yisheng Huizhong. YS Group forgave Henan Yisheng Huizhong’s debts of RMB2,314,800. As of March 31, 2021, the amount due from Henan Yisheng Huizhong was RMB nil.

*Yisheng Biopharma Co., Ltd. (“Yisheng Biopharma”)*

In fiscal 2022, Yisheng Biopharma lent RMB64,880 to YS Group, and YS Group repaid it in full during the same year. As of March 31, 2022, the amount due to Yisheng Biopharma was RMB nil.

*Concert Party Agreement*

Yi Zhang and the entities controlled by Yi Zhang, including (i) An Diang Group Holdings Limited, YXRT Company Limited and All Brilliance Investments Limited; (ii) Rui Mi and the entities controlled by Rui Mi, including Honeydrew Flower Field Ltd., ZM Home Limited and Hopeful World Company Limited; (iii) Xu Zhang and the entities controlled by Xu Zhang, including Apex Pride Global Limited, Prosperous Sunrise Company Limited and Much Galaxy Company Limited; and (iv) Nan Zhang and the entities controlled by Nan Zhang, including Spring Nanmu Islands Ltd., NNZF Company Limited and Acton Town International Limited (the “Concert Parties”) entered into a concert party agreement dated as of March 3, 2021 (the “Concert Party Agreement”), pursuant to which, the Concert Parties agree and acknowledge that they have voted since commencement of YS Group’s business, and will continue to vote, themselves or through any entity directly or indirectly controlled by them that own YS Biopharma’s equity interest, unanimously for any resolutions proposed at the board meetings and/or shareholders meeting of YS Biopharma, where applicable. According to the Concert Party Agreement, if the Concert Parties are unable to reach unanimous consensus, Yi Zhang is entitled to determine how to vote for and on behalf of himself and the Concert Parties. The Concert Agreement will continue after the Business Combination and shall remain effective unless otherwise terminated by mutual consent of the Concert Parties.

## SHARES ELIGIBLE FOR FUTURE SALE

Upon the consummation of the Business Combination, YS Biopharma will have, up to 113,470,795 YS Biopharma Ordinary Shares issued and outstanding, assuming no redemption, or up to 92,184,995 YS Biopharma Ordinary Shares issued and outstanding, assuming 100% redemption (each of which includes 10,000 YS Biopharma Ordinary Shares to be issued as part of advisory fees to YS Biopharma's financial advisor). All of the YS Biopharma Ordinary Shares issued to the Summit Shareholders in connection with the Business Combination will be freely transferable by persons other than by the Sponsor and YS Biopharma's affiliates without restriction or further registration under the Securities Act. Sales of substantial amounts of the YS Biopharma Ordinary Shares in the public market could adversely affect prevailing market prices of the YS Biopharma Ordinary Shares. Prior to the Business Combination, there has been no public market for YS Biopharma Ordinary Shares. YS Biopharma has applied for listing, to be effective at the time of the Initial Closing, of the YS Biopharma Ordinary Shares and the YS Biopharma Warrants on Nasdaq, but there can be no assurance that a regular trading market will develop in the YS Biopharma Ordinary Shares and the YS Biopharma Warrants.

### Lock-up Arrangements

Concurrently with the execution of the Business Combination Agreement, Summit and YS Biopharma agree, pursuant to the Shareholder Support Agreement, to cause the Sponsor and the independent directors of Summit (together with the Sponsor, the "SPAC Insiders") and all pre-Closing shareholders of YS Biopharma (together with the SPAC Insiders, the "YS Biopharma Lock-Up Shareholders") to be subject to certain lock-up restrictions as provided therein, effective as of the First Merger Effective Time, pursuant to which, any YS Biopharma Ordinary Shares held by such YS Biopharma Lock-Up Shareholder immediately after the First Merger Effective Time (such YS Biopharma Ordinary Shares, collectively, the "YS Biopharma Lock-Up Shares") shall not be transferred during the applicable lock-up period, subject to customary exceptions. For each YS Biopharma Lock-Up Shareholder who is not a SPAC Insider, the applicable lock-up period will be 180 days from and after the First Merger Effective Time. For each YS Biopharma Lock-Up Shareholder who is a SPAC Insider, the applicable lock-up period will be twelve months from and after the First Merger Effective Time. The lock-up requirements will cease to apply after the date on which the closing price of the YS Biopharma Ordinary Shares equals or exceeds \$12.00 per share for any 20 trading days within any 30 trading day period commencing at least 150 days after the First Merger Effective Time. YS Biopharma may release, (i) in its sole discretion, up to 3,000,000 YS Biopharma Lock-Up Shares and (ii) with prior written consent from Summit and the Sponsor, an additional number of YS Biopharma Lock-Up Shares to the extent necessary to satisfy the minimum public float requirement as required for obtaining Nasdaq's listing approval, provided that a release pursuant to sub-clauses (i) and (ii) shall apply on a pro rata basis to all YS Biopharma Lock-Up Shares held by YS Biopharma Lock-Up Shareholders who are holders of preferred shares of YS Biopharma (and ordinary shares issued upon conversion thereof) immediately prior to the First Merger Effective Time.

### Registration Rights

Concurrently with the execution of the Business Combination Agreement, pursuant to the Shareholder Support Agreement, the Supporting Shareholders, together with any other shareholder of YS Biopharma who currently is or subsequently becomes a party to the YS Biopharma Shareholders Agreement, are entitled to customary demand and piggyback registration rights. YS Biopharma also agrees to file a registration statement on Form F-1 within 20 days after the Closing (or 60 days if additional financial information is required) to register the registrable securities pursuant to the YS Biopharma Shareholders Agreement.

### Rule 144

Rule 144 is not available for the resale of securities initially issued by shell companies (other than business combination related shell companies) or issuers that have been at any time previously a shell company. However, Rule 144 also includes an important exception to this prohibition if the following conditions are met:

- the issuer of the securities that was formerly a shell company has ceased to be a shell company;

- the issuer of the securities is subject to the reporting requirements of Section 13 or 15(d) of the Exchange Act;
- the issuer of the securities has filed all Exchange Act reports and material required to be filed, as applicable, during the preceding 12 months (or such shorter period that the issuer was required to file such reports and materials); and
- at least one year has elapsed from the time that the issuer filed Form 20-F type information with the SEC, which is expected to be filed promptly after consummation of the Business Combination, reflecting its status as an entity that is not a shell company.

Pursuant to Rule 144 under the Securities Act (“Rule 144”), a person who has beneficially owned restricted YS Biopharma Ordinary Shares or YS Biopharma Warrants for at least six months would be entitled to sell their securities; provided that (i) such person is not deemed to have been one of YS Biopharma’s affiliates at the time of, or at any time during the three months preceding, a sale and (ii) YS Biopharma is subject to the Exchange Act periodic reporting requirements for at least three months before the sale and have filed all required reports under Section 13 or 15(d) of the Exchange Act during the 12 months (or such shorter period as it was required to file reports) preceding the sale.

Persons who have beneficially owned restricted YS Biopharma Ordinary Shares or YS Biopharma Warrants for at least six months but who are YS Biopharma’s affiliates at the time of, or at any time during the three months preceding, a sale, would be subject to additional restrictions, by which such person would be entitled to sell within any three-month period only a number of securities that does not exceed the greater of:

- one percent (1%) of the total number of YS Biopharma Ordinary Shares then issued and outstanding; or
- the average weekly reported trading volume of the YS Biopharma Ordinary Shares during the four calendar weeks preceding the filing of a notice on Form 144 with respect to the sale.

Sales by YS Biopharma’s affiliates under Rule 144 are also limited by manner of sale provisions and notice requirements and to the availability of current public information about YS Biopharma.

#### **Form S-8**

YS Biopharma intends to file a registration statement on Form S-8 under the Securities Act covering all YS Biopharma Ordinary Shares which are either subject to outstanding options or may be issued upon exercise of any options or other equity awards which may be granted or issued in the future pursuant to the YS Biopharma 2022 Plan. YS Biopharma expects to file this registration statement as soon as practicable after the date of this prospectus. Shares registered under any registration statements will be available for sale in the open market, except to the extent that the shares are subject to vesting restrictions with YS Biopharma or the contractual restrictions described elsewhere in this proxy statement/prospectus.

## PRICE RANGE OF SECURITIES AND DIVIDEND INFORMATION

Summit's Units, the Summit Public Shares and the Summit Public Warrants are each traded on Nasdaq the symbols "SMIHU," "SMIH" and "SMIHW," respectively.

The closing price of the Units, Summit Public Shares and Summit Public Warrants on September 28, 2022, the last trading day before announcement of the execution of the Business Combination Agreement, was \$9.85, \$9.82 and \$0.0953, respectively. As of February 2, 2023, the "Record Date" for the Extraordinary General Meeting, the most recent closing price for each Unit, Summit Public Share and Summit Public Warrant was \$10.09, \$10.12 and \$0.2774, respectively.

Holders of the Units, Summit Public Shares and Summit Public Warrants should obtain current market quotations for their securities. The market price of Summit's securities could vary at any time before the Business Combination.

Historical market price information regarding YS Biopharma is not provided because there is no public market for their securities.

YS Biopharma, which will be the public company after the consummation of the Business Combination, has applied to list the YS Biopharma Ordinary Shares and YS Biopharma on Nasdaq under the symbols "YS" and "YSBPW", respectively. It is a condition to consummation of the Business Combination in the Business Combination Agreement that the YS Biopharma Ordinary Shares and YS Biopharma Warrants to be issued in connection with the Business Combination shall have been approved for listing on Nasdaq, subject only to official notice of issuance thereof. YS Biopharma and Summit have certain obligations in the Business Combination Agreement to use reasonable best efforts in connection with the Business Combination, including with respect to satisfying this Nasdaq listing condition. The Nasdaq listing condition in the Business Combination Agreement may be waived by the parties to the Business Combination Agreement.

### Holders

As of [ ], there was [ ] holders of record of Units, [ ] holders of record of Summit Public Shares, [ ] holders of record of Founder Shares and [ ] holders of record of Summit Warrants. As of [ ], there were [ ] holders of record of YS Biopharma's Ordinary Shares, [ ] holders of record of YS Biopharma's Series A Preferred Shares, [ ] holders of record of YS Biopharma's Series A Preferred Shares, [ ] holders of record of YS Biopharma's Series B Preferred Shares. See the section entitled "Beneficial Ownership of Securities."

### Dividend Policy

Summit has not paid any cash dividends on Summit Shares to date and does not intend to pay cash dividends prior to the completion of the Business Combination. In addition, YS Biopharma has not paid any dividends to its shareholders. The payment of any cash dividends after consummation of the Business Combination shall be dependent upon the revenue, earnings and financial condition of YS Biopharma from time to time. The payment of any dividends subsequent to the Business Combination shall be within the discretion of the board of directors of YS Biopharma.

## APPRAISAL RIGHTS

Holders of record of Summit Shares may have appraisal rights in connection with the Business Combination under the Cayman Islands Companies Act. In this proxy statement/prospectus, these appraisal or dissent rights are sometimes referred to as “Dissent Rights”.

Holders of record of Summit Shares wishing to exercise such Dissent Rights and make a demand for payment of the fair value for his, her or its Summit Shares must give written objection to the First Merger to Summit prior to the shareholder vote at the Extraordinary General Meeting to approve the First Merger and follow the procedures set out in Section 238 of the Cayman Islands Companies Act. These statutory appraisal rights are separate to and mutually exclusive of the right of Summit Public Shareholder to demand that their Summit Public Shares are redeemed for cash for a pro rata share of the funds on deposit in the Trust Account in accordance with the Summit Articles. It is possible that if a Summit Shareholder exercises appraisal rights, the fair value of the Summit Shares determined under Section 238 of the Cayman Islands Companies Act could be more than, the same as, or less than such holder would obtain they exercised their redemption rights as described herein. Summit believes that such fair value would equal the amount that Summit Public Shareholders would obtain if they exercise their redemption rights as described herein.

Summit Shareholders need not vote against any of the Proposals at the Extraordinary General Meeting in order to exercise Dissent Rights. A Summit Shareholder which elects to exercise Dissent Rights must do so in respect of all of the Summit Shares that person holds and will lose their right to exercise their redemption rights as described herein.

At the First Merger Effective Time, the Dissenting Summit Shares shall automatically be cancelled by virtue of the First Merger, and each Dissenting Summit Shareholder will thereafter cease to have any rights with respect to such shares, except the right to be paid the fair value of such shares and such other rights as are granted by the Cayman Islands Companies Act. Notwithstanding the foregoing, if any such holder shall have failed to perfect or withdraws or shall have otherwise lost his, her or its rights under Section 238 of the Cayman Islands Companies Act (including in the circumstances described in the immediately following paragraph) or a court of competent jurisdiction shall determine that such holder is not entitled to the relief provided by Section 238 of the Cayman Islands Companies Act, then the right of such holder to be paid the fair value of such holder’s Dissenting Summit Shares under Section 238 of the Cayman Islands Companies Act will cease, the shares will no longer be considered Dissenting Summit Shares and such holder’s former Summit Shares will thereupon be deemed to have been converted into, and to have become exchangeable for, as of the First Merger Effective Time, the right to receive the merger consideration comprising the number of newly issued YS Biopharma Ordinary Shares equal to the Class A Exchange Ratio for each Summit Share, without any interest thereon. As a result, such Summit shareholder would not receive any cash for their Summit Shares and would become a shareholder of YS Biopharma.

The Business Combination Agreement provides that, if any Summit shareholder exercises Dissent Rights then, unless Summit and YS Biopharma elect by agreement in writing otherwise, the completion of the First Merger shall be delayed in order to invoke the exemption under Section 239 of the Cayman Islands Companies Act. Section 239 of the Cayman Islands Companies Act states that no such dissenter rights shall be available in respect of shares of any class for which an open market exists on a recognized stock exchange or recognized interdealer quotation system at the expiry date of the period allowed for written notice of an election to dissent provided that the merger consideration constitutes inter alia shares of any company which at the effective date of the merger are listed on a national securities exchange. In circumstances where the limitation under Section 239 of the Cayman Islands Companies Act is invoked, no Dissent Rights would be available to Summit Shareholders, including those Summit Shareholders who previously delivered a written objection to the First Merger prior to the Extraordinary General Meeting and followed the procedures set out in Section 238 of the Cayman Islands Companies Act in full up to such date, and such holder’s former Summit Shares will thereupon be deemed to have been converted into, and to have become exchangeable for, as of the First Merger Effective Time, the right to receive the merger consideration comprising the number of newly issued YS Biopharma Ordinary Shares equal to the Class A Exchange Ratio for each Summit Share. Accordingly, Summit Shareholders are not expected to ultimately have any appraisal or dissent rights in respect of their Summit Shares and the certainty provided by the redemption process may be preferable for Summit Public Shareholders wishing to exchange their Summit Public Shares for cash.

**FUTURE SHAREHOLDER PROPOSALS AND NOMINATIONS**

If the Business Combination is consummated and you become a holder of YS Biopharma Ordinary Shares, you shall be entitled to attend and participate in YS Biopharma's annual meetings of shareholders. If YS Biopharma holds a annual meeting of shareholders, it shall provide notice of or otherwise publicly disclose the date on which the annual meeting shall be held. As a foreign private issuer, YS Biopharma shall not be subject to the SEC's proxy rules.

**SHAREHOLDER COMMUNICATIONS**

Shareholders and interested parties may communicate with Summit Board, any committee chairperson or the non-management directors as a group by writing to the board or committee chairperson in care of Summit, Unit 1101, 11th Floor 1 Lyndhurst Tower, 1 Lyndhurst Terrace Central, Hong Kong. Following the Business Combination, such communications should be sent in care of YS Biopharma, Building No. 2, 38 Yongda Road, Daxing Biomedical Industry Park Daxing District, Beijing, PRC or +86-10 8920-2086. Each communication shall be forwarded, depending on the subject matter, to the board of directors, the appropriate committee chairperson or all non-management directors.

**DELIVERY OF DOCUMENTS TO SHAREHOLDERS**

Pursuant to the rules of the SEC, Summit and services that it employs to deliver communications to its shareholders are permitted to deliver to two or more shareholders sharing the same address a single copy of each of Summit's annual report to shareholders and Summit's proxy statement. Upon written or oral request, Summit shall deliver a separate copy of the annual report and/or proxy statement to any shareholder at a shared address to which a single copy of each document was delivered and who wishes to receive separate copies of such documents. Shareholders receiving multiple copies of such documents may likewise request that Summit deliver single copies of such documents in the future. Shareholders may notify Summit of their requests by calling or writing Summit at +852-2155-7212 or Unit 1101, 11th Floor 1 Lyndhurst Tower, 1 Lyndhurst Terrace Central, Hong Kong. Following the Business Combination, such requests should be made by calling +86-10 8920-2086 or writing to YS Biopharma at Building No. 2, 38 Yongda Road, Daxing Biomedical Industry Park Daxing District, Beijing, PRC.



**TRANSFER AGENT AND REGISTRAR**

The transfer agent for Summit securities is Continental Stock Transfer & Trust Company, 1 State Street 30th Floor, New York, NY 10004-1561.

**WHERE YOU CAN FIND MORE INFORMATION**

As a foreign private issuer, after the consummation of the Business Combination, YS Biopharma shall be required to file its annual report on Form 20-F with the SEC no later than four months following its fiscal year end. Summit files reports, proxy statements and other information with the SEC as required by the Exchange Act. You may access information on Summit at the SEC web site containing reports, proxy statements and other information at: <http://www.sec.gov>.

Information and statements contained in this proxy statement/prospectus or any Annex to this proxy statement/prospectus are qualified in all respects by reference to the copy of the relevant contract or other Annex filed as an exhibit to this proxy statement/prospectus.

All information contained in this document relating to Summit has been supplied by Summit, and all such information relating to YS Biopharma has been supplied by YS Biopharma. Information provided by one entity does not constitute any representation, estimate or projection of the other entity.

YS Biopharma does not file any annual, quarterly or current reports, proxy statements or other information with the SEC.

**If you would like additional copies of this document or if you have questions about the Business Combination, you should contact via phone or in writing Summit's proxy solicitation agent at the following address, telephone number and email:**

Advantage Proxy, Inc.  
P.O. Box 13581  
Des Moines, WA 98198  
Attn: Karen Smith  
Toll Free Telephone: (877) 870-8565  
Collect Telephone: (206) 870-8565  
E-mail: [ksmith@advantageproxy.com](mailto:ksmith@advantageproxy.com)

If you are a Summit shareholder and would like to request documents, please do so by February 22, 2023 to receive them before the Summit Extraordinary General Meeting of shareholders. If you request any documents from Summit shall mail them to you by first class mail, or another equally prompt means.

None of Summit or YS Biopharma has authorized anyone to give any information or make any representation about the Business Combination or their companies that is different from, or in addition to, that which is contained in this proxy statement/prospectus or in any of the materials that have been incorporated in this proxy statement/prospectus. Therefore, if anyone does give you information of this sort, you should not rely on it. If you are in a jurisdiction where offers to exchange or sell, or solicitations of offers to exchange or purchase, the securities offered by this proxy statement/prospectus or the solicitation of proxies is unlawful, or if you are a person to whom it is unlawful to direct these types of activities, then the offer presented in this proxy statement/prospectus does not extend to you.

The information contained in this proxy statement/prospectus speaks only as of the date of this proxy statement/prospectus unless the information specifically indicates that another date applies.

**LEGAL MATTERS**

YS Biopharma is being represented by Wilson Sonsini Goodrich & Rosati, Professional Corporation with respect to certain legal matters as to United States federal securities and New York State law.

The validity of YS Biopharma Ordinary Shares has been passed on by Maples and Calder (Hong Kong) LLP, and the validity of YS Biopharma Warrants under New York law shall be passed on by Wilson Sonsini Goodrich & Rosati.

**EXPERTS**

The financial statements of Summit Healthcare Acquisition Corp. as of December 31, 2021 and 2020 and for the year ended December 31, 2021 and for the period from December 22, 2020 (inception) through December 31, 2020, appearing in this proxy statement/prospectus have been audited by WithumSmith+Brown, PC, independent registered public accounting firm, as set forth in their report thereon, appearing elsewhere in this proxy statement/prospectus, and are included in reliance upon such report given on the authority of such firm as experts in accounting and auditing.

The consolidated balance sheets of YishengBio Co., Ltd as of March 31, 2021 and 2022, and the related consolidated statements of operations and other comprehensive loss, changes in shareholder's equity and cash flows for each of the years in the two-year period ended March 31, 2022, and the related notes have been included herein in reliance upon the report of Wei, Wei & Co., LLP, an independent registered public accounting firm, appearing elsewhere herein, and upon the authority of said firm as experts in accounting and auditing.

**SUMMIT HEALTHCARE ACQUISITION CORP.  
INDEX TO CONSOLIDATED FINANCIAL STATEMENTS**

<b>CONTENTS</b>	<b>Page(s)</b>
<a href="#"><u>Condensed Balance Sheets as of September 30, 2022 (Unaudited) and December 31, 2021</u></a>	<a href="#"><u>F-2</u></a>
<a href="#"><u>Unaudited Condensed Statements of Operations for the Three and Nine Months Ended September 30, 2022 and 2021</u></a>	<a href="#"><u>F-3</u></a>
<a href="#"><u>Unaudited Condensed Statements of Changes in Shareholders' Deficit for the Three and Nine Months Ended September 30, 2022</u></a>	<a href="#"><u>F-4</u></a>
<a href="#"><u>Unaudited Condensed Statements of Changes in Shareholders' Equity (Deficit) for the Three and Nine Months Ended September 30, 2021</u></a>	<a href="#"><u>F-5</u></a>
<a href="#"><u>Unaudited Condensed Statements of Cash Flows for the Nine Months Ended September 30, 2022 and 2021</u></a>	<a href="#"><u>F-6</u></a>
<a href="#"><u>Notes to Unaudited Condensed Financial Statements</u></a>	<a href="#"><u>F-7</u></a>
<a href="#"><u>Report of Independent Registered Public Accounting Firm (PCAOB ID 100)</u></a>	<a href="#"><u>F-23</u></a>
<b>Financial Statements</b>	
<a href="#"><u>Balance Sheets as of December 31, 2021 and 2020</u></a>	<a href="#"><u>F-24</u></a>
<a href="#"><u>Statements of Operations for the Year ended December 31, 2021 and for the Period from December 22, 2020 (Inception) through December 31, 2020</u></a>	<a href="#"><u>F-25</u></a>
<a href="#"><u>Statement of Changes in Shareholders' Equity for the Year Ended December 31, 2021 and for the period from December 22, 2020 (Inception) through December 31, 2020</u></a>	<a href="#"><u>F-26</u></a>
<a href="#"><u>Statements of Cash Flows for the Year ended December 31, 2021 and for the Period from December 22, 2020 (Inception) through December 31, 2020</u></a>	<a href="#"><u>F-27</u></a>
<a href="#"><u>Notes to Financial Statements</u></a>	<a href="#"><u>F-28</u></a>

**YISHENGBIO CO., LTD AND SUBSIDIARIES  
INDEX TO CONSOLIDATED FINANCIAL STATEMENTS**

<b>CONTENTS</b>	<b>Page(s)</b>
<a href="#"><u>Report of Independent Registered Public Accounting Firm (PCAOB ID 2388)</u></a>	<a href="#"><u>F-42</u></a>
<a href="#"><u>Consolidated Balance Sheets as of March 31, 2022 and 2021</u></a>	<a href="#"><u>F-43</u></a>
<a href="#"><u>Consolidated Statements of Operations and Comprehensive Loss for the Years Ended March 31, 2022 and 2021</u></a>	<a href="#"><u>F-45</u></a>
<a href="#"><u>Consolidated Statements of Changes in Shareholders' Deficit for the Years Ended March 31, 2022 and 2021</u></a>	<a href="#"><u>F-46</u></a>
<a href="#"><u>Consolidated Statements of Cash Flows for the Years Ended March 31, 2022 and 2021</u></a>	<a href="#"><u>F-47</u></a>
<a href="#"><u>Notes to the Consolidated Financial Statements</u></a>	<a href="#"><u>F-48</u></a>
<a href="#"><u>Condensed Consolidated Balance Sheets as of September 30, 2022 (Unaudited) and March 31, 2022</u></a>	<a href="#"><u>F-81</u></a>
<a href="#"><u>Unaudited Condensed Consolidated Statements of Operations and Comprehensive Loss for the Six Months Ended September 30, 2022 and 2021</u></a>	<a href="#"><u>F-82</u></a>
<a href="#"><u>Unaudited Condensed Consolidated Statements of Changes in Shareholders' Deficit for the Six Months Ended September 30, 2022 and 2021</u></a>	<a href="#"><u>F-83</u></a>
<a href="#"><u>Unaudited Condensed Consolidated Statements of Cash Flows for the Six Months Ended September 30, 2022 and 2021</u></a>	<a href="#"><u>F-84</u></a>
<a href="#"><u>Notes to Unaudited Condensed Consolidated Financial Statements</u></a>	<a href="#"><u>F-85</u></a>

**SUMMIT HEALTHCARE ACQUISITION CORP.**  
**CONDENSED BALANCE SHEETS**

	September 30, 2022	December 31, 2021
	(unaudited)	
<b>Assets</b>		
Current assets:		
Cash	\$ 70,097	\$ 885,198
Prepaid expenses	218,545	141,677
<b>Total current assets</b>	<b>288,642</b>	<b>1,026,875</b>
Investments held in Trust Account	201,200,243	200,007,275
<b>Total Assets</b>	<b>\$201,488,885</b>	<b>\$201,034,150</b>
<b>Liabilities, Class A Ordinary Shares Subject to Possible Redemption and Shareholders' Deficit</b>		
Current liabilities:		
Accrued expenses	\$ 599,956	\$ 142,631
Due to related party	30,000	—
<b>Total current liabilities</b>	<b>629,956</b>	<b>142,631</b>
FPA liability	3,209,928	2,785,941
Warrant liability	2,414,882	10,423,429
Deferred underwriting commissions	—	7,000,000
<b>Total Liabilities</b>	<b>6,254,766</b>	<b>20,352,001</b>
<b>Commitments and Contingencies (Note 7)</b>		
Class A ordinary shares subject to possible redemption, \$0.0001 par value; 20,000,000 shares issued and outstanding at redemption value of \$10.06 and \$10.00 per share, as of September 30, 2022 and December 31, 2021, respectively	201,200,243	200,000,000
<b>Shareholders' Deficit</b>		
Preference shares, \$0.0001 par value; 5,000,000 shares authorized; none issued or outstanding	—	—
Class A ordinary shares, \$0.0001 par value; 500,000,000 shares authorized; 20,000,000 shares issued and outstanding as of September 30, 2022 and December 31, 2021, all of which are subject to possible redemption	—	—
Class B ordinary shares, \$0.0001 par value; 50,000,000 shares authorized; 5,750,000 shares issued and outstanding as of September 30, 2022 and December 31, 2021	575	575
Accumulated deficit	(5,966,699)	(19,318,426)
<b>Total shareholders' Deficit</b>	<b>(5,966,124)</b>	<b>(19,317,851)</b>
<b>Total Liabilities, Class A Ordinary Shares Subject to Possible Redemption and Shareholders' Deficit</b>	<b>\$201,488,885</b>	<b>\$201,034,150</b>

The accompanying notes are an integral part of the condensed financial statements.

**SUMMIT HEALTHCARE ACQUISITION CORP.**  
**UNAUDITED CONDENSED STATEMENTS OF OPERATIONS**

	Three Months Ended September 30,		Nine Months Ended September 30,	
	2022	2021	2022	2021
General and administrative expenses	\$ 581,189	\$ 202,904	\$ 1,225,560	\$ 246,868
<b>Loss from operations</b>	<b>(581,189)</b>	<b>(202,904)</b>	<b>(1,225,560)</b>	<b>(246,868)</b>
Other income (expense):				
Change in fair value of FPA	(409,888)	(561,983)	(423,987)	(2,807,021)
Change in fair value of warrant liability	(1,206,319)	1,797,111	8,008,547	(88,010)
Transaction costs allocable to warrants	—	—	—	(507,417)
Interest earned on investments held in Trust Account	902,750	2,573	1,192,968	3,049
Gain recognized on extinguishment of deferred underwriting commissions	7,000,000	—	7,000,000	—
Total other income (expense), net	6,286,543	1,237,701	15,777,528	(3,399,399)
<b>Net income (loss)</b>	<b>\$ 5,705,354</b>	<b>\$ 1,034,797</b>	<b>\$14,551,968</b>	<b>\$ (3,646,267)</b>
Basic and diluted weighted average shares outstanding, Class A ordinary shares	20,000,000	20,000,000	20,000,000	8,205,128
<b>Basic and diluted net income (loss) per share, Class A ordinary shares subject to possible redemption</b>	<b>\$ 0.22</b>	<b>\$ 0.04</b>	<b>\$ 0.57</b>	<b>\$ (0.26)</b>
Basic and diluted weighted average shares outstanding, Class B ordinary shares	5,750,000	5,750,000	5,750,000	5,750,000
<b>Basic and diluted net income (loss) per share, Class B ordinary shares</b>	<b>\$ 0.22</b>	<b>\$ 0.04</b>	<b>\$ 0.57</b>	<b>\$ (0.26)</b>

The accompanying notes are an integral part of the condensed financial statements.

**SUMMIT HEALTHCARE ACQUISITION CORP.**  
**UNAUDITED CONDENSED STATEMENTS OF CHANGES IN SHAREHOLDERS' DEFICIT**  
**FOR THE THREE AND NINE MONTHS ENDED SEPTEMBER 30, 2022**

	Class A Ordinary Shares		Class B Ordinary Shares		Additional Paid-in Capital	Accumulated Deficit	Total Shareholders' Deficit
	Shares	Amount	Shares	Amount			
<b>Balance as of December 31, 2021</b>	—	\$ —	5,750,000	\$575	\$ —	\$(19,318,426)	\$(19,317,851)
Net income	—	—	—	—	—	7,126,838	7,126,838
<b>Balance as of March 31, 2022</b>	—	—	5,750,000	575	\$ —	(12,191,588)	(12,191,013)
Net income	—	—	—	—	—	1,719,777	1,719,777
Accretion of carrying value to redemption value-interest	—	—	—	—	—	(297,492)	(297,492)
<b>Balance as of June 30, 2022</b>	—	—	5,750,000	575	\$ —	(10,769,303)	(10,768,728)
Net income	—	—	—	—	—	5,705,354	5,705,354
Accretion of carrying value to redemption value-interest	—	—	—	—	—	(902,750)	(902,750)
<b>Balance as of September 30, 2022</b>	—	\$ —	5,750,000	\$575	\$ —	\$(5,966,699)	\$(5,966,124)

The accompanying notes are an integral part of the condensed financial statements.



**SUMMIT HEALTHCARE ACQUISITION CORP.**  
**UNAUDITED CONDENSED STATEMENTS OF CHANGES IN SHAREHOLDERS' EQUITY (DEFICIT)**  
**FOR THE THREE AND NINE MONTHS ENDED SEPTEMBER 30, 2021**

	Class A Ordinary Shares		Class B Ordinary Shares		Additional Paid-in Capital	Accumulated Deficit	Total Shareholders' Equity (Deficit)
	Shares	Amount	Shares	Amount			
<b>Balance as of December 31, 2020</b>	—	\$ —	6,500,000	\$650	\$ 24,350	\$ (3,636)	\$ 21,364
Net loss	—	—	—	—	—	—	—
<b>Balance as of March 31, 2021</b>	—	—	6,500,000	650	24,350	(3,636)	21,364
Accretion of Class A ordinary shares to redemption value	—	—	—	—	(24,350)	(18,769,138)	(18,793,488)
Net loss	—	—	—	—	—	(4,681,064)	(4,681,064)
<b>Balance as of June 30, 2021</b>	—	—	6,500,000	650	—	(23,453,838)	(23,453,188)
Forfeiture of founder shares	—	—	(750,000)	(75)	—	75	—
Net loss	—	—	—	—	—	1,034,797	1,034,797
<b>Balance as of September 30, 2021</b>	—	\$ —	5,750,000	\$575	\$ —	\$ (22,418,966)	\$ (22,418,391)

The accompanying notes are an integral part of the condensed financial statements.

**SUMMIT HEALTHCARE ACQUISITION CORP.**  
**UNAUDITED CONDENSED STATEMENTS OF CASH FLOWS**

	For the Nine Months ended September 30, 2022	For the Nine Months ended September 30, 2021
<b>Cash Flows from Operating Activities:</b>		
Net income (loss)	\$14,551,968	\$ (3,646,267)
Adjustments to reconcile net income (loss) to net cash used in operating activities:		
Interest earned on investments held in Trust Account	(1,192,968)	(3,049)
Change in fair value of FPA liability	423,987	2,807,021
Change in fair value of warrant liability	(8,008,547)	88,010
Transaction costs allocable to warrants	—	507,417
Gain recognized on extinguishment of deferred underwriting commissions	(7,000,000)	—
Changes in operating assets and liabilities:		
Prepaid expenses	(76,868)	(221,704)
Accrued offering costs and expenses	457,327	7,619
Due to related party	30,000	37,667
<b>Net cash used in operating activities</b>	<b>(815,101)</b>	<b>(423,286)</b>
<b>Cash Flows from Investing Activities</b>		
Investment of cash in Trust Account	—	(200,000,000)
<b>Net cash used in investing activities</b>	<b>—</b>	<b>(200,000,000)</b>
<b>Cash Flows from Financing Activities:</b>		
Proceeds received from initial public offering, net of underwriters' discount	—	196,000,000
Proceeds from private placement	—	6,000,000
Payment of offering costs	—	(140,554)
Repayment of note payable from related party	—	(361,023)
<b>Net cash provided by financing activities</b>	<b>—</b>	<b>201,498,423</b>
<b>Net change in cash</b>	<b>(815,101)</b>	<b>1,075,137</b>
Cash, beginning of the period	885,198	
<b>Cash, end of the period</b>	<b>\$ 70,097</b>	<b>\$ 1,075,137</b>
<b>Supplemental disclosure of non-cash investing and financing activity</b>		
Deferred offering costs paid by Sponsor under promissory note	\$ —	\$ 135,544
Deferred underwriting commissions charged to additional paid in capital	\$ —	\$ 7,000,000

The accompanying notes are an integral part of the condensed financial statements.

**SUMMIT HEALTHCARE ACQUISITION CORP.**  
**NOTES TO UNAUDITED CONDENSED FINANCIAL STATEMENTS**

**Note 1 — Organization, Business Operation, Liquidity and Capital Resources**

Summit Healthcare Acquisition Corp. (the “Company”) is a blank check company incorporated on December 22, 2020 as a Cayman Islands exempted company. The Company was incorporated for the purpose of effecting a merger, share exchange, asset acquisition, share purchase, reorganization or similar business combination with one or more businesses (the “Business Combination”). The Company has not selected any specific Business Combination target under consideration or contemplation and the Company has not, nor has anyone on its behalf, contacted any prospective target business or had any discussions, formal or otherwise, with respect to such a transaction. The Company’s efforts to identify a prospective target business will not be limited to a particular geographic region or industry, although it intends to focus on healthcare.

As of September 30, 2022, the Company had not commenced any operations. All activity for the period from December 22, 2020 (inception) through September 30, 2022 relates to the Company’s formation and the initial public offering (the “IPO”), searching for a Business Combination target. The Company will not generate any operating revenues until after the completion of its initial Business Combination, at the earliest. The Company generates non-operating income in the form of interest income on investments from the proceeds derived from the IPO. The Company has selected December 31 as its fiscal year end.

The Company’s Sponsor is Summit Healthcare Acquisition Sponsor LLC, a Cayman Islands limited liability company (the “Sponsor”). The registration statement for the Company’s IPO was declared effective on June 8, 2021 (the “Effective Date”). On June 11, 2021, the Company consummated the IPO of 20,000,000 units (the “Units” and, with respect to the Class A ordinary shares included in the Units being offered, the “Public Shares”) \$10.00 per Unit, generating gross proceeds of \$200,000,000, which is discussed in Note 3.

Simultaneously with the consummation of the IPO and the issuance and sale of the Units, the Company consummated the private placement of 6,000,000 Private Placement Warrants (the “Private Placement Warrants”) at a price of \$1.00 per Private Placement Warrant, to the Sponsor, generating total proceeds of \$6,000,000. Transaction costs amounted to \$11,587,941 consisting of \$4,000,000 of underwriting commissions, \$7,000,000 of deferred underwriting commissions and \$587,941 of other cash offering costs.

Following the closing of the IPO on June 11, 2021, \$200,000,000 (\$10.00 per Unit) from the net proceeds of the sale of the Units in the IPO and the sale of the Private Placement Warrants was placed in a U.S.-based trust account (the “Trust Account”) with Continental Stock Transfer & Trust Company acting as trustee, and was invested only in U.S. government treasury bills with a maturity of 185 days or less or in money market funds investing solely in U.S. Treasuries and meeting certain conditions under Rule 2a-7 under the Investment Company Act. As of September 30, 2022, the assets held in the Trust Account were held in money market fund.

Except with respect to interest earned on the funds held in the Trust Account that may be released to the Company to pay its income taxes, if any, the Company’s amended and restated memorandum and articles of association and subject to the requirements of law and regulation, will provide that the proceeds from the IPO and the sale of the Private Placement Warrants held in the Trust Account will not be released from the Trust Account (1) to the Company, until the completion of the initial Business Combination, or (2) to the Company’s public shareholders until the earliest of: (i) the completion of an initial Business Combination, and then only in connection with those Class A ordinary shares that such shareholders properly elected to redeem, (ii) the redemption of any public shares properly tendered in connection with a shareholder vote to amend the Company’s amended and restated memorandum and articles of association, and (iii) the redemption of the Company’s public shares if the Company has not consummated its Business Combination within 24 months from the closing of the IPO, subject to applicable law.

The ordinary shares subject to redemption are recorded at a \$10.06 per share redemption value and classified as temporary equity, in accordance with Accounting Standards Codification (“ASC”) Topic 480 “Distinguishing Liabilities from Equity.”

The Company will have 24 months from the closing of the IPO to complete the initial Business Combination (the “Combination Period”) or during any Extension Period. However, if the Company is unable to complete

the initial Business Combination within the Combination Period, the Company will (i) cease all operations except for the purpose of winding up, (ii) as promptly as reasonably possible but not more than ten business days thereafter, redeem the public shares, at a per-share price, payable in cash, equal to the aggregate amount then on deposit in the Trust Account, including interest earned on the funds held in the Trust Account and not previously released to the Company to pay its income taxes, if any (less up to \$100,000 of interest to pay dissolution expenses), divided by the number of the then outstanding public shares, which redemption will completely extinguish public shareholders' rights as shareholders (including the right to receive further liquidation distributions, if any), and (iii) as promptly as reasonably possible following such redemption, subject to the approval of the Company's remaining shareholders and the Company's board of directors, liquidate and dissolve, subject in each case to the Company's obligations under Cayman Islands law to provide for claims of creditors and the requirements of other applicable law.

The Sponsor and the Company's officers and directors agreed to (i) waive their redemption rights with respect to their Class B ordinary shares, par value \$0.0001 (the "Founder Shares") in connection with the completion of the initial Business Combination, (ii) waive their redemption rights with respect to their Founder Shares and public shares in connection with a shareholder vote to approve an amendment to the Company's amended and restated memorandum and articles of association, (iii) waive their rights to liquidating distributions from the Trust Account with respect to any Founder Shares they hold if the Company fails to complete the initial Business Combination within the Combination Period or during any Extension Period (although they will be entitled to liquidating distributions from the Trust Account with respect to any public shares they hold if the Company fails to complete its initial Business Combination within the prescribed timeframe), and (iv) vote any Founder Shares and public shares held by them in favor of the initial Business Combination.

The Sponsor has agreed that it will be liable to the Company if and to the extent any claims by a third party (other than the Company's independent registered public accounting firm) for services rendered or products sold to the Company, or a prospective target business with which the Company has discussed entering into a transaction agreement, reduce the amounts in the Trust Account to below the lesser of (i) \$10.00 per public share or (ii) the actual amount per public share held in the Trust Account as of the date of the liquidation of the Trust Account if less than \$10.00 per public share due to reductions in the value of the trust assets, in each case net of the interest that may be withdrawn to pay the Company's tax obligations, provided that such liability will not apply to any claims by a third party or prospective target business that executed a waiver of any and all rights to seek access to the Trust Account nor will it apply to any claims under the Company's indemnity of the underwriter of the IPO against certain liabilities, including liabilities under the Securities Act. However, the Company has not asked its Sponsor to reserve for such indemnification obligations, nor has the Company independently verified whether its Sponsor has sufficient funds to satisfy its indemnity obligations and the Company believes that the Sponsor's only assets are securities of the Company. Therefore, the Company cannot assure you that the Sponsor would be able to satisfy those obligations. None of the Company's officers or directors will indemnify the Company for claims by third parties including, without limitation, claims by vendors and prospective target businesses.

### **Business Combination**

On September 29, 2022, the Company entered into a Business Combination Agreement (the "Business Combination Agreement") with YishengBio Co., Ltd., an exempted company limited by shares incorporated under the laws of the Cayman Islands (to be renamed as YS Biopharma Co., Ltd, herein referred to as "YS Biopharma"), Oceanview Bioscience Acquisition Co., Ltd., an exempted company limited by shares incorporated under the laws of the Cayman Islands and a direct wholly-owned subsidiary of YS Biopharma ("Merger Sub I") and Hudson Biomedical Group Co., Ltd., an exempted company limited by shares incorporated under the laws of the Cayman Islands and a direct wholly-owned subsidiary of YS Biopharma ("Merger Sub II," and together with Merger Sub I, "Merger Subs").

The Business Combination Agreement provides for (i) the merger of Merger Sub I with and into the Company (the "First Merger"), with the Company surviving the First Merger as the surviving entity (the "Surviving Entity") and becoming a wholly-owned subsidiary of YS Biopharma, and (ii) the merger of the Surviving Entity with and into Merger Sub II (the "Second Merger," and together with the First Merger, the "Mergers," together with other transactions contemplated by the Business Combination Agreement, the "Transactions"), with Merger Sub II surviving the Second Merger as the surviving company (the "Surviving Company") and remaining as the wholly-owned subsidiary of YS Biopharma.

**Liquidity and Capital Resources; Going Concern**

As of September 30, 2022, the Company had \$70,097 of cash for working capital purposes and a working capital deficit of \$341,314.

The Company's liquidity needs prior to the IPO had been satisfied through a payment from the Sponsor of \$25,000 (see Note 5) for the Founder Shares to cover certain offering costs and the loan under an unsecured promissory note from the Sponsor of \$300,000 (see Note 5).

The promissory note was repaid on June 11, 2021. In addition, in order to finance transaction costs in connection with a Business Combination, the Company's Sponsor or an affiliate of the Sponsor or certain of the Company's officers and directors may, but are not obligated to, provide the Company Working Capital Loans, as defined below (see Note 5). As of September 30, 2022 and December 31, 2021, there were no amounts outstanding under any Working Capital Loans.

The Company has incurred and expects to continue to incur significant costs in pursuit of its financing and acquisition plans. The Company may need to raise additional capital through loans or additional investments from its Sponsor, shareholders, officers, directors, or third parties. The Company's officers, directors and Sponsor may, but are not obligated to, loan the Company funds, from time to time or at any time, in whatever amount they deem reasonable in their sole discretion, to meet the Company's working capital needs. Accordingly, the Company may not be able to obtain additional financing. If the Company is unable to raise additional capital, it may be required to take additional measures to conserve liquidity, which could include, but not necessarily be limited to, curtailing operations, suspending the pursuit of a potential transaction, and reducing overhead expenses. The Company cannot provide any assurance that new financing will be available to it on commercially acceptable terms, if at all. On September 29, 2022, the Company issued a Convertible Promissory Note (as described in Note 6) to the Sponsor, pursuant to which, the Company may borrow up to \$1,500,000 from the Sponsor for working capital purposes. On October 12, 2022, the Company had drew down \$700,000 under the Convertible Promissory Note.

The Company has until June 11, 2023 to consummate a Business Combination. It is uncertain that the Company will be able to consummate a Business Combination by such date. If a Business Combination is not consummated by the required date, the Company will commence an automatic winding up, dissolution and liquidation. In connection with the Company's assessment of going concern considerations in accordance with Financial Accounting Standard Board's Accounting Standards Update ("ASU") 2014-15, "Disclosures of Uncertainties about an Entity's Ability to Continue as a Going Concern," the management has determined that the liquidity condition and mandatory liquidation, should a Business Combination not occur, and potential subsequent dissolution raises substantial doubt about the Company's ability to continue as a going concern. No adjustments have been made to the carrying amounts of assets or liabilities should the Company be required to liquidate after June 11, 2023. The management plans to continue efforts to close a Business Combination within the prescribed time frame.

**Note 2 — Significant Accounting Policies****Basis of Presentation**

The accompanying unaudited condensed financial statements of the Company are presented in conformity with accounting principles generally accepted in the United States of America ("US GAAP") for interim financial information and in accordance with the instructions to Form 10-Q and pursuant to the rules and regulations of the Security and Exchange Commission ("SEC"). Certain information or footnote disclosures normally included in financial statements prepared in accordance with US GAAP have been condensed or omitted, pursuant to the rules and regulations of the SEC for interim financial reporting. Accordingly, they do not include all the information and footnotes necessary for a complete presentation of financial position, results of operations, or cash flows. In the opinion of management, the accompanying unaudited condensed financial statements include all adjustments, consisting of a normal recurring nature, which are necessary for a fair presentation of the financial position, operating results and cash flows for the periods presented.

The interim results for the three and nine months ended September 30, 2022 are not necessarily indicative of the results to be expected for the year ending December 31, 2022 or for any future interim periods.

**Emerging Growth Company Status**

The Company is an “emerging growth company,” as defined in Section 2(a) of the Securities Act of 1933, as amended, (the “Securities Act”), as modified by the Jumpstart our Business Startups Act of 2012, (the “JOBS Act”), and it may take advantage of certain exemptions from various reporting requirements that are applicable to other public companies that are not emerging growth companies including, but not limited to, not being required to comply with the auditor attestation requirements of Section 404 of the Sarbanes-Oxley Act, reduced disclosure obligations regarding executive compensation in its periodic reports and proxy statements, and exemptions from the requirements of holding a nonbinding advisory vote on executive compensation and shareholder approval of any golden parachute payments not previously approved.

Further, Section 102(b)(1) of the JOBS Act exempts emerging growth companies from being required to comply with new or revised financial accounting standards until private companies (that is, those that have not had a Securities Act registration statement declared effective or do not have a class of securities registered under the Exchange Act) are required to comply with the new or revised financial accounting standards. The JOBS Act provides that a company can elect to opt out of the extended transition period and comply with the requirements that apply to non-emerging growth companies but any such election to opt out is irrevocable. The Company has elected not to opt out of such extended transition period which means that when a standard is issued or revised and it has different application dates for public or private companies, the Company, as an emerging growth company, can adopt the new or revised standard at the time private companies adopt the new or revised standard. This may make comparison of the Company’s financial statements with another public company which is neither an emerging growth company nor an emerging growth company which has opted out of using the extended transition period difficult or impossible because of the potential differences in accounting standards used.

**Use of Estimates**

The preparation of the unaudited condensed financial statements in conformity with US GAAP requires management to make estimates and assumptions that affect the reported amounts of assets and liabilities and disclosure of contingent assets and liabilities at the date of the unaudited condensed financial statements and the reported amounts of expenses during the reporting period.

Making estimates requires management to exercise significant judgement. It is at least reasonably possible that the estimate of the effect of a condition, situation or set of circumstances that existed at the date of the unaudited condensed financial statements, which management considered in formulating its estimate, could change in the near term due to one or more future confirming events. One of the more significant estimates included in these financial statements is the determination of the fair value of the warrant liability and Forward Purchase Agreement (“FPA”) liability.

**Cash and Cash Equivalents**

The Company considers all short-term investments with an original maturity of three months or less when purchased to be cash equivalents. The Company did not have cash equivalents as of September 30, 2022 and December 31, 2021.

**Investments Held in Trust Account**

As of September 30, 2022 and December 31, 2021, the assets held in the Trust Account were held in a money market fund. The Company’s portfolio of investments held in the Trust Account is comprised of U.S. government securities, within the meaning set forth in Section 2(a)(16) of the Investment Company Act, with a maturity of 185 days or less, investments in money market funds that invest in U.S. government securities, cash, or a combination thereof. The Company’s investments held in the Trust Account are classified as trading securities. Trading securities are presented on the condensed balance sheets at fair value at the end of each reporting period. Interest earned on these securities is included in interest earned on Investments Held in Trust Account in the accompanying unaudited condensed statements of operations. The estimated fair value of investments held in the Trust Account is determined using available market information. As of September 30, 2022 and December 31, 2021, the Company had \$201,200,243 and \$200,007,275 held in the Trust Account, respectively.

### **Concentration of Credit Risk**

Financial instruments that potentially subject the Company to concentrations of credit risk consist of a cash account in a financial institution, which, at times, may exceed the Federal Depository Insurance Corporation limit of \$250,000. As of September 30, 2022 and December 31, 2021, the Company has not experienced losses on this account and management believes the Company is not exposed to significant risks on such account.

### **Offering Costs Associated with IPO**

The Company complies with the requirements of the ASC340-10-S99-1 and SEC Staff Accounting Bulletin (“SAB”) Topic 5A “Expenses of Offering”. Offering costs consist principally of professional and registration fees incurred through the balance sheet date that are related to the Public Offering. Offering costs are charged to ordinary shares subject to possible redemption or the statement of operations based on the relative value of the Public and Private Warrants to the proceeds received from the Units and Private Placement Warrants sold upon the completion of the IPO. Accordingly, offering costs totaling \$11,587,941 (consisting of \$4,000,000 of underwriting fees, \$7,000,000 of deferred underwriting fees and \$587,941 of other offering costs), of which \$507,417 was allocated to the Public Warrants and Private Warrants and was charged to operations in accordance with ASC 825-10 and \$11,080,524 was charged to ordinary shares subject to possible redemption.

### **Derivative Financial Instruments**

The Company evaluates its financial instruments to determine if such instruments are derivatives or contain features that qualify as embedded derivatives in accordance with ASC Topic 815, “Derivatives and Hedging”. For derivative financial instruments that are accounted for as liabilities, the derivative instrument is initially recorded at its fair value on the grant date and is then re-valued at each reporting date, with changes in the fair value reported in the statements of operations. The classification of derivative instruments, including whether such instruments should be recorded as liabilities or as equity, is evaluated at the end of each reporting period. Derivative liabilities are classified in the balance sheet as current or non-current based on whether or not net-cash settlement or conversion of the instrument could be required within 12 months of the balance sheet date.

### **Warrant Liability and Forward Purchase Agreement**

The Company accounts for the 16,000,000 warrants issued in connection with the IPO (the 10,000,000 Public Warrants and the 6,000,000 Private Placement Warrants) and Forward Purchase Agreement (“FPA”) in accordance with the guidance contained in FASB ASC 815 “Derivatives and Hedging” whereby under that provision the warrants and FPA do not meet the criteria for equity treatment and must be recorded as liabilities. Accordingly, the Company will classify warrants and FPA as liabilities at their fair value. These liabilities are subject to re-measurement at each reporting period. With such re-measurement, the changes in fair value are recognized in the Statement of Operations in the period of change. Derivative warrant liabilities and FPA are classified as non-current liabilities as their liquidation is not reasonably expected to require the use of current assets or require the creation of current liabilities.

### **Fair Value Measurements**

The fair value of the Company’s assets and liabilities, excluding the warrant liability and FPA liability, which qualify as financial instruments under FASB ASC Topic 820, “Fair Value Measurement” (“ASC 820”), approximates the carrying amounts represented in the accompanying condensed balance sheets, primarily due to their short-term nature.

Fair value is defined as the price that would be received for sale of an asset or paid to transfer of a liability, in an orderly transaction between market participants at the measurement date. US GAAP establishes a three-tier fair value hierarchy, which prioritizes the inputs used in measuring fair value. The hierarchy gives the highest priority to unadjusted quoted prices in active markets for identical assets or liabilities (Level 1 measurements) and the lowest priority to unobservable inputs (Level 3 measurements). These tiers include:

- Level 1, defined as observable inputs such as quoted prices (unadjusted) for identical instruments in active markets;

- Level 2, defined as inputs other than quoted prices in active markets that are either directly or indirectly observable such as quoted prices for similar instruments in active markets or quoted prices for identical or similar instruments in markets that are not active; and
- Level 3, defined as unobservable inputs in which little or no market data exists, therefore requiring an entity to develop its own assumptions, such as valuations derived from valuation techniques in which one or more significant inputs or significant value drivers are unobservable.

In some circumstances, the inputs used to measure fair value might be categorized within different levels of the fair value hierarchy. In those instances, the fair value measurement is categorized in its entirety in the fair value hierarchy based on the lowest level input that is significant to the fair value measurement.

#### **Class A Ordinary Shares Subject to Possible Redemption**

The Company accounts for its Class A ordinary shares subject to possible redemption in accordance with the guidance in ASC Topic 480 “Distinguishing Liabilities from Equity.” Ordinary shares subject to mandatory redemption (if any) are classified as a liability instrument and measured at fair value. Conditionally redeemable ordinary shares (including ordinary shares that feature redemption rights that are either within the control of the holder or subject to redemption upon the occurrence of uncertain events not solely within the Company’s control) are classified as temporary equity. At all other times, ordinary shares are classified as shareholders’ equity. The Company’s Class A ordinary shares feature certain redemption rights that are considered to be outside of the Company’s control and subject to the occurrence of uncertain future events. Accordingly, as of September 30, 2022 and December 31, 2021, 20,000,000 and 20,000,000 Class A ordinary shares, respectively, subject to possible redemption are presented at redemption value as temporary equity, outside of the shareholders’ equity (deficit) section of the Company’s balance sheet.

The Company recognizes changes in redemption value immediately as they occur and adjusts the carrying value of redeemable ordinary shares to equal the redemption value at the end of each reporting period.

As of September 30, 2022 and December 31, 2021, the Class A ordinary shares subject to possible redemption reflected in the condensed balance sheets are reconciled in the following table:

Gross proceeds	\$200,000,000
Less: Proceeds allocated to Public Warrants	(8,511,409)
Less: Class A ordinary shares issuance costs	(11,080,524)
Add: Accretion of carrying value to redemption value	19,591,933
Class A ordinary shares subject to possible redemption as of December 31, 2021	200,000,000
Add: Accretion of carrying value to redemption value	1,200,243
Class A ordinary shares subject to possible redemption as of September 30, 2022	<u>\$201,200,243</u>

#### **Net Income (Loss) Per Ordinary Share**

The Company has two classes of shares, which are referred to as Class A ordinary shares and Class B ordinary shares. Earnings and losses are shared pro rata between the two classes of shares. The 16,000,000 potential ordinary shares for outstanding warrants to purchase the Company’s stock were excluded from diluted earnings per share for the three and nine months ended September 30, 2022 and 2021, because the warrants are contingently exercisable, and the contingencies have not yet been met. As a result, diluted net income (loss) per ordinary share is the same as basic net income (loss) per ordinary share for the periods. The table below presents a reconciliation of the numerator and denominator used to compute basic and diluted net income (loss) per share for each class of ordinary shares:



	For the Three Months Ended September 30,			
	2022		2021	
	Class A	Class B	Class A	Class B
Basic and diluted net income per share:				
Numerator:				
Allocation of net income	\$ 4,431,344	\$ 1,274,011	\$ 803,726	\$ 231,071
Denominator:				
Weighted-average shares outstanding	20,000,000	5,750,000	20,000,000	5,750,000
Basic and diluted net income per share	\$ 0.22	\$ 0.22	\$ 0.04	\$ 0.04

	For the Nine Months Ended September 30,			
	2022		2021	
	Class A	Class B	Class A	Class B
Basic and diluted net income (loss) per share:				
Numerator:				
Allocation of net income (loss)	\$11,302,500	\$3,249,469	\$(2,143,878)	\$(1,502,389)
Denominator:				
Weighted-average shares outstanding	20,000,000	5,750,000	8,205,128	5,750,000
Basic and diluted net income (loss) per share	\$ 0.57	\$ 0.57	\$ (0.26)	\$ (0.26)

### Income Taxes

ASC 740 clarifies the accounting for uncertainty in income taxes recognized in a Company's financial statements and prescribes a recognition threshold and measurement process for financial statement recognition and measurement of a tax position taken or expected to be taken in a tax return. For those benefits to be recognized, a tax position must be more-likely-than-not to be sustained upon examination by taxing authorities. ASC 740 also provides guidance on derecognition, classification, interest and penalties, accounting in interim period, disclosure and transition.

There is currently no taxation imposed on income by the Government of the Cayman Islands. In accordance with Cayman federal income tax regulations, income taxes are not levied on the Company. Consequently, income taxes are not reflected in the Company's financial statement. The Company's management does not expect that the total amount of unrecognized tax benefits will materially change over the next twelve months.

### Recent Accounting Pronouncements

In August 2020, the Financial Accounting Standards Board ("FASB") issued Accounting Standards Update ("ASU") 2020-06, Debt — Debt with Conversion and Other Options (Subtopic 470-20) and Derivatives and Hedging — Contracts in Entity's Own Equity (Subtopic 815-40) ("ASU2020-06") to simplify accounting for certain financial instruments. ASU 2020-06 eliminates the current models that require separation of beneficial conversion and cash conversion features from convertible instruments and simplifies the derivative scope exception guidance pertaining to equity classification of contracts in an entity's own equity. The new standard also introduces additional disclosures for convertible debt and freestanding instruments that are indexed to and settled in an entity's own equity. ASU 2020-06 amends the diluted earnings per share guidance, including the requirement to use the if-converted method for all convertible instruments. ASU 2020-06 is effective on January 1, 2024 and should be applied on a full or modified retrospective basis, with early adoption permitted beginning on January 1, 2021. The Company is currently assessing the impact, if any, that ASU 2020-06 would have on its financial position, results of operations or cash flows.

Management does not believe that any other recently issued, but not yet effective, accounting pronouncements, if currently adopted, would have a material effect on the Company's unaudited condensed financial statements.

### Note 3 — Initial Public Offering

On June 11, 2021, the Company consummated its IPO of 20,000,000 Units (the "Units"), at a price of \$10.00 per unit, generating gross proceeds to the Company of \$200,000,000. Each Unit consists of one Class A

ordinary share and one-half of one redeemable warrant. Each whole warrant entitles the holder to purchase one Class A ordinary share at a price of \$11.50 per share, subject to adjustment. The warrants will become exercisable on the later of 30 days after the completion of the initial Business Combination or 12 months from the closing of the IPO, and will expire five years after the completion of the initial Business Combination or earlier upon redemption or liquidation (see Note 8).

#### **Note 4 — Private Placement**

Simultaneously with the closing of the IPO and the sale of the Units, the Company consummated the private placement (the “Private Placement”) of an aggregate 6,000,000 Private Placement Warrants (the “Private Placement Warrants”) at a price of \$1.00 per Private Placement Warrant, for an aggregate purchase price of \$6,000,000. If the Company does not complete an initial Business Combination within the Combination Period, the Private Placement Warrants will expire worthless. The Private Placement Warrants will be non-redeemable by the Company and exercisable on a cashless basis so long as they are held by the Sponsor or its permitted transferees.

If the Private Placement Warrants are held by holders other than the Sponsor or its permitted transferees, the Private Placement Warrants will be redeemable by the Company in all redemption scenarios and exercisable by the holders on the same basis as the warrants included in the units being sold in the IPO.

#### **Note 5 — Related Party Transactions**

##### **Founder Shares**

On December 31, 2020, the Company issued to the Sponsor 5,750,000 Founder Shares for \$25,000 for certain expenses paid on behalf of the Company, or approximately \$0.004 per share. On April 30, 2021, the Company effected a share capitalization, pursuant to which the Company’s initial shareholders held an aggregate of 6,500,000 Class B ordinary shares. The accompanying unaudited condensed financial statements have been retroactively adjusted to reflect the stock dividend in the share capitalization. On April 30, 2021, the Company entered into forward purchase agreements (see Note 6) with anchor investors, in connection with entering into the forward purchase agreements, the Sponsor transferred to the anchor investors an aggregate of 375,000 Class B ordinary shares for no cash. On April 30, 2021, the Sponsor transferred 25,000 Class B ordinary shares each to three independent director nominees. Up to 750,000 Founder Shares were subject to forfeiture by the Sponsor depending on the extent to which the underwriters’ over-allotment option is exercised. On July 23, 2021, the Sponsor surrendered 750,000 Founder Shares, with no return of capital or payment by the Sponsor, after the expiration of the unexercised underwriters’ over-allotment option. As a result of the foregoing, as of September 30, 2022 and December 31, 2021, the Sponsor owned 5,750,000 Class B ordinary shares.

The Sponsor, officers and directors have agreed not to transfer, assign or sell any of their Founder Shares until earliest of (A) one year after the completion of the initial Business Combination and (B) subsequent to the initial Business Combination, (x) if the closing price of the Company’s Class A ordinary shares equals or exceeds \$12.00 per share (as adjusted for share subdivisions, share capitalizations, reorganizations, recapitalizations and the like) for any 20 trading days within any 30-trading day period commencing at least 150 days after the initial Business Combination, or (y) the date on which the Company completes a liquidation, merger, share exchange or other similar transaction that results in all of the Company’s public shareholders having the right to exchange their ordinary shares for cash, securities or other property (the “Lock-up”). Any permitted transferees would be subject to the same restrictions and other agreements of our Sponsor, officers and directors with respect to any Founder Shares.

##### **Promissory Note — Related Party**

The Sponsor has agreed to loan the Company up to \$300,000 to be used for a portion of the expenses of the IPO. These loans were non-interest bearing, unsecured and were due at the earlier of September 30, 2021 or the closing of the IPO. The loan was to be repaid upon completion of the IPO out of the \$1,000,000 of offering proceeds that has been allocated to the payment of offering expenses. The Company had drawn down \$140,068 under the promissory note which was repaid as of June 11, 2021. The note was terminated as of June 11, 2021.

### **Related Party Loans**

In addition, in order to finance transaction costs in connection with an intended initial Business Combination, the Sponsor or an affiliate of the Sponsor, or certain of the Company's officers and directors may, but are not obligated to, loan the Company funds as may be required (the "Working Capital Loans"). If the Company completes the initial Business Combination, the Company may repay the Working Capital Loans out of the proceeds of the Trust Account released to the Company. In the event that the initial Business Combination does not close, the Company may use a portion of the working capital held outside the Trust Account to repay the Working Capital Loans but no proceeds from the Trust Account would be used to repay the Working Capital Loans. Up to \$1,500,000 of such Working Capital Loans may be convertible into warrants at a price of \$1.00 per warrant at the option of the lender. Such warrants would be identical to the Private Placement Warrants.

On September 29, 2022, the Company issued an unsecured, interest-free promissory note to the Sponsor pursuant to which the Company may borrow up to \$1,500,000 from the Sponsor for costs and expenses reasonably related to the Company's working capital needs prior to the consummation of the Business Combination (the "Convertible Promissory Note"). All unpaid principal under the Convertible Promissory Note will become due and payable in full on the date on which the Company consummates the Business Combination, unless earlier accelerated upon the occurrence of an event of default. The Sponsor will have the option, at any time on or prior to the maturity date, to convert any amounts outstanding under the Convertible Promissory Note, up to \$1,500,000 in the aggregate, into warrants to purchase the Company's Class A ordinary shares, at a conversion price of \$1.00 per warrant, with each warrant entitling the holder to purchase one Company's Class A ordinary share at a price of \$11.50 per share, subject to the same adjustments applicable to the private placement warrants sold concurrently with the Company's initial public offering. As of September 30, 2022, there were no outstanding amount under the Convertible Promissory Note. On October 12, 2022, the Company had drawn down \$700,000 under the Convertible Promissory Note. The Convertible Promissory Note will be valued using the fair value method at each reporting period.

### **Administrative Service Fee**

Commencing on the Effective Date, the Company paid an affiliate of the Sponsor \$10,000 per month for office space, utilities, administrative services and remote support services. Upon completion of the initial Business Combination or the Company's liquidation, the Company will cease paying these monthly fees. The Company accrued \$30,000 and \$90,000 for the administrative service fee for the three and nine months ended September 30, 2022, respectively. The Company accrued \$30,000 and \$37,667 for the three months ended September 30, 2021 and for the period from June 8, 2021 (the Effective Date) through September 30, 2021. As of September 30, 2022 and December 31, 2021, there were \$30,000 and \$0 administrative service fee unpaid, which is included in due to related party on the accompanying condensed balance sheets.

### **Note 6 — Recurring Fair Value Measurements**

#### **Warrant Liability and FPA Liability**

As of September 30, 2022 and December 31, 2021, the fair value of Company's Warrant liability was \$2,414,882 and \$10,423,429, respectively, and the fair value of FPA liability was \$3,209,928 and \$2,785,941, respectively. Under the guidance in ASC 815-40, the Public and Private Warrants and the FPA do not meet the criteria for equity treatment. As such, the Public and Private Warrants and the FPA must be recorded on the balance sheet at fair value. This valuation is subject to re-measurement each balance sheet date. With each re-measurement, the valuations will be adjusted to fair value, with the change in fair value recognized in the Company's statement of operations.

#### **Recurring Fair Value Measurements**

The following table presents fair value information as of September 30, 2022 and December 31, 2021 of the Company's financial assets and liabilities that were accounted for at fair value on a recurring basis and indicates the fair value hierarchy of the valuation techniques the Company utilized to determine such fair value. The Company's Warrant liability is based on a valuation models utilizing management judgment and pricing inputs from observable and unobservable markets with less volume and transaction frequency than active markets.

Significant deviations from these estimates and inputs could result in a material change in fair value. The fair values of the Private Warrant liability and FPA liability are classified within Level 3 of the fair value hierarchy. The investments held in Trust Account includes money market funds. The Company uses inputs such as actual trade data, benchmark yields, quoted market prices from dealers or brokers, and other similar sources to determine the fair value of its level 1 investments.

The following table sets forth by level within the fair value hierarchy the Company's assets and liabilities as of September 30, 2022, that were accounted for at fair value on a recurring basis:

	(Level 1)	(Level 2)	(Level 3)
<b>Assets</b>			
Investments held in Trust Account	\$201,200,243	\$ —	\$ —
<b>Liabilities</b>			
Public Warrants	\$ —	\$1,500,000	\$ —
Private Warrants	\$ —	\$ —	\$ 914,882
FPA liability	\$ —	\$ —	\$3,209,928
<b>Total Liabilities</b>	<b>\$ 1,500,000</b>	<b>\$ —</b>	<b>\$4,124,810</b>

The following table sets forth by level within the fair value hierarchy the Company's assets and liabilities as of December 31, 2021, that were accounted for at fair value on a recurring basis:

	(Level 1)	(Level 2)	(Level 3)
<b>Assets</b>			
Investments held in Trust Account	\$200,007,275	\$ —	\$ —
<b>Liabilities</b>			
Public Warrants	\$ 6,500,000	\$ —	\$ —
Private Warrants	\$ —	\$ —	\$3,923,429
FPA liability	\$ —	\$ —	\$2,785,941
<b>Total Liabilities</b>	<b>\$ 6,500,000</b>	<b>\$ —</b>	<b>\$6,709,370</b>

#### Measurement of the Warrants

The Company established the initial fair value for the Warrants on June 11, 2021, the date of the consummation of the Company's IPO. The Company used a Monte Carlo simulation model to value the Warrants. The Company allocated the proceeds received from (i) the sale of Units (which is inclusive of one Class A ordinary share and one-half of one Public Warrant), (ii) the sale of Private Warrants, and (iii) the issuance of Class B ordinary shares, first to the Warrants based on their fair values as determined at initial measurement, with the remaining proceeds allocated to Class A ordinary shares subject to possible redemption (temporary equity), and Class B ordinary shares (permanent equity) based on their relative fair values at the initial measurement date. The estimated fair value of the Public Warrants was transferred from a Level 3 measurement to a Level 1 measurement in August 2021 after detachment of the Public Warrants from the Units and were separately listed and traded. For the period ended September 30, 2022, the Public Warrants were reclassified from Level 1 to Level 2 due to the valuation based on quoted prices (unadjusted) with less volume and transaction frequency than active markets. As of September 30, 2022 and December 31, 2021, the Private Warrants were valued using a Monte Carlo simulation model.

The key inputs for the valuation of Private Warrants are as follows:

<b>Input</b>	<b>September 30, 2022</b>	<b>December 31, 2021</b>
Risk Free Rate	4.04%	1.29%
Stock Price	\$9.82	\$9.72
Est. Term Remaining (Yrs)	5.55	5.35

The following table provides a reconciliation of changes in fair value of the Company's derivative warrant liabilities classified as Level 3 for the nine months ended September 30, 2022 and 2021:

	<b>Public Warrants</b>	<b>Private Warrants</b>	<b>Warrants Liability</b>
Fair value at December 31, 2021	\$ —	\$ 3,923,429	\$ 3,923,429
Change in fair value	—	(2,713,773)	(2,713,773)
Fair Value at March 31, 2022	\$ —	\$ 1,209,656	\$ 1,209,656
Change in fair value	—	(751,093)	(751,093)
Fair Value at June 30, 2022	\$ —	\$ 458,563	\$ 458,563
Change in fair value	—	456,319	456,319
Fair Value at September 30, 2022	<u>\$ —</u>	<u>\$ 914,882</u>	<u>\$ 914,882</u>

	<b>Public Warrants</b>	<b>Private Warrants</b>	<b>Warrants Liability</b>
Fair value at December 31, 2020	\$ —	\$ —	\$ —
Initial value of warrant liabilities at IPO (June 11, 2021)	8,511,409	5,201,555	13,712,964
Change in fair value	1,212,798	672,323	1,885,121
Fair value at June 30, 2021	\$ 9,724,207	\$ 5,873,878	\$ 15,598,085
Change in fair value	(1,123,207)	(673,904)	(1,797,111)
Transfer of Public warrants from Level 3 to Level 1	(8,601,000)	—	(8,601,000)
Fair Value at September 30, 2021	<u>\$ —</u>	<u>\$ 5,199,974</u>	<u>\$ 5,199,974</u>

#### FPA

To arrive at the conclusion of Fair Value of the Forward Purchase Agreements, the Company analyzed the agreements and other documentation. The Company utilized the underlying shares and warrant values determined above and the following inputs in order to project the net asset or liability value of the FPA:

<b>Input</b>	<b>September 30, 2022</b>	<b>December 31, 2021</b>
Stock Price	\$ 9.82	\$ 9.72
Warrant Price	\$0.150	\$ 0.65
Est. Term to Business Combination (Yrs)	0.55	0.33
Probability of Business Combination	85%	85%
Purchase price of FPA unit	\$10.00	\$10.00
Discount rate	3.93%	0.04%

The following table provides a reconciliation of changes in fair value of the Company's FPA liability classified as Level 3 for the nine months ended September 30, 2022 and 2021:

	<u>FPA liability</u>
Fair value at December 31, 2021	\$2,785,941
Change in fair value	(127,629)
Fair Value at March 31, 2022	\$2,658,312
Change in fair value	141,728
Fair Value at June 30, 2022	\$2,800,040
Change in fair value	409,888
Fair Value at September 30, 2022	<u>\$3,209,928</u>
	<u>FPA Liability</u>
Fair value at December 31, 2020	\$ —
Initial value of FPA liability at IPO (June 11, 2021)	2,322,741
Change in fair value	(77,703)
Fair value at June 30, 2021	\$2,245,038
Change in fair value	561,983
Fair value at September 30, 2021	<u>\$2,807,021</u>

Transfers between levels of the fair value hierarchy are recognized at the end of the reporting period. There are no transfers to or from Level 3 for the three and nine months ended September 30, 2022.

#### **Note 7— Commitments & Contingencies**

##### **Risks and Uncertainties**

Management continues to evaluate the impact of the COVID-19 pandemic on the industry and has concluded that while it is reasonably possible that the virus could have a negative effect on the Company's financial position, results of its operations and/or search for a target company, the specific impact is not readily determinable as of the date of this financial statement. The financial statement does not include any adjustments that might result from the outcome of this uncertainty.

##### **Registration Rights**

The holders of the Founder Shares, Private Placement Warrants and any warrants that may be issued upon conversion of Working Capital Loans (and any Class A ordinary shares issuable upon the exercise of the Private Placement Warrants and warrants that may be issued upon conversion of Working Capital Loans) will be entitled to registration rights pursuant to a registration and shareholder rights agreement to be signed prior to or on the effective date of the IPO. The holders of these securities are entitled to make up to three demands, excluding short form demands, that the Company registers such securities. In addition, the holders have certain "piggy-back" registration rights with respect to registration statements filed subsequent to the Company's completion of its initial Business Combination. However, the registration and shareholder rights agreement provides that the Company will not permit any registration statement filed under the Securities Act to become effective until termination of the applicable Lock-up period, which occurs (i) in the case of the Founder Shares, and (ii) in the case of the Private Placement Warrants and the respective Class A ordinary shares underlying such warrants, 30 days after the completion of the initial Business Combination. The Company will bear the expenses incurred in connection with the filing of any such registration statements.

##### **Underwriters Agreement**

The underwriters had a 45-day option to purchase up to an additional 3,000,000 units to cover over-allotments, if any. The over-allotment option expired unexercised on July 23, 2021.

The underwriters were paid a cash underwriting discount of two percent (2%) of the gross proceeds of the IPO, or \$4,000,000. Additionally, the underwriters are entitled to a deferred underwriting discount of 3.5% of the gross proceeds of the IPO upon the completion of the Company's initial Business Combination. On July 7, 2022, a waiver letter was signed by the Company and BofA Securities, Inc. ("BofA"), pursuant to which BofA announced it waived its entitlement to the payment of any deferred underwriting discount to be paid under the terms of the underwriting agreement. The Company recognized \$7,000,000 gain recognized on extinguishment of deferred underwriting commissions in the operations in connection with such waiver.

#### **Forward Purchase Agreements**

On April 30, 2021, the Company entered into forward purchase agreements with the Sponsor, Snow Lake Capital (HK) Limited and Valliance Fund (the "anchor investors"), pursuant to which the anchor investors agreed to subscribe for an aggregate of 3,000,000 Class A ordinary shares plus 750,000 redeemable warrants for a purchase price of \$10.00 multiplied by the number of Class A ordinary shares, or \$30,000,000 in the aggregate, in a private placement to close concurrently with the closing of the initial business combination. The Company issued 750,000 additional Class B ordinary shares to the Sponsor, which represent the adjustment to the ratio applicable to the conversion of the Class B ordinary shares that the Sponsor would have been entitled to at the closing of the initial business combination as a result of the issuance of 3,000,000 additional Class A ordinary shares under the forward purchase agreements. As a result, the issuance of the Class A ordinary shares at the closing of the initial business combination will not trigger a further adjustment to this ratio. Further, prior to the IPO, the Sponsor transferred to the anchor investors an aggregate of 375,000 Founder Shares for no cash consideration. Subject to certain exceptions to forfeiture and transfer provisions, the Founder Shares transferred in connection with these agreements are subject to similar contractual conditions and restrictions as the Founder Shares issued to the Sponsor in connection with the IPO. The forward purchase warrants will have the same terms as the public warrants.

The forward purchase agreements provide that the anchor investors are entitled to registration rights with respect to the forward purchase securities and Class A ordinary shares underlying the forward purchase warrants and Founder Shares.

The proceeds from the sale of the forward purchase securities may be used as part of the consideration to the sellers in the initial Business Combination, expenses in connection with the initial Business Combination or for working capital in the post Business Combination company. These purchases will be required to be made regardless of whether any Class A ordinary shares are redeemed by the public shareholders and are intended to provide the Company with a minimum funding level for the initial Business Combination. The anchor investors will not have the ability to approve the initial Business Combination prior to the signing of a material definitive agreement and, if the Company seeks shareholder approval, have agreed to vote their Founder Shares and any public shares held by them in favor of the initial Business Combination. The forward purchase securities will be issued only in connection with the closing of the initial Business Combination.

#### **Business Combination Agreement**

On September 29, 2022, the Company entered into a Business Combination Agreement with YishengBio Co., Ltd., an exempted company limited by shares incorporated under the laws of the Cayman Islands (to be renamed as YS Biopharma Co., Ltd, herein referred to as "YS Biopharma"), Oceanview Bioscience Acquisition Co., Ltd., an exempted company limited by shares incorporated under the laws of the Cayman Islands and a direct wholly-owned subsidiary of YS Biopharma ("Merger Sub I") and Hudson Biomedical Group Co., Ltd., an exempted company limited by shares incorporated under the laws of the Cayman Islands and a direct wholly-owned subsidiary of YS Biopharma ("Merger Sub II," and together with Merger Sub I, "Merger Subs"). Capitalized terms in this Item 1.01 not otherwise defined shall have the meanings ascribed to them in the Business Combination Agreement.

The Business Combination Agreement provides for (i) the merger of Merger Sub I with and into Summit (the "First Merger"), with Summit surviving the First Merger as the surviving entity (the "Surviving Entity") and becoming a wholly-owned subsidiary of YS Biopharma, and (ii) the merger of the Surviving Entity with and into Merger Sub II (the "Second Merger," and together with the First Merger, the "Mergers," together with other transactions contemplated by the Business Combination Agreement, the "Transactions"), with Merger

Sub II surviving the Second Merger as the surviving company (the “Surviving Company”) and remaining as the wholly-owned subsidiary of YS Biopharma.

Subject to, and in accordance with the terms and conditions set forth in the Business Combination Agreement, immediately prior to the effective time of the First Merger (the “First Merger Effective Time”), (i) each preferred share of YS Biopharma with par value of US\$0.000005 will be converted into one ordinary share of YS Biopharma with par value of US\$0.000005; (ii) after the conversion of all preferred shares into ordinary shares, each four of the ordinary shares of YS Biopharma with par value of US\$0.000005 will be consolidated into one ordinary share of YS Biopharma with par value of US\$0.00002, and each four of the options to acquire ordinary shares of YS Biopharma will be consolidated into one option to acquire ordinary share of YS Biopharma, subject to rounding up to the nearest whole number of shares; and (iii) the second amended and restated memorandum and articles of association of YS Biopharma shall be adopted and become effective. Items (i) through (iii) are herein referred to as the “YS Biopharma Capital Restructuring.”

Concurrently with the execution of the Business Combination Agreement, YS Biopharma and Summit entered into a Shareholder Support Agreement and Deed with certain YS Biopharma shareholders and certain Summit shareholders with respect to the Transactions and post-Closing rights and obligations of shareholders of YS Biopharma.

#### **Note 8—Warrant Liability**

As of September 30, 2022 and December 31, 2021, 16,000,000 warrants (the 10,000,000 Public Warrants and the 6,000,000 Private Placement Warrants) are outstanding. Each warrant entitles the holder to purchase one Class A ordinary share at a price of \$11.50 per share, subject to adjustment as discussed herein. The warrants will become exercisable on the later of 12 months from the closing of the IPO or 30 days after the completion of its initial Business Combination, and will expire five years after the completion of the Company’s initial Business Combination or earlier upon redemption or liquidation

##### *Redemption of warrants when the price per Class A ordinary share equals or exceeds \$18.00.*

Once the warrants become exercisable, the Company may redeem the outstanding warrants (except as described herein with respect to the Private Placement Warrants):

- in whole and not in part;
- at a price of \$0.01 per warrant;
- upon a minimum of 30 days’ prior written notice of redemption to each warrant holder; and
- if, and only if, the closing price of the Class A ordinary shares equals or exceeds \$18.00 per share (as adjusted for adjustments to the number of shares issuable upon exercise or the exercise price of a warrant) for any 20 trading days with in a 30-trading day period ending three trading days before the Company sends the notice of redemption to the warrant holders.

If and when the warrants become redeemable by the Company, the Company may exercise its redemption right even if it is unable to register or qualify the underlying securities for sale under all applicable state securities laws.

##### *Redemption of warrants when the price per Class A ordinary share equals or exceeds \$10.00*

Once the warrants become exercisable, the Company may redeem the outstanding warrants:

- in whole and not in part;
- at \$0.10 per warrant upon a minimum of 30 days’ prior written notice of redemption provided that holders will be able to exercise their warrants on a cashless basis prior to redemption and receive that number of shares determined by reference to the table below, based on the redemption date and the “fair market value” of the Class A ordinary shares;



- if, and only if, the closing price of our Class A ordinary shares equals or exceeds \$10.00 per public share (as adjusted for adjustments to the number of shares issuable upon exercise or the exercise price of a warrant) for any 20 trading days with in the 30-trading day period ending three trading days before the Company sends the notice of redemption to the warrant holders; and
- if the closing price of the Class A ordinary shares for any 20 trading days with in a 30-trading day period ending on the third trading day prior to the date on which the Company sends the notice of redemption to the warrant holders is less than \$18.00 per share (as adjusted for adjustments to the number of shares issuable upon exercise or the exercise price of a warrant), the Private Placement Warrants must also be concurrently called for redemption on the same terms as the outstanding public warrants, as described above.

In addition, if (x) the Company issues additional Class A ordinary shares or equity-linked securities for capital raising purposes in connection with the closing of the initial Business Combination at an issue price or effective issue price of less than \$9.20 per ordinary share (with such issue price or effective issue price to be determined in good faith by the Company's board of directors and in the case of any such issuance to the Company's Sponsors or its affiliate, without taking into account any Founder Shares held by the Company's Sponsor or such affiliates, as applicable, prior to such issuance (the "Newly Issued Price"), (y) the aggregate gross proceeds from such issuances represent more than 60% of the total equity proceeds, and interest thereon, available for the funding of the initial Business Combination on the date of the completion of the initial Business Combination (net of redemptions), and (z) the volume weighted average trading price of the Company's Class A ordinary shares during the 20 trading day period starting on the trading day prior to the day on which the Company consummates its initial Business Combination (such price, the "Market Value") is below \$9.20 per share, the exercise price of the warrants will be adjusted (to the nearest cent) to be equal to 115% of the higher of the Market Value and the Newly Issued Price, and the \$18.00 per share redemption trigger price described above will be adjusted (to the nearest cent) to be equal to 180% of the higher of the Market Value and the Newly Issued Price, and the \$10.00 per share redemption trigger price described above will be adjusted (to the nearest cent) to be equal to the higher of the Market Value and the Newly Issued Price.

#### **Note 9 — Shareholders' Deficit**

##### **Preference shares**

The Company is authorized to issue 5,000,000 preference shares with a par value of \$0.0001 and with such designations, voting and other rights and preferences as may be determined from time to time by the Company's board of directors. As of September 30, 2022 and December 31, 2021, there were no preference shares issued or outstanding.

##### **Class A Ordinary Shares**

The Company is authorized to issue 500,000,000 Class A ordinary shares with a par value of \$0.0001 per share. As of September 30, 2022 and December 31, 2021, there were 20,000,000 Class A ordinary shares issued and outstanding, including the 20,000,000 shares presented in ordinary shares subject to redemption.

##### **Class B Ordinary Shares**

The Company is authorized to issue 50,000,000 Class B ordinary shares with a par value of \$0.0001 per share. Holders are entitled to one vote for each share of Class B ordinary shares. As of September 30, 2022 and December 31, 2021, there were 5,750,000 Class B ordinary shares issued and outstanding. Of the 6,500,000 Class B ordinary shares, an aggregate of up to 750,000 shares were subject to forfeiture to the Company for no consideration to the extent that the underwriters' over-allotment option was not exercised in full or in part, so that the initial shareholders will collectively own 20% of the Company's issued and outstanding ordinary shares after the IPO. On July 23, 2021, the Sponsor surrendered 750,000 Founder Shares, with no return of capital or payment by the Sponsor, after the expiration of the unexercised underwriters' over-allotment option.

Class A ordinary shareholders and Class B ordinary shareholders of record are entitled to one vote for each share held on all matters to be voted on by shareholders and vote together as a single class, except as required by law. Prior to the initial Business Combination, only holders of the Founder Shares will have the right to

vote on the election of directors. Holders of the public shares will not be entitled to vote on the appointment of directors during such time. In addition, prior to the completion of an initial Business Combination, holders of a majority of the Founder Shares may remove a member of the board of directors for any reason.

The Class B ordinary shares will automatically convert into Class A ordinary shares (which such Class A ordinary shares delivered upon conversion will not have redemption rights or be entitled to liquidating distributions from the Trust Account if the Company does not consummate an initial Business Combination) at the time of the initial Business Combination or earlier at the option of the holders thereof at a ratio such that the number of Class A ordinary shares issuable upon conversion of all Founder Shares will equal, in the aggregate, on an as-converted basis, 20% of the sum of (i) the total number of ordinary shares issued and outstanding upon the completion of the IPO, plus (ii) the total number of Class A ordinary shares issued or deemed issued or issuable upon conversion or exercise of any equity-linked securities or rights issued or deemed issued, by the Company in connection with or in relation to the consummation of the initial Business Combination, excluding any Class A ordinary shares or equity-linked securities exercisable for or convertible into Class A ordinary shares issued, deemed issued or to be issued to any seller in the initial Business Combination and any Private Placement Warrants issued to the Sponsor, its affiliates or any member of our management team upon conversion of Working Capital Loans. In no event will the Class B ordinary shares convert into Class A ordinary shares at a rate of less than one-to-one.

**Note 10— Subsequent Events**

The Company evaluated subsequent events and transactions that occurred after the balance sheet date up to the date that the unaudited condensed financial statements were issued. Based on this review, other than the events described below, the Company did not identify any subsequent events that would have required adjustment or disclosure in the financial statements.

On October 12, 2022, the Company had drawn down \$700,000 under the Convertible Promissory Note. The Convertible Promissory Note will be valued using the fair value method at each reporting period.

**REPORT OF INDEPENDENT REGISTERED PUBLIC ACCOUNTING FIRM**

To the Stockholders and the Board of Directors of  
Summit Healthcare Acquisition Corp.

**Opinion on the Financial Statements**

We have audited the accompanying balance sheets of Summit Healthcare Acquisition Corp. (the “Company”) as of December 31, 2021 and 2020, the related statements of operations, changes in shareholders’ (deficit) equity and cash flows for the year ended December 31, 2021 and the period from December 22, 2020 (inception) through December 31, 2020 and the related notes (collectively referred to as the “financial statements”). In our opinion, the financial statements present fairly, in all material respects, the financial position of the Company as of December 31, 2021 and 2020, and the results of its operations and its cash flows for the year ended December 31, 2021 and the period from December 22, 2020 (inception) through December 31, 2020, in conformity with accounting principles generally accepted in the United States of America.

**Basis for Opinion**

These financial statements are the responsibility of the Company’s management. Our responsibility is to express an opinion on the Company’s financial statements based on our audits. We are a public accounting firm registered with the Public Company Accounting Oversight Board (United States) (“PCAOB”) and are required to be independent with respect to the Company in accordance with the U.S. federal securities laws and the applicable rules and regulations of the Securities and Exchange Commission and the PCAOB.

We conducted our audits in accordance with the standards of the PCAOB. Those standards require that we plan and perform the audits to obtain reasonable assurance about whether the financial statements are free of material misstatement, whether due to error or fraud. The Company is not required to have, nor were we engaged to perform, an audit of its internal control over financial reporting. As part of our audits we are required to obtain an understanding of internal control over financial reporting but not for the purpose of expressing an opinion on the effectiveness of the Company’s internal control over financial reporting. Accordingly, we express no such opinion.

Our audits included performing procedures to assess the risks of material misstatement of the financial statements, whether due to error or fraud, and performing procedures that respond to those risks. Such procedures included examining, on a test basis, evidence regarding the amounts and disclosures in the financial statements. Our audits also included evaluating the accounting principles used and significant estimates made by management, as well as evaluating the overall presentation of the financial statements. We believe that our audits provide a reasonable basis for our opinion.

/s/ WithumSmith+Brown, PC

We have served as the Company’s auditor since 2020.

New York, New York  
March 31, 2022

## SUMMIT HEALTHCARE ACQUISITION CORP.

## BALANCE SHEETS

	December 31, 2021	December 31, 2020
<b>Assets</b>		
Current assets:		
Cash	\$ 885,198	\$ —
Prepaid expenses	141,677	—
<b>Total current assets</b>	<b>1,026,875</b>	<b>—</b>
Deferred offering costs	—	91,374
Investments held in Trust Account	200,007,275	—
<b>Total Assets</b>	<b>\$201,034,150</b>	<b>\$91,374</b>
<b>Liabilities, Class A Ordinary Shares Subject to Possible Redemption and Shareholders' (Deficit) Equity</b>		
Current liabilities:		
Accrued offering costs and expenses	\$ 142,631	\$65,000
Note payable – related party	—	5,010
<b>Total current liabilities</b>	<b>142,631</b>	<b>70,010</b>
FPA liability	2,785,941	—
Warrant liability	10,423,429	—
Deferred underwriting commissions	7,000,000	—
<b>Total Liabilities</b>	<b>20,352,001</b>	<b>70,010</b>
<b>Commitments and Contingencies (Note 7)</b>		
Class A ordinary shares subject to possible redemption, \$0.0001 par value; 20,000,000 shares and 0-shares issued and outstanding at redemption value of \$10.00 per share	200,000,000	—
<b>Shareholders' (Deficit) Equity:</b>		
Preference shares, \$0.0001 par value; 5,000,000 shares authorized; none issued or outstanding	—	—
Class A ordinary shares, \$0.0001 par value; 500,000,000 shares authorized;	—	—
Class B ordinary shares, \$0.0001 par value; 50,000,000 shares authorized; 5,750,000 and 6,500,000 shares issued and outstanding at December 31, 2021 and 2020, respectively	575	650 <sup>(1)</sup>
Additional paid-in capital	—	24,350
Accumulated deficit	(19,318,426)	(3,636)
<b>Total shareholders' (Deficit) Equity</b>	<b>(19,317,851)</b>	<b>21,364</b>
<b>Total Liabilities, Class A Ordinary Shares Subject to Possible Redemption and Shareholders' (Deficit) Equity</b>	<b>\$201,034,150</b>	<b>\$91,374</b>

(1) This number includes up to 750,000 Class B ordinary shares subject to forfeiture as of December 31, 2020. On July 23, 2021, the 750,000 Class B ordinary shares were forfeited when the over-allotment option expired.

The accompanying notes are an integral part of these financial statements.

**SUMMIT HEALTHCARE ACQUISITION CORP.**  
**STATEMENTS OF OPERATIONS**

	Year Ended December 31, 2021	For the period from December 22, 2020 (Inception) through December 31, 2020
General and administrative expenses	\$ 549,179	\$ 3,636
<b>Loss from operations</b>	<b>(549,179)</b>	<b>(3,636)</b>
<b>Other income (expense):</b>		
Change in fair value of FPA	(2,785,941)	—
Change in fair value of warrant liability	3,289,535	—
Transaction costs allocable to warrants	(507,417)	—
Interest earned on investments held in Trust Account	7,275	—
<b>Other income (loss)</b>	<b>3,452</b>	<b>—</b>
<b>Net Loss</b>	<b>\$ (545,727)</b>	<b>\$ (3,636)</b>
<b>Basic and diluted weighted average shares outstanding, Class A ordinary shares subject to possible redemption</b>	<b>11,178,082</b>	<b>—</b>
<b>Basic and diluted net loss per ordinary share, Class A ordinary shares subject to possible redemption</b>	<b>\$ (0.03)</b>	<b>\$ —</b>
<b>Basic and diluted weighted average shares outstanding, Class B ordinary shares</b>	<b>5,750,000</b>	<b>5,750,000</b>
<b>Basic and diluted net loss per share, Class B ordinary shares</b>	<b>\$ (0.03)</b>	<b>\$ (0.00)</b>

The accompanying notes are an integral part of these financial statements.

**SUMMIT HEALTHCARE ACQUISITION CORP.**  
**STATEMENTS OF CHANGES IN SHAREHOLDERS' (DEFICIT) EQUITY**  
**FOR THE PERIOD FROM DECEMBER 22, 2020 (INCEPTION) THROUGH DECEMBER 31, 2021**

	Class A Ordinary Shares		Class B Ordinary Shares		Additional Paid-in Capital	Accumulated Deficit	Total Shareholders' (Deficit) Equity
	Shares	Amount	Shares	Amount			
<b>Balance as of December 22, 2020 (Inception)</b>	—	\$ —	—	\$ —	\$ —	\$ —	\$ —
Class B ordinary shares issued to initial shareholders	—	—	6,500,000	\$650	\$ 24,350	\$ —	\$ 25,000
Net loss	—	—	—	—	—	(3,636)	(3,636)
<b>Balance as of December 31, 2020</b>	—	\$ —	<b>6,500,000</b>	<b>\$650</b>	<b>\$ 24,350</b>	<b>\$ (3,636)</b>	<b>\$ 21,364</b>
Excess of private placement proceeds over fair value as capital contribution	—	—	—	—	798,445	—	798,445
Accretion of Class A ordinary shares to redemption value	—	—	—	—	(822,795)	(18,769,138)	(19,591,933)
Forfeiture of founder shares	—	—	(750,000)	(75)	—	75	—
Net loss	—	—	—	—	—	(545,727)	(545,727)
<b>Balance as of December 31, 2021</b>	—	\$ —	<b>5,750,000</b>	<b>\$575</b>	<b>\$ —</b>	<b>\$(19,318,426)</b>	<b>\$(19,317,851)</b>

The accompanying notes are an integral part of these financial statements.

**SUMMIT HEALTHCARE ACQUISITION CORP.**  
**STATEMENTS OF CASH FLOWS**

	Year Ended December 31, 2021	For the period from December 22, 2020 (Inception) through December 31, 2020
<b>Cash Flows from Operating Activities:</b>		
Net loss	\$ (545,727)	\$ (3,636)
Adjustments to reconcile net loss to net cash provided by operating activities:		
Interest earned on investments held in Trust Account	(7,275)	3,636
Change in fair value of FPA liability	2,785,941	—
Change in fair value of warrant liability	(3,289,535)	—
Transaction costs allocable to warrants	507,417	—
Changes in operating assets and liabilities:		
Prepaid expenses	(141,677)	—
Accrued offering costs and expenses	77,631	—
<b>Net cash used in operating activities</b>	<b>(613,225)</b>	<b>—</b>
<b>Cash Flows from Investing Activities</b>		
Investment of cash in Trust Account	(200,000,000)	—
<b>Net cash used in investing activities</b>	<b>(200,000,000)</b>	<b>—</b>
<b>Cash Flows from Financing Activities:</b>		
Proceeds received from initial public offering, net of underwriters' discount	196,000,000	—
Proceeds from private placement	6,000,000	—
Payment of offering costs	(140,554)	—
Repayment of note payable from related party	(361,023)	—
<b>Net cash provided by financing activities</b>	<b>201,498,423</b>	<b>—</b>
<b>Net change in cash</b>	<b>885,198</b>	<b>—</b>
<b>Cash, beginning of the period</b>	<b>—</b>	<b>—</b>
<b>Cash, end of the period</b>	<b>\$ 885,198</b>	<b>\$ —</b>
<b>Supplemental Non-cash disclosure of cash flow information:</b>		
Deferred offering costs paid by Sponsor under promissory note	\$ 135,544	\$ 1,374
Deferred offering costs paid by Sponsor in exchange for issuance of Class B ordinary shares	\$ —	\$25,000
Deferred underwriting discount	\$ 7,000,000	\$ —
Accrued deferred offering costs	\$ —	\$65,000

The accompanying notes are an integral part of these financial statements.

**SUMMIT HEALTHCARE ACQUISITION CORP.****NOTES TO FINANCIAL STATEMENTS****Note 1 — Organization, Business Operation, Liquidity and Capital Resources**

Summit Healthcare Acquisition Corp. (the “Company”) is a blank check company incorporated on December 22, 2020 as a Cayman Islands exempted company. The Company was incorporated for the purpose of effecting a merger, share exchange, asset acquisition, share purchase, reorganization or similar business combination with one or more businesses (the “Business Combination”). The Company has not selected any specific Business Combination target under consideration or contemplation and the Company has not, nor has anyone on its behalf, contacted any prospective target business or had any discussions, formal or otherwise, with respect to such a transaction. The Company’s efforts to identify a prospective target business will not be limited to a particular geographic region or industry, although it intends to focus on healthcare.

As of December 31, 2021, the Company had not commenced any operations. All activity for the period from December 22, 2020 (inception) through December 31, 2021 relates to the Company’s formation and the initial public offering (the “IPO”). The Company will not generate any operating revenues until after the completion of its initial Business Combination, at the earliest. The Company will generate non-operating income in the form of interest income on cash and cash equivalents from the proceeds derived from the IPO. The Company has selected December 31 as its fiscal year end.

The Company’s Sponsor is Summit Healthcare Acquisition Sponsor LLC, a Cayman Islands limited liability company (the “Sponsor”). The registration statement for the Company’s IPO was declared effective on June 8, 2021 (the “Effective Date”). On June 11, 2021, the Company consummated the IPO of 20,000,000 units (the “Units” and, with respect to the Class A ordinary shares included in the Units being offered, the “Public Shares”) 10.00 per Unit, generating gross proceeds of \$200,000,000, which is discussed in Note 3.

Simultaneously with the consummation of the IPO and the issuance and sale of the Units, the Company consummated the private placement of 6,000,000 Private Placement Warrants (the “Private Placement Warrants”) at a price of \$1.00 per Private Placement Warrant, to the Sponsor, generating total proceeds of \$6,000,000. Transaction costs amounted to \$11,587,941 consisting of \$4,000,000 of underwriting commissions, \$7,000,000 of deferred underwriting commissions and \$587,941 of other cash offering costs. In addition, \$1,827,347 of cash was held in the Trust Account (as defined below) temporarily and is available for working capital purposes.

Following the closing of the IPO on June 11, 2021, \$200,000,000 (\$10.00 per Unit) from the net proceeds of the sale of the Units in the IPO and the sale of the Private Placement Warrants was placed in a Trust Account and, will be held in a U.S.-based trust account (“Trust Account”) with Continental Stock Transfer & Trust Company acting as trustee, and will be invested only in U.S. government treasury bills with a maturity of 185 days or less or in money market funds investing solely in U.S. Treasuries and meeting certain conditions under Rule 2a-7 under the Investment Company Act.

Except with respect to interest earned on the funds held in the Trust Account that may be released to the Company to pay its income taxes, if any, the Company’s amended and restated memorandum and articles of association and subject to the requirements of law and regulation, will provide that the proceeds from the IPO and the sale of the Private Placement Warrants held in the Trust Account will not be released from the Trust Account (1) to the Company, until the completion of the initial Business Combination, or (2) to the Company’s public shareholders until the earliest of: (i) the completion of an initial Business Combination, and then only in connection with those Class A ordinary shares that such shareholders properly elected to redeem, (ii) the redemption of any public shares properly tendered in connection with a shareholder vote to amend the Company’s amended and restated memorandum and articles of association, and (iii) the redemption of the Company’s public shares if the Company has not consummated its Business Combination within 24 months from the closing of the IPO, subject to applicable law.

The ordinary shares subject to redemption are recorded at a \$10 redemption value and classified as temporary equity in accordance with Accounting Standards Codification (“ASC”) Topic 480 “Distinguishing Liabilities from Equity.”



The Company will have 24 months from the closing of the IPO to complete the initial Business Combination (the "Combination Period") or during any Extension Period. However, if the Company is unable to complete the initial Business Combination within the Combination Period, the Company will (i) cease all operations except for the purpose of winding up, (ii) as promptly as reasonably possible but not more than ten business days thereafter, redeem the public shares, at a per-share price, payable in cash, equal to the aggregate amount then on deposit in the Trust Account, including interest earned on the funds held in the Trust Account and not previously released to the Company to pay its income taxes, if any (less up to \$100,000 of interest to pay dissolution expenses), divided by the number of the then outstanding public shares, which redemption will completely extinguish public shareholders' rights as shareholders (including the right to receive further liquidation distributions, if any), and (iii) as promptly as reasonably possible following such redemption, subject to the approval of the Company's remaining shareholders and the Company's board of directors, liquidate and dissolve, subject in each case to the Company's obligations under Cayman Islands law to provide for claims of creditors and the requirements of other applicable law.

The Sponsor and the Company's officers and directors agreed to (i) waive their redemption rights with respect to their Founder Shares in connection with the completion of the initial Business Combination, (ii) waive their redemption rights with respect to their Founder Shares and public shares in connection with a shareholder vote to approve an amendment to the Company's amended and restated memorandum and articles of association, (iii) waive their rights to liquidating distributions from the Trust Account with respect to any Founder Shares they hold if the Company fails to complete the initial Business Combination within the Combination Period or during any Extension Period (although they will be entitled to liquidating distributions from the Trust Account with respect to any public shares they hold if the Company fails to complete its initial Business Combination within the prescribed timeframe), and (iv) vote any Founder Shares and public shares held by them in favor of the initial Business Combination.

The Sponsor has agreed that it will be liable to the Company if and to the extent any claims by a third party (other than the Company's independent registered public accounting firm) for services rendered or products sold to the Company, or a prospective target business with which the Company has discussed entering into a transaction agreement, reduce the amounts in the Trust Account to below the lesser of (i) \$10.00 per public share or (ii) the actual amount per public share held in the Trust Account as of the date of the liquidation of the Trust Account if less than \$10.00 per public share due to reductions in the value of the trust assets, in each case net of the interest that may be withdrawn to pay the Company's tax obligations, provided that such liability will not apply to any claims by a third party or prospective target business that executed a waiver of any and all rights to seek access to the Trust Account nor will it apply to any claims under the Company's indemnity of the underwriter of the IPO against certain liabilities, including liabilities under the Securities Act. However, the Company has not asked its Sponsor to reserve for such indemnification obligations, nor has the Company independently verified whether its Sponsor has sufficient funds to satisfy its indemnity obligations and the Company believes that the Sponsor's only assets are securities of the Company. Therefore, the Company cannot assure you that the Sponsor would be able to satisfy those obligations. None of the Company's officers or directors will indemnify the Company for claims by third parties including, without limitation, claims by vendors and prospective target businesses.

#### **Liquidity and Capital Resources**

As of December 31, 2021, the Company had approximately \$0.89 million of cash for working capital purposes, and working capital of approximately \$0.88 million.

The Company's liquidity needs up to December 31, 2021 had been satisfied through a payment from the Sponsor of \$25,000 (see Note 5) for the Founder Shares to cover certain offering costs and the loan under an unsecured promissory note from the Sponsor of \$300,000 (see Note 5).

The promissory note was fully repaid on June 11, 2021. In addition, in order to finance transaction costs in connection with a Business Combination, the Company's Sponsor or an affiliate of the Sponsor or certain of the Company's officers and directors may, but are not obligated to, provide the Company Working Capital Loans, as defined below (see Note 5). As of December 31, 2021, there were no amounts outstanding under any Working Capital Loans.

Based on the foregoing, management believes that the Company will have sufficient working capital and borrowing capacity to meet its needs through the earlier of the consummation of a Business Combination or one year from this filing. Over this time period, the Company will be using these funds for paying existing accounts payable, identifying and evaluating prospective initial Business Combination candidates, performing due diligence on prospective target businesses, paying for travel expenditures, selecting the target business to merge with or acquire, and structuring, negotiating and consummating the Business Combination.

## **Note 2 — Significant Accounting Policies**

### **Basis of Presentation**

The accompanying financial statements of the Company are presented in conformity with accounting principles generally accepted in the United States of America (“US GAAP”) and pursuant to the rules and regulations of the Security and Exchange Commission (“SEC”). In the opinion of management, all adjustments (consisting of normal recurring adjustments) have been made that are necessary to present fairly the financial position, and the results of its operations and its cash flows.

### **Emerging Growth Company Status**

The Company is an “emerging growth company,” as defined in Section 2(a) of the Securities Act of 1933, as amended, (the “Securities Act”), as modified by the Jumpstart our Business Startups Act of 2012, (the “JOBS Act”), and it may take advantage of certain exemptions from various reporting requirements that are applicable to other public companies that are not emerging growth companies including, but not limited to, not being required to comply with the auditor attestation requirements of Section 404 of the Sarbanes-Oxley Act, reduced disclosure obligations regarding executive compensation in its periodic reports and proxy statements, and exemptions from the requirements of holding a nonbinding advisory vote on executive compensation and shareholder approval of any golden parachute payments not previously approved.

Further, Section 102(b)(1) of the JOBS Act exempts emerging growth companies from being required to comply with new or revised financial accounting standards until private companies (that is, those that have not had a Securities Act registration statement declared effective or do not have a class of securities registered under the Exchange Act) are required to comply with the new or revised financial accounting standards. The JOBS Act provides that a company can elect to opt out of the extended transition period and comply with the requirements that apply to non-emerging growth companies but any such election to opt out is irrevocable. The Company has elected not to opt out of such extended transition period which means that when a standard is issued or revised and it has different application dates for public or private companies, the Company, as an emerging growth company, can adopt the new or revised standard at the time private companies adopt the new or revised standard. This may make comparison of the Company’s financial statements with another public company which is neither an emerging growth company nor an emerging growth company which has opted out of using the extended transition period difficult or impossible because of the potential differences in accounting standards used.

### **Use of Estimates**

The preparation of the financial statements in conformity with US GAAP requires management to make estimates and assumptions that affect the reported amounts of assets and liabilities and disclosure of contingent assets and liabilities at the date of the financial statements and the reported amounts of expenses during the reporting period.

Making estimates requires management to exercise significant judgement. It is at least reasonably possible that the estimate of the effect of a condition, situation or set of circumstances that existed at the date of the financial statement, which management considered in formulating its estimate, could change in the near term due to one or more future confirming events. One of the more significant estimates included in these financial statements is the determination of the fair value of the warrant liability and Forward Purchase Agreement (“FPA”) liability.

**Cash and Cash Equivalents**

The Company considers all short-term investments with an original maturity of three months or less when purchased to be cash equivalents. The Company did not have cash equivalents as of December 31, 2021 and December 31, 2020.

**Investments Held in Trust Account**

As of December 31, 2021, the assets held in the Trust Account were held in a money market fund. The Company's portfolio of investments held in the Trust Account is comprised of U.S. government securities, within the meaning set forth in Section 2(a)(16) of the Investment Company Act, with a maturity of 185 days or less, investments in money market funds that invest in U.S. government securities, cash, or a combination thereof. The Company's investments held in the Trust Account are classified as trading securities. Trading securities are presented on the balance sheets at fair value at the end of each reporting period. Gains and losses resulting from the change in fair value of these securities is included in gain on Investments Held in Trust Account in the accompanying statement of operations. The estimated fair values of investments held in the Trust Account are determined using available market information. At December 31, 2021 and 2020, the Company had \$200,007,275 and nil held in the Trust Account.

**Concentration of Credit Risk**

Financial instruments that potentially subject the Company to concentrations of credit risk consist of a cash account in a financial institution, which, at times, may exceed the Federal Depository Insurance Corporation limit of \$250,000. At December 31, 2021, the Company has not experienced losses on this account and management believes the Company is not exposed to significant risks on such account.

**Offering Costs Associated with IPO**

The Company complies with the requirements of the ASC 340-10-S99-1 and SEC Staff Accounting Bulletin ("SAB") Topic 5A "Expenses of Offering". Offering costs consist principally of professional and registration fees incurred through the balance sheet date that are related to the Public Offering. Offering costs are charged to ordinary shares subject to possible redemption or the statement of operations based on the relative value of the Public and Private Warrants to the proceeds received from the Units and Private Placement Warrants sold upon the completion of the IPO. Accordingly, on December 31, 2021, offering costs totaling \$11,587,941 (consisting of \$4,000,000 of underwriting fees, \$7,000,000 of deferred underwriting fees and \$587,941 of other offering costs), of which \$507,417 was allocated to the Public Warrants and Private Warrants and was charged to operations in accordance with ASC 825-10 and \$11,080,524 was charged to ordinary shares subject to possible redemption.

**Derivative Financial Instruments**

The Company evaluates its financial instruments to determine if such instruments are derivatives or contain features that qualify as embedded derivatives in accordance with ASC Topic 815, "Derivatives and Hedging". For derivative financial instruments that are accounted for as liabilities, the derivative instrument is initially recorded at its fair value on the grant date and is then re-valued at each reporting date, with changes in the fair value reported in the statements of operations. The classification of derivative instruments, including whether such instruments should be recorded as liabilities or as equity, is evaluated at the end of each reporting period. Derivative liabilities are classified in the balance sheet as current or non-current based on whether or not net-cash settlement or conversion of the instrument could be required within 12 months of the balance sheet date.

**Warrant Liability and Forward Purchase Agreement**

The Company accounts for the 16,000,000 warrants issued in connection with the IPO (the 10,000,000 Public Warrants and the 6,000,000 Private Placement Warrants) and Forward Purchase Agreement ("FPA") in accordance with the guidance contained in FASB ASC 815 "Derivatives and Hedging" whereby under that provision the warrants and FPA do not meet the criteria for equity treatment and must be recorded as liabilities. Accordingly, the Company will classify warrants and FPA as liabilities at their fair value. These

liabilities are subject to re-measurement at each reporting period. With such re-measurement, the changes in fair value are recognized in the Statement of Operations in the period of change. Derivative warrant liabilities and FPA are classified as non-current liabilities as their liquidation is not reasonably expected to require the use of current assets or require the creation of current liabilities.

### Fair Value Measurements

The fair value of the Company's assets and liabilities, excluding the warrant liability and FPA liability, which qualify as financial instruments under FASB ASC Topic 820, Fair Value Measurement ("ASC 820"), approximates the carrying amounts represented in the accompanying balance sheet, primarily due to their short-term nature.

Fair value is defined as the price that would be received for sale of an asset or paid to transfer of a liability, in an orderly transaction between market participants at the measurement date. GAAP establishes a three-tier fair value hierarchy, which prioritizes the inputs used in measuring fair value. The hierarchy gives the highest priority to unadjusted quoted prices in active markets for identical assets or liabilities (Level 1 measurements) and the lowest priority to unobservable inputs (Level 3 measurements). These tiers include:

- Level 1, defined as observable inputs such as quoted prices (unadjusted) for identical instruments in active markets;
- Level 2, defined as inputs other than quoted prices in active markets that are either directly or indirectly observable such as quoted prices for similar instruments in active markets or quoted prices for identical or similar instruments in markets that are not active; and
- Level 3, defined as unobservable inputs in which little or no market data exists, therefore requiring an entity to develop its own assumptions, such as valuations derived from valuation techniques in which one or more significant inputs or significant value drivers are unobservable.

In some circumstances, the inputs used to measure fair value might be categorized within different levels of the fair value hierarchy. In those instances, the fair value measurement is categorized in its entirety in the fair value hierarchy based on the lowest level input that is significant to the fair value measurement.

### Class A Ordinary Shares Subject to Possible Redemption

The Company accounts for its Class A ordinary shares subject to possible redemption in accordance with the guidance in ASC Topic 480 "Distinguishing Liabilities from Equity." Ordinary shares subject to mandatory redemption (if any) are classified as a liability instrument and measured at fair value. Conditionally redeemable ordinary shares (including ordinary shares that feature redemption rights that are either within the control of the holder or subject to redemption upon the occurrence of uncertain events not solely within the Company's control) are classified as temporary equity. At all other times, ordinary shares are classified as shareholders' equity. The Company's Class A ordinary shares feature certain redemption rights that are considered to be outside of the Company's control and subject to the occurrence of uncertain future events. Accordingly, at December 31, 2021 and December 31, 2020, 20,000,000 and 0 Class A ordinary shares, respectively, subject to possible redemption are presented at redemption value as temporary equity, outside of the shareholders' equity section of the Company's balance sheet.

The Company recognizes changes in redemption value immediately as they occur and adjusts the carrying value of redeemable ordinary shares to equal the redemption value at the end of each reporting period.

At December 31, 2021, the Class A ordinary shares subject to possible redemption reflected in the balance sheets are reconciled in the following table:

Gross proceeds	\$200,000,000
Less: Proceeds allocated to Public Warrants	(8,511,409)
Less: Class A ordinary shares issuance costs	(11,080,524)
Add: Accretion of carrying value to redemption value	19,591,933
Class A ordinary shares subject to possible redemption	<u>\$200,000,000</u>

### Net Income (Loss) Per Share of Ordinary Shares

The Company has two classes of shares, which are referred to as Class A Ordinary Shares and Class B Ordinary Shares. Earnings and losses are shared pro rata between the two classes of shares. The 16,000,000 potential ordinary shares for outstanding warrants to purchase the Company's stock were excluded from diluted earnings per share for the year ended December 31, 2021 because the warrants are contingently exercisable, and the contingencies have not yet been met. As a result, diluted net income per ordinary share is the same as basic net income per ordinary share for the periods. The table below presents a reconciliation of the numerator and denominator used to compute basic and diluted net income per share for each class of ordinary shares:

	For the Year Ended December 31, 2021		For the Period from December 22, 2020 (Inception) to December 31, 2020	
	Class A	Class B	Class A	Class B
Basic and diluted net income per share:				
Numerator:				
Allocation of net loss	\$ (360,359)	\$ (185,368)	\$—	\$ (3,636)
Denominator:				
Weighted-average shares outstanding	11,178,082	5,750,000	—	5,750,000
Basic and diluted net loss per share	<u>\$ (0.03)</u>	<u>\$ (0.03)</u>	<u>\$—</u>	<u>\$ (0.00)</u>

### Income Taxes

ASC 740 clarifies the accounting for uncertainty in income taxes recognized in a Company's financial statements and prescribes a recognition threshold and measurement process for financial statement recognition and measurement of a tax position taken or expected to be taken in a tax return. For those benefits to be recognized, a tax position must be more-likely-than-not to be sustained upon examination by taxing authorities. ASC 740 also provides guidance on derecognition, classification, interest and penalties, accounting in interim period, disclosure and transition.

There is currently no taxation imposed on income by the Government of the Cayman Islands. In accordance with Cayman federal income tax regulations, income taxes are not levied on the Company. Consequently, income taxes are not reflected in the Company's financial statement. The Company's management does not expect that the total amount of unrecognized tax benefits will materially change over the next twelve months.

### Recent Accounting Pronouncements

In August 2020, the Financial Accounting Standards Board ("FASB") issued Accounting Standards Update ("ASU") 2020-06, Debt — Debt with Conversion and Other Options (Subtopic 470-20) and Derivatives and Hedging — Contracts in Entity's Own Equity (Subtopic 815-40) ("ASU 2020-06") to simplify accounting for certain financial instruments. ASU 2020-06 eliminates the current models that require separation of beneficial conversion and cash conversion features from convertible instruments and simplifies the derivative scope exception guidance pertaining to equity classification of contracts in an entity's own equity. The new standard also introduces additional disclosures for convertible debt and freestanding instruments that are indexed to and settled in an entity's own equity. ASU 2020-06 amends the diluted earnings per share guidance, including the requirement to use the if-converted method for all convertible instruments. ASU 2020-06 is effective January 1, 2024 and should be applied on a full or modified retrospective basis, with early adoption permitted beginning on January 1, 2021. The Company is currently assessing the impact, if any, that ASU 2020-06 would have on its financial position, results of operations or cash flows.

Management does not believe that any other recently issued, but not yet effective, accounting pronouncements, if currently adopted, would have a material effect on the Company's financial statements.

### Note 3 — Initial Public Offering

On June 11, 2021, the Company consummated its IPO of 20,000,000 Units (the "Units"), at a price of \$10.00 per unit, generating gross proceeds to the Company of \$200,000,000. Each Unit consists of one Class A

ordinary share and one-half of one redeemable warrant. Each whole warrant entitles the holder to purchase one Class A ordinary share at a price of \$11.50 per share, subject to adjustment. The warrants will become exercisable on the later of 30 days after the completion of the initial Business Combination or 12 months from the closing of the IPO, and will expire five years after the completion of the initial Business Combination or earlier upon redemption or liquidation (see Note 8).

#### **Note 4 — Private Placement**

Simultaneously with the closing of the IPO and the sale of the Units, the Company consummated the private placement (“Private Placement”) of an aggregate 6,000,000 Private Placement Warrants (“Private Placement Warrants”) at a price of \$1.00 per Private Placement Warrant, for an aggregate purchase price of \$6,000,000. If the Company does not complete an initial Business Combination within the Combination Period, the Private Placement Warrants will expire worthless. The Private Placement Warrants will be non-redeemable by the Company and exercisable on a cashless basis so long as they are held by the Sponsor or its permitted transferees.

If the Private Placement Warrants are held by holders other than the Sponsor or its permitted transferees, the Private Placement Warrants will be redeemable by the Company in all redemption scenarios and exercisable by the holders on the same basis as the warrants included in the units being sold in the IPO.

#### **Note 5 — Related Party Transactions**

##### **Founder Shares**

On December 31, 2020, the Company issued to the Sponsor 5,750,000 Class B ordinary shares, par value \$0.0001 (the “Founder Shares”), for \$25,000 for certain expenses paid on behalf of the Company, or approximately \$0.004 per share. On April 30, 2021, the Company effected a share capitalization, pursuant to which the Company’s initial shareholders held an aggregate of 6,500,000 Class B ordinary shares. The accompanying financial statements have been retroactively adjusted to reflect the stock dividend in the share capitalization. On April 30, 2021, the Company entered into forward purchase agreements (see Note 6) with anchor investors, in connection with entering into the forward purchase agreements, the Sponsor transferred to the anchor investors an aggregate of 375,000 Class B ordinary shares for no cash. On April 30, 2021, the Sponsor transferred 25,000 Class B ordinary shares each to three independent director nominees. Up to 750,000 Founder Shares were subject to forfeiture by the Sponsor depending on the extent to which the underwriters’ over-allotment option is exercised. On July 23, 2021, the Sponsor surrendered 750,000 Founder Shares, with no return of capital or payment by the Sponsor, after the expiration of the unexercised underwriters’ over-allotment option. As a result of the foregoing, at December 31, 2021 and December 31, 2020, the Sponsor owned 5,750,000 and 6,500,000 Class B ordinary shares, respectively.

The Sponsor, officers and directors have agreed not to transfer, assign or sell any of their Founder Shares until earliest of (A) one year after the completion of the initial Business Combination and (B) subsequent to the initial Business Combination, (x) if the closing price of the Company’s Class A ordinary shares equals or exceeds \$12.00 per share (as adjusted for share subdivisions, share capitalizations, reorganizations, recapitalizations and the like) for any 20 trading days within any 30-trading day period commencing at least 150 days after the initial Business Combination, or (y) the date on which the Company completes a liquidation, merger, share exchange or other similar transaction that results in all of the Company’s public shareholders having the right to exchange their ordinary shares for cash, securities or other property (the “Lock-up”). Any permitted transferees would be subject to the same restrictions and other agreements of our Sponsor, officers and directors with respect to any Founder Shares.

##### **Promissory Note — Related Party**

The Sponsor has agreed to loan the Company up to \$300,000 to be used for a portion of the expenses of the IPO. These loans were non-interest bearing, unsecured and were due at the earlier of September 30, 2021 or the closing of the IPO. The loan was to be repaid upon completion of the IPO out of the \$1,000,000 of offering proceeds that has been allocated to the payment of offering expenses. The Company had drawn down \$140,068 under the promissory note which was fully repaid as of June 11, 2021. The note was terminated at June 11, 2021.

### Related Party Loans

In addition, in order to finance transaction costs in connection with an intended initial Business Combination, the Sponsor or an affiliate of the Sponsor, or certain of the Company's officers and directors may, but are not obligated to, loan the Company funds as may be required ("Working Capital Loans"). If the Company completes the initial Business Combination, the Company may repay the Working Capital Loans out of the proceeds of the Trust Account released to the Company. In the event that the initial Business Combination does not close, the Company may use a portion of the working capital held outside the Trust Account to repay the Working Capital Loans but no proceeds from the Trust Account would be used to repay the Working Capital Loans. Up to \$1,500,000 of such Working Capital Loans may be convertible into warrants at a price of \$1.00 per warrant at the option of the lender. Such warrants would be identical to the Private Placement Warrants. As of December 31, 2021 and December 31, 2020, the Company had no borrowings under the Working Capital Loans.

### Administrative Service Fee

Commencing on the Effective Date, the Company paid an affiliate of the Sponsor \$10,000 per month for office space, utilities, administrative services and remote support services. Upon completion of the initial Business Combination or the Company's liquidation, the Company will cease paying these monthly fees. The Company accrued \$67,667 for the administrative service fee for the period from June 8, 2021 (the Effective Date) to December 31, 2021.

### Note 7—Recurring Fair Value Measurements

#### Warrant Liability and FPA Liability

At December 31, 2021, the fair value of Company's Warrant liability was \$10,423,429, and the fair value of FPA liability was \$2,785,941. Under the guidance in ASC 815-40 the Public and Private Warrants and the FPA do not meet the criteria for equity treatment. As such, the Public and Private Warrants and the FPA must be recorded on the balance sheet at fair value. This valuation is subject to re-measurement each balance sheet date. With each re-measurement, the valuations will be adjusted to fair value, with the change in fair value recognized in the Company's statement of operations.

#### Recurring Fair Value Measurements

The following table presents fair value information as of December 31, 2021 of the Company's financial assets and liabilities that were accounted for at fair value on a recurring basis and indicates the fair value hierarchy of the valuation techniques the Company utilized to determine such fair value. The Company's Warrant liability is based on a valuation models utilizing management judgment and pricing inputs from observable and unobservable markets with less volume and transaction frequency than active markets. Significant deviations from these estimates and inputs could result in a material change in fair value. The fair value of the Warrant liability and FPA liability is classified within Level 3 of the fair value hierarchy. The investments held in Trust Account includes money market funds. The Company uses inputs such as actual trade data, benchmark yields, quoted market prices from dealers or brokers, and other similar sources to determine the fair value of its level 1 investments.

The following table sets forth by level within the fair value hierarchy the Company's assets and liabilities as of December 31, 2021, that were accounted for at fair value on a recurring basis:

	(Level 1)	(Level 2)	(Level 3)
<b>Assets</b>			
Investments held in Trust Account	\$200,007,275	\$ —	\$ —
<b>Liabilities</b>			
Public Warrants	\$ —	\$6,500,000	\$ —
Private Warrants	\$ —	\$ —	\$3,923,429
FPA liability	\$ —	\$ —	\$2,785,941

### Measurement of the Warrants

The Company established the initial fair value for the Warrants on June 11, 2021, the date of the consummation of the Company's IPO. The Company used a Monte Carlo simulation model to value the Warrants. The Company allocated the proceeds received from (i) the sale of Units (which is inclusive of one Class A ordinary share and one-half of one Public Warrant), (ii) the sale of Private Warrants, and (iii) the issuance of Class B ordinary shares, first to the Warrants based on their fair values as determined at initial measurement, with the remaining proceeds allocated to Class A ordinary shares subject to possible redemption (temporary equity), and Class B ordinary shares (permanent equity) based on their relative fair values at the initial measurement date. The estimated fair value of the Public Warrants was transferred from a Level 3 measurement to a Level 1 measurement in August 2021 after detachment of the Public Warrants from the Units and were separately listed and traded. As of December 31, 2021, the Public Warrants were valued using the observed price for Public Warrants and the Private Warrants were valued using a Monte Carlo simulation model.

The key inputs for the valuation of Public and Private Warrants are as follows:

<b>Input</b>	<b>June 11, 2021</b>	<b>December 31, 2021</b>
Volatility	16.30%	13.4%
Risk Free Rate	0.89%	1.29%
Stock Price	\$ 9.57	\$9.72
Est. Term Remaining (Yrs)	5.65	5.35

The following table provides a reconciliation of changes in fair value of the beginning and ending balances of the Company's derivative warrant liabilities classified as Level 3:

	<b>Warrant liabilities</b>
Fair value at January 1, 2021	\$ —
Initial value at IPO date	13,712,964
Change in fair value	(3,289,535)
Transfer of Public warrants from Level 3 to Level 1	(6,500,000)
Fair Value at December 31, 2021	\$ 3,923,429

### FPA

To arrive the conclusion of Fair Value of the Forward Purchase Agreements, the Company analyzed the agreements and other documentation. The Company utilized the underlying shares and warrant values determined above and the following inputs in order to project the net asset or liability value of the FPA:

<b>Input</b>	<b>June 11, 2021</b>	<b>December 31, 2021</b>
Volatility	16.30%	13.4%
Stock Price	\$ 9.57	\$ 9.72
Warrant Price	\$ 0.85	\$ 0.65
Est. Term to Business Combination (Yrs)	0.65	0.33
Probability of Business Combination	85%	85%
Purchase price of FPA unit	\$10.00	\$10.00



The following table provides a reconciliation of changes in fair value of the beginning and ending balances of the Company's FPA liability classified as Level 3:

	FPA liability
Fair value at January 1, 2021	\$ —
Initial value at IPO date	2,322,741
Change in fair value	463,200
Fair Value at December 31, 2021	\$2,785,941

Transfers between levels of the fair value hierarchy are recognized at the end of the reporting period.

## Note 7 — Commitments & Contingencies

### Risks and Uncertainties

Management continues to evaluate the impact of the COVID-19 pandemic on the industry and has concluded that while it is reasonably possible that the virus could have a negative effect on the Company's financial position, results of its operations and/or search for a target company, the specific impact is not readily determinable as of the date of this financial statement. The financial statement does not include any adjustments that might result from the outcome of this uncertainty.

### Registration Rights

The holders of the Founder Shares, Private Placement Warrants and any warrants that may be issued upon conversion of Working Capital Loans (and any Class A ordinary shares issuable upon the exercise of the Private Placement Warrants and warrants that may be issued upon conversion of Working Capital Loans) will be entitled to registration rights pursuant to a registration and shareholder rights agreement to be signed prior to or on the effective date of the IPO. The holders of these securities are entitled to make up to three demands, excluding short form demands, that the Company registers such securities. In addition, the holders have certain "piggy-back" registration rights with respect to registration statements filed subsequent to the Company's completion of its initial Business Combination. However, the registration and shareholder rights agreement provides that the Company will not permit any registration statement filed under the Securities Act to become effective until termination of the applicable Lock-up period, which occurs (i) in the case of the Founder Shares, and (ii) in the case of the Private Placement Warrants and the respective Class A ordinary shares underlying such warrants, 30 days after the completion of the initial Business Combination. The Company will bear the expenses incurred in connection with the filing of any such registration statements.

### Underwriters Agreement

The underwriters had a 45-day option to purchase up to an additional 3,000,000 units to cover over-allotments, if any. The over-allotment option expired unexercised on July 23, 2021.

The underwriters were paid a cash underwriting discount of two percent (2%) of the gross proceeds of the IPO, or \$4,000,000. Additionally, the underwriters are entitled to a deferred underwriting discount of 3.5% of the gross proceeds of the IPO upon the completion of the Company's initial Business Combination.

### Forward Purchase Agreements

On April 30, 2021, the Company entered into forward purchase agreements with the Sponsor, Snow Lake Capital (HK) Limited and Valliance Fund (the "anchor investors"), pursuant to which the anchor investors agreed to subscribe for an aggregate of 3,000,000 Class A ordinary shares plus 750,000 redeemable warrants for a purchase price of \$10.00 multiplied by the number of Class A ordinary shares, or \$30,000,000 in the aggregate, in a private placement to close concurrently with the closing of the initial business combination. The Company issued 750,000 additional Class B ordinary shares to the Sponsor, which represent the adjustment to the ratio applicable to the conversion of the Class B ordinary shares that the Sponsor would have been entitled to at the closing of the initial business combination as a result of the issuance of 3,000,000 additional Class A ordinary shares under the forward purchase agreements. As a result, the issuance of the

Class A ordinary shares at the closing of the initial business combination will not trigger a further adjustment to this ratio. Further, prior to the IPO, the Sponsor transferred to the anchor investors an aggregate of 375,000 Founder Shares for no cash consideration. Subject to certain exceptions to forfeiture and transfer provisions, the Founder Shares transferred in connection with these agreements are subject to similar contractual conditions and restrictions as the Founder Shares issued to the Sponsor in connection with the IPO. The forward purchase warrants will have the same terms as the public warrants.

The forward purchase agreements provide that the anchor investors are entitled to registration rights with respect to the forward purchase securities and Class A ordinary shares underlying the forward purchase warrants and founder shares.

The proceeds from the sale of the forward purchase securities may be used as part of the consideration to the sellers in the initial Business Combination, expenses in connection with the initial Business Combination or for working capital in the post Business Combination company. These purchases will be required to be made regardless of whether any Class A ordinary shares are redeemed by the public shareholders and are intended to provide the Company with a minimum funding level for the initial Business Combination. The anchor investors will not have the ability to approve the initial Business Combination prior to the signing of a material definitive agreement and, if the Company seeks shareholder approval, have agreed to vote their Founder Shares and any public shares held by them in favor of the initial Business Combination. The forward purchase securities will be issued only in connection with the closing of the initial Business Combination.

#### **Note 8 — Warrant Liability**

As of December 31, 2021, 16,000,000 warrants (the 10,000,000 Public Warrants and the 6,000,000 Private Placement Warrants) are outstanding. Each warrant entitles the holder to purchase one Class A ordinary share at a price of \$11.50 per share, subject to adjustment as discussed herein. The warrants will become exercisable on the later of 12 months from the closing of the IPO or 30 days after the completion of its initial Business Combination, and will expire five years after the completion of the Company's initial Business Combination or earlier upon redemption or liquidation

##### *Redemption of warrants when the price per Class A ordinary share equals or exceeds \$18.00.*

Once the warrants become exercisable, the Company may redeem the outstanding warrants (except as described herein with respect to the Private Placement Warrants):

- in whole and not in part;
- at a price of \$0.01 per warrant;
- upon a minimum of 30 days' prior written notice of redemption to each warrant holder; and
- if, and only if, the closing price of the Class A ordinary shares equals or exceeds \$18.00 per share (as adjusted for adjustments to the number of shares issuable upon exercise or the exercise price of a warrant) for any 20 trading days within a 30-trading day period ending three trading days before the Company sends the notice of redemption to the warrant holders.

If and when the warrants become redeemable by the Company, the Company may exercise its redemption right even if it is unable to register or qualify the underlying securities for sale under all applicable state securities laws.

##### *Redemption of warrants when the price per Class A ordinary share equals or exceeds \$10.00*

Once the warrants become exercisable, the Company may redeem the outstanding warrants:

- in whole and not in part;
- at \$0.10 per warrant upon a minimum of 30 days' prior written notice of redemption provided that holders will be able to exercise their warrants on a cashless basis prior to redemption and receive that number of shares determined by reference to the table below, based on the redemption date and the "fair market value" of the Class A ordinary shares;

- if, and only if, the closing price of our Class A ordinary shares equals or exceeds \$10.00 per public share (as adjusted for adjustments to the number of shares issuable upon exercise or the exercise price of a warrant) for any 20 trading days within the 30-trading day period ending three trading days before the Company sends the notice of redemption to the warrant holders; and
- if the closing price of the Class A ordinary shares for any 20 trading days within a 30-trading day period ending on the third trading day prior to the date on which the Company sends the notice of redemption to the warrant holders is less than \$18.00 per share (as adjusted for adjustments to the number of shares issuable upon exercise or the exercise price of a warrant), the Private Placement Warrants must also be concurrently called for redemption on the same terms as the outstanding public warrants, as described above.

In addition, if (x) the Company issues additional Class A ordinary shares or equity-linked securities for capital raising purposes in connection with the closing of the initial Business Combination at an issue price or effective issue price of less than \$9.20 per ordinary share (with such issue price or effective issue price to be determined in good faith by the Company's board of directors and in the case of any such issuance to the Company's Sponsors or its affiliate, without taking into account any Founder Shares held by the Company's Sponsor or such affiliates, as applicable, prior to such issuance (the "Newly Issued Price"), (y) the aggregate gross proceeds from such issuances represent more than 60% of the total equity proceeds, and interest thereon, available for the funding of the initial Business Combination on the date of the completion of the initial Business Combination (net of redemptions), and (z) the volume weighted average trading price of the Company's Class A ordinary shares during the 20 trading day period starting on the trading day prior to the day on which the Company consummates its initial Business Combination (such price, the "Market Value") is below \$9.20 per share, the exercise price of the warrants will be adjusted (to the nearest cent) to be equal to 115% of the higher of the Market Value and the Newly Issued Price, and the \$18.00 per share redemption trigger price described above will be adjusted (to the nearest cent) to be equal to 180% of the higher of the Market Value and the Newly Issued Price, and the \$10.00 per share redemption trigger price described above will be adjusted (to the nearest cent) to be equal to the higher of the Market Value and the Newly Issued Price.

#### **Note 9 — Shareholders' (Deficit) Equity**

##### **Preference shares**

The Company is authorized to issue 5,000,000 preference shares with a par value of \$0.0001 and with such designations, voting and other rights and preferences as may be determined from time to time by the Company's board of directors. As of December 31, 2021 and December 30, 2020, there were no preference shares issued or outstanding.

##### **Class A Ordinary Shares**

The Company is authorized to issue 500,000,000 Class A ordinary shares with a par value of \$0.0001 per share. As of December 31, 2021 and 2020, there were 20,000,000 and 0 Class A ordinary shares issued and outstanding, including the 20,000,000 and 0 shares presented in ordinary shares subject to redemption.

##### **Class B Ordinary Shares**

The Company is authorized to issue 50,000,000 Class B ordinary shares with a par value of \$0.0001 per share. Holders are entitled to one vote for each share of Class B ordinary shares. As of December 31, 2021 and December 31, 2020, there were 5,750,000 and 6,500,000 Class B ordinary shares issued and outstanding, respectively. Of the 6,500,000 Class B ordinary shares, an aggregate of up to 750,000 shares were subject to forfeiture to the Company for no consideration to the extent that the underwriters' over-allotment option was not exercised in full or in part, so that the initial shareholders will collectively own 20% of the Company's issued and outstanding ordinary shares after the IPO. On July 23, 2021, the Sponsor surrendered 750,000 Founder Shares, with no return of capital or payment by the Sponsor, after the expiration of the unexercised underwriters' over-allotment option.

Class A ordinary shareholders and Class B ordinary shareholders of record are entitled to one vote for each share held on all matters to be voted on by shareholders and vote together as a single class, except as required

by law. Prior to the initial Business Combination, only holders of the Founder Shares will have the right to vote on the election of directors. Holders of the public shares will not be entitled to vote on the appointment of directors during such time. In addition, prior to the completion of an initial Business Combination, holders of a majority of the Founder Shares may remove a member of the board of directors for any reason.

The Class B ordinary shares will automatically convert into Class A ordinary shares (which such Class A ordinary shares delivered upon conversion will not have redemption rights or be entitled to liquidating distributions from the Trust Account if the Company does not consummate an initial Business Combination) at the time of the initial Business Combination or earlier at the option of the holders thereof at a ratio such that the number of Class A ordinary shares issuable upon conversion of all Founder Shares will equal, in the aggregate, on an as-converted basis, 20% of the sum of (i) the total number of ordinary shares issued and outstanding upon the completion of the IPO, plus (ii) the total number of Class A ordinary shares issued or deemed issued or issuable upon conversion or exercise of any equity-linked securities or rights issued or deemed issued, by the Company in connection with or in relation to the consummation of the initial Business Combination, excluding any Class A ordinary shares or equity-linked securities exercisable for or convertible into Class A ordinary shares issued, deemed issued or to be issued to any seller in the initial Business Combination and any Private Placement Warrants issued to the Sponsor, its affiliates or any member of our management team upon conversion of Working Capital Loans. In no event will the Class B ordinary shares convert into Class A ordinary shares at a rate of less than one-to-one.

#### **Note 10— Subsequent Events**

The Company evaluated subsequent events and transactions that occurred after the balance sheet date up to the date that the financial statements were issued. Based on this review, other than disclosed below, the Company did not identify any subsequent events that would have required adjustment or disclosure in the financial statement.

On February 24, 2022, Russian forces launched significant military action against Ukraine, and sustained conflict and disruption in the region is possible. The impact to Ukraine as well as actions taken by other countries, including new and stricter sanctions imposed by Canada, the United Kingdom, the European Union, the U.S. and other countries and companies and organizations against officials, individuals, regions, and industries in Russia and Ukraine, and actions taken by Russia in response to such sanctions, and each country's potential response to such sanctions, tensions, and military actions could have a material adverse effect on the business or prospects of potential target companies in Europe as the Company's efforts to identify a prospective target business are not be limited to a particular geographic region. Any such material adverse effect from the conflict and enhanced sanctions activity may include reduced trading and business activity levels, disruption of financial markets, increased costs, disruption of services, inability to complete financial or banking transactions, and inability to service existing or new customers in the region. Prolonged unrest, military activities, or broad-based sanctions, should they be implemented, could have a material adverse effect on our ability to complete a business combination with a suitable target.

**YISHENGBIO CO., LTD AND SUBSIDIARIES**  
**INDEX TO CONSOLIDATED FINANCIAL STATEMENTS**

<b>CONTENTS</b>	<b>Page(s)</b>
<a href="#"><u>Report of Independent Registered Public Accounting Firm (PCA0B 2388)</u></a>	<a href="#"><u>F-42</u></a>
<a href="#"><u>Consolidated Balance Sheets as of March 31, 2022 and 2021</u></a>	<a href="#"><u>F-43</u></a>
<a href="#"><u>Consolidated Statements of Operations and Comprehensive Loss for the Years Ended March 31, 2022 and 2021</u></a>	<a href="#"><u>F-45</u></a>
<a href="#"><u>Consolidated Statements of Changes in Shareholders' Deficit for the Years Ended March 31, 2022 and 2021</u></a>	<a href="#"><u>F-46</u></a>
<a href="#"><u>Consolidated Statements of Cash Flows for the Years Ended March 31, 2022 and 2021</u></a>	<a href="#"><u>F-47</u></a>
<a href="#"><u>Notes to the Consolidated Financial Statements</u></a>	<a href="#"><u>F-48</u></a>
<a href="#"><u>Condensed Consolidated Balance Sheets as of September 30, 2022 (Unaudited) and March 31, 2022</u></a>	<a href="#"><u>F-81</u></a>
<a href="#"><u>Unaudited Condensed Consolidated Statements of Operations and Comprehensive Loss for the Six Months Ended September 30, 2022 and 2021</u></a>	<a href="#"><u>F-82</u></a>
<a href="#"><u>Unaudited Condensed Consolidated Statements of Changes in Shareholders' Deficit for the Six Months Ended September 30, 2022 and 2021</u></a>	<a href="#"><u>F-83</u></a>
<a href="#"><u>Unaudited Condensed Consolidated Statements of Cash Flows for the Six Months Ended September 30, 2022 and 2021</u></a>	<a href="#"><u>F-84</u></a>
<a href="#"><u>Notes to Unaudited Condensed Consolidated Financial Statements</u></a>	<a href="#"><u>F-85</u></a>



• **MAIN OFFICE**  
133-10 39<sup>TH</sup> Avenue  
Flushing, NY 11354  
Tel. (718) 445-6308  
Fax. (718) 445-6760

• **CALIFORNIA OFFICE**  
440 E Huntington Drive  
Suite 300  
Arcadia, CA 91006  
Tel. (626) 282-1630  
Fax. (626) 282-9726

• **BEIJING OFFICE**  
11/F North Tower  
Beijing Kerry Centre  
1 Guanghua Road  
Chaoyang District  
Beijing, 100020, PRC  
Tel. (86 10) 65997923  
Fax. (86 10) 65999100

## REPORT OF INDEPENDENT REGISTERED PUBLIC ACCOUNTING FIRM

To the Board of Directors and Shareholders of  
YishengBio Co., Ltd.

### Opinion on the Financial Statements

We have audited the accompanying consolidated balance sheets of YishengBio Co., Ltd. and Subsidiaries (the “Company”) as of March 31, 2022 and 2021, and the related consolidated statements of operations and comprehensive loss, changes in shareholders’ deficit, and cash flows for each of the years in the two-year period ended March 31, 2022, and the related notes (collectively referred to as the financial statements). In our opinion, the financial statements present fairly, in all material respects, the financial position of the Company as of March 31, 2022 and 2021, and the results of its operations and its cash flows for each of the years in the two-year period ended March 31, 2022, in conformity with accounting principles generally accepted in the United States of America.

### Convenience Translation

Our audits also comprehended the translation of Renminbi amounts into United States dollar amounts and, in our opinion, such translation has been made in conformity with the basis stated in Note 3 to the financial statements. Such United States dollar amounts are presented solely for the convenience of readers outside the People’s Republic of China.

### Basis for Opinion

These financial statements are the responsibility of the Company’s management. Our responsibility is to express an opinion on the Company’s financial statements based on our audits. We are a public accounting firm registered with the Public Company Accounting Oversight Board (United States) (PCAOB) and are required to be independent with respect to the Company in accordance with the U.S. federal securities laws and the applicable rules and regulations of the Securities and Exchange Commission and the PCAOB.

We conducted our audits in accordance with the standards of the PCAOB. Those standards require that we plan and perform the audit to obtain reasonable assurance about whether the financial statements are free of material misstatement, whether due to error or fraud. The Company is not required to have, nor were we engaged to perform, an audit of its internal control over financial reporting. As part of our audits, we are required to obtain an understanding of internal control over financial reporting, but not for the purpose of expressing an opinion on the effectiveness of the Company’s internal control over financial reporting. Accordingly, we express no such opinion.

Our audits included performing procedures to assess the risks of material misstatement of the financial statements, whether due to error or fraud, and performing procedures that respond to those risks. Such procedures included examining, on a test basis, evidence regarding the amounts and disclosures in the financial statements. Our audits also included evaluating the accounting principles used and significant estimates made by management, as well as evaluating the overall presentation of the financial statements. We believe that our audits provide a reasonable basis for our opinion.

/s/ Wei, Wei & Co., LLP  
Flushing, New York  
September 28, 2022

We have served as the Company’s auditor since 2022.

**YISHENGBIO CO., LTD AND SUBSIDIARIES**  
**CONSOLIDATED BALANCE SHEETS**

	As of March 31,		
	2021	2022	2022
	(RMB)	(RMB)	(US\$)
<b>ASSETS</b>			
<b>Current assets</b>			
Cash	390,457,084	271,067,503	\$ 42,699,900
Accounts receivable, net	214,502,737	308,555,105	48,605,133
Advance to suppliers	11,458,564	10,648,306	1,677,374
Amounts due from related party	30,088,833	—	—
Inventories, net	81,439,883	166,505,565	26,228,784
Prepaid expenses and other current assets	5,257,185	7,987,914	1,258,295
<b>Total current assets</b>	<b>733,204,286</b>	<b>764,764,393</b>	<b>120,469,486</b>
<b>Non-current assets</b>			
Property, plant and equipment, net	236,204,959	550,153,110	86,662,851
Operating lease right-of-use assets, net	17,245,924	14,850,283	2,339,290
Deferred tax assets, net	7,976,206	3,039,084	478,732
Intangible assets, net	83,778,603	80,717,978	12,715,097
Other assets, non-current	88,765,094	28,228,293	4,446,661
<b>Total non-current assets</b>	<b>433,970,786</b>	<b>676,988,748</b>	<b>106,642,631</b>
<b>Total assets</b>	<b>1,167,175,072</b>	<b>1,441,753,141</b>	<b>\$ 227,112,117</b>
<b>LIABILITIES, MEZZANINE EQUITY AND SHAREHOLDERS' DEFICIT</b>			
<b>Current liabilities</b>			
Bank loans and other borrowing – current	—	111,733,754	\$ 17,600,856
Accounts payable	16,383,236	30,811,100	4,853,518
Accrued expenses and other liabilities	322,750,471	326,751,353	51,471,496
Operating lease liabilities – current	3,785,642	4,322,252	680,863
Deferred government grants – current	2,121,645	2,295,701	361,630
<b>Total current liabilities</b>	<b>345,040,994</b>	<b>475,914,160</b>	<b>74,968,363</b>
<b>Non-current liabilities</b>			
Bank loans and other borrowing – non-current	1,103,609	253,928,000	40,000,000
Operating lease liabilities – non-current	13,550,359	10,605,260	1,670,593
Deferred government grants – non-current	30,884,246	30,053,517	4,734,179
<b>Total non-current liabilities</b>	<b>45,538,214</b>	<b>294,586,777</b>	<b>46,404,772</b>
<b>Total liabilities</b>	<b>390,579,208</b>	<b>770,500,937</b>	<b>121,373,135</b>

The accompanying notes are an integral part of these consolidated financial statements.

	As of March 31,		
	2021	2022	2022
	(RMB)	(RMB)	(US\$)
<b>Mezzanine equity</b>			
Series A and Series A-1 redeemable convertible preferred shares (par value US\$0.000005 per share, 50,000,000 shares authorized; 21,548,589 shares issued and outstanding)	410,327,208	458,074,468	72,158,166
Series B redeemable convertible preferred shares (par value US\$0.000005 per share, 100,000,000 shares authorized; 65,414,858 shares issued and outstanding)	875,131,363	912,146,924	143,685,915
<b>Total mezzanine equity</b>	<b>1,285,458,571</b>	<b>1,370,221,392</b>	<b>215,844,081</b>
<b>Commitments and Contingencies</b>	—	—	—
<b>Shareholders' deficit</b>			
Ordinary shares, par value US\$0.000005 per share, 9,950,000,000 shares authorized, 247,311,533 shares issued and outstanding*	7,978	7,978	1,257
Additional paid-in capital	800,806,378	808,502,018	127,359,254
Accumulated Deficit	(1,353,900,436)	(1,590,567,163)	(250,554,041)
Accumulated other comprehensive income	44,223,373	83,087,979	13,088,431
<b>Total shareholders' deficit</b>	<b>(508,862,707)</b>	<b>(698,969,188)</b>	<b>(110,105,099)</b>
<b>Total liabilities, mezzanine equity and shareholders' deficit</b>	<b>1,167,175,072</b>	<b>1,441,753,141</b>	<b>\$ 227,112,117</b>

\* Gives retroactive effect to reflect the reorganization in February 2021.

The accompanying notes are an integral part of these consolidated financial statements.



**YISHENGBIO CO., LTD AND SUBSIDIARIES**  
**CONSOLIDATED STATEMENTS OF OPERATIONS AND COMPREHENSIVE LOSS**

	For the Fiscal Years Ended March 31,		
	2021	2022	2022
	(RMB)	(RMB)	(US\$)
<b>Revenues</b>	<b>257,015,929</b>	<b>502,949,894</b>	<b>\$ 79,227,166</b>
Cost of revenues	59,656,877	117,066,090	18,440,832
<b>Gross profit</b>	<b>197,359,052</b>	<b>385,883,804</b>	<b>60,786,334</b>
<b>Operating expenses:</b>			
Selling	73,485,259	185,999,704	29,299,597
General and administrative	155,334,386	107,620,500	16,952,916
Research and development	94,387,144	211,222,263	33,272,780
<b>Total operating expenses</b>	<b>323,206,789</b>	<b>504,842,467</b>	<b>79,525,293</b>
<b>Loss from operations</b>	<b>(125,847,737)</b>	<b>(118,958,663)</b>	<b>(18,738,959)</b>
<b>Other income (expenses):</b>			
Late fees related to income tax	(11,464,741)	—	—
Late fees related to taxes other than income tax	(7,261,947)	(231,231)	(36,425)
Late fees related to social security insurance	(7,701,793)	(1,852,378)	(291,796)
Government grants	3,530,405	23,020,413	3,626,290
Financial expenses, net	(29,689,927)	(2,717,433)	(428,064)
Other income (expenses), net	4,063,743	(327,987)	(51,666)
<b>Total other (expenses) income, net</b>	<b>(48,524,260)</b>	<b>17,891,384</b>	<b>2,818,339</b>
<b>Loss before income taxes</b>	<b>(174,371,997)</b>	<b>(101,067,279)</b>	<b>(15,920,620)</b>
<b>Income tax expense</b>	<b>(17,454,245)</b>	<b>(4,937,122)</b>	<b>(777,720)</b>
<b>Net loss</b>	<b>(191,826,242)</b>	<b>(106,004,401)</b>	<b>(16,698,340)</b>
Accretion to redemption value of convertible redeemable preferred shares	(16,610,297)	(130,662,326)	(20,582,579)
<b>Net loss attributable to YishengBio Co. Ltd</b>	<b>(208,436,539)</b>	<b>(236,666,727)</b>	<b>\$ (37,280,919)</b>
<b>Net loss</b>	<b>(191,826,242)</b>	<b>(106,004,401)</b>	<b>\$ (16,698,340)</b>
Other comprehensive income: foreign currency translation gain	22,455,217	38,864,606	6,122,146
<b>Total comprehensive loss</b>	<b>(169,371,025)</b>	<b>(67,139,795)</b>	<b>\$ (10,576,194)</b>
<b>Loss per share*:</b>			
– Basic and Diluted	(0.78)	(0.43)	\$ (0.07)
<b>Weighted average number of ordinary shares outstanding*:</b>			
– Basic and Diluted	247,311,533	247,311,533	247,311,533

\* Gives retroactive effect to reflect the reorganization in February 2021.

The accompanying notes are an integral part of these consolidated financial statements.

**YISHENGBIO CO., LTD AND SUBSIDIARIES**  
**CONSOLIDATED STATEMENTS OF CHANGES IN SHAREHOLDERS' DEFICIT**

	Ordinary shares*		Additional paid-in capital	Deficit	Accumulated other comprehensive income	Total stockholders' deficit
	Shares	Amount				
		(RMB)	(RMB)	(RMB)	(RMB)	(RMB)
<b>Balance as of March 31, 2020</b>	<b>212,883,618</b>	<b>6,797</b>	<b>276,368,115</b>	<b>(1,145,463,897)</b>	<b>21,768,156</b>	<b>(847,320,829)</b>
Shareholders' contribution	34,427,915	1,181	447,681,763	—	—	447,682,944
Accretion to redemption value of convertible redeemable preferred shares	—	—	—	(16,610,297)	—	(16,610,297)
Net loss	—	—	—	(191,826,242)	—	(191,826,242)
Share-based compensation	—	—	76,756,500	—	—	76,756,500
Foreign currency translation adjustment	—	—	—	—	22,455,217	22,455,217
<b>Balance as of March 31, 2021</b>	<b>247,311,533</b>	<b>7,978</b>	<b>800,806,378</b>	<b>(1,353,900,436)</b>	<b>44,223,373</b>	<b>(508,862,707)</b>
Accretion to redemption value of convertible redeemable preferred shares	—	—	—	(130,662,326)	—	(130,662,326)
Net loss	—	—	—	(106,004,401)	—	(106,004,401)
Share-based compensation	—	—	7,764,448	—	—	7,764,448
Foreign currency translation adjustment	—	—	(68,808)	—	38,864,606	38,795,798
<b>Balance as of March 31, 2022 (in RMB)</b>	<b>247,311,533</b>	<b>7,978</b>	<b>808,502,018</b>	<b>(1,590,567,163)</b>	<b>83,087,979</b>	<b>(698,969,188)</b>
<b>Balance as of March 31, 2022 (in US\$)</b>	<b>247,311,533</b>	<b>\$1,257</b>	<b>\$127,359,254</b>	<b>\$ (250,554,041)</b>	<b>\$ 13,088,431</b>	<b>\$(110,105,099)</b>

\* Gives retroactive effect to reflect the reorganization in February 2021.

The accompanying notes are an integral part of these consolidated financial statements.

**YISHENGBIO CO., LTD AND SUBSIDIARIES**  
**CONSOLIDATED STATEMENTS OF CASH FLOWS**

	For the Fiscal Years Ended March 31,		
	2021 (RMB)	2022 (RMB)	2022 (US\$)
<b>Cash flows from operating activities:</b>			
Net loss	(191,826,242)	(106,004,401)	\$(16,698,340)
Adjustments to reconcile net loss to net cash used in operating activities:			
Deferred income taxes	17,454,245	4,937,120	777,720
Depreciation of property, plant and equipment	22,240,060	24,475,736	3,855,540
Amortization of intangible assets	5,665,735	6,678,233	1,051,988
Loss on disposal of property, plant and equipment	24,876	273,982	43,159
Share-based compensation	76,756,500	7,764,448	1,223,094
Impairment of accounts receivable	6,414,634	5,084,925	801,003
Write-down of inventories to net realizable value	1,109,400	4,393,630	692,106
Non-cash lease expense	2,233,089	3,787,628	596,646
Changes in operating assets and liabilities:			
Inventories	(68,728,378)	(89,459,313)	(14,092,075)
Accounts receivable	(220,734,141)	(99,137,291)	(15,616,599)
Amounts due from related parties	(3,086,330)	30,088,833	4,739,742
Prepaid expenses and other current assets	146,767,686	59,229,801	9,330,172
Accounts payable	(4,424,337)	14,427,864	2,272,749
Amounts due to related parties	(245,808)	—	—
Accrued expenses and other liabilities	140,210	(35,633,487)	(5,613,164)
Deferred government grants	(44,290)	(656,673)	(103,442)
Income taxes payable	(34,105,055)	—	—
Operating lease liabilities	(2,222,291)	(3,796,392)	(598,027)
<b>Net cash used in operating activities</b>	<b>(246,610,437)</b>	<b>(173,545,357)</b>	<b>(27,337,727)</b>
<b>Cash flows from investing activities:</b>			
Proceeds from disposal of property, plant and equipment	644,842	8,000	1,260
Purchases of property, plant and equipment	(104,883,783)	(295,314,351)	(46,519,384)
Purchases of intangible assets	—	(3,617,607)	(569,863)
<b>Net cash used in investing activities</b>	<b>(104,238,941)</b>	<b>(298,923,958)</b>	<b>(47,087,987)</b>
<b>Cash flows from financing activities:</b>			
Proceeds from issuance of mezzanine equity	729,412,999	—	—
Shareholders' contribution	1,589,236	—	—
Proceeds from bank loans and other borrowings	32,253,609	414,116,587	65,233,702
Repayment of bank loans and other borrowings	(160,407,571)	(49,558,442)	(7,806,692)
Proceeds from borrowings from related parties	299,757,219	—	—
Repayment of borrowings from related parties	(163,346,796)	—	—
<b>Net cash provided by financing activities</b>	<b>739,258,696</b>	<b>364,558,145</b>	<b>57,427,010</b>
Effect of foreign exchange rate on cash	(2,674)	(11,478,411)	(1,808,136)
<b>Net increase (decrease) in cash</b>	<b>388,406,644</b>	<b>(119,389,581)</b>	<b>(18,806,840)</b>
<b>Cash at the beginning of the year</b>	<b>2,050,440</b>	<b>390,457,084</b>	<b>61,506,740</b>
<b>Cash at the end of the year</b>	<b>390,457,084</b>	<b>271,067,503</b>	<b>\$ 42,699,900</b>
<b>Supplemental disclosures of cash flow information:</b>			
Income taxes paid	34,105,055	—	\$ —
Interest paid	8,124,572	2,404,357	\$ 378,746
<b>Non-cash transactions:</b>			
Accretion to redemption value of convertible redeemable preferred shares	16,610,297	130,662,326	\$ 20,582,579
Operating right-of-use assets recognized for related operating lease liabilities	15,048,446	1,516,478	\$ 238,883
Forgiveness of amounts due to related parties	446,092,527	—	\$ —

The accompanying notes are an integral part of these consolidated financial statements.

**YISHENGBIO CO., LTD AND SUBSIDIARIES**  
**NOTES TO THE CONSOLIDATED FINANCIAL STATEMENTS**  
**March 31, 2021 and 2022**

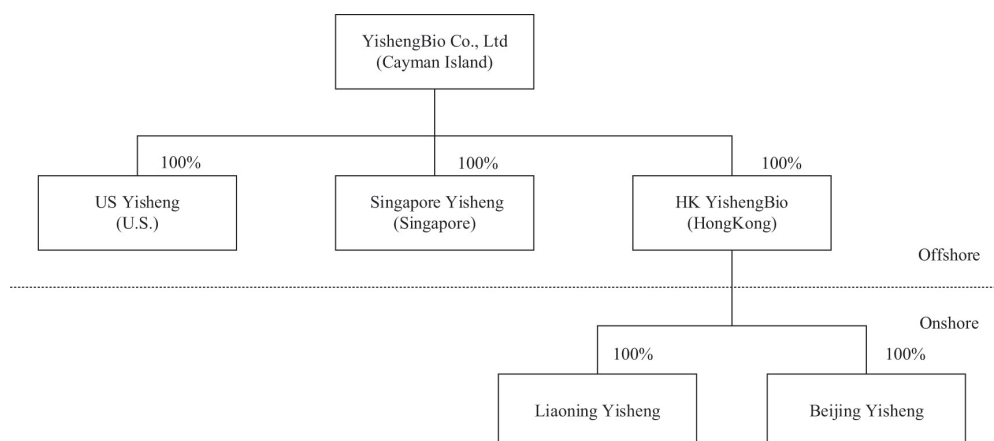
**NOTE 1 — ORGANIZATION AND BUSINESS DESCRIPTION**

YishengBio Co., Ltd (“YS Biopharma”) was incorporated under the laws of Cayman Islands as an exempted company with limited liability in November 2020. It owns three companies and their subsidiaries that were incorporated in the United States of America (“US”), Singapore, Hong Kong and the People’s Republic of China (“China” or the “PRC”) (collectively, the “Company” or “YS Group”). YS Group is principally engaged in the research, development, manufacturing and sale of vaccines and therapeutic biologics. It developed a PIKA immunomodulating technology platform and a series of product candidates targeting rabies, hepatitis B, influenza and other indications. It is also conducting the production and sale of YSJA™ (依生君安™) rabies vaccine, the first aluminum-free lyophilized rabies vaccine that was launched in China.

Prior to the business reorganization that was completed in February 2021, YS Group conducted its business under Yisheng Biopharma Co., Ltd (“Yisheng Biopharma”), a Cayman Islands company established in April 2010, as an offshore holding company used by its shareholders to hold and control its business operation. Before or after the reorganization, both YS Biopharma and Yisheng Biopharma are controlled by the same major shareholder, Zhang Yi, founder and chairman of YS Group and Yisheng Biopharma.

In February 2021, YS Group’s business and technology segments were separated and spun-off from the parent company of Yisheng Biopharma Co., Ltd. by way of a series of corporate and business restructuring. In connection with such restructuring, YishengBio (Hong Kong) Holdings Limited (“HK YishengBio”) and Beijing Yisheng Biotechnology Co., Ltd. (“Beijing Yisheng”) were established under the laws of Hong Kong in December 2020 and the PRC in February 2021, respectively. In January 2021 and February 2021, Liaoning Yisheng Bio-Pharma Co., Ltd. (“Liaoning Yisheng”) and Beijing Yisheng became wholly-owned subsidiaries of HK YishengBio. In December 2020, YS Biopharma issued shares and entered into shareholders agreement with the then shareholders of Yisheng Biopharma to substantially mirror their respective interests in Yisheng Biopharma to YS Biopharma. In January 2021, YS Biopharma acquired all the equity interests of Yisheng US Biopharma Inc. (“US Yisheng”) and Yisheng Biopharma (Singapore) Pte. Ltd. (“Singapore Yisheng”) from Yisheng Biopharma, both of which became wholly-owned subsidiaries of YS Biopharma. In February 2021, Beijing Yisheng acquired all the relevant assets and business from a subsidiary of Yisheng Biopharma. The restructuring was completed in February 2021. After the reorganization, there is no equity relationship, no business activities and no business relevance or competition between Yisheng Biopharma and YS Biopharma, and both are controlled by the same shareholder, Zhang Yi.

YS Group’s current legal entity structure is as follows:



As of the date of this report, YS Group is consisted of the following legal entities:

<u>Legal Entity</u>	<u>Nature of Operations</u>	<u>Date of Incorporation</u>	<u>Place of Incorporation</u>
YishengBio Co., Ltd ("YS Biopharma")	Holding Company	November 16, 2020	Cayman Islands
YishengBio (Hong Kong) Holdings Limited ("HK YishengBio")	Holding Company	December 28, 2020	Hong Kong
Yisheng Biopharma (Singapore) Pte. Ltd. ("Singapore Yisheng")*	Research and development of vaccines and therapeutic biologics	November 28, 2009	Singapore
Yisheng US Biopharma Inc. ("US Yisheng")	Research of vaccines and therapeutic biologics	September 29, 2009	US
Liaoning Yisheng Bio-Pharma Co., Ltd. ("Liaoning Yisheng")**	Research and development, manufacturing and commercialization of vaccines and therapeutic biologics	May 26, 1994	PRC
Beijing Yisheng Biotechnology Co., Ltd. ("Beijing Yisheng")	Research and development of vaccines and therapeutic biologics	February 4, 2021	PRC

\* Singapore Yisheng was incorporated November 28, 2009, and acquired by YS Group in fiscal 2011.

\*\* Liaoning Yisheng was incorporated May 26, 1994, and acquired by YS Group in fiscal 2005.

## NOTE 2—LIQUIDITY

As reflected in the accompanying consolidated financial statements ("CFS"), the Company reported net loss of RMB106,004,401 and RMB191,826,242 for the fiscal years ended March 31, 2022 and 2021, respectively. Cash used in operating activities was RMB173,545,357 for the fiscal year ended March 31, 2022.

In assessing its liquidity, management monitors and analyzes the Company's cash, its ability to generate sufficient revenue sources in the future, and its operating and capital expenditure commitments. As of March 31, 2022, the Company had cash of approximately RMB271.07 million (US\$42.7 million). As of March 31, 2022, the Company had outstanding bank loans and other borrowing of approximately RMB365.66 million (US\$57.6 million) from various financial institutions.

Currently, the Company is working to improve its liquidity and capital sources primarily through cash flows from operations, debt and equity financing. Based on the Company current operating plan, management believes the above-mentioned measures collectively will provide sufficient liquidity for YS Group to meet its future liquidity and capital requirement for at least 12 months from the date of this report.

## NOTE 3—SUMMARY OF SIGNIFICANT ACCOUNTING POLICIES

### *Basis of Presentation*

These CFS and related notes of YS Group were prepared in accordance with accounting principles generally accepted in the United States of America ("GAAP") and the rules and regulations of the U.S. Securities and Exchange Commission ("SEC"). In the opinion of management, all adjustments necessary to present fairly in all material respects the financial position, results of operations and cash flows for all periods presented were made.

### *Basis of Consolidation*

The CFS include the financial statements of YS Group and its wholly-owned subsidiaries. All significant intercompany transactions and balances were eliminated upon consolidation. The CFS were prepared on a historical cost basis, except for financial assets and financial liabilities which have been measured at fair value.

The functional currency of YS Group and its Hong Kong subsidiary, US subsidiary is the United States dollars (“US\$”). The functional currency of YS Group’s Singapore subsidiary is the Singapore dollars (“S\$”). The functional currency of YS Group’s PRC subsidiaries is the Chinese Renminbi (“RMB”). The determination of functional currency is based on the criteria of Accounting Standard Codifications (“ASC”) as promulgated by the Financial Accounting Standards Board, ASC 830, Foreign Currency Matters (“ASC 830”). YS Group uses the RMB as its reporting currency.

The business reorganization as described in Note 1 was treated as a recapitalization of entities under common control and the accompanying CFS of YS Group give retroactive effect to this transaction.

#### *Use of Estimates*

The preparation of the CFS in conformity with GAAP requires management to make estimates and assumptions that affect the reported amounts of assets and liabilities and disclosure of contingent assets and liabilities at the date of the CFS and the reported amounts of revenues and expenses during the reporting periods. Significant estimates and assumptions reflected in these CFS include, but are not limited to, the valuation of YS Group’s convertible redeemable preferred shares and ordinary shares, accrual of stock-based compensation expense, allowance for doubtful accounts and obsolete inventories, useful life of property, plant and equipment, income taxes and uncertain tax positions. Actual amounts could differ from those estimates. Changes in estimates are recorded in the period in which they become known. Due to the risks and uncertainties involved in YS Group’s business and evolving market conditions and, given the subjective element of the estimates and assumptions made, actual results may differ from estimated results.

#### *Foreign Currency Translation*

YS Group’s CFS are reported using the RMB. The results of operations and the consolidated statements of cash flows denominated in foreign currency are translated at the average rate of exchange during the reporting period. Assets and liabilities denominated in foreign currencies at the balance sheet date are translated at the applicable rates of exchange in effect at that date. The equity denominated in the functional currency is translated at the historical rate of exchange at the time of capital transaction. Because cash flows are translated based on the average translation rate, amounts related to assets and liabilities reported on the consolidated statements of cash flows will not necessarily agree with changes in the corresponding balances on the consolidated balance sheets. Foreign currency translation adjustments arising from the use of different exchange rates from period to period are included as a separate component of accumulated other comprehensive income included in YS Group’s consolidated statements of changes in shareholders’ deficit. Gains and losses from foreign currency transactions are included in YS Group’s consolidated statements of operations and comprehensive loss.

The value of RMB against US\$ and other currencies may fluctuate and is affected by, among other things, changes in the PRC’s political and economic conditions. The following table outlines the currency exchange rates used in preparing YS Group’s CFS:

	As of March 31,		For the Years Ended March 31,	
	2022	2021	2022	2021
Foreign currency	Balance Sheet	Balance Sheet	Profit/Loss	Profit/Loss
<b>RMB:1US\$</b>	6.3482	6.5713	6.4598	6.8282
<b>RMB:1S\$</b>	4.6932	4.8768	4.7850	4.9246

#### *Convenience translation*

Amounts in US\$ are presented for the convenience of the reader and translated at US\$1.00 to RMB 6.3482, representing the central parity rate release of the People’s Bank of China on March 31, 2022. No representation is made that the RMB amounts could have been, or converted, realized or settled into US\$ at such rate.

#### *Cash*

Cash includes cash on hand and demand deposits in accounts maintained with commercial banks. YS Group maintains bank accounts in China. Cash balances in bank accounts in China are not insured by the Federal Deposit Insurance Corporation or other programs.

***Accounts Receivable, net***

Accounts receivable are presented net of allowance for doubtful accounts. YS Group reduces its accounts receivable by recording a bad debt allowance to account for the estimated impact of collection issues resulting from a client's inability or unwillingness to pay valid obligations to YS Group. YS Group determines the adequacy of allowance for doubtful accounts based on individual account analysis, historical collection trend, and best estimate of specific losses on individual exposures. YS Group establishes an allowance for doubtful accounts when there is objective evidence that YS Group may not be able to collect amounts due.

Accounts receivable balances are written off after all collection efforts have been exhausted.

***Advance to Suppliers***

Advance to suppliers represent amounts advanced to vendors or suppliers for providing raw materials to YS Group. The suppliers usually require advance payments when YS Group orders materials and the advance will be utilized to offset YS Group's actual payment obligations. These amounts advanced are unsecured, non-interest bearing and generally short term in nature. YS Group will reduce its advance to suppliers by recording an allowance that approximates the extent of the advance that may not be realizable during the procurement process. YS Group did not record any allowance against its advance to suppliers as of March 31, 2022, 2021.

***Inventories, net***

Inventories are stated at the lower of cost or net realizable value. Cost is determined on the weighted average basis and comprises all cost of purchase and other costs incurred in bringing the inventories to their present location and condition. Net realizable value is based on estimated selling prices less any estimated costs to be incurred to completion and disposal.

YS Group reviews the carrying amounts of the inventories on a quarterly basis to determine whether the inventories are carried at lower of carrying amount or net realizable value. The net realizable value is estimated based on current market situation and historical experience.

Adjustments are recorded to write down the cost of inventory based on the expiration date of raw materials and the estimate of future usage. Write-downs are recorded in cost of revenue in the consolidated statements of operations and comprehensive loss.

***Property, Plant and Equipment, net***

Property, plant and equipment are stated at cost less accumulated depreciation and any impairment losses. The cost of property, plant and equipment comprises its purchase price and any directly attributable costs of bringing the asset to its working condition and location for its intended use.

Expenditure incurred after items of property, plant and equipment have been put into operation, such as repairs and maintenance, is normally charged to the statement of operations in the period in which it is incurred. In situations where the recognition criteria are satisfied, the expenditure for a major reconstruction is capitalized in the carrying amount of the asset as a replacement. Where significant parts of property, plant and equipment are required to be replaced at intervals, YS Group recognizes such parts as individual assets with specific useful lives and depreciates them accordingly.

Depreciation is calculated on the straight-line basis to reduce the cost of each item of property, plant and equipment to its residual value over its estimated useful life.

<u>Category</u>	<u>Estimated useful life</u>
Plant and building	6 – 20 years
Machinery and equipment	5 – 10 years
Furniture and fixtures	3 – 7 years
Motor vehicle	4 – 5 years
Leasehold improvement	Lesser of the lease term or life of assets

Where parts of an item of property, plant and equipment have different useful lives, the cost of that item is allocated on a reasonable basis among the parts and each part is depreciated separately. Residual values, useful lives and the depreciation method are reviewed, and adjusted if appropriate, at least at each quarter end.

An item of property, plant and equipment including any significant part initially recognized is derecognized upon disposal or when no future economic benefits are expected from its use or disposal. Any gain or loss on disposal or retirement recognized in the statement of operations in the period the asset is derecognized is the difference between the net sales proceeds and the carrying amount of the relevant asset.

#### ***Intangible assets, net***

Intangible assets acquired separately are measured on initial recognition at cost. The cost of intangible assets acquired in a business combination is the fair value at the date of acquisition. The useful lives of intangible assets are assessed to be either finite or indefinite. Intangible assets with finite lives are amortized over the useful economic life and assessed for impairment whenever there is an indication that the intangible asset may be impaired. The amortization period and the amortization method for an intangible asset with a finite useful life is reviewed for appropriateness at each financial year end.

Intangible assets with indefinite useful lives or not yet available for use are tested for impairment annually either individually or at the cash-generating unit level. Such intangible assets, including vaccine license and patent with indefinite useful lives, are not amortized. The useful life of an intangible asset with an indefinite life is reviewed annually to determine whether the indefinite life assessment continues to be supportable. If not, the change in the useful life assessment from indefinite to finite is accounted for on a prospective basis.

Patents with definite useful lives are stated at cost less any impairment losses and are amortized on the straight-line basis over their estimated useful lives of 15 years. Software and laboratory information system are amortized on the straight-line basis over their estimated useful lives of 10 years

An intangible asset that is determined to have an indefinite useful life is not amortized until its useful life is determined to be no longer indefinite. Management evaluates the remaining useful life of an intangible asset that is not being amortized in each reporting period to determine whether events and circumstances continue to support an indefinite useful life. Indefinite-lived intangible assets are subject to impairment testing at least annually

Management believes that YS Group's vaccine registration certificate that was granted by the Liaoning Food and Drug Administration ("FDA") is an intangible asset with an indefinite useful life because the certificate may be renewed indefinitely at little cost and has historically been renewed by Liaoning Yisheng. Liaoning Yisheng intends to renew the certificate indefinitely, and has the ability to do so. Cash flows from the certificate are expected to continue indefinitely. Therefore, the vaccine registration certificate is not amortized until its estimated useful life is believed to be no longer indefinite.

All research and development costs are charged to the statement of operations as incurred. Expenditure incurred on projects to develop new products is capitalized and deferred only when YS Group can demonstrate the technical feasibility of completing the intangible asset so that it will be available for use or sale, its intention to complete and its ability to use or sell the asset, how the asset will generate future economic benefits, the availability of resources to complete the project and the ability to measure reliably the expenditure during the development. Product development expenditure which does not meet these criteria is expensed when incurred.

Land use rights: Prepaid land lease payments represent amounts paid for the rights to use land in the PRC and is recorded net of accumulated amortization. Amortization is provided on a straight-line basis over the term of the lease agreement, which ranges from 48.75 to 50 years.

#### ***Impairment of Long-lived Assets***

YS Group reviews long-lived assets, including definitive-lived intangible assets and property and equipment, for impairment whenever events or changes in circumstances indicate that the carrying amount of an asset may not be recoverable. When such events occur, YS Group assesses the recoverability of the asset group based on the undiscounted future cash flows the asset group is expected to generate and recognizes an impairment loss when estimated undiscounted future cash flows expected to result from the use of the asset



group plus net proceeds expected from disposition of the asset group, if any, is less than the carrying value of the asset group. If YS Group identifies an impairment, YS Group reduces the carrying amount of the asset group to its estimated fair value based on a discounted cash flow approach or, when available and appropriate, to comparable market values and the impairment loss, if any, is recognized in general and administrative expenses in the consolidated statements of operations. YS Group uses estimates and judgments in its impairment tests and if different estimates or judgments had been utilized, the timing or the amount of any impairment charges could be different. Asset groups to be disposed of would be reported at the lower of the carrying amount or fair value less costs to sell, and no longer depreciated. YS Group did not record any impairment charges during the years ended March 31, 2022 and 2021.

#### *Concentrations of Credit Risk and Significant Suppliers*

Financial instruments that potentially subject YS Group to concentration of credit risk consist of cash. YS Group mitigates this risk by maintaining its cash with high quality, accredited financial institutions. As of March 31, 2022, YS Group's cash was deposited at more than two financial institutions and it did not have any foreign currency exchange contracts, option contracts or other hedging arrangements. YS Group has not experienced any losses on its deposits of cash and does not believe that it is exposed to any unusual credit risk beyond the normal credit risk associated with commercial banking relationships.

YS Group's sales are made primarily to Centers for Disease Control and Prevention ("CDCs") located in China. YS Group does not have a concentration of its revenue and accounts receivable with specific customers. As of March 31, 2022 and 2021, there was no customers which accounted for more than 10% of YS Group's accounts receivable balance. During the years ended March 31, 2022 and 2021, there were no customers that accounted for more than 10% of YS Group's net revenues.

Details of percentage of YS Group's top 5 vendors accounting for total purchases are as follows:

	For the Year Ended March 31, 2022		
	(RMB)	(US\$)	
Vendor A	35,172,250	\$ 5,540,508	20.9%
Vendor B	16,227,146	2,556,181	9.6%
Vendor C	9,995,189	1,574,492	\$ 5.9%
Vendor D	7,426,500	1,169,859	4.4%
Vendor E	6,621,300	1,043,020	3.9%
<b>Total</b>	<b>75,442,385</b>	<b>\$11,884,060</b>	<b>44.7%</b>

	For the Year Ended March 31, 2021		
	(RMB)	(US\$)	
Vendor A	32,063,500	\$4,879,324	37.9%
Vendor F	5,781,888	879,870	6.8%
Vendor G	4,862,320	739,933	\$ 5.7%
Vendor C	4,568,088	695,157	5.4%
Vendor H	3,199,200	486,844	3.8%
<b>Total</b>	<b>50,474,996</b>	<b>\$7,681,128</b>	<b>59.6%</b>

Details of percentage of YS Group's top 5 vendors accounting for accounts payable are as follows:

	As of March 31, 2022		
	(RMB)	(US\$)	
Vendor E	1,420,549	\$223,772	4.6%
<b>Total</b>	<b>1,420,549</b>	<b>\$223,772</b>	<b>4.6%</b>

	As of March 31, 2021		
	(RMB)	(US\$)	
Vendor A	1,225,510	\$ 186,494	8.3%
<b>Total</b>	<b>1,225,510</b>	<b>\$ 186,494</b>	<b>8.3%</b>

YS Group's business operation has been, and may continue to be, negatively affected by the outbreak of COVID-19. While many of the restrictions on movements within China have been relaxed, there is great uncertainty around the future of the COVID-19 outbreak and how it will impact YS Group's operations, particularly in terms of the spread of Omicron virus in China.

#### ***Fair Value Measurements***

ASC 825-10 requires certain disclosures regarding the fair value of financial instruments. Fair value is defined as the price that would be received to sell an asset or paid to transfer a liability in an orderly transaction between market participants at the measurement date. A three-level fair value hierarchy prioritizes the inputs used to measure fair value. The hierarchy requires entities to maximize the use of observable inputs and minimize the use of unobservable inputs. The three levels of inputs used to measure fair value are as follows:

- Level 1 — inputs to the valuation methodology are quoted prices (unadjusted) for identical assets or liabilities in active markets.
- Level 2 — inputs to the valuation methodology include quoted prices for similar assets and liabilities in active markets, quoted market prices for identical or similar assets in markets that are not active, inputs other than quoted prices that are observable and inputs derived from or corroborated by observable market data.
- Level 3 — inputs to the valuation methodology are unobservable.

Unless otherwise disclosed, the fair value of YS Group's financial instruments including cash, accounts receivable, advances to suppliers, amounts due from related parties, prepaid expenses and other current assets, short-term bank loans and other loans, accounts payable, and accrued expenses and other current liabilities approximate their recorded values due to their short-term maturities. The fair value of longer-term leases approximates their recorded values as their stated interest rates approximate the rates currently available.

YS Group's non-financial assets, such as property and equipment would be measured at fair value only if they were determined to be impaired.

#### ***Social Security Insurance***

Employees of YS Group's subsidiaries that operate in the PRC are required to participate in a central pension scheme operated by the local municipal government. According to the Social Insurance Law of the PRC (the "Social Security Insurance Law") promulgated by the Standing Committee of the National People's Congress (the "Standing Committee") that became effective on December 29, 2018, there are five basic types of social security insurance, which include basic pension insurance, basic medical insurance, unemployment insurance, work-related injury insurance and maternity insurance (collectively known as "social security insurance"). Both employees and employers make contributions for the first three kinds of the social security insurance; and only employers make contributions for the latter two kinds, which means the employers must pay all or a portion of the social security insurance premiums for their employees. If the YS Group does not fully comply with the relevant requirements and does not make social insurance contributions in full to the social insurance scheme for the employees of PRC affiliated entities, the YS Group will be required to make up the social insurance contributions as well as to pay late fees at the rate of 0.05% per day of the outstanding amount from the due date. If the YS Group fails to make up for the shortfalls within the prescribed time limit, the relevant administrative authorities could impose a fine of one to three times the outstanding amount and file applications to competent courts for compulsory enforcement of payment and deposit. No fine or compulsory enforcement had been imposed by relevant authorities in connection with the delayed payment of the social security insurance premiums by the YS Group. As of March 31, 2022 and 2021, YS Group's recorded late fees of RMB9.5 million and RMB29.4 million, respectively, for its liabilities related to social security insurance

(see Note 10). During the years ended March 31, 2022 and 2021, the YS Group recognized late fees related to social security insurance of approximately, RMB1.9 million and RMB7.7 million, respectively.

### ***Leases***

Under ASC Topic 842, Leases (“ASC 842”), YS Group determines if an arrangement is or contains a lease at inception. For leases with a term of 12 months or less, YS Group does not recognize a right-of-use (“ROU”) asset or lease liability. YS Group’s operating leases are recognized on its consolidated balance sheets as noncurrent assets, current liabilities and noncurrent liabilities. YS Group does not have any finance leases.

ROU assets represent YS Group’s right to use an underlying asset for the lease term and lease liabilities represent YS Group’s obligation to make lease payments arising from the lease. Operating lease ROU assets and liabilities are recognized at the lease commencement date based on the present value of lease payments over the lease term. As YS Group’s leases typically do not provide an implicit rate, YS Group uses an estimate of its incremental borrowing rate based on the information available at the lease commencement date in determining the present value of lease payments. The lease terms may include options to extend or terminate the lease when it is reasonably certain that YS Group will exercise that option. Lease expense is recognized on a straight-line basis over the lease term. For leases with terms greater than 12 months, YS Group records the related asset and lease liability at the present value of lease payments over the lease term. For leases with terms less than 12 months, YS Group records rents in administrative expenses.

### ***Government Grants***

Government grants represent primarily subsidies received from PRC governments for operating a business in their jurisdictions and in compliance with specific policies promoted by the government authorities. YS Group’s PRC-based subsidiaries received specific subsidies and other subsidies from certain local governments. Specific subsidies are subsidies the local government has set certain conditions for the subsidies. Other subsidies are subsidies the local government has not set any conditions and are not tied to future trends or performance of YS Group, receipt of such subsidy is not contingent upon any further actions or performance of YS Group and the amounts do not have to be refunded under any circumstances. Specific subsidies are recorded as deferred government grants upon receipt and are recognized as government grants recognized in income when the conditions are met. Other subsidies are recognized as other income upon receipt as further performance by YS Group is not required.

Government grants for research and development (“R&D”) are recognized as a reduction to R&D expenses when the conditions attached to the grants are met or recognized as government grants recognized in income in the period when the conditions are met after the expenses are incurred. Government grants for property, plant and equipment are deferred and recognized as a reduction to the related depreciation and amortization expenses in the same manner as the property, plant and equipment are depreciated.

### ***Convertible Redeemable Preferred Shares***

YS Group has 2 classes of preferred shares: Series A and Series B with Series A consists of Series A and Series A-1 (collectively, the “Convertible Redeemable Preferred Shares”). These Convertible Redeemable Preferred Shares are considered “probable of becoming redeemable” as one of the redemption events depends solely on the passage of time, and the shares become redeemable following the respective anniversary of the issuance date.

Since the Series A, Series A-1 and Series B Preferred Shares are redeemable at a determinable price on a determinable date, at the option of the holder, or upon occurrence of an event that depends solely on the passage of time, the Series A, they are accounted for as mezzanine equity on the consolidated balance sheets.

The mezzanine equity is carried at the higher of (1) the carrying amount after the attribution of net income of YS Group or (2) the expected redemption value. YS Group accretes the difference between the initial carrying value and the ultimate redemption price using the effective interest rate method from the issuance dates to the earliest possible redemption date.

***Revenue from Contracts with Customers***

YS Group follows ASC 606 — “Revenue from Contracts with Customers” for all periods presented. ASC 606 established principles for reporting information about the nature, amount, timing, and uncertainty of revenue and cash flows arising from its contracts to provide services to customers. Based on the following five steps analysis, revenues from contracts with customers are recognized when control of the promised goods or services is transferred to the customers, in an amount that reflects the consideration YS Group expects to be entitled in exchange for those goods or services.

Step 1: Identify the contract with the customer;

Step 2: Identify the performance obligations in the contract;

Step 3: Determine the transaction price;

Step 4: Allocate the transaction price to the performance obligations in the contract; and

Step 5: Recognize revenue when YS Group satisfies a performance obligation

YS Group is principally engaged in the research, development, manufacturing and sale of vaccines and therapeutic biologics. YS Group’s revenues primarily streams from the sales of vaccines.

The core principle underlying the revenue recognition ASC 606 is that YS Group recognizes revenue to represent the transfer of vaccines to customers in an amount that reflects the consideration to which YS Group expects to be entitled in such exchange. This requires YS Group to identify contractual performance obligations and determine whether revenue should be recognized at a point in time or over time. YS Group’s sales contracts of vaccines have one single performance obligation that is to sell vaccines to the customers. The sales contracts with customers do not involve variable considerations, such as discounts and rebates. And according to the historical operation, circumstance of discounts and rebates have never occurred. The customer pays after acceptance of the vaccines. According to ASC 606, the relevant revenue recognition is based on a point in time of customer acceptance confirmation.

In accordance with ASC606-10-55-36 through 55-40, YS Group evaluates whether it is appropriate to record the gross amount of vaccines and related costs or the net amount earned as commissions. When the entity is a principal, that the entity obtains control of the specified goods or services before they are transferred to the customers, the revenues should be recognized in the gross amount of consideration to which it expects to be entitled in exchange for the specified goods or services transferred. When the entity is an agent and its obligation is to facilitate third parties in fulfilling their performance obligation for specified goods or services, the revenues should be recognized in the net amount for the amount of commission which the entity earns in exchange for arranging for the specified goods or services to be provided by other parties. Revenues are recorded net of value-added taxes. YS Group sells vaccines to the customers, and it obtains control of the vaccines before customer acceptance confirmation. Therefore, YS Group is a principal, and the revenues should be recognized according to the gross method.

***Cost of Revenues***

Cost of revenues consists primarily of the cost of merchandise sold and write-down of slow-moving or obsolete inventories.

***General and Administrative Expenses***

General and administrative expenses consist mainly of payroll and related costs for employees involved in general corporate functions, including accounting, finance, tax, legal and human resources, professional fees, and provision for bad debts, value-added taxes and other general corporate expenses as well as costs associated with the use by these functions of facilities and equipment, such as depreciation and rental expenses.

***Selling Expenses***

Selling expenses consist mainly of payroll and benefits for employees involved in the sales and distribution functions, meeting/event fees, promotion fees, marketing and selling expenses that are related to events and activities at YS Group’s service centers designed to promote product sales as well as operating expenses related to the service centers.

**Research and development expenses**

Research and development expenses include costs directly attributable to the conduct of research and development projects, primarily consist of salaries and other employee benefits, testing and clinical trial expenses, consulting service fees, depreciation and amortization, and office and leasing expenses. All costs associated with research and development are expensed as incurred.

**Other Income (Expenses), net**

Other income (expenses) consists of miscellaneous income and expenses not directly related to YS Group's core business operations. Other income primarily consists of recovery of previously written-off accounts receivable, and write-off of payment obligations that are either more than three years old or no longer justifiable. Other expenses primarily consist of late fees related to YS Group's income tax and social security insurance payment obligations, charitable donation, medical waste disposal fee and financial expenses.

From December 2013 to June 2019, because YS Group was undergoing the construction and certification process of new manufacturing plant, YS Group didn't produce and market its rabies vaccine and did not pay any income taxes nor social security insurance for its employees. During the fiscal year ended March 31, 2021, YS Group accrued RMB7.7 million of late fees related to its social security insurance and RMB18.7 million of late fees on its tax. During the fiscal year ended March 31, 2022, YS Group accrued RMB1.9 million of late fees related to its social security insurance and RMB0.2 million of late fees related to its tax. During the fiscal years ended March 31, 2022 and 2021, YS Group paid RMB86.2 million and RMB5.0 million of late fees related to on social security insurance and tax, respectively.

**Income Taxes**

**Cayman Islands.** Under the current laws of the Cayman Islands, YS Group is not subject to tax on income or capital gains. In addition, upon payments of dividends by YS Group to its shareholders, no Cayman Islands withholding tax is imposed.

**Hong Kong.** Under the Hong Kong tax laws, Yisheng Hong Kong is exempted from profit tax on its foreign-sourced income and there are no withholding taxes in Hong Kong on remittance of dividends.

**Singapore.** The subsidiary incorporated in Singapore files separate income tax returns in Singapore and paid Singapore statutory income tax of 17%.

**China.** Pursuant to the PRC Corporate Income Tax Law and the respective regulations, subsidiaries operating in China are subject to corporate income tax at a statutory rate of 25% on the taxable income.

**United States.** The subsidiary incorporated in Maryland, United States is subject to statutory United States federal corporate income tax at a rate of 21% and state income tax in Maryland at a rate of 8.25%.

Current tax assets and liabilities are measured at the amount expected to be recovered from or paid to the taxation authorities, based on tax rates (and tax laws) that have been enacted or substantively enacted by the end of the Relevant Periods, taking into consideration interpretations and practices prevailing in the countries in which YS Group operates.

Deferred tax is provided, using the liability method in accordance with ASC740, *Income Taxes* ("ASC 740"), on all temporary differences at the end of each of the Relevant Periods between the tax bases of assets and liabilities and their carrying amounts for financial reporting purposes.

Deferred tax liabilities are recognized for all taxable temporary differences, except:

- when the deferred tax liability arises from the initial recognition of goodwill or an asset or liability in a transaction that is not a business combination and, at the time of the transaction, affects neither the accounting profit nor taxable profit or loss; and
- in respect of taxable temporary differences associated with investments in subsidiaries when the timing of the reversal of the temporary differences can be controlled and it is probable that the temporary differences will not reverse in the foreseeable future.

Deferred tax assets are recognized for all deductible temporary differences, and the carryforward of unused tax credits and any unused tax losses. Deferred tax assets are recognized to the extent that it is probable that taxable profit will be available against which the deductible temporary differences, and the carryforward of unused tax credits and unused tax losses can be utilized, except:

- when the deferred tax asset relating to the deductible temporary differences arises from the initial recognition of an asset or liability in a transaction that is not a business combination and, at the time of the transaction, affects neither the accounting profit nor taxable profit or loss; and
- in respect of deductible temporary differences associated with investments in subsidiaries, deferred tax assets are only recognized to the extent that it is probable that the temporary differences will reverse in the foreseeable future and taxable profit will be available against which the temporary differences can be utilized.

The carrying amount of deferred tax assets is reviewed at the end of each reporting period and reduced to the extent it is no longer probable that sufficient taxable profit will be available to allow all or part of the deferred tax asset to be utilized.

Deferred tax assets and liabilities are measured at the tax rates that are expected to apply to the period when the asset is realized or the liability is settled, based on tax rates (and tax laws) that have been enacted or substantively enacted by the end of the Relevant Periods.

Deferred tax assets and liabilities are offset if and only if YS Group has a legally enforceable right to set off current tax assets and current tax liabilities and the deferred tax assets and deferred tax liabilities relate to income taxes levied by the same taxation authority on either the same taxable entity or different taxable entities which intend either to settle current tax liabilities and assets on a net basis, or to realize the assets and settle the liabilities simultaneously, in each future period in which significant amounts of deferred tax liabilities or assets are expected to be settled or recovered.

YS Group records a valuation allowance to offset deferred tax assets if based on the weight of available evidence, it is more-likely-than-not that some portion, or all, of the deferred tax assets will not be realized. The effect on deferred taxes of a change in tax rate is recognized in tax expense in the period that includes the enactment date of the change in tax rate.

YS Group accounted for uncertainties in income taxes in accordance with ASC 740. Interest and penalties arising from underpayment of income taxes shall be computed in accordance with the related PRC tax law. The amount of interest expense is computed by applying the applicable statutory rate of interest to the difference between the tax position recognized and the amount previously taken or expected to be taken in a tax return. Interest and penalties recognized in accordance with ASC 740 are classified in the consolidated statements of comprehensive loss as non-operating expense.

#### ***Value Added Tax (“VAT”)***

Value-added taxes (“VAT”) collected from customers relating to product sales and remitted to governmental authorities are presented on a net basis. VAT collected from customers is excluded from revenue. The VAT payable is presented in the account of accrued expenses and other liabilities.

#### ***Taxes other than Income Tax***

Under the PRC Tax Law, taxes other than income tax primarily include additional tax calculated based on value-added tax payable, individual income tax, property tax, etc.

#### ***Share-based Compensation***

YS Group operates a share option scheme for the purpose of providing incentives and rewards to eligible participants who contribute to the success of YS Group’s operations. Employees (including directors) of Company receive granted shares and share options in the form of share-based payments, whereby employees render services as consideration for equity instruments (“equity-settled transactions”).

The cost of equity-settled transactions with employees for grants is measured by reference to the fair value of the equity instruments at the date at which they are granted. The fair value is determined by an external valuer

using a binomial model. The cost of equity-settled transactions is recognized in employee benefit expense, together with a corresponding increase in equity, over the period in which the performance and/or service conditions are fulfilled.

The cumulative expense recognized for equity-settled transactions at the end of each of the relevant periods until the vesting date reflects the extent to which the vesting period has expired and YS Group's best estimate of the number of equity instruments that will ultimately vest. The charge or credit to the statement of profit or loss for a period represents the movement in the cumulative expense recognized as at the beginning and end of that period. Service and non-market performance conditions are not taken into account when determining the grant date fair value of awards, but the likelihood of the conditions being met is assessed as part of the YS Group's best estimate of the number of equity instruments that will ultimately vest. Market performance conditions are reflected within the grant date fair value. Any other conditions attached to an award, but without an associated service requirement, are considered to be non-vesting conditions. Non-vesting conditions are reflected in the fair value of an award and lead to an immediate expensing of an award unless there are also service and/or performance conditions.

For awards that do not ultimately vest because non-market performance and/or service conditions have not been met, no expense is recognized. Where awards include a market or non-vesting condition, the transactions are treated as vesting irrespective of whether the market or non-vesting condition is satisfied, provided that all other performance and/or service conditions are satisfied.

Where the terms of an equity-settled award are modified, as a minimum an expense is recognized as if the terms had not been modified, if the original terms of the award are met. In addition, an expense is recognized for any modification that increases the total fair value of the share-based payments, or is otherwise beneficial to the employee as measured at the date of modification.

Where an equity-settled award is cancelled, it is treated as if it had vested on the date of cancellation, and any expense not yet recognized for the award is recognized immediately. This includes any award where non-vesting conditions within the control of either the YS Group or the employee are not met. However, if a new award is substituted for the cancelled award, and is designated as a replacement award on the date that it is granted, the cancelled and new awards are treated as if they were a modification of the original award, as described in the previous paragraph.

#### ***Comprehensive Loss***

Comprehensive loss consists of two components, net loss and other comprehensive income (loss). Other comprehensive income (loss) consists of foreign currency translation adjustment from YS Group not using RMB as its functional currency.

#### ***Shareholders' Contribution***

Main sources of shareholders' contribution include debt forgiveness from related parties and cash donations from shareholders. In fiscal 2021, YS Group's related parties forgave amounts owed by YS Group that debts amounted to approximately RMB446,092,527. YS Group recorded the forgiveness as an increase in additional paid-in capital. In addition, shareholders donated approximately RMB1,589,200 cash to YS Group as additional paid-in capital in fiscal 2021.

#### ***Loss Per Share***

In accordance with ASC 260, Earnings Per Share, basic loss per share is computed by dividing net loss attributable to ordinary shareholders by the weighted average number of ordinary shares outstanding during the period. Diluted loss per share is calculated by dividing net loss attributable to ordinary shareholders as adjusted for the effect of dilutive ordinary equivalent shares, if any, by the weighted average number of ordinary shares plus dilutive equivalent shares outstanding during the period. Dilutive equivalent shares are excluded from the computation of diluted loss per share if their effects would be anti-dilutive. No potential common shares was included in the computation of diluted loss per share when a loss from continuing operation exists.

***Segment Reporting***

ASC 280, “Segment Reporting”, establishes standards for reporting information about operating segments on a basis consistent with YS Group’s internal organizational structure as well as information about geographical areas, business segments and major customers in the CFS for details on YS Group’s business segments.

YS Group uses the management approach to determine reportable operating segments. The management approach considers the internal organization and reporting used by YS Group’s chief operating decision maker (“CODM”) for making decisions, allocating resources and assessing performance. YS Group’s CODM has been identified as the CEO, who reviews consolidated results when making decisions about allocating resources and assessing performance of YS Group.

Based on management’s assessment, YS Group has only one operating segment, which is the development, production, marketing and sale of biopharmaceutical products. No operating segments were aggregated to form the reportable operating segment.

YS Group’s non-current assets are located in the PRC and other countries. The location of these non-current assets can be aggregated to form the reportable geographical segment.

***Significant Risks****Currency risk*

A majority of YS Group’s expenses are denominated in RMB and a significant portion of YS Group and its subsidiaries’ assets and liabilities are denominated in RMB. RMB is not freely convertible into foreign currencies. In the PRC, certain foreign exchange transactions are required by law to be transacted only by authorized financial institutions at exchange rates set by the People’s Bank of China (“PBOC”). Remittances in currencies other than RMB by YS Group in China must be processed through the PBOC or other Company foreign exchange regulatory bodies which require certain supporting documentation in order to affect the remittance.

YS Group maintains bank accounts in the PRC. On May 1, 2015, China’s new Deposit Insurance Regulation came into effect, pursuant to which banking financial institutions, such as commercial banks, established in the PRC are required to purchase deposit insurance for deposits in RMB and in foreign currency placed with them. Such Deposit Insurance Regulation would not be effective in providing complete protection for YS Group’s accounts, as its aggregate deposits are higher than the compensation limit, which is RMB 500,000 for one bank. However, YS Group believes the risk of failure of any of these Chinese banks is remote. Bank failure is uncommon in the PRC and YS Group believes that those Chinese banks that hold YS Group’s cash are financially sound based on public available information.

*Concentration and political risk*

Currently, all of YS Group’s operations are carried out in the PRC. Accordingly, YS Group’s business, financial condition and results of operations may be influenced by the political, economic and legal environment in the PRC, and by the general state of the PRC’s economy. YS Group’s operations in the PRC are subject to specific considerations and significant risks not typically associated with companies in North America and Western Europe. YS Group’s results may be adversely affected by changes in governmental policies with respect to laws and regulations, anti-inflationary measures, currency conversion and remittance abroad, and rates and methods of taxation, among other things. Although YS Group has not experienced losses from these situations and believes that it is in compliance with existing laws, this may not be indicative of future results.

*Interest rate risk*

Fluctuations in market interest rates may negatively affect YS Group’s financial condition and results of operations. YS Group is exposed to floating interest rate risk on cash deposit and floating rate borrowings, and the risks due to changes in interest rates is not material. YS Group has not used any derivative financial instruments to manage YS Group’s interest risk exposure.



**Related Parties**

A party is considered to be related to YS Group if the party directly or indirectly or through one or more intermediaries, controls, is controlled by, or is under common control with YS Group. Related parties also include principal owners of YS Group, its management, members of the immediate families of principal owners of YS Group and its management and other parties with which YS Group may deal if one party controls or can significantly influence the management or operating policies of the other to an extent that one of the transacting parties might be prevented from fully pursuing its own separate interests. A party which can significantly influence the management or operating policies of the transacting parties or if it has an ownership interest in one of the transacting parties and can significantly influence the other to an extent that one or more of the transacting parties might be prevented from fully pursuing its own separate interests is also a related party.

**Recently Issued Accounting Pronouncements**

In June 2016, the FASB issued Accounting Standards Update (“ASU”) 2016-13, Financial Instruments — Credit Losses (Topic 326). The amendments in this Update require a financial asset (or a group of financial assets) measured at amortized cost basis to be presented at the net amount expected to be collected. The amendments broaden the information that an entity must consider in developing its expected credit loss estimate for assets measured either collectively or individually. The use of forecasted information incorporates more timely information in the estimate of expected credit loss, which will be more decision useful to users of the financial statements. This ASU is effective for annual and interim periods beginning after December 15, 2019 for issuers and December 15, 2020 for non-issuers. Early adoption is permitted for all entities for annual periods beginning after December 15, 2018, and interim periods therein. In May 2019, the FASB issued ASU 2019-05, Financial Instruments — Credit Losses (Topic 326): Targeted Transition Relief. This ASU adds optional transition relief for entities to elect the fair value option for certain financial assets previously measured at amortized cost basis to increase comparability of similar financial assets. The ASUs should be applied through a cumulative-effect adjustment to retained earnings as of the beginning of the first reporting period in which the guidance is effective (that is, a modified retrospective approach). On November 19, 2019, the FASB issued ASU 2019-10 to amend the effective date for ASU 2016-13 to be fiscal years beginning after December 15, 2022 and interim periods therein. YS Group is still evaluating the impact of accounting standard of credit losses on YS Group’s CFS.

In December 2019, the FASB issued ASU 2019-12, Income Taxes (Topic 740): Simplifying the Accounting for Income Taxes, which removes certain exceptions to the general principles in Topic 740, and improves consistent application of and simplify U.S. GAAP for other areas of Topic 740 by clarifying and amending existing guidance. For public business entities, the amendments in this update are effective for fiscal years, and interim periods within those fiscal years, beginning after December 15, 2020. For all other entities, the amendments in this update are effective for fiscal years beginning after December 15, 2021, and interim periods within fiscal years beginning after December 15, 2022. Early adoption of the amendments is permitted. YS Group will adopt this ASU within annual reporting period of March 31, 2023 and expects that the adoption of this ASU will not have a material impact on YS Group’s CFS

YS Group does not believe other recently issued but not yet effective accounting standards, if currently adopted, would have a material effect on YS Group’s consolidated financial position, statements of Income and comprehensive income and cash flows.

**NOTE 4—ACCOUNTS RECEIVABLE, NET**

	As of March 31,		
	2021	2022	2022
	(RMB)	(RMB)	(US\$)
Trade receivables	223,033,688	322,170,980	\$50,749,973
Allowance for doubtful accounts	(8,530,951)	(13,615,875)	(2,144,840)
<b>Accounts receivable, net</b>	<b>214,502,737</b>	<b>308,555,105</b>	<b>\$48,605,133</b>

The allowance for doubtful accounts reflects YS Group's best estimate of probable losses inherent in the accounts receivable balance. YS Group estimates the allowance based on historical experience, the age of the accounts receivable balances, credit quality of YS Group's customers, current and forecasted future economic conditions, and other factors that may affect customers' ability to pay. During the fiscal years ended March 31, 2022 and 2021, YS Group recorded approximately RMB5.1 million and RMB6.4 million bad debt expense, respectively.

YS Group's accounts receivable are not written off in the track period.

Below is an analysis of the movements in the allowance for doubtful account:

	For the Fiscal Year Ended March 31,		
	2021	2022	2022
	(RMB)	(RMB)	(US\$)
Balance at beginning of the year	2,116,317	8,530,951	\$1,343,838
Additions	6,414,634	5,084,924	801,002
<b>Balance at end of the year</b>	<b>8,530,951</b>	<b>13,615,875</b>	<b>\$2,144,840</b>

#### NOTE 5—INVENTORIES, NET

YS Group's inventories consist of the following:

	As of March 31,		
	2021	2022	2022
	(RMB)	(RMB)	(US\$)
Raw materials	20,865,093	57,926,980	\$ 9,124,946
Work in progress	23,453,665	40,795,744	6,426,348
Finished goods	78,422,922	73,285,870	11,544,354
Allowance for slow-moving or obsolete inventories	(41,301,797)	(5,503,029)	(866,864)
<b>Inventories, net</b>	<b>81,439,883</b>	<b>166,505,565</b>	<b>\$26,228,784</b>

The movements in the allowance for slow-moving or obsolete inventories are as follows:

	For the Fiscal Year Ended March 31,		
	2021	2022	2022
	(RMB)	(RMB)	(US\$)
Balance at beginning of the year	76,661,332	41,301,797	\$ 6,506,064
Additions	950,261	4,393,629	692,106
Inventories written off	(36,309,796)	(40,192,397)	(6,331,306)
<b>Balance at end of the year</b>	<b>41,301,797</b>	<b>5,503,029</b>	<b>\$ 866,864</b>

**NOTE 6—PROPERTY, PLANT AND EQUIPMENT, NET**

Property, plant and equipment consist of the following:

	As of March 31,		
	2021 (RMB)	2022 (RMB)	2022 (US\$)
<b>Cost</b>			
Construction in progress	40,158,349	318,000,074	\$ 50,092,951
Plant and buildings	153,845,452	170,206,987	26,811,850
Machinery and equipment	174,933,799	194,875,303	30,697,726
Electronic equipment	8,442,743	10,107,578	1,592,196
Motor vehicles	2,814,066	2,978,155	469,134
Office equipment and furniture	14,241,207	29,888,526	4,708,189
Leasehold improvements	3,889,957	4,390,980	691,689
<b>Total Cost</b>	<b>398,325,573</b>	<b>730,447,603</b>	<b>115,063,735</b>
Less: accumulated depreciation	(132,228,718)	(150,402,597)	(23,692,164)
Less: asset impairment	(29,891,896)	(29,891,896)	(4,708,720)
<b>Property and equipment, net</b>	<b>236,204,959</b>	<b>550,153,110</b>	<b>\$ 86,662,851</b>

In fiscal 2014, based on an evaluation of the company's related production plan and conditions of property, plant and equipment, the company recorded an asset impairment for approximately RMB29.9 million on those property, plant and equipment that could no longer be used for production.

There is no events or changes in circumstances that indicate the carrying amount of an asset may not be fully recoverable by comparing the carrying amount of the assets to the future undiscounted cash flows expected to result from the use of the assets and their eventual disposition.

**NOTE 7—PREPAID EXPENSES AND OTHER CURRENT ASSETS, NET**

	As of March 31,		
	2021 (RMB)	2022 (RMB)	2022 (US\$)
Loan receivable <sup>(1)</sup>	2,966,778	—	\$ —
Deposits <sup>(2)</sup>	1,362,270	2,807,847	442,306
Staff advances <sup>(3)</sup>	290,024	383,251	60,372
Staff's social security <sup>(4)</sup>	190,253	615,581	96,969
Value added tax recoverable <sup>(5)</sup>	148,705	3,442,733	542,316
Other receivable <sup>(6)</sup>	414,898	854,245	134,564
Allowance <sup>(7)</sup>	(115,743)	(115,743)	(18,232)
<b>Total</b>	<b>5,257,185</b>	<b>7,987,914</b>	<b>\$1,258,295</b>

(1) Loan receivable primarily represented a short-term loan arrangement between Yisheng Biopharma Holdings Limited (Hong Kong) and Hong Kong Tang Hillcrest Investment Corporation, which is renewed annually since 2015. Yisheng Biopharma Holdings Limited (Hong Kong) provided an interest free loan of US\$6.3 million to Hong Kong Tang Hillcrest Investment Corporation. As of March 31, 2021, Hong Kong Tang Hillcrest Investment Corporation made repayment of US\$5.9 million in total. As part of reorganization, on December 17, 2020, after the establishment of YishengBio (Hong Kong) Holdings Limited, Yisheng Biopharma Holdings Limited (Hong Kong) transferred such loan receivable to YS Group without any compensation. As of March 31, 2021, the loan receivable denominated in USD is interest free with an outstanding balance of approximately RMB2,967,000 (US\$451,475). As of March 31, 2022, Hong Kong Tang Hillcrest Investment Corporation made full repayment of the loan.

(2) Deposits primarily represented deposits to Centers for Disease Control and Prevention ("CDCs") in connection with participation in the public tender process held by province-level CDCs.

(3) Staff advances primarily represented cash advances paid to employees in advance of their expected business travel or in connection with various expense incurred in the ordinary course of business, such as sales and marketing activities.

- (4) Staff social security primarily represented the portion of the government mandated defined contribution plan that should be made by employees. But this portion should be paid to the government by YS Group on behalf of the employees pursuant to PRC labor regulation. When YS Group pays wages to employees, this portion should be deducted accordingly.
- (5) Value-added taxes (“VAT”) includes input tax on purchase and output tax on sales. VAT collected from customers relating to product sales and remitted to governmental authorities is presented on a net basis, and it is excluded from revenue. YS Group is in a net VAT recoverable position when its input tax on purchase in the current year is greater than the output tax on sales. Such net amount can be deducted in the following years.
- (6) Other receivable primarily consists of prepayment to third parties, such as freight, water and electricity, and promotion fees.
- (7) The allowance reflects YS Group’s best estimate of probable amounts not fully recoverable from the other receivables balance. Due to the fact that some employees resigned and lost contact, the cash paid to them in advance of their expected business travel or in connection with various expense incurred in the ordinary course of business might not be recovered.

#### NOTE 8—INTANGIBLE ASSETS, NET

YS Group’s intangible assets are presented below:

	As of March 31,		
	2021	2022	2022
	(RMB)	(RMB)	(US\$)
<b>Cost</b>			
Patents	79,608,000	79,608,000	\$ 12,540,248
Licenses, software and laboratory information system	2,526,272	6,143,880	967,814
Land use rights	67,181,860	67,181,860	10,582,820
<b>Total Cost</b>	<b>149,316,132</b>	<b>152,933,740</b>	<b>24,090,882</b>
<b>Less: Accumulated Amortization</b>	<b>(65,537,529)</b>	<b>(72,215,762)</b>	<b>(11,375,785)</b>
<b>Intangible Assets, net</b>	<b>83,778,603</b>	<b>80,717,978</b>	<b>\$ 12,715,097</b>

#### NOTE 9—BANK LOANS AND OTHER BORROWINGS

	As of March 31,			Maturity Date	Interest Rate
	2021	2022	2022		
	(RMB)	(RMB)	(US\$)		
China Guangfa Bank Co., Ltd. – Shenyang Branch <sup>(1)</sup>	—	46,456,142	7,318,002	2022/9/16 – 2022/12/16	5.66%
Shanghai Pudong Development Bank Co., Ltd. Shenyang Branch <sup>(2)</sup>	—	64,647,870	10,183,654	2022/7/19 – 2022/12/1	5.30%
Citi Bank <sup>(3)</sup>	—	234,743	36,978	2022/5/1	1.00%
R-Bridge Healthcare Fund, LP <sup>(4)</sup>	—	394,999	62,222	2026/9/15	4.00%
<b>Bank loans due within one year</b>	<b>—</b>	<b>111,733,754</b>	<b>17,600,856</b>		
Citi Bank <sup>(3)</sup>	1,103,609	—	—	2022/5/1	1.00%
R-Bridge Healthcare Fund, LP <sup>(4)</sup>	—	253,928,000	40,000,000	2026/9/15	4.00%
<b>Long-term bank loans</b>	<b>1,103,609</b>	<b>253,928,000</b>	<b>40,000,000</b>		
<b>Total bank loans</b>	<b>1,103,609</b>	<b>365,661,754</b>	<b>57,600,856</b>		

- (1) On September 13, 2021, YS Group entered into a credit facility of RMB 100 million with China Guangfa Bank Co., Ltd. Shenyang Branch for three years to finance its working capital requirements. YS Group drew RMB 46.5 million in total from September 22, 2021 to March 10, 2022 with an annual interest at 5.655%, which is due from September 16, 2022 to December 16, 2022.
- (2) On July 12, 2021, YS Group entered into a credit facility of RMB 140 million with Shanghai Pudong Development Bank Co., Ltd. Shenyang Branch for three years to finance its working capital requirements. YS Group drew down RMB 64.6 million from July 20, 2021 to March 22, 2022 with an annual interest at 5.3%.
- (3) On May 2, 2020, YS Group borrowed RMB1,103,609 (US\$166,400) with an interest at 1.00% from Citi Bank. The loan was due on May 1, 2022. Before March 31, 2022, YS Group repaid approximately RMB 869,000 (US\$129,422). As of March 31, 2022, the balance of approximately RMB235,000 (US\$36,978) was outstanding, which amount was repaid in full in May, 2022.
- (4) On March 16, 2022, YS Group entered into a facility agreement with R-Bridge Healthcare Fund, LP, as agent, to finance RMB

253,928,000 (US\$40,000,000) for 54 months with an annual interest at 4%. YS Group shall repay the loan in instalments by repaying on each Repayment Date which means the fifth business day after each financial quarter date an amount equal to the relevant percentage of the aggregate outstanding principal amount of the loan as at the end of the Availability Period as set out in the table below:

Repayment Date	Repayment Instalment
April 7, 2025	US\$ 6,400,000
July 7, 2025	6,400,000
October 7, 2025	6,400,000
January 7, 2026	6,400,000
April 7, 2026	6,400,000
July 7, 2026	8,000,000
<b>Total</b>	<b><u>US\$40,000,000</u></b>

Under the terms of the Facility Agreement, YS Group and Agent are also entering into a Deed, pursuant to which YS Group will pay to Agent, the Royalties on the Products as contingent interest in addition to the payments made to Agent under the Facility Agreement, on the terms and subject to the conditions of the Deed. YS Group is obliged to pay royalties to such agent as contingent interest for the facility based upon YS Group's annual net sales of rabies vaccines by multiplying the royalty rate ranging from 1.5% to 3.5% by the corresponding amount incremental net sales for that financial year.

YS Group shall pay accrued interest on the Loan on each Payment Date. As of March 31, 2022, YS Group accrued approximately RMB395,000 (US\$62,222) of interest.

In addition, on March 5, 2021, YS Group entered into a credit facility of RMB 250 million with China CITIC Bank for three years to finance its working capital requirements. On September 7, 2021, YS Group entered into another credit facility of RMB 250 million with China CITIC Bank for three years to finance its working capital requirements. YS Group has not drawn any amounts from these two facilities as of date of this report. These two credit facilities are due to expire on March 4, 2024 and September 6, 2024, respectively.

YS Group recorded RMB 2.8 million and RMB 5.8million of interest expense for the years ended March 31, 2022 and 2021, respectively.

#### NOTE 10 — LEASES

A summary of YS Group's operating leases as of March 31, 2022 and 2021 is as follows:

	As of March 31,		
	2021 (RMB)	2022 (RMB)	2022 (US\$)
Operating lease ROU assets	17,245,924	14,850,283	\$2,339,290
Operating lease liabilities – current	3,785,642	4,322,252	680,863
Operating lease liabilities – non-current	13,550,359	10,605,260	\$1,670,593
Weighted average remaining lease term	4.4	3.4	3.4
Weighted average discount rate	5.0%	4.8%	4.8%

A summary of lease cost recognized in YS Group's CFS and supplemental cash flow information related to operating leases is as follows:

	For the Years Ended March 31,		
	2021 (RMB)	2022 (RMB)	2022 (US\$)
Operating lease cost	2,643,917	4,594,967	\$723,822
Cash paid for operating leases	2,601,625	4,587,894	\$722,708

A summary of maturity of operating lease liabilities under the YS Group's non-cancelable operating leases as of March 31, 2022 is as follows:

Fiscal Year Ending March 31,	As of March 31, 2022	
	(RMB)	(US\$)
2023	4,947,481	\$ 779,352
2024	4,837,260	761,989
2025	4,922,251	775,377
2026	1,479,661	233,084
2027 and thereafter	—	—
<b>Total lease payments</b>	<b>16,186,653</b>	<b>2,549,802</b>
Less: Interest	(1,259,141)	(198,346)
<b>Present value of operating lease liabilities</b>	<b>14,927,512</b>	<b>\$2,351,456</b>

#### NOTE 11 — ACCRUED EXPENSES AND OTHER CURRENT LIABILITIES

Accrued expenses and other current liabilities are consisted of the following:

	As of March 31,		
	2021	2022	2022
	(RMB)	(RMB)	(US\$)
Salaries and social security insurance payable <sup>(1)</sup>	86,818,418	57,459,273	\$ 9,051,270
Promotion service fee <sup>(2)</sup>	58,358,838	64,883,477	10,220,768
Taxes other than income tax	1,615,475	1,171,381	184,522
Late fees <sup>(3)</sup>	93,890,390	9,499,595	1,496,423
Payable for property, plant and equipment	4,730,933	48,774,134	7,683,144
CDC transportation and storage fee	12,087,830	35,023,095	5,517,012
Guarantee deposits <sup>(4)</sup>	48,732,986	94,528,659	14,890,624
Professional service fee <sup>(5)</sup>	8,694,317	7,758,448	1,222,149
Other payable <sup>(6)</sup>	7,821,284	7,653,291	1,205,584
<b>Total</b>	<b>322,750,471</b>	<b>326,751,353</b>	<b>51,471,496</b>

- (1) This payable includes primarily unpaid salaries and outstanding social security insurance. During the fiscal year ended March 31, 2022, YS Group paid approximately RMB29.4 million to reduce its payable related to salaries, social security insurance. During the period from April 1, 2022 to the date of this report, YS Group paid approximately RMB11.1 million to reduce this payables. Salaries and social security insurance payables are consisted of the following:

	As of March 31,		
	2021	2022	2022
	(RMB)	(RMB)	(US\$)
Salaries	46,263,007	49,020,045	7,721,881
Social security insurance	39,926,173	7,732,161	1,218,008
Union Fee	629,238	707,067	111,381
<b>Total</b>	<b>86,818,418</b>	<b>57,459,273</b>	<b>9,051,270</b>

- (2) Promotion service fee primarily represents fees for the vaccine promotion, including design and implementation of academic activities, and collection of market information.
- (3) Late fees primarily represent late fees related to corporate income tax, taxes other than income tax and social security insurance and housing reserve fund contributions due to the fact that YS Group failed to pay the income tax related to the period from calendar year 2011 to calendar year 2013, taxes other than income tax related to the period from calendar year 2014 to the beginning of calendar year 2021 and social security insurance related to the period from calendar year 2015 to the beginning of calendar year 2021. As of June, 2021, YS Group has fully paid the unpaid taxes, including income tax and other taxes other than income tax, as well as the late fees charge of them. In fiscal year 2022, the late fee is incurred from unpaid social insurance. The late fees consisted of the following:

	As of March 31,		
	2021	2022	2022
	(RMB)	(RMB)	(US\$)
Late fee charge of income tax	53,890,577	—	—
Late fee charge of taxes other than income tax	10,635,413	—	—
Late fee charge of social insurance	29,364,400	9,499,595	1,496,423
<b>Total</b>	<b>93,890,390</b>	<b>9,499,595</b>	<b>1,496,423</b>

- (4) Guarantee deposits primarily represented refundable deposits paid to YS Group by external service providers as a measurement to guarantee us that external service providers will provide us with high quality and reasonable professional services. The external service providers' professional service scope includes conducting market research and analysis, monitoring product clinical information, collecting and reporting adverse events of the product use, providing academic visits and education seminars, assisting product shipment and payment collections. Their services doesn't assume inventory risk for the vaccines before they are transferred to the end customers.
- (5) Professional service fees primarily represented service fees from consultants and other advisors.
- (6) Other payable primarily represented employees' reimbursement and value added tax.

## NOTE 12 — CONVERTIBLE NOTES

In July 2020, YS Biopharma raised RMB127.0 million (US\$20 million) by way of issuance of convertible notes (the "Convertible Notes") to (i) Adjuvant Global Health Technology Fund, L.P., and Adjuvant Global Health Technology Fund DE, L.P., both of which are affiliates of Adjuvant Capital L.P. (collectively, "Adjuvant") and (ii) OrbiMed New Horizons Master Fund, L.P. (the "ONH"), OrbiMed Genesis Master Fund, L.P. (the "Genesis") and the Biotech Growth Trust PLC (the "BIOG"), all of which are affiliates of OrbiMed Advisors LLC. As part of the Reorganization as described in Note 1 and based on arm's length negotiation between the holders of the Convertible Notes and YS Group, all the Convertible Notes were assigned to YS Group in January 2021.

In January 2021, the principal amount of Convertible Notes together with the accrued interest of US\$ 20,389,315 were converted into 18,393,610 Series B Preferred Shares at US\$1.1085 per share, and the Convertible Note holders also exercised their call option rights under the Convertible Notes and subscribed for 9,660,324 Series B Preferred shares at US\$2.0703 per share.

## NOTE 13 — CONVERTIBLE REDEEMABLE PREFERRED SHARES

YS Group has two classes of preferred shares: Series A and Series B (collectively, the "Convertible Redeemable Preferred Shares") with Series A consists of Series A and A-1. These Convertible Redeemable Preferred Shares are classified outside of the shareholders' equity section of YS Group's consolidated balance sheets because these shares contain deemed liquidation rights that are a contingent redemption feature not solely within the control of YS Group.

### *Series A*

On December 10, 2012, pursuant to the Series A redeemable convertible preferred share purchase agreement and shareholders agreement ("Preferred Shares Agreements"), YS Biopharma issued 21,548,589 Series A redeemable convertible preferred shares ("Series A Preferred Share") to Asia Ventures II L.P., and Beacon Bioventures Fund III Limited Partnership (renamed as "F-Prime Capital Partners Healthcare Fund III LP" on December 30, 2015), collectively with any of their respective affiliates who holds Series A Preferred Shares, at US\$0.93 per share for total cash consideration of US \$20,000,000, of which 6,014,313 shares of Series A were transferred as Series A-1 on September 4, 2020.

### *Series A-1*

On September 4, 2020, pursuant to the share purchase agreement entered into by and among Asia Ventures II L.P., ("Asia Ventures"), F-Prime Capital Partners Healthcare Fund III LP("F-Prime") and Haitong XuYu International Limited, Epiphron Capital (Hong Kong) Limited, 3W Global Investment Limited, OrbiMed New Horizons Master Fund, L.P. and HH SUM XXXVI Holdings Limited (collectively "Purchasers"), Asia

Ventures and F-Prime transferred 6,014,313 Series A Preferred Shares to the Purchasers. As of March 31, 2022, 15,534,276 shares Series A and 6,014,313 shares Series A-1 were issued and outstanding.

### Series B

In January 2021, the principal amount of Convertible Notes (see Note 12) together with the accrued interest of US \$20,389,315 were converted into 18,393,610 Series B Preferred Shares at US \$1.1085 per share, and the convertible note holders also exercised their call option rights under the Convertible Notes and converted into 9,660,324 Series B preferred shares at US \$2.0703 per share.

In January 2021, YS Group raised US \$88,000,000 by way of issuance of 36,129,245 Series B Preferred Shares to Oceanpine Investment Fund II LP, AIHC Master Fund, 3W Global Fund (together with 3W Global Investment Limited, the “3W Global”), MSA Growth Fund II, L.P., Epiphron Capital (Hong Kong) Limited, Wudaokou Capital Limited and Gennex China Growth Fund.

In February 2021, YS Group raised US \$3,000,000 by way of issuance of 1,231,679 Series B Preferred Shares to Superstring Capital Master Fund LP.

The following table summarizes YS Group’s outstanding Convertible Redeemable Preferred Shares as of March 31, 2022:

	Series A		Series A-1		Series B		Total	Total
	Shares	Carrying Value	Shares	Carrying Value	Shares	Carrying Value	Carrying Value	Carrying Value
		(RMB)		(RMB)		(RMB)	(RMB)	(US\$)
<b>As of March 31, 2020</b>	<b>21,548,589</b>	<b>440,585,213</b>	—	—	—	—	<b>440,585,213</b>	<b>\$ 69,403,171</b>
Conversion of convertible notes	—	—	—	—	18,393,610	131,425,527	<b>131,425,527</b>	<b>20,702,802</b>
Call option under convertible notes	—	—	—	—	9,660,324	131,425,290	<b>131,425,290</b>	<b>20,702,765</b>
New insurance	—	—	—	—	37,360,924	597,987,709	<b>597,987,709</b>	<b>94,197,995</b>
Shares transferred	(6,014,313)	(68,232,451)	6,014,313	68,232,451	—	—	—	—
Accretion to redemption value	—	1,758,690	—	—	—	14,851,607	<b>16,610,297</b>	<b>2,616,536</b>
Foreign currency translation adjustment	—	(29,449,559)	—	(2,567,136)	—	(558,770)	<b>(32,575,465)</b>	<b>(5,131,449)</b>
<b>As of March 31, 2021</b>	<b>15,534,276</b>	<b>344,661,893</b>	<b>6,014,313</b>	<b>65,665,315</b>	<b>65,414,858</b>	<b>875,131,363</b>	<b>1,285,458,571</b>	<b>\$202,491,820</b>
Accretion to redemption value	—	57,598,340	—	5,164,090	—	67,899,896	<b>130,662,326</b>	<b>20,582,579</b>
Foreign currency translation adjustment	—	(12,696,574)	—	(2,318,596)	—	(30,884,335)	<b>(45,899,505)</b>	<b>(7,230,318)</b>
<b>As of March 31, 2022</b>	<b>15,534,276</b>	<b>389,563,659</b>	<b>6,014,313</b>	<b>68,510,809</b>	<b>65,414,858</b>	<b>912,146,924</b>	<b>1,370,221,392</b>	<b>\$215,844,081</b>

### Convertible Preferred Stock Rights and Preferences

**Conversion rights:** Each holder of the Preferred Shares has the right, at each holder’s sole discretion, to convert at any time and from time to time, all or any portion of the Preferred Shares into ordinary shares. The initial conversion ratio shall be on a one for one basis, subject to certain general anti-dilution adjustments.

The Preferred Shares will be automatically converted into ordinary shares upon (i) the closing of an initial public offering (IPO) based on the applicable then-effective conversion price or (ii) upon the date specified by written consent or agreement of the holder of the majority of the then outstanding Preferred Shares, voting together as a single class on an as-converted basis.

The initial conversion price and conversion ratio is the stated issuance price of the Preferred Shares and on a one-for-one basis, respectively. The above conversion prices are subject to adjustments in the event that YS Biopharma issues additional ordinary shares or additional deemed ordinary shares through options or convertible instruments for a consideration per share received by YS Biopharma less than the original



respective conversion prices, as the case may be, in effect on the date of and immediately prior to such issue. In such event, the respective conversion price is reduced, concurrently with such issue, to a price as adjusted according to an agreed-upon formula. The above conversion prices are also subject to adjustments on a proportional basis upon other dilution events.

**Voting rights:** Each holder of the Preferred Share is entitled to the number of votes equal to the number of ordinary shares into which such holder's preferred shares could be converted. The holders of the Preferred Shares shall vote together with ordinary shareholders, and not as a separate class or series, on all matters put before the shareholders.

**Liquidation preference:** Upon any liquidation, dissolution or winding up of YS Biopharma, either voluntary or involuntary (a "Liquidation Event"), the assets of YS Biopharma available for distribution shall be distributed in the following order: (i) each Series B Holder shall be entitled to receive, prior and in preference to any distribution of any of the assets of YS Biopharma to the Series A Holders and the Ordinary Holders, an amount per Series B Preferred Share held by such Series B Holder equal to the applicable Original Series B Issue Price plus a single interest at the rate of 8% of the applicable Original Series B Issue Price on an annum basis accumulated from the Original Series B Issue Date to the date such Series B Holder actually receives such repayment, plus all declared and accrued but unpaid dividends on each such Series B Preferred Share (collectively, the "Series B Liquidation Preference"); if the assets available to be distributed among the Series B Holders shall be insufficient to permit the payment to such holders, then the assets of YS Biopharma legally available for distribution shall be all distributed to the Series B Holders that would otherwise be respectively qualified therefor and entitled thereon such Series B Liquidation Preference on a pro rata basis; (ii) after full payment of the Series B Liquidation Preference, each Series A Holder shall be entitled to receive, prior and in preference to any distribution of any of the assets of YS Biopharma to the Ordinary Holders, an amount per Series A Preferred Share held by such Series A Holder equal to the applicable Original Series A Issue Price plus a single interest at the rate of 8% of the applicable Original Series A Issue Price on an annum basis accumulated from the applicable Original Series A Issue Date to the date such Series A Holder actually receives such repayment, plus all declared and accrued but unpaid dividends on each such Series A Preferred Share (collectively, the "Series A Liquidation Preference", together with the Series B Liquidation Preference, the "Liquidation Preference"); if the assets available to be distributed among the Series A Holders shall be insufficient to permit the payment to such holders, then the assets of YS Biopharma legally available for distribution shall be all distributed to the Series A Holders that would otherwise be respectively qualified therefor and entitled thereon such Series A Liquidation Preference on a pro rata basis; (iii) if there are assets of YS Biopharma available for distribution after payment of the Liquidation Preference referred to in clauses (i) and (ii) above, the remaining assets of YS Biopharma available for distribution to the Shareholders shall be distributed ratably among the Ordinary Holders and Preferred Holders on an as-converted basis.

**Dividends:** No dividends, whether in cash, property, or shares of YS Biopharma or otherwise, shall be declared or paid on any other shares during any previous or current fiscal year of YS Biopharma unless and until a dividend in like or greater amount has first been declared or paid on each outstanding Preferred Share (on an as-if-converted basis). All accrued and unpaid dividends, if any shall, to the extent funds are legally available therefor and subject to YS Biopharma being able to pay its debts as they fall due and the value of YS Biopharma's assets exceeding its liabilities immediately after any payment of such dividends, be mandatorily paid upon the earlier to occur of (i) a Liquidation Event, (ii) an optional conversion of Preferred Shares, (iii) an automatic conversion of Preferred Shares and (iv) a redemption of Preferred Shares. No dividends were declared by YS Biopharma's Board of Directors to date.

**Redemption right:** The Preferred Shares are redeemable at the option of the holders for all or any less portion of the Preferred Shares as provided herein at any time following:

- The issuance date when YS Biopharma and its subsidiaries or any ordinary share holder has material default or breach of the Preferred Shares Agreements in terms of its representation, warranties, covenants and obligations and if such breach remains uncured for 30 days after holders of the Preferred Shares give a written request to YS Group; or
- the third (3rd) anniversary of the Original Series B Issue Date, if a Qualified IPO is not achieved; In respect of the Series A Preferred Shares held by Asia Ventures and F-Prime, provided however that during the eighteen (18) months period after January 28, 2021, Asia Ventures and F-Prime shall not exercise its

redemption rights pursuant to that if YS Group is still actively preparing for a Qualified IPO; In respect of the Series A Preferred Shares held by the Series A-1 Holders, at any time following the third (3rd) anniversary of January 28, 2021, if a Qualified IPO is not achieved; or

- When Mr. Zhang, the Chairman of YS Biopharma ceases to be employed or provide service to YS Biopharma.

Since the Series A, Series A-1 and Series B Convertible Redeemable Preferred Shares are redeemable at a determinable price on a determinable date, at the option of the holder, or upon occurrence of an event that depends solely on the passage of time, these Convertible Redeemable Preferred Shares are accounted for as mezzanine equity on the consolidated balance sheets.

The mezzanine equity is carried at the higher of (1) the carrying amount after the attribution of net income of YS Group or (2) the expected redemption value. YS Group accretes for the difference between the initial carrying value and the ultimate redemption price using the effective interest rate method (17% annual compound interest for Series A, 8% annual compound interest for Series A-1 and Series B) from the issuance dates to the earliest possible redemption date.

#### **NOTE 14—STOCK-BASED COMPENSATION**

YS Group operates a share-based payment scheme (the “Scheme”) for the purpose of providing incentives and rewards to eligible participants who contribute to the success of YS Group’s operations. Eligible participants of the Scheme include YS Group’s directors, employees and consultants.

##### ***The 2010 Share Incentive Plan***

On June 21, 2010, YS Group adopted the 2010 Share Incentive Plan (the “Plan”) that has a contractual term of 10 years. The Plan provides for the granting of stock options and other stock-based awards to employees and directors. YS Group’s Board of Directors authorized and reserved for the issuance of up to 10,902,600 ordinary shares under the Plan for the period from 2010 to 2013. Starting from 1 January 2014, the maximum number of shares subject to awards that may be granted during any single calendar year is equal to 1.5% of total issued and outstanding shares as of the first business day of that calendar year.

The stock options granted to employees are accounted for as equity awards and measured at their grant date fair values. Options that vest based on service conditions generally will become vested over a three-year period in equal quarterly instalments of 0.08% each on the last day of every quarter that has elapsed until the options are 100% vested.

On January 1, 2015, an annual grant of 510,000 options, which vest based on performance conditions, were granted to various employees. The annual grant was applicable for calendar years 2015, 2016, 2017, 2018, 2019 and 2020, respectively. The options become vested in equal quarterly instalments based on performance targets established on January 1<sup>st</sup> of each calendar year from 2015 to 2020. There are no more grants after December 31, 2020 under the 2010 share incentive plan.

For options granted to YS Group’s senior executives, the grantee can exercise vested options after the commencement date of exercise and before the earlier of: 1) its contractual term (i.e. 10 years after each of its vesting date); or 2) 5 years after the grantee terminates their employment if the vested option has not been exercised.

For options granted to the remaining employees, the grantee can exercise vested options after the commencement date of exercise and before the earlier of: 1) its contractual term (i.e. 10 years after each of its vesting date); or 2) 12 months after the grantee terminates their employment if the vested option has not been exercised.

For those awards, evaluations are made as of each reporting period to assess the likelihood of performance criteria being met. Share-based payment expenses are then adjusted to reflect the revision of original estimates.

The exercise prices and exercise periods of the share options outstanding as at the end of each of the Relevant Periods are as follows:

	<u>Number of share options</u>	<u>Average exercise price per share option</u> (RMB)
At March 31, 2020	11,223,795	3.8807
Granted during the period	10,254,198	8.4631
Forfeited during the period	(298,117)	6.4631
Exercised during the period	(8,103,671)	—
Expired during the period	(62,783)	6.4631
At March 31, 2021	<u>13,013,422</u>	<u>7.3289</u>
Granted during the period	—	—
Forfeited during the period	—	—
Exercised during the period	—	—
Expired during the period	—	—
At March 31, 2022	<u><u>13,013,422</u></u>	<u><u>7.3289</u></u>

The exercise prices and exercise periods of the share options outstanding as at the end of the reporting periods are as follows:

<u>Year ended 31 March 2021 Number of options</u>	<u>Exercise price (RMB)</u>	<u>Exercise period</u>
6,133,005	3.4845	2021 – 2031
2,453,049	6.4631	2021 – 2026
<u>4,427,368</u>	13.1344	2021 – 2026
<u><u>13,013,422</u></u>		

#### ***Bonus incentive plan***

On January 1, 2015, YS Group launched a bonus incentive program that is effective for six years from launch date. The bonus incentive program is divided into two six-month periods each calendar year. The bonus incentive program specifies for each monthly tranche in the six-month period an independent performance condition for a stated period of service (i.e., one month). The bonus amount is determined on a monthly basis at month-end by the human resources department based on a reasonably objective performance criteria that serves as a basis for promotion and other compensation decisions. A fixed conversion price is then applied to the employee's month end bonus to determine the number of ordinary shares to be issued to the employee for each individual month. At the end of each respective six-month period, YS Group finalizes the vested ordinary shares to be issued to the employee.

Based on the above, the employee does not receive a number of ordinary shares with a fair value equal to a predominantly fixed dollar amount on the delivery date. Hence, the ordinary shares granted to employees are accounted for as equity awards. In addition, each monthly tranche should be accounted for as a separate award with its own service inception date, grant-date fair value, and respective requisite service period because the employee's ability to retain (vest in) the award pertaining to the current month is not dependent on service beyond the current month.

#### ***Restricted share units ("RSU")***

On February 1, 2018, YS Group granted 2,770,000 restricted share units to employees under the Plan. The weighted average grant-date fair value of restricted shares units granted was US\$1.81, which was derived from

the fair value of the underlying ordinary shares. 1,620,000 out of the 2,770,000 restricted share units were subject to service conditions vesting in six equal semi-annual instalments over three years or eight equal semi-annual instalments over four years, respectively. As of March 31, 2022, all the granted options are vested, and there were no unrecognized share-based payment expenses related to unvested restricted shares. The remaining 1,150,000 restricted share units will be vested only upon the successful closing of an IPO. Given that this constitutes a performance condition that is not considered probable until the IPO completion date, YS Group will not recognize any compensation expense until an IPO occurs. Upon the IPO completion date, YS Group will immediately recognize expenses associated with these restricted share units.

On July 25, 2018, YS Group granted 1,080,000 units of restricted share units to three independent directors. Starting from the effective date of August 1, 2018, 120,000 RSUs will be awarded to each of the three directors annually, which shall be vested in equal portion of 30,000 units per three months' Director services rendered by each director. For each of the new directors, 20,000 units will be vested for the two-month period starting from August 1, 2018, and the remaining are vested on quarterly basis starting from October 1, 2018 to July 31, 2021. The grant-date fair value of the restricted share units was US\$1.84, which was derived from the fair value of the underlying ordinary shares. As of March 31, 2022, all the granted options are vested and there were no unrecognized share-based payment expenses related to unvested restricted shares.

#### *The 2020 Share Incentive Plan*

On December 31, 2020, YS Group's board of directors adopted the 2020 Share Incentive Plan for the purpose of granting share-based compensation awards to employees, directors and consultants to incentivize their performance and align their interests with YS Group. Pursuant to such plan, YS Group is entitled to grant awards to directors, employees and consultants of YS Group with rights to subscribe for up to 35,000,000 underlying ordinary shares of YS Biopharma. As of the date of this report, (1) 8,373,671 shares as RSU incentive shares were fully vested and issued to the respective directors and employees of YS Group, and (2) 26,626,329 shares are reserved but not issued, among which, options to subscribe for 13,886,187 ordinary shares of YS Biopharma are granted to certain senior management and employees of YS Group but not exercised.

Stock-based compensation expense included in YS Group's consolidated statements of operations and comprehensive loss is as follows:

	For the Fiscal Years Ended March 31,		
	2021	2022	2022
	(RMB)	(RMB)	(US\$)
Research and development expenses	4,200,464	975,171	\$ 153,614
General and administrative expenses	72,501,943	6,789,277	1,069,481
Selling expenses	54,093	—	—
<b>Total stock-based compensation</b>	<b>76,756,500</b>	<b>7,764,448</b>	<b>\$1,223,094</b>

#### **NOTE 15 — RELATED PARTY TRANSACTIONS AND BALANCES**

The following companies are related parties that had balances or transactions with YS Group as of and during the fiscal years ended March 31, 2022 and 2021:

<u>Name of related parties</u>	<u>Relationship with YS Group</u>
Yisheng Biopharma Co., Ltd	An entity controlled by Yi Zhang
Yisheng Biopharma Holdings Ltd.	An entity controlled by Yi Zhang
Kaifeng Yisheng Pan-Asia Technology Co., Ltd	An entity controlled by Yi Zhang
Beijing Yisheng Xingye Technology Co., Ltd.	An entity controlled by Yi Zhang
Changchun Bailong Biotechnology Co., Ltd.	An entity controlled by Yi Zhang
Henan Yisheng Huizhong Health Services Co., Ltd.	An entity controlled by Yi Zhang
Henan Yisheng Biopharma Co., Ltd.	An entity controlled by Yi Zhang

Name of related parties	Relationship with YS Group
Beijing Huaerdun Kangqi Biotechnology Co., Ltd.	An entity controlled by Yi Zhang
Liaoning Yisheng Pan-Asia	An entity controlled by Yi Zhang
Yi Zhang	Chairman of Board of Directors
Hui Shao	Chief Executive Officer
Zhongkai Shi*	Chief Medical Officer
Nan Zhang	Daughter of the Chairman
Xu Zhang	Daughter of the Chairman

\* Zhongkai Shi resigned in September 2021.

#### ***Outstanding balances with related parties***

	As of March 31,		
	2021	2022	2022
	(RMB)	(RMB)	(US\$)
<b>Amounts due from related party:</b>			
Yisheng Biopharma Holding Ltd (Hong Kong)	30,088,833	—	\$ —
	<b>30,088,833</b>	<b>—</b>	<b>\$ —</b>

During the year ended March 31, 2021, Yisheng Biopharma Holding Ltd (Hong Kong) received repayment of RMB30,088,833 (US\$4.6 million) from Hong Kong Tang Hillcrest Investment Corporation on behalf of YS Group. The loan to Hong Kong Tang Hillcrest Investment Corporation is non-interest bearing and is renewed annually since 2015. During the year ended March 31, 2022, Yisheng Biopharma Holding Ltd (Hong Kong) transferred the repayment fully to YS Group.

#### ***Transactions with related parties***

YS Group had the following transactions with related parties, all of which are interest-free during the fiscal years ended March 31, 2022 and 2021:

	For the Years Ended March 31,		
	2021	2022	2022
	(RMB)	(RMB)	(US\$)
<b>Amounts due from related party:</b>			
<b>Yisheng Biopharma Holdings Limited (Hong Kong)</b>			
Receivable collected on behalf of YS Group	30,088,833	2,966,777	\$ 459,412
Repayment to YS Group		33,055,610	\$5,118,732

In fiscal 2021, YS Group lent RMB30,088,833 to Yisheng Biopharma Holdings Limited (Hong Kong) for its operating needs. In fiscal 2022, YS Group lent another RMB2,966,777 to Yisheng Biopharma Holdings Limited (Hong Kong), and Yisheng Biopharma Holdings Limited (Hong Kong) repaid RMB33,055,610 in full to YS Group. As of March 31, 2022, the balance of amount due from Yisheng Biopharma Holdings Limited (Hong Kong) is RMB nil.

From time to time, and prior to the business reorganization that completed in February 2021, YS Group borrowed or lent money to or from the following related parties that were under common control of Yi Zhang for working capital purposes:

#### **Henan Yisheng Biopharma Co., Ltd. (“Henan Yisheng Biopharma”)**

As of March 31, 2020, YS Group owed Henan Yisheng Biopharma was RMB102,868,404. In fiscal year 2021, Henan Yisheng Biopharma lent RMB 213,545,060 to YS Group for its operating needs, and YS Group repaid

RMB147,375,441 to Henan Yisheng Biopharma. Henan Yisheng Biopharma forgave the remaining debts, RMB169,038,024 during the fiscal year ended March 31, 2021.

**Beijing Yisheng Xingye Technology Co., Ltd. (PRC) (“Beijing Yisheng Xingye”)**

As of March 31, 2020, YS Group owned Beijing Yisheng Xingye Technology Co., Ltd. (PRC) RMB204,218,333. In fiscal year 2021, Beijing Yisheng Xingye lent RMB155,014,765 to YS Group for its operating needs, and YS Group repaid RMB47,360,000 to Beijing Yisheng Xingye. Beijing Yisheng Xingye forgave the remaining debts, RMB311,873,098. As of March 31, 2021, the balance of amount due to Beijing Yisheng Xingye was RMB nil. In fiscal year 2022, Beijing Yisheng Xingye lent RMB46,970 to YS Group, and YS Group repaid it in full. As of March 31, 2022, the balance of amount due to Beijing Yisheng Xingye was RMB nil.

**Henan Yisheng Pan-Asia Co., Ltd. (“Henan Yisheng Pan-Asia”)**

As of March 31, 2020, YS Group owed Henan Yisheng Pan-Asia Co., Ltd. RMB8,000. In fiscal 2021, YS Group repaid RMB8,000 in full to Henan Yisheng Pan-Asia.

**Other Related Parties**

As of March 31, 2020, YS Group owed RMB7,792,152 in total to the following individual: Xu Zhang, Hui Shao, Zhongkai Shi, Yi Zhang and Nan Zhang. In fiscal year 2021, these individuals lent RMB445,833 in total to YS Group, and YS Group repaid RMB8,237,985 in full to these individuals.

**Liaoning Yisheng Pan-Asia Co., Ltd. (“Liaoning Yisheng Pan-Asia”)**

As of March 31, 2020, the Liaoning Yisheng Pan-Asia owed YS Group RMB30,780,298. In fiscal 2021, YS Group lent RMB8,423,885 to Liaoning Yisheng Pan-Asia, and Liaoning Yisheng Pan-Asia repaid RMB6,700,388 to YS Group. YS Group forgave the remaining RMB32,503,795. As of March 31, 2021, the amount due from Liaoning Yisheng Pan-Asia was RMB nil.

**Henan Yisheng Huizhong Co., Ltd. (“Henan Yisheng Huizhong”)**

As of March 31, 2020, Henan Yisheng Huizhong owed YS Group RMB1,744,800. In fiscal 2021, YS Group lent RMB570,000 to Henan Yisheng Huizhong. YS Group forgave Henan Yisheng Huizhong’s debts of RMB2,314,800. As of March 31, 2021, the amount due from Henan Yisheng Huizhong was RMB nil.

**Yisheng Biopharma Co., Ltd. (“Yisheng Biopharma”)**

In fiscal 2022, Yisheng Biopharma lent RMB64,880 to YS Group, and YS Group repaid it in full during the same year. As of March 31, 2022, the amount due to Yisheng Biopharma was RMB nil.

**NOTE 16—INCOME TAX**

**Cayman Islands.** Under the current laws of the Cayman Islands, YS Group is not subject to tax on income or capital gains. In addition, upon payments of dividends by YS Group to its shareholders, no Cayman Islands withholding tax is imposed.

**Hong Kong.** Under the Hong Kong tax laws, Yisheng Hong Kong, as a holding company, is exempted from profit tax on its foreign-sourced income and there are no withholding taxes in Hong Kong on remittance of dividends.

**Singapore.** Yisheng Singapore, a subsidiary incorporated in Singapore, files separate income tax returns in Singapore at the statutory income tax rate of 17%.

**China.** Under the Enterprise Income Tax (“EIT”) Law of the PRC, domestic enterprises and Foreign Investment Enterprises (the “FIE”) are usually subject to a unified 25% EIT rate while preferential tax rates, tax holidays, and even tax exemption may be granted on case-by-case basis. The PRC tax authorities grant preferential tax treatment to High and New Technology Enterprises (“HNTEs”). Under this preferential tax

treatment, HNTEs are entitled to an income tax rate of 15%, subject to a requirement that they re-apply for HNTE status every three years. Since Liaoning Yisheng was approved as an HNTE in December 2021, Liaoning Yisheng is entitled to a reduced income tax rate of 15% and is able to enjoy the reduced income tax rate in the next three years.

**United States.** US Yisheng, a subsidiary incorporated in Maryland, United States is subject to statutory federal corporate income tax at a rate of 21% and state income tax at a rate of 8.25%.

The provision for income tax consisted of the following:

	For the Years Ended March 31,		
	2021	2022	2022
	(RMB)	(RMB)	(US\$)
Current income tax	—	—	\$ —
Deferred tax	17,454,245	4,937,122	777,720
<b>Income tax</b>	<b>17,454,245</b>	<b>4,937,122</b>	<b>\$777,720</b>

The following table reconciles the statutory rate to YS Group's effective tax rate:

	For the Years Ended March 31,	
	2021	2022
PRC statutory income tax rate	25.00%	25.00%
Effect of different tax rates in different jurisdictions	(20.56)%	(18.26)%
Effect of PRC preferential tax rate	(0.77)%	4.56%
Effect of research and development expenses deduction and others	7.8%	33.2%
Temporary differences*	10.01%	4.88%
Change in valuation allowance	(11.49)%	(44.47)%
<b>Effective tax rate</b>	<b>10.01%</b>	<b>4.88%</b>

\* Temporary differences primarily relate to impairment of inventories, property, plant and equipment and government grants.

Net deferred tax assets as of March 31, 2022 and 2021, consist of the following key components:

	As of March 31,		
	2021	2022	2022
	(RMB)	(RMB)	(US\$)
<b>Deferred tax assets:</b>			
Write-down of inventories to net realizable value	6,195,269	825,454	\$ 130,030
Impairment of property, plant and building	2,293,516	2,031,460	320,006
Deferred government grants	4,950,884	4,852,383	764,371
Losses available for offsetting against future taxable profits	32,495,322	58,257,270	9,176,975
Less: valuation allowance	(32,495,322)	(58,257,270)	(9,176,975)
<b>Total deferred tax assets, net</b>	<b>13,439,669</b>	<b>7,709,297</b>	<b>1,214,407</b>
<b>Deferred tax liabilities:</b>			
Fair value adjustments arising from historical acquisition of subsidiaries	(5,463,463)	(4,670,213)	(735,675)
<b>Total deferred tax liabilities</b>	<b>(5,463,463)</b>	<b>(4,670,213)</b>	<b>(735,675)</b>
<b>Net deferred tax asset</b>	<b>7,976,206</b>	<b>3,039,084</b>	<b>\$ 478,732</b>

In assessing the realizability of the net deferred tax assets, YS Group considers all relevant positive and negative evidence in determining whether it is more likely than not that some portion or all of the deferred income tax

assets will not be realized. The realization of the gross deferred tax assets is dependent on several factors, including the generation of sufficient taxable income in the future. Based upon an assessment of the level of historical taxable income and projections for future taxable income over the periods in which the deferred tax assets are deductible or can be utilized, YS Group provided valuation allowance of RMB58.3 million and RMB32.5 million as of March 31, 2022 and 2021, respectively. The amount of the deferred tax asset is considered unrealizable because it is more likely than not that YS Group will not generate sufficient future taxable income to utilize this portion of the net operating loss.

#### *Uncertain tax positions*

There were no uncertain tax positions as of March 31, 2022 and 2021 and management does not anticipate any potential future adjustments which would result in a material change to its tax positions.

#### **NOTE 17—DEFERRED GOVERNMENT GRANTS**

Deferred government grants represent funds received from the PRC government for research and development, investment in building or improvement in YS Group's production facilities. These specific subsidies are recorded as deferred government grants upon receipt and are recognized as government grants recognized in income when the conditions are met. Other subsidies are recognized as other income upon receipt as further performance by YS Group is not required. YS Group received government grants that were deferred in the amount of RMB 3.6 million and RMB 1.6 million in fiscal 2022 and 2021, respectively. In addition, YS Group received RMB 20.8 million and RMB1.44 million other subsidies that the government has not set any conditions and are not tied to future trends or performance of YS Group and were recognized in other income in 2022 and 2021, respectively.

Deferred government grants included the following:

	As of March 31,		
	2021 (RMB)	2022 (RMB)	2022 (US\$)
<b>Government grants for property, plant and equipment</b>			
Balance at beginning of the year	21,096,442	21,847,340	\$3,441,502
Addition	2,000,000	1,552,000	244,479
Recognized as income	(1,249,102)	(1,368,650)	(215,597)
<b>Subtotal</b>	<b>21,847,340</b>	<b>22,030,690</b>	<b>\$3,470,384</b>
<b>Government grants for research and development</b>			
Balance at beginning of the year	10,387,874	11,158,551	\$1,757,750
Addition	1,610,700	—	—
Recognized as income	(840,023)	(840,023)	(132,325)
<b>Subtotal</b>	<b>11,158,551</b>	<b>10,318,528</b>	<b>\$1,625,425</b>
<b>Total deferred government grants</b>	<b>33,005,891</b>	<b>32,349,218</b>	<b>\$5,095,809</b>
<b>Less: current portion</b>	<b>(2,121,645)</b>	<b>(2,295,701)</b>	<b>(361,630)</b>
<b>Non-current portion</b>	<b>30,884,246</b>	<b>30,053,517</b>	<b>\$4,734,179</b>

#### *Government grants for property, plant and equipment*

YS Group has seven deferred government grants related to property, plant and equipment, and has fulfilled the conditions attached to all the grants. RMB 1.4 million was amortized from deferred government grant into government grant recognized in income in fiscal 2022, as compared to RMB1.2 million for the fiscal year ended March 31, 2021. RMB1.5 million will be amortized in fiscal 2023 which was included in the current deferred government grant and RMB 20.6 million will be amortized after 2023 which was included in the non-current portion of deferred government grants. RMB18.5 million was recorded as government grant recognized in income for the fiscal year ended March 31, 2022, as compared to nil for the fiscal years ended March 31, 2021.



**Government grants for research and development**

YS Group has two deferred government grants related to various research and development projects, and fulfilled the conditions attached to one grant in 2010. RMB 0.8 million was amortized from deferred government grant into government grant recognized in income in fiscal 2022, same as that for the year ended March 31, 2021. RMB 0.8 million will be amortized in fiscal 2023 which was included in the current deferred government grant and RMB 1.4 million will be amortized after 2023 which was included in the non-current portion of deferred government grants. The remaining grant's condition is expected to be fulfilled after 2022 and RMB 8.1 million is recorded in the non-current portion of deferred government grants. RMB2.0 million was recorded as government grant recognized in income for the year ended March 31, 2022, as compared to nil for the years ended March 31, 2021.

**NOTE 18 — COMMITMENTS AND CONTINGENCIES**

As of March 31, 2022, YS Group has the following commitments to purchase raw materials or services:

	As of March 31,	
	2022	2022
	(RMB)	(US\$)
Other professional service fee	7,617,840	\$ 1,200,000
Research and development	73,894,705	11,640,261
Purchase raw materials	17,664,500	17,664,500
<b>Total</b>	<b>99,177,045</b>	<b>\$30,504,761</b>

In year 2018, Liaoning Yisheng filed a sales contract dispute with Hebei Defense Biological Products Supply Center. The Supreme People's Court of Liaoning supported the Liaoning Yisheng's claim that the defendant Hebei Weifang should pay RMB2,465,807 for Liaoning Yisheng vaccine within 20 days after the judgment came into effect. As of the date of this report, YS Group received RMB1,636,755 compensation from Hebei Defense Biological Products Supply Center and the balance of RMB829,052 compensation may be received in fiscal 2024.

In year 2019, Liaoning Yisheng filed a sales contract dispute with Chaoyang Center for Disease Control and Prevention. The Supreme People's Court of Liaoning supported the Liaoning Yisheng's claim that the defendant Chaoyang Center for Disease Control and Prevention should pay RMB416,900 for Liaoning Yisheng vaccine. To the date, YS Group received RMB300,000 from Chaoyang Center for Disease Control and Prevention, and the balance of RMB116,900 may be received in fiscal 2023.

YS Group was also involved in certain other labor disputes as of March 31, 2022. As the proceedings are in the early stages, there is considerable uncertainty regarding the timing or ultimate resolution of such matters, and therefore, an estimate for the reasonably possible loss or a range of reasonably possible losses cannot be made.

**NOTE 19 — SEGMENT INFORMATION**

Based on management's assessment, YS Group has one operating segment, which is the development, production, marketing and sale of biopharmaceutical products. No operating segments were aggregated to form the reportable operating segment.

YS Group's non-current assets are located in the PRC and other countries, such as Singapore and United States. The location of these non-current assets can be aggregated to form the reportable geographical segment.

	As of March 31,		
	2021	2022	2022
	(RMB)	(RMB)	(US\$)
PRC	288,637,839	604,094,049	\$95,159,896
Other countries/regions	31,345,723	26,777,039	\$ 4,218,052

The non-current asset information above is based on the location of the assets and excludes financial instruments and deferred tax assets.

#### NOTE 20—SUBSEQUENT EVENTS

YS Group performed an evaluation of events and transactions for potential recognition or disclosure through the date of this report. YS Group is not aware of any material subsequent events other than those disclosed below and elsewhere in the notes to the consolidated financial statements.

On August 15, 2022, Oceanview Bioscience Acquisition Co., Ltd. (“Oceanview Bioscience”) and Hudson Biomedical Group Co., Ltd. (“Hudson Biomedical”) were incorporated under the laws of Cayman Islands as exempted companies with limited liability. The companies were incorporated for the purpose of effecting a merger with Summit Healthcare Acquisition Corp, a Special Purpose Acquisition Company (“SPAC”).

On August 15, 2022, unanimous written resolutions of the board of directors of YS Group accepted the notice from a former employee, relating to the surrender of 575,000 of issued shares with US\$0.000005 each in YS Group registered in his name.

#### NOTE 21—PARENT COMPANY ONLY CONDENSED FINANCIAL INFORMATION (UNAUDITED)

Pursuant to the requirements of Rule 12-04(a), 5-04(c) and 4-08(e)(3) of Regulation S-X, the condensed financial information of the parent company shall be filed when the restricted net assets of consolidated subsidiaries exceed 25% of consolidated net assets as of the end of the most recently completed fiscal year. YS Group performed a test on the restricted net assets of consolidated subsidiaries in accordance with such requirement and concluded that it was applicable to YS Group as the restricted net assets of YS Group’s PRC subsidiaries exceeded 25% of the consolidated net assets of YS Group. Therefore, the condensed financial statements of the parent company are included herein.

#### PARENT COMPANY BALANCE SHEETS

	As of March 31,		
	2021 (RMB) (Unaudited)	2022 (RMB) (Unaudited)	2022 (US\$) (Unaudited)
<b>ASSETS</b>			
<b>Current Assets</b>			
Cash	330,296,949	252,611,535	\$ 39,792,624
Amounts due from related parties	495,937,171	519,236,876	81,792,772
<b>Total current assets</b>	<b>826,234,120</b>	<b>771,848,411</b>	<b>121,585,396</b>
<b>Non-current assets</b>			
Long-term investments, net	150,952,826	146,641,652	23,099,721
<b>Total non-current assets</b>	<b>150,952,826</b>	<b>146,641,652</b>	<b>23,099,721</b>
<b>Total Assets</b>	<b>977,186,946</b>	<b>918,490,063</b>	<b>\$ 144,685,117</b>
<b>LIABILITIES AND EQUITY</b>			
<b>Current Liabilities</b>			
Accrued expenses and other liabilities	197,324,794	244,082,463	\$ 38,449,082
Amounts due to related parties	3,266,288	3,155,395	497,053
<b>Total current liabilities</b>	<b>200,591,082</b>	<b>247,237,858</b>	<b>38,946,135</b>
<b>Total Liabilities</b>	<b>200,591,082</b>	<b>247,237,858</b>	<b>38,946,135</b>
<b>Mezzanine equity</b>			
Series A and A-1 redeemable convertible preferred shares (par value US\$0.000005 per share, 50,000,000 shares authorized; 21,548,589 shares issued and outstanding as of March 31, 2022 and 2021)	410,327,208	458,074,468	72,158,166
Series B redeemable convertible preferred shares (par value US\$0.000005 per share, 100,000,000 shares authorized; 65,414,858 shares issued and outstanding as of March 31, 2022 and 2021)	875,131,363	912,146,924	143,685,915
<b>Total mezzanine equity</b>	<b>1,285,458,571</b>	<b>1,370,221,392</b>	<b>215,844,081</b>

	As of March 31,		
	2021	2022	2022
	(RMB)	(RMB)	(US\$)
	(Unaudited)	(Unaudited)	(Unaudited)
<b>Shareholders' deficit:</b>			
Ordinary shares, par value US\$0.000005 per share, 9,950,000,000 shares authorized, 247,311,533 shares issued and outstanding as of March 31, 2022 and 2021*	7,978	7,978	1,257
Additional paid-in capital	800,806,378	808,502,018	127,359,254
Retained earnings	(1,353,900,436)	(1,590,567,163)	(250,554,041)
Accumulated other comprehensive income	44,223,373	83,087,980	13,088,431
<b>Total shareholders' deficit</b>	<b>(508,862,707)</b>	<b>(698,969,187)</b>	<b>(110,105,099)</b>
<b>Total liabilities, mezzanine equity and shareholders' deficit</b>	<b>977,186,946</b>	<b>918,490,063</b>	<b>\$ 144,685,117</b>

\* Gives retroactive effect to reflect the reorganization in February 2021.

#### PARENT COMPANY STATEMENTS OF OPERATIONS AND COMPREHENSIVE LOSS

	For the Years Ended March 31,		
	2021	2022	2022
	(RMB)	(RMB)	(US\$)
	(Unaudited)	(Unaudited)	(Unaudited)
<b>Equity loss of subsidiaries</b>	<b>(60,903,713)</b>	<b>(75,864,722)</b>	<b>\$ (11,950,588)</b>
<b>Operating expenses:</b>			
Selling expenses	54,278	—	—
General and administrative expenses	104,562,058	29,178,255	4,596,304
Research and development expenses	4,352,356	988,531	155,718
<b>Total operating expenses</b>	<b>108,968,692</b>	<b>30,166,786</b>	<b>4,752,022</b>
<b>Loss from operations</b>	<b>(169,872,405)</b>	<b>(106,031,508)</b>	<b>(16,702,610)</b>
<b>Other income (expenses)</b>			
Financial income/(expenses), net	(21,953,837)	27,107	4,270
Total other income/(expenses), net	(21,953,837)	27,107	4,270
<b>Net loss</b>	<b>(191,826,242)</b>	<b>(106,004,401)</b>	<b>(16,698,340)</b>
Accretion to redemption value of convertible redeemable preferred shares	(16,610,297)	(130,662,326)	(20,582,579)
<b>Net loss attributable to YS Biopharma</b>	<b>(208,436,538)</b>	<b>(236,666,727)</b>	<b>(37,280,919)</b>
<b>Net loss</b>	<b>(191,826,242)</b>	<b>(106,004,401)</b>	<b>(16,698,340)</b>
Foreign currency translation gain	22,455,217	38,864,607	6,122,146
<b>Total comprehensive loss</b>	<b>(169,371,025)</b>	<b>(67,139,794)</b>	<b>\$ (10,576,194)</b>
<b>Loss per share*:</b>			
– Basic and Diluted	(0.78)	(0.43)	\$ (0.07)
<b>Weighted average number of ordinary shares outstanding*:</b>			
– Basic and Diluted	247,311,533	247,311,533	247,311,533

\* Gives retroactive effect to reflect the reorganization in February 2021.

## PARENT COMPANY STATEMENTS OF CASH FLOWS

	For the Fiscal Years Ended March 31,		
	2021	2022	2022
	(RMB)	(RMB)	(US\$)
	(Unaudited)	(Unaudited)	(Unaudited)
Net loss	(191,826,242)	(106,004,401)	\$(16,698,340)
Equity loss of subsidiaries	60,903,713	75,864,722	11,950,588
Share-based compensation	76,756,500	7,764,448	1,223,094
Changes in operating assets and liabilities:			
Amounts due from related parties	(421,125,633)	(23,299,705)	(3,670,285)
Amounts due to related parties	2,906,881	(110,893)	(17,468)
Accrued expenses and other liabilities	77,228,629	(24,732,348)	(3,895,962)
<b>Net cash used in operating activities</b>	<b>(395,156,152)</b>	<b>(70,518,177)</b>	<b>(11,108,373)</b>
Cash flows from investing activities:			
Payment for long-term investment	(7,658,738)	(813,776)	(128,190)
<b>Net cash used in investing activities</b>	<b>(7,658,738)</b>	<b>(813,776)</b>	<b>(128,190)</b>
Cash flows from financing activities:			
Proceeds from issuance of mezzanine equity	729,412,999	—	—
Shareholders' contributions	1,589,236	—	—
<b>Net cash provided by financing activities</b>	<b>731,002,235</b>	<b>—</b>	<b>—</b>
Effect of exchange rate on cash	2,109,604	(6,353,461)	(1,000,829)
<b>Net (decrease) increase in cash</b>	<b>330,296,949</b>	<b>(77,685,414)</b>	<b>(12,237,392)</b>
<b>Cash at the beginning of the year</b>	<b>—</b>	<b>330,296,949</b>	<b>52,030,016</b>
<b>Cash at the end of the year</b>	<b>330,296,949</b>	<b>252,611,535</b>	<b>\$ 39,792,624</b>
<b>Non-cash transactions:</b>			
Accretion to redemption value of convertible redeemable preferred shares	16,610,297	130,662,326	\$ 20,582,579
Forgiveness from related parties	446,092,527	—	\$ —

**YISHENGBIO CO., LTD AND SUBSIDIARIES**  
**CONDENSED CONSOLIDATED BALANCE SHEETS**

	March 31, 2022 (RMB)	September 30, 2022 (RMB) (Unaudited)	September 30, 2022 (\$) (Unaudited)
<b>ASSETS</b>			
<b>Current Assets</b>			
Cash	271,067,503	226,765,500	\$ 31,939,703
Restricted cash	—	261,766	36,869
Accounts receivable, net	308,555,105	468,359,388	65,967,969
Advance to suppliers	10,648,306	7,556,142	1,064,275
Inventories, net	166,505,565	161,667,187	22,770,668
Prepaid expenses and other current assets	7,987,914	6,942,700	977,873
<b>Total current assets</b>	<b>764,764,393</b>	<b>871,552,683</b>	<b>122,757,357</b>
<b>Non-current assets</b>			
Property, plant and equipment, net	550,153,110	557,366,853	78,504,585
Operating lease right-of-use assets, net	14,850,283	13,067,129	1,840,493
Deferred tax assets, net	3,039,084	2,473,459	348,384
Intangible assets, net	80,717,978	81,314,933	11,453,130
Other assets, non-current	28,228,293	22,663,063	3,192,071
<b>Total non-current assets</b>	<b>676,988,748</b>	<b>676,885,437</b>	<b>95,338,663</b>
<b>Total Assets</b>	<b>1,441,753,141</b>	<b>1,548,438,120</b>	<b>\$ 218,096,020</b>
<b>LIABILITIES, MEZZANINE EQUITY AND SHAREHOLDERS' DEFICIT</b>			
<b>Current Liabilities</b>			
Bank loans and other borrowing – current	111,733,754	163,641,078	\$ 23,048,688
Accounts payable	30,811,100	37,394,178	5,266,934
Accrued expenses and other liabilities	326,751,353	367,283,321	51,731,502
Operating lease liabilities – current	4,322,252	3,524,558	496,431
Deferred government grants – current	2,295,701	3,495,701	492,366
<b>Total current liabilities</b>	<b>475,914,160</b>	<b>575,338,836</b>	<b>81,035,921</b>
<b>Non-current Liabilities</b>			
Bank loans and other borrowing – non-current	253,928,000	283,992,000	40,000,000
Operating lease liabilities – non-current	10,605,260	10,403,843	1,465,371
Deferred government grants – non-current	30,053,517	20,826,966	2,933,458
<b>Total non-current liabilities</b>	<b>294,586,777</b>	<b>315,222,809</b>	<b>44,398,829</b>
<b>Total Liabilities</b>	<b>770,500,937</b>	<b>890,561,645</b>	<b>125,434,750</b>
<b>Mezzanine equity</b>			
Series A and Series A-1 redeemable convertible preferred shares (par value US\$0.000005 per share, 50,000,000 shares authorized; 21,548,589 shares issued and outstanding)	458,074,468	551,004,725	77,608,485
Series B redeemable convertible preferred shares (par value US\$0.000005 per share, 100,000,000 shares authorized; 65,414,858 shares issued and outstanding)	912,146,924	1,057,557,002	148,955,886
<b>Total mezzanine equity</b>	<b>1,370,221,392</b>	<b>1,608,561,727</b>	<b>226,564,371</b>
<b>Commitments and Contingencies</b>			
<b>Shareholders' deficit</b>			
Ordinary shares, par value US\$0.000005 per share, 9,950,000,000 shares authorized, 247,311,533 shares issued and outstanding as of March 31, 2022, and 246,736,533 shares issued and outstanding as of September 30, 2022.*	7,978	7,978	1,124
Additional paid-in capital	808,502,018	808,648,509	113,897,365
Accumulated Deficit	(1,590,567,163)	(1,673,775,766)	(235,749,706)
Accumulated other comprehensive income (loss)	83,087,979	(85,565,973)	(12,051,884)
<b>Total shareholders' deficit</b>	<b>(698,969,188)</b>	<b>(950,685,252)</b>	<b>(133,903,101)</b>
<b>Total liabilities, mezzanine equity and shareholders' deficit</b>	<b>1,441,753,141</b>	<b>1,548,438,120</b>	<b>\$ 218,096,020</b>

The accompanying notes are an integral part of these unaudited condensed consolidated financial statements.

**YISHENGBIO CO., LTD AND SUBSIDIARIES**  
**UNAUDITED CONDENSED CONSOLIDATED STATEMENTS OF OPERATIONS AND**  
**COMPREHENSIVE LOSS**

	Six Months Ended September 30,		
	2021	2022	2022
	(RMB)	(RMB)	(\$)
	(Unaudited)	(Unaudited)	(Unaudited)
<b>Revenues</b>	<b>269,433,426</b>	<b>399,534,723</b>	<b>\$ 56,274,081</b>
Cost of revenues	63,599,621	93,700,779	13,197,665
<b>Gross profit</b>	<b>205,833,805</b>	<b>305,833,944</b>	<b>43,076,416</b>
<b>Operating expenses:</b>			
Selling	86,265,281	150,228,079	21,159,480
General and administrative	51,664,591	49,587,013	6,984,283
Research and development	124,051,209	123,861,107	17,445,718
<b>Total operating expenses</b>	<b>261,981,081</b>	<b>323,676,199</b>	<b>45,589,481</b>
<b>Loss from operations</b>	<b>(56,147,276)</b>	<b>(17,842,255)</b>	<b>(2,513,065)</b>
<b>Other income (expenses):</b>			
Late fees related to tax other than income tax	(112,420)	—	—
Late fee related to social security insurance	(1,396,221)	(299,417)	(42,173)
Government grants	19,600,822	22,456,691	3,163,003
Financial expenses, net	(352,694)	(14,949,434)	(2,105,613)
Other (expense) income, net	(993,957)	74,675	10,518
<b>Total other income, net</b>	<b>16,745,530</b>	<b>7,282,515</b>	<b>1,025,735</b>
<b>Loss before income taxes</b>	<b>(39,401,746)</b>	<b>(10,559,740)</b>	<b>(1,487,330)</b>
<b>Income tax expense</b>	<b>(5,689,586)</b>	<b>(565,625)</b>	<b>(79,668)</b>
<b>Net loss</b>	<b>(45,091,332)</b>	<b>(11,125,365)</b>	<b>(1,566,998)</b>
Accretion to redemption value of convertible redeemable preferred shares	(65,013,751)	(72,083,238)	(10,152,855)
<b>Net loss attributable to YishengBio Co. Ltd</b>	<b>(110,105,083)</b>	<b>(83,208,603)</b>	<b>\$ (11,719,853)</b>
<b>Net loss</b>	<b>(45,091,332)</b>	<b>(11,125,365)</b>	<b>\$ (1,566,998)</b>
Other comprehensive income (loss): foreign currency translation gain (loss)	11,321,167	(168,653,952)	(23,754,747)
<b>Total comprehensive loss</b>	<b>(33,770,165)</b>	<b>(179,779,317)</b>	<b>\$ (25,321,745)</b>
<b>Loss per share*:</b>			
– Basic and Diluted	(0.18)	(0.05)	\$ (0.01)
<b>Weighted average number of ordinary shares outstanding*:</b>			
– Basic and Diluted	247,311,533	247,141,861	247,141,861

\* Gives retroactive effect to reflect the reorganization in February 2021.

The accompanying notes are an integral part of these unaudited condensed consolidated financial statements.

## YISHENGBIO CO., LTD AND SUBSIDIARIES

## UNAUDITED CONDENSED CONSOLIDATED STATEMENTS OF CHANGES IN SHAREHOLDERS' DEFICIT

	Ordinary shares*		Additional paid-in capital	Deficit	Accumulated other comprehensive income (loss)	Total stockholders' deficit
	Shares	Amount				
	(RMB)	(RMB)	(RMB)	(RMB)	(RMB)	(RMB)
<b>Balance as of March 31, 2022</b>	<b>247,311,533</b>	<b>7,978</b>	<b>808,502,018</b>	<b>(1,590,567,163)</b>	<b>83,087,979</b>	<b>(698,969,188)</b>
Accretion to redemption value of convertible redeemable preferred shares	—	—	—	(72,083,238)	—	(72,083,238)
Net loss	—	—	—	(11,125,365)	—	(11,125,365)
Share-based compensation	(575,000)	—	(85,316)	—	—	(85,316)
Foreign currency translation adjustment	—	—	231,807	—	(168,653,952)	(168,422,145)
<b>Balance as of September 30, 2022 (in RMB) (unaudited)</b>	<b>246,736,533</b>	<b>7,978</b>	<b>808,648,509</b>	<b>(1,673,775,766)</b>	<b>(85,565,973)</b>	<b>(950,685,252)</b>
<b>Balance as of September 30, 2022 (In \$) (unaudited)</b>	<b>246,736,533</b>	<b>1,124</b>	<b>113,897,365</b>	<b>(235,749,706)</b>	<b>(12,051,884)</b>	<b>(133,903,101)</b>
	Ordinary shares*		Additional paid-in capital	Deficit	Accumulated other comprehensive income	Total stockholders' deficit
	Shares	Amount				
	(RMB)	(RMB)	(RMB)	(RMB)	(RMB)	(RMB)
<b>Balance as of March 31, 2021</b>	<b>247,311,533</b>	<b>7,978</b>	<b>800,806,378</b>	<b>(1,353,900,436)</b>	<b>44,223,373</b>	<b>(508,862,707)</b>
Accretion to redemption value of convertible redeemable preferred shares	—	—	—	(65,013,751)	—	(65,013,751)
Net loss	—	—	—	(45,091,332)	—	(45,091,332)
Share-based compensation	—	—	3,128,741	—	—	3,128,741
Foreign currency translation adjustment	—	—	—	—	11,321,167	11,321,167
<b>Balance as of September 30, 2021 (In RMB) (unaudited)</b>	<b>247,311,533</b>	<b>7,978</b>	<b>803,935,119</b>	<b>(1,464,005,519)</b>	<b>55,544,540</b>	<b>(604,517,882)</b>
<b>Balance as of September 30, 2021 (In \$) (unaudited)</b>	<b>247,311,533</b>	<b>1,124</b>	<b>113,233,488</b>	<b>(206,203,769)</b>	<b>7,823,395</b>	<b>(85,145,762)</b>

\* Gives retroactive effect to reflect the reorganization in February 2021.

The accompanying notes are an integral part of these unaudited condensed consolidated financial statements.

**YISHENGBIO CO., LTD AND SUBSIDIARIES**  
**UNAUDITED CONDENSED CONSOLIDATED STATEMENTS OF CASH FLOWS**

	Six Months Ended September 30,		
	2021	2022	2022
	(RMB) (Unaudited)	(RMB) (Unaudited)	(\$) (Unaudited)
<b>Cash flows from operating activities:</b>			
Net loss	(45,091,332)	(11,125,365)	\$ (1,566,997)
Adjustments to reconcile net loss to net cash used in operating activities:			
Deferred income taxes	5,689,586	565,625	79,668
Depreciation of property, plant and equipment	11,560,041	13,818,386	1,946,306
Amortization of intangible assets	3,326,419	3,409,643	480,245
Loss on disposal of property, plant and equipment	238,279	64,179	9,040
Share-based compensation	3,128,741	(85,316)	(12,017)
Impairment of accounts receivable	2,888,417	6,447,109	908,069
Non-cash lease expense	1,805,910	2,409,286	339,346
Changes in operating assets and liabilities:			
Inventories	(40,481,983)	4,838,379	681,481
Accounts receivable	(96,243,492)	(166,251,393)	(23,416,349)
Amounts due from related parties	30,088,833		
Prepaid expenses and other current assets	(31,314,821)	4,102,924	577,893
Accounts payable	16,697,346	6,583,078	927,220
Accrued expenses and other liabilities	(37,906,402)	37,289,942	5,252,252
Deferred government grants	491,177	(8,026,551)	(1,130,532)
Operating lease liabilities	(1,861,093)	(1,435,079)	(202,129)
<b>Net cash used in operating activities</b>	<b>(176,984,374)</b>	<b>(107,395,153)</b>	<b>(15,126,504)</b>
<b>Cash flows from investing activities:</b>			
Proceeds from disposal of property, plant and equipment	8,000	—	—
Purchases of property, plant and equipment	(202,828,177)	(15,017,753)	(2,115,236)
Purchases of intangible assets	(570,200)	(4,006,598)	(564,325)
<b>Net cash used in investing activities</b>	<b>(203,390,377)</b>	<b>(19,024,351)</b>	<b>(2,679,561)</b>
<b>Cash flows from financing activities:</b>			
Proceeds from bank loans and other borrowings	92,719,786	102,513,927	14,438,988
Repayment of bank and other borrowings	(48,833,921)	(50,606,602)	(7,127,891)
<b>Net cash provided by financing activities</b>	<b>43,885,865</b>	<b>51,907,325</b>	<b>7,311,097</b>
Effect of foreign exchange rate on cash	(4,446,301)	30,471,942	4,291,943
<b>Net decrease in cash and restricted cash</b>	<b>(340,935,187)</b>	<b>(44,040,237)</b>	<b>(6,203,025)</b>
<b>Cash and restricted cash at the beginning of the period</b>	<b>390,457,084</b>	<b>271,067,503</b>	<b>38,179,597</b>
<b>Cash and restricted cash at the end of the period</b>	<b>49,521,897</b>	<b>227,027,266</b>	<b>\$ 31,976,572</b>
<b>Reconciliation of cash and restricted cash</b>			
Cash	49,521,897	226,765,500	31,939,703
Restricted cash	—	261,766	36,869
<b>Total cash and restricted cash shown in the statements of cash flows</b>	<b>49,521,897</b>	<b>227,027,266</b>	<b>31,976,572</b>
<b>Supplemental disclosures of cash flow information:</b>			
Interest paid	402,617	12,723,051	\$ 1,792,030
<b>Non-cash transactions:</b>			
Accretion to redemption value of convertible redeemable preferred shares	65,013,751	72,083,238	\$ 10,152,855

The accompanying notes are an integral part of these unaudited condensed consolidated financial statements.



**YISHENGBIO CO., LTD AND SUBSIDIARIES****NOTES TO THE UNAUDITED CONDENSED CONSOLIDATED FINANCIAL STATEMENTS****As of September 30, 2022 and March 31, 2022****NOTE 1 — ORGANIZATION AND BUSINESS DESCRIPTION**

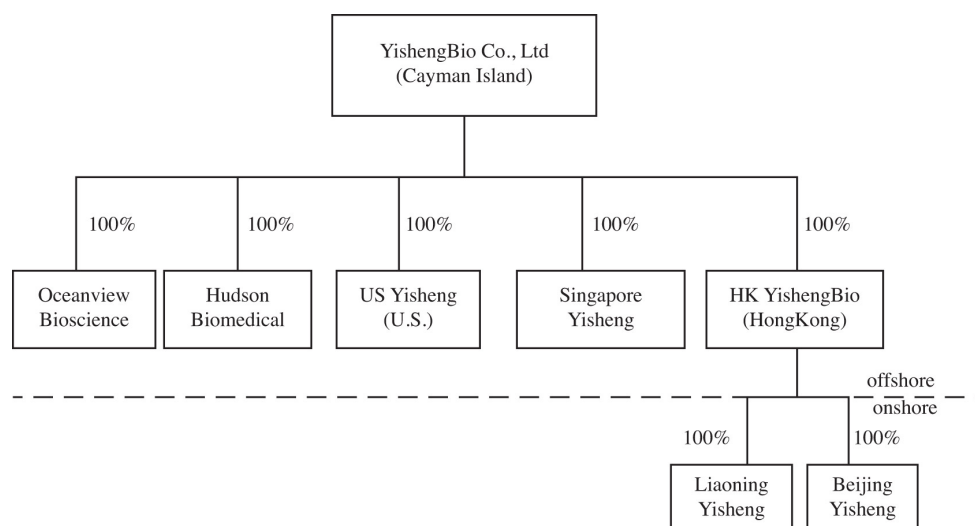
YishengBio Co., Ltd (“YS Biopharma”) was incorporated under the laws of Cayman Islands as an exempted company with limited liability in November 2020. It owns five companies and their subsidiaries that were incorporated in the United States of America (“US”), Singapore, Hong Kong and the People’s Republic of China (“China” or the “PRC”) (collectively, the “YS Group”). YS Group is principally engaged in the research, development, manufacturing and sale of vaccines and therapeutic biologics. It developed a PIKA immunomodulating technology platform and a series of product candidates targeting rabies, hepatitis B, influenza and other indications. It produces and sells of YSJA™ (依生君安™) rabies vaccine, the first aluminum-free lyophilized rabies vaccine that was launched in China.

Prior to the business reorganization in February 2021, YS Group conducted its business under Yisheng Biopharma Co., Ltd (“Yisheng Biopharma”), a Cayman Islands company established in April 2010, as an offshore holding company used by its shareholders to hold and control its business operation. Before or after the reorganization, both YS Biopharma and Yisheng Biopharma are controlled by the same shareholder, Zhang Yi, founder and chairman of YS Group and Yisheng Biopharma.

In February 2021, YS Group’s business and technology segments were separated and spun-off from the parent company of Yisheng Biopharma Co., Ltd. by way of a series of corporate and business restructurings. In connection with such restructurings, YishengBio (Hong Kong) Holdings Limited (“HK YishengBio”) and Beijing Yisheng Biotechnology Co., Ltd. (“Beijing Yisheng”) were established under the laws of Hong Kong in December 2020 and the PRC in February 2021, respectively. In January 2021 and February 2021, Liaoning Yisheng Bio-Pharma Co., Ltd. (“Liaoning Yisheng”) and Beijing Yisheng became wholly-owned subsidiaries of HK YishengBio. In December 2020, YS Biopharma issued shares and entered into shareholders agreements with the then shareholders of Yisheng Biopharma to substantially mirror their respective interests in Yisheng Biopharma to YS Biopharma. In January 2021, YS Biopharma acquired all the equity interests of Yisheng US Biopharma Inc. (“US Yisheng”) and Yisheng Biopharma (Singapore) Pte. Ltd. (“Singapore Yisheng”) from Yisheng Biopharma, both of which became wholly-owned subsidiaries of YS Biopharma. In February 2021, Beijing Yisheng acquired all the relevant assets and business from a subsidiary of Yisheng Biopharma. The restructuring was completed in February 2021. After the reorganization, there is no equity relationship, no business activities and no business relevance or competition between Yisheng Biopharma and YS Biopharma, and both are controlled by the same shareholder, Zhang Yi.

On August 17, 2022, Oceanview Bioscience Acquisition Co., Ltd. (“Oceanview Bioscience”) and Hudson Biomedical Group Co., Ltd. (“Hudson Biomedical”) were incorporated under the laws of Cayman Islands as exempted companies with limited liability. The companies were incorporated for the purpose of effecting a merger with Summit Healthcare Acquisition Corp, a Special Purpose Acquisition Company (“SPAC”).

YS Group’s current legal entity structure is as follows:



As of the date of this report, YS Group is consists of the following legal entities:

<u>'Legal Entity</u>	<u>Nature of Operations</u>	<u>Date of Incorporation</u>	<u>Place of Incorporation</u>
YishengBio Co., Ltd ("YS Biopharma")	Holding Company	November 16, 2020	Cayman Islands
YishengBio (Hong Kong) Holdings Limited ("HK YishengBio")	Holding Company	December 28, 2020	Hong Kong
Yisheng Biopharma (Singapore) Pte. Ltd. ("Singapore Yisheng")*	Research and development of vaccines and therapeutic biologics	November 28, 2009	Singapore
Yisheng US Biopharma Inc. ("US Yisheng")	Research of vaccines and therapeutic biologics	September 29, 2009	US
Oceanview Bioscience Acquisition Co., Ltd ("Oceanview Bioscience")	For acquisition	August 17, 2022	Cayman Islands
Hudson Biomedical Group Co., Ltd ("Hudson Biomedical")	For acquisition	August 17, 2022	Cayman Islands
Liaoning Yisheng Bio-Pharma Co., Ltd. ("Liaoning Yisheng")**	Research and development, manufacturing and commercialization of vaccines and therapeutic biologics	May 26, 1994	PRC
Beijing Yisheng Biotechnology Co., Ltd. ("Beijing Yisheng")	Research and development of vaccines and therapeutic biologics	February 4, 2021	PRC

\* Singapore Yisheng was incorporated November 28, 2009, and acquired by YS Group in fiscal 2011.

\*\* Liaoning Yisheng was incorporated May 26, 1994, and acquired by YS Group in fiscal 2005.

## NOTE 2 — LIQUIDITY

As reflected in the accompanying unaudited condensed consolidated financial statements ("CFS"), YS Group reported net loss of RMB 11,125,365 and RMB45,091,332 for six months ended September 30, 2022 and

2021, respectively. Cash used in operating activities was RMB 107,395,153 and RMB 176,984,374 for the six months ended September 30, 2022 and 2021, respectively.

In assessing its liquidity, management monitors and analyzes YS Group's cash, its ability to generate sufficient revenue sources in the future, and its operating and capital expenditure commitments. As of September 30, 2022, YS Group had cash and restricted cash of approximately RMB227.0 million (\$32.0 million). As of September 30, 2022, YS Group had outstanding bank loans and other borrowing of approximately RMB447.6 million (\$63.0 million) from various financial institutions.

Currently, YS Group is working to improve its liquidity and capital sources primarily through cash flows from operations, debt and equity financing. Based on the Company's current operating plan, management believes the above-mentioned measures collectively will provide sufficient liquidity for YS Group to meet its future liquidity and capital requirement for at least 12 months from the date of this report.

### **NOTE 3—SUMMARY OF SIGNIFICANT ACCOUNTING POLICIES**

#### ***Basis of Presentation***

The accompanying unaudited interim condensed CFS of YS Group were prepared in accordance with the accounting principles generally accepted in the United States of America ("U.S. GAAP") and applicable rules and regulations of the Securities and Exchange Commission ("SEC"). These unaudited interim condensed CFS do not include all of the information and footnotes required by U.S. GAAP for annual financial statements.

In the opinion of YS Group's management, the accompanying unaudited interim condensed CFS contain all normal recurring adjustments necessary to present fairly the financial position, operating results and cash flows of YS Group for each of the periods presented. The results of operations for the six months ended September 30, 2022 are not necessarily indicative of results to be expected for any other interim periods or for the year ending March 31, 2023. These unaudited interim condensed CFS should be read in conjunction with YS Group's audited CFS for the years ended March 31, 2022 and 2021.

#### ***Basis of Consolidation***

The CFS include the financial statements of YS Group and its wholly-owned subsidiaries. All significant intercompany transactions and balances were eliminated in consolidation. The CFS were prepared on a historical cost basis, except for financial assets and financial liabilities which were measured at fair value. The functional currency of YS Group and its Hong Kong subsidiary, US subsidiary is the United States dollars ("US\$"). The functional currency of YS Group's Singapore subsidiary is the Singapore dollars ("S\$"). The functional currency of YS Group's PRC subsidiaries is the Chinese Renminbi ("RMB"). The determination of functional currency is based on the criteria of Accounting Standard Codifications ("ASC") as promulgated by the Financial Accounting Standards Board, ASC 830, Foreign Currency Matters ("ASC 830"). YS Group uses the RMB as its reporting currency.

The business reorganization as described in Note 1 was treated as a recapitalization of entities under common control and the accompanying CFS of YS Group give retroactive effect to this transaction.

#### ***Use of Estimates***

The preparation of the CFS in conformity with U.S. GAAP requires management to make estimates and assumptions that affect the reported amounts of assets and liabilities and disclosure of contingent assets and liabilities at the date of the CFS and the reported amounts of revenues and expenses during the reporting periods. Significant estimates and assumptions reflected in these CFS include, but are not limited to, the valuation of YS Group's convertible redeemable preferred shares and ordinary shares, accrual of stock-based compensation expense, allowance for doubtful accounts and obsolete inventories, useful life of property, plant and equipment, income taxes and uncertain tax positions. Actual amounts could differ from those estimates. Changes in estimates are recorded in the period in which they become known. Due to the risks and uncertainties involved in YS Group's business and evolving market conditions and, given the subjective element of the estimates and assumptions made, actual results may differ from estimated results.

### ***Foreign Currency Translation***

YS Group's CFS are reported using the RMB. The results of operations and the consolidated statements of cash flows denominated in foreign currency are translated at the average rate of exchange during the reporting period. Assets and liabilities denominated in foreign currencies at the balance sheet date are translated at the applicable rates of exchange in effect. The equity denominated in the functional currency is translated at the historical rate of exchange then in time of capital transaction. Because cash flows are translated based on the average translation rate, amounts related to assets and liabilities reported on the consolidated statements of cash flows will not necessarily agree with changes in the corresponding balances on the consolidated balance sheets. Foreign currency translation adjustments arising from the use of different exchange rates from period to period are included as a separate component of accumulated other comprehensive income (loss) included in YS Group's consolidated statements of changes in shareholders' deficit. Gains and losses from foreign currency transactions are included in YS Group's consolidated statements of operations and comprehensive loss.

The value of RMB against US\$ and other currencies may fluctuate and is affected by, among other things, changes in the PRC's political and economic conditions. The following table outlines the currency exchange rates used in preparing YS Group's CFS:

Foreign currency	September 30, 2022	March 31, 2022	Six Months Ended	
			September 30,	
			2022	2021
	Balance Sheet	Balance Sheet	Profit/Loss	Profit/Loss
<b>RMB:1\$</b>	7.0998	6.3482	6.7240	6.5284
<b>RMB:1\$</b>	4.9717	4.6932	4.8325	4.8200

### ***Convenience translation***

Amounts in \$ are presented for the convenience of the reader and translated at \$1.00 to RMB 7.0998, the central parity rate release of the People's Bank of China on September 30, 2022. No representation is made that the RMB amounts could have been, or converted, realized or settled into \$ at such rate.

### ***Cash***

Cash includes cash on hand and demand deposits in accounts maintained with commercial banks. YS Group maintains bank accounts in China. Cash balances in bank accounts in China are not insured by the Federal Deposit Insurance Corporation or other programs.

### ***Restricted Cash***

Restricted cash balances mainly relate to restrictions imposed on banks as cash deposits for the issuance of letters of credit. And it is included in the total cash, cash equivalents, and restricted cash in the consolidated statements of cash flows.

### ***Accounts Receivable, net***

Accounts receivable are presented net of allowance for doubtful accounts. YS Group reduces its accounts receivable by recording a bad debt allowance to account for the estimated impact of collection issues resulting from a client's inability or unwillingness to pay valid obligations to YS Group. YS Group determines the adequacy of allowance for doubtful accounts based on individual account analysis, historical collection trend, and best estimate of specific losses on individual exposures. YS Group establishes an allowance for doubtful accounts when there is objective evidence that YS Group may not be able to collect amounts due. Accounts receivable balances are written off after all collection efforts have been exhausted.

### ***Advance to Suppliers***

Advance to suppliers is amounts advanced to vendors or suppliers for providing raw materials to YS Group. The suppliers usually require advance payments when YS Group orders materials and the advance will be

utilized to offset YS Group's actual payment obligations. These amounts advanced are unsecured, non-interest bearing and generally short term in nature. YS Group will reduce its advance to suppliers by recording an allowance that approximates the extent of the advance that may not be realizable during the procurement process. YS Group did not record any allowance against its advance to suppliers as of September 30, 2022 or March 31, 2022.

#### ***Inventories, net***

Inventories are stated at the lower of cost or net realizable value. Cost is determined on the weighted average basis and comprises all cost of purchase and other costs incurred in bringing the inventories to their present location and condition. Net realizable value is based on estimated selling prices less any estimated costs to be incurred to completion and disposal.

YS Group reviews the carrying amounts of the inventories on quarterly to determine whether the inventories are carried at lower of carrying amount or net realizable value. The net realizable value is estimated based on current market situation and historical experience.

Adjustments are recorded to write down the cost of inventory based on the expiration date of raw materials and the estimate of future usage. Write-downs are recorded in cost of revenue in the consolidated statements of operations and comprehensive loss.

#### ***Property, Plant and Equipment, net***

Property, plant and equipment are stated at cost less accumulated depreciation and any impairment losses. The cost of property, plant and equipment comprises its purchase price and any directly attributable costs of bringing the asset to its working condition and location for its intended use.

Expenditure incurred after items of property, plant and equipment have been put into operation, such as repairs and maintenance, is normally expensed in the period in which it is incurred. When the recognition criteria are satisfied, the expenditure for a major reconstruction is capitalized in the carrying amount of the asset as a replacement. Where significant parts of property, plant and equipment are required to be replaced at intervals, YS Group recognizes such parts as individual assets with specific useful lives and depreciates them accordingly.

Depreciation is calculated on the straight-line basis to reduce the cost of each item of property, plant and equipment to its residual value over its estimated useful life.

Category	Estimated useful life
Plant and building	6 – 20 years
Machinery and equipment	5 – 10 years
Furniture and fixtures	3 – 7 years
Motor vehicles	4 – 5 years
Leasehold improvements	Lesser of the lease term or life of assets

Where parts of an item of property, plant and equipment have different useful lives, the cost of that item is allocated on a reasonable basis among the parts and each part is depreciated separately. Residual values, useful lives and the depreciation method are reviewed, and adjusted if appropriate, at least at each quarter end.

An item of property, plant and equipment including any significant part initially recognized is derecognized upon disposal or when no future economic benefits are expected from its use or disposal. Any gain or loss on disposal or retirement recognized in the statement of operations in the period the asset is derecognized is the difference between the net sales proceeds and the carrying amount of the relevant asset.

#### ***Intangible assets, net***

Intangible assets acquired separately are measured on initial recognition at cost. The cost of intangible assets acquired in a business combination is the fair value at the date of acquisition. The useful lives of intangible assets are assessed to be either finite or indefinite. Intangible assets with finite lives are amortized over the

useful economic life and assessed for impairment whenever there is an indication that the intangible asset may be impaired. The amortization period and the amortization method for an intangible asset with a finite useful life is reviewed for appropriateness at each financial year end.

Intangible assets with indefinite useful lives or not yet available for use are tested for impairment annually either individually or at the cash-generating unit level. Such intangible assets, including vaccine licenses and patents with indefinite useful lives, are not amortized. The useful life of an intangible asset with an indefinite life is reviewed annually to determine whether the indefinite life assessment continues to be supportable. If not, the change in the useful life assessment from indefinite to finite is accounted for on a prospective basis.

Patents with definite useful lives are stated at cost less any impairment losses and are amortized on the straight-line basis over their estimated useful lives of 15 years. Software and laboratory information systems are amortized on the straight-line basis over their estimated useful lives of 10 years.

An intangible asset that is determined to have an indefinite useful life is not amortized until its useful life is determined to be no longer indefinite. Management evaluates the remaining useful life of an intangible asset that is not being amortized in each reporting period to determine whether events and circumstances continue to support an indefinite useful life. Indefinite-lived intangible assets are subject to impairment testing at least annually.

Management believes that YS Group's vaccine registration certificate that was granted by the Liaoning Food and Drug Administration ("FDA") is an intangible asset with an indefinite useful life because the certificate may be renewed indefinitely at little cost and has historically been renewed by Liaoning Yisheng. Liaoning Yisheng intends to renew the certificate indefinitely, and has the ability to do so. Cash flows from the certificate are expected to continue indefinitely. Therefore, the vaccine registration certificate is not amortized until its estimated useful life is believed to be no longer indefinite.

All research and development costs are expensed incurred. Expenditure incurred on projects to develop new products is capitalized and deferred only when YS Group can demonstrate the technical feasibility of completing the intangible asset so that it will be available for use or sale, its intention to complete and its ability to use or sell the asset, how the asset will generate future economic benefits, the availability of resources to complete the project and the ability to measure reliably the expenditure during the development. Product development expenditure which does not meet these criteria is expensed when incurred.

Land use rights: Prepaid land lease payments represent amounts paid for the rights to use land in the PRC and is recorded net of accumulated amortization. Amortization is provided on a straight-line basis over the term of the lease agreement, which ranges from 48.75 to 50 years.

#### ***Impairment of Long-lived Assets***

YS Group reviews long-lived assets, including definitive-lived intangible assets and property and equipment, for impairment whenever events or changes in circumstances indicate the carrying amount of an asset may not be recoverable. When such events occur, YS Group assesses the recoverability of the asset group based on the undiscounted future cash flows the asset group is expected to generate and recognizes an impairment loss when estimated undiscounted future cash flows expected to result from the use of the asset group plus net proceeds expected from disposition of the asset group, if any, is less than the carrying value of the asset group. If YS Group identifies an impairment, YS Group reduces the carrying amount of the asset group to its estimated fair value based on a discounted cash flow approach or, when available and appropriate, to comparable market values and the impairment loss, if any, is recognized in general and administrative expenses in the consolidated statements of operations. YS Group uses estimates and judgments in its impairment tests and if different estimates or judgments had been utilized, the timing or the amount of any impairment charges could be different. Asset groups to be disposed of would be reported at the lower of the carrying amount or fair value less costs to sell, and no longer depreciated. YS Group did not record any impairment charges during the six months ended September 30, 2022 or during the fiscal year ended March 31, 2022.

#### ***Concentrations of Credit Risk and Significant Suppliers***

Financial instruments that potentially subject YS Group to concentration of credit risk consist of cash. YS Group mitigates this risk by maintaining its cash with high quality, accredited financial institutions. As of

September 30, 2022, YS Group's cash was deposited at more than two financial institutions and it did not have any foreign currency exchange contracts, option contracts or other hedging arrangements. YS Group has not experienced any losses on its deposits of cash and does not believe that it is exposed to any unusual credit risk beyond the normal credit risk associated with commercial banking relationships.

YS Group's sales are made primarily to Centers for Disease Control and Prevention ("CDCs") located in China. YS Group does not have a concentration of its revenue and accounts receivable with specific customers. As of September 30, 2022 and 2021, there was no customer which accounted for more than 10% of YS Group's accounts receivable balance. During the six months ended September 30, 2022 and 2021, there was no customer that accounted for more than 10% of YS Group's net revenues.

Details of percentage of YS Group's top 5 vendors accounting for total purchases are as follows:

	Six Months Ended September 30, 2022		
	(RMB)	(\$)	
	(Unaudited)	(Unaudited)	
Vendor A	21,661,500	\$3,051,001	38.8%
Vendor B	10,053,600	1,416,040	18.0%
Vendor C	3,005,828	423,368	5.4%
Vendor D	2,009,315	283,010	3.6%
Vendor I	1,859,500	261,909	3.3%
<b>Total</b>	<b>38,589,743</b>	<b>\$5,435,328</b>	<b>69.1%</b>

	Six Months Ended September 30, 2021		
	(RMB)	(\$)	
	(Unaudited)	(Unaudited)	
Vendor A	11,283,000	\$1,589,200	12.5%
Vendor F	9,028,170	1,271,609	10.0%
Vendor D	6,689,566	942,219	7.4%
Vendor G	6,063,000	853,968	6.7%
Vendor H	5,460,000	769,036	6.1%
<b>Total</b>	<b>38,523,736</b>	<b>\$5,426,032</b>	<b>42.7%</b>

YS Group's business operation has been, and may continue to be, negatively affected by the outbreak of COVID-19. While many of the restrictions on movements within China have been relaxed, there is great uncertainty around the future of the COVID — 19 outbreak and how it will impact YS Group's operations, particularly in terms of the spread of Omicron virus in China.

#### ***Fair Value Measurements***

ASC 825-10 requires certain disclosures regarding the fair value of financial instruments. Fair value is defined as the price that would be received to sell an asset or paid to transfer a liability in an orderly transaction between market participants at the measurement date. A three-level fair value hierarchy prioritizes the inputs used to measure fair value. The hierarchy requires entities to maximize the use of observable inputs and minimize the use of unobservable inputs. The three levels of inputs used to measure fair value are as follows:

- Level 1 — inputs to the valuation methodology are quoted prices (unadjusted) for identical assets or liabilities in active markets.
- Level 2 — inputs to the valuation methodology include quoted prices for similar assets and liabilities in active markets, quoted market prices for identical or similar assets in markets that are not active, inputs other than quoted prices that are observable and inputs derived from or corroborated by observable market data.
- Level 3 — inputs to the valuation methodology are unobservable.

Unless otherwise disclosed, the fair value of YS Group's financial instruments including cash, accounts receivable, advances to suppliers, amounts due from related parties, prepaid expenses and other current assets, short-term bank loans and other loans, accounts payable, and accrued expenses and other current liabilities approximate their recorded values due to their short-term maturities. The fair value of longer-term leases approximates their recorded values as their stated interest rates approximate the rates currently available.

YS Group's non-financial assets, such as property and equipment would be measured at fair value only if they were determined to be impaired.

#### ***Social Security Insurance***

Employees of YS Group's subsidiaries that operate in the PRC are required to participate in a central pension scheme operated by the local municipal government. According to the Social Insurance Law of the PRC (the "Social Security Insurance Law") promulgated by the Standing Committee of the National People's Congress (the "Standing Committee") that became effective on December 29, 2018, there are five basic types of social security insurance, which include basic pension insurance, basic medical insurance, unemployment insurance, work-related injury insurance and maternity insurance (collectively known as "Social Security Insurance"). Both employees and employers make contributions for the first three kinds of the social security insurances; and only employers make contributions for the latter two kinds, which means the employers must pay all or a portion of the social insurance premiums for their employees. If YS Group does not fully comply with the relevant requirements and does not make social insurance contributions in full to the social insurance scheme for the employees of PRC affiliated entities, YS Group will be required to make up the social insurance contributions as well as to pay late fees at the rate of 0.05% per day of the outstanding amount from the due date. If YS Group fails to make up for the shortfalls within the prescribed time limit, the relevant administrative authorities could impose a fine of one to three times the outstanding amount and file applications to competent courts for compulsory enforcement of payment and deposit. There was no fine or compulsory enforcement incurred by relevant authorities in connection with the delayed payment of YS Group. As of September 30, 2022 and March 31, 2022 (audited), YS Group's had recorded late fee of RMB9.7 million and RMB9.5 million, respectively for its liabilities for social security insurance (see Note 12). During six months ended September 30, 2022 and 2021, YS Group's recognized late fees related to social security insurance of approximately, RMB0.3 million and RMB1.4 million, respectively.

#### ***Leases***

Under ASC Topic 842, Leases ("ASC 842"), YS Group determines if an arrangement is or contains a lease at inception. For leases with a term of 12 months or less, YS Group does not recognize a right-of-use ("ROU") asset or lease liability. YS Group's operating leases are recognized on its consolidated balance sheets as noncurrent assets, current liabilities and noncurrent liabilities. YS Group does not have any finance leases.

ROU assets represent YS Group's ROU an underlying asset for the lease term and lease liabilities represent YS Group's obligation to make lease payments arising from the lease. Operating lease ROU assets and liabilities are recognized at the lease commencement date based on the present value of lease payments over the lease term. As YS Group's leases typically do not provide an implicit rate, YS Group uses an estimate of its incremental borrowing rate based on the information available at the lease commencement date in determining the present value of lease payments. The lease terms may include options to extend or terminate the lease when it is reasonably certain that YS Group will exercise that option. Lease expense is recognized on a straight-line basis over the lease term. For leases with terms greater than 12 months, YS Group records the related asset and lease liability at the present value of lease payments over the lease term. For leases with terms less than 12 months, YS Group records rents in administrative expenses.

#### ***Government Grants***

Government grants represent primarily subsidies received from PRC governments for operating a business in their jurisdictions and in compliance with specific policies promoted by the government authorities. YS Group's PRC-based subsidiaries received specific subsidies and other subsidies from certain local governments. Specific subsidies are subsidies the local government set certain conditions. Other subsidies are subsidies the local government has not set any conditions and are not tied to future trends or performance of YS Group, receipt of such subsidy is not contingent upon any further actions or performance of YS Group and the



amounts do not have to be refunded under any circumstances. Specific subsidies are recorded as deferred government grants upon receipt and are recognized as government grants recognized in income when the conditions are met. Other subsidies are recognized as other income upon receipt as further performance by YS Group is not required.

Government grants for research and development (“R&D”) are recognized as a reduction to R&D expenses when the conditions attached to the grants are met or recognized as government grants recognized in income in the period when the conditions are met after the expenses are incurred. Government grants for property, plant and equipment are deferred and recognized as a reduction to the related depreciation and amortization expenses in the same manner as the property, plant and equipment are depreciated.

#### ***Convertible Redeemable Preferred Shares***

YS Group has 2 classes of preferred shares: Series A and Series B with Series A consists of Series A and Series A-1 (collectively, the “Convertible Redeemable Preferred Shares”). These Convertible Redeemable Preferred Shares are considered “probable of becoming redeemable” as one of the redemption events depends solely on the passage of time, and the shares become redeemable following the respective anniversary of the issuance date.

Since the Series A, Series A-1 and Series B Preferred Shares are redeemable at a determinable price on a determinable date, at the option of the holder, or upon occurrence of an event that depends solely on the passage of time, the Series A, they are accounted for as mezzanine equity on the consolidated balance sheets.

The mezzanine equity is carried at the higher of (1) the carrying amount after the attribution of net income of YS Group or (2) the expected redemption value. YS Group accretes the difference between the initial carrying value and the ultimate redemption price using the effective interest rate method from the issuance dates to the earliest possible redemption date.

#### ***Revenue from Contracts with Customers***

YS Group follows ASC 606 — “Revenue from Contracts with Customers” for all periods presented. ASC 606 established principles for reporting information about the nature, amount, timing, and uncertainty of revenue and cash flows arising from our contracts to provide services to customers. Based on the following five steps analysis, revenues from contracts with customers are recognized when control of the promised goods or services is transferred to the customers, in an amount that reflects the consideration YS Group expects to be entitled in exchange for those goods or services.

Step 1: Identify the contract with the customer;

Step 2: Identify the performance obligations in the contract;

Step 3: Determine the transaction price;

Step 4: Allocate the transaction price to the performance obligations in the contract; and

Step 5: Recognize revenue when YS Group satisfies a performance obligation

YS Group is principally engaged in the research, development, manufacturing and sale of vaccines and therapeutic biologics. YS Group’s revenues primarily are from sales of vaccines. The core principle underlying the revenue recognition ASC 606 is that YS Group recognizes revenue to represent the transfer of vaccines to customers in an amount that reflects the consideration to which YS Group expects to be entitled in such exchange. This requires YS Group to identify contractual performance obligations and determine whether revenue should be recognized at a point in time or over time. YS Group’s sales contracts of vaccines have one single performance obligation that is to sell vaccines to the customers. The sales contracts with customers do not involve variable considerations, such as discounts and rebates. And according to the historical operation, circumstance of discounts and rebates have never occurred. The customer pays after acceptance of the vaccines. According to ASC 606, the relevant revenue recognition is based on a point in time of customer acceptance confirmation.

In accordance with ASC606-10-55-36 through 55-40, YS Group evaluates whether it is appropriate to record the gross amount of vaccines and related costs or the net amount earned as commissions. When the entity is a principal, that the entity obtains control of the specified goods or services before they are transferred to the customers, the revenues should be recognized in the gross amount of consideration to which it expects to be entitled in exchange for the specified goods or services transferred. When the entity is an agent and its obligation is to facilitate third parties in fulfilling their performance obligation for specified goods or services, the revenues should be recognized in the net amount for the amount of commission which the entity earns in exchange for arranging for the specified goods or services to be provided by other parties. Revenues are recorded net of value-added taxes. YS Group sells vaccines to the customers, and it obtains control of the vaccines before customer acceptance confirmation. Therefore, YS Group is a principal, and the revenues are recognized according to the gross method.

#### ***Cost of Revenues***

Cost of revenues consists primarily of the cost of merchandise sold and write-down of slow-moving or obsolete inventories.

#### ***General and Administrative Expenses***

General and administrative expenses consist mainly of payroll and related costs for employees involved in general corporate functions, including accounting, finance, tax, legal and human resources, professional fees, and provision for bad debts, value-added taxes and other general corporate expenses as well as costs associated with the use by these functions of facilities and equipment, such as depreciation and rental expenses.

#### ***Selling Expenses***

Selling expenses consist mainly of payroll and benefits for employees involved in the sales and distribution functions, meeting/event fees, promotion fees, marketing and selling expenses that are related to events and activities at YS Group's service centers designed to promote product sales as well as operating expenses related to the service centers.

#### ***Research and development expenses***

Research and development expenses include costs directly attributable to the conduct of research and development projects, primarily consist of salaries and other employee benefits, testing and clinical trial expenses, consulting service fees, depreciation and amortization, and office and leasing expenses. All costs associated with research and development are expensed as incurred.

#### ***Other Income (Expenses), net***

Other income (expenses) consists of miscellaneous income and expenses not directly related to YS Group's core business operations. Other income primarily consists of recovery of previously written-off accounts receivable, and write-off of payment obligations that are either more than three years old or no longer justifiable. Other expenses primarily consist of late fees related to YS Group's income tax and social security insurance payment obligations, charitable donation, medical waste disposal fee and financial expenses.

From December 2013 to June 2019, because YS Group did not have a certificate of Good Manufacturing Practice, YS Group stopped its production activities and did not pay any income taxes nor social security insurance for its employees. During the six months ended September 30, 2021, YS Group accrued RMB1.4 million of late fees related to its social security insurance. During the six months ended September 30, 2022, YS Group accrued RMB0.3 million of late fees related to its social security insurance. During the six months ended September 30, 2022 and 2021, YS Group paid RMB RMB0.1 million and RMB86.2 million of late fees for social security insurance and tax, respectively.

#### ***Income Taxes***

**Cayman Islands.** Under the current laws of the Cayman Islands, YS Group is not subject to tax on income or capital gains. In addition, upon payments of dividends by YS Group to its shareholders, no Cayman Islands withholding tax is imposed.

**Hong Kong.** Under the Hong Kong tax laws, Yisheng Hong Kong is exempted from profit tax on its foreign-sourced income and there are no withholding taxes in Hong Kong on remittance of dividends.

**Singapore.** The subsidiary incorporated in Singapore files separate income tax returns in Singapore and paid Singapore statutory income tax of 17%.

**China.** Pursuant to the PRC Corporate Income Tax Law and the respective regulations, subsidiaries operating in China are subject to corporate income tax at a statutory rate of 25% on the taxable income.

**United States.** The subsidiary incorporated in Maryland, United States (“U.S.”) is subject to statutory U.S. federal corporate income tax at a rate of 21% and state income tax in Maryland at a rate of 8.25%.

Current tax assets and liabilities are measured at the amount expected to be recovered from or paid to the taxation authorities, based on tax rates (and tax laws) that have been enacted or substantively enacted by the end of the Relevant Periods, taking into consideration interpretations and practices prevailing in the countries in which YS Group operates.

Deferred tax is provided, using the liability method in accordance with ASC740, *Income Taxes* (“ASC 740”), on all temporary differences at the end of each of the Relevant Periods between the tax bases of assets and liabilities and their carrying amounts for financial reporting purposes.

Deferred tax liabilities are recognized for all taxable temporary differences, except:

- when the deferred tax liability arises from the initial recognition of goodwill or an asset or liability in a transaction that is not a business combination and, at the time of the transaction, affects neither the accounting profit nor taxable profit or loss; and
- in respect of taxable temporary differences associated with investments in subsidiaries when the timing of the reversal of the temporary differences can be controlled and it is probable that the temporary differences will not reverse in the foreseeable future.

Deferred tax assets are recognized for all deductible temporary differences, and the carryforward of unused tax credits and any unused tax losses. Deferred tax assets are recognized to the extent that it is probable that taxable profit will be available against which the deductible temporary differences, and the carryforward of unused tax credits and unused tax losses can be utilized, except:

- when the deferred tax asset relating to the deductible temporary differences arises from the initial recognition of an asset or liability in a transaction that is not a business combination and, at the time of the transaction, affects neither the accounting profit nor taxable profit or loss; and
- in respect of deductible temporary differences associated with investments in subsidiaries, deferred tax assets are only recognized to the extent that it is probable that the temporary differences will reverse in the foreseeable future and taxable profit will be available against which the temporary differences can be utilized.

The carrying amount of deferred tax assets is reviewed at the end of each reporting period and reduced to the extent it is no longer probable that sufficient taxable profit will be available to allow all or part of the deferred tax asset to be utilized.

Deferred tax assets and liabilities are measured at the tax rates that are expected to apply to the period when the asset is realized or the liability is settled, based on tax rates (and tax laws) that have been enacted or substantively enacted by the end of the Relevant Periods.

Deferred tax assets and liabilities are offset if and only if YS Group has a legally enforceable right to set off current tax assets and current tax liabilities and the deferred tax assets and deferred tax liabilities relate to income taxes levied by the same taxation authority on either the same taxable entity or different taxable entities which intend either to settle current tax liabilities and assets on a net basis, or to realize the assets and settle the liabilities simultaneously, in each future period in which significant amounts of deferred tax liabilities or assets are expected to be settled or recovered.

YS Group records a valuation allowance to offset deferred tax assets if based on the weight of available evidence, it is more-likely-than-not that some portion, or all, of the deferred tax assets will not be realized. The

effect on deferred taxes of a change in tax rate is recognized in tax expense in the period that includes the enactment date of the change in tax rate.

YS Group accounted for uncertainties in income taxes in accordance with ASC 740. Interest and penalties arising from underpayment of income taxes shall be computed in accordance with the related PRC tax law. The amount of interest expense is computed by applying the applicable statutory rate of interest to the difference between the tax position recognized and the amount previously taken or expected to be taken in a tax return. Interest and penalties recognized in accordance with ASC 740 are classified in the consolidated statements of comprehensive loss as non-operating expense.

#### ***Value Added Tax (“VAT”)***

Value-added taxes (“VAT”) collected from customers relating to product sales and remitted to governmental authorities are presented on a net basis. VAT collected from customers is excluded from revenue. The VAT payable is presented in the account of accrued expenses and other liabilities.

#### ***Taxes other than Income Tax***

Under the PRC Tax Law, taxes other than income tax primarily include additional tax calculated based on value-added tax payable, individual income tax, property tax, etc.

#### ***Share-based Compensation***

YS Group operates a share option scheme for the purpose of providing incentives and rewards to eligible participants who contribute to the success of YS Group’s operations. Employees (including directors) of Company receive granted shares and share options in the form of share-based payments, whereby employees render services as consideration for equity instruments (“equity-settled transactions”).

The cost of equity-settled transactions with employees for grants is measured by reference to the fair value of the equity instruments at the date when they are granted. The fair value is determined by an external valuer using a binomial model. The cost of equity-settled transactions is recognized in employee benefit expense, together with a corresponding increase in equity, over the period in which the performance and/or service conditions are fulfilled.

The cumulative expense recognized for equity-settled transactions at the end of each of the periods until the vesting date reflects the extent to which the vesting period has expired and YS Group’s best estimate of the number of equity instruments that will ultimately vest. The charge or credit to the statement of profit or loss for a period represents the movement in the cumulative expense recognized as at the beginning and end of that period. Service and non-market performance conditions are not taken into account when determining the grant date fair value of awards, but the likelihood of the conditions being met is assessed as part of the YS Group’s best estimate of the number of equity instruments that will ultimately vest. Market performance conditions are reflected within the grant date fair value. Any other conditions attached to an award, but without an associated service requirement, are considered to be non-vesting conditions. Non-vesting conditions are reflected in the fair value of an award and lead to an immediate expensing of an award unless there are also service and/or performance conditions.

For awards that do not ultimately vest because non-market performance and/or service conditions have not been met, no expense is recognized. Where awards include a market or non-vesting condition, the transactions are treated as vesting irrespective of whether the market or non-vesting condition is satisfied, provided that all other performance and/or service conditions are satisfied.

Where the terms of an equity-settled award are modified, as a minimum an expense is recognized as if the terms had not been modified, if the original terms of the award are met. In addition, an expense is recognized for any modification that increases the total fair value of the share-based payments, or is otherwise beneficial to the employee as measured at the date of modification.

Where an equity-settled award is cancelled, it is treated as if it had vested on the date of cancellation, and any expense not yet recognized for the award is recognized immediately. This includes any award where non-vesting conditions within the control of either the YS Group or the employee are not met. However, if a new

award is substituted for the cancelled award, and is designated as a replacement award on the date that it is granted, the cancelled and new awards are treated as if they were a modification of the original award, as described in the previous paragraph.

### ***Comprehensive Loss***

Comprehensive loss consists of two components, net loss and other comprehensive income (loss). Other comprehensive income (loss) consists of foreign currency translation adjustment from YS Group not using RMB as its functional currency.

### ***Shareholders' Contribution***

Main sources of shareholders' contribution include debt forgiveness from related parties and cash donations from shareholders.

### ***Loss Per Share***

In accordance with ASC 260, Earnings Per Share, basic loss per share is computed by dividing net loss attributable to ordinary shareholders by the weighted average number of ordinary shares outstanding during the period. Diluted loss per share is calculated by dividing net loss attributable to ordinary shareholders as adjusted for the effect of dilutive ordinary equivalent shares, if any, by the weighted average number of ordinary shares plus dilutive equivalent shares outstanding during the period. Dilutive equivalent shares are excluded from the computation of diluted loss per share if their effects would be anti-dilutive. No potential common shares were included in the computation of diluted loss per share when a loss from continuing operation exists.

### ***Segment Reporting***

ASC 280, "Segment Reporting", establishes standards for reporting information about operating segments on a basis consistent with YS Group's internal organizational structure as well as information about geographical areas, business segments and major customers in the CFS for details on YS Group's business segments.

YS Group uses the management approach to determine reportable operating segments. The management approach considers the internal organization and reporting used by YS Group's chief operating decision maker ("CODM") for making decisions, allocating resources and assessing performance. YS Group's CODM has been identified as the CEO, who reviews consolidated results when making decisions about allocating resources and assessing performance of YS Group.

Based on management's assessment, YS Group has only one operating segment, which is the development, production, marketing and sale of biopharmaceutical products. No operating segments were aggregated to form the reportable operating segment.

YS Group's non-current assets are located in the PRC and other countries. The location of these non-current assets can be aggregated to form the reportable geographical segment.

### ***Significant Risks***

#### ***Currency risk***

A majority of YS Group's expenses are denominated in RMB and a significant portion of YS Group and its subsidiaries' assets and liabilities are denominated in RMB. RMB is not freely convertible into foreign currencies. In the PRC, certain foreign exchange transactions are required by law to be transacted only by authorized financial institutions at exchange rates set by the People's Bank of China ("PBOC"). Remittances in currencies other than RMB by YS Group in China must be processed through the PBOC or other Company foreign exchange regulatory bodies which require certain supporting documentation in order to affect the remittance.

YS Group's condensed total assets by geographical area and its denominated currency are shown below:

	Denominated Currency	March 31, 2022		September 30, 2022		
		(RMB)		(RMB)	(US\$)	
				(unaudited)	(unaudited)	
PRC	RMB	1,155,124,790	80%	1,316,093,351	\$185,370,484	85%
Hong Kong	\$	2,666,762	0%	194,452,627	27,388,465	13%
Singapore	S\$	26,168,621	2%	29,843,991	4,203,497	2%
United States	\$	5,181,433	0%	4,104,976	578,182	0%
Cayman	\$	252,611,535	18%	3,943,175	555,392	0%
<b>Total</b>		<b>1,441,753,141</b>	<b>100%</b>	<b>1,548,438,120</b>	<b>\$218,096,020</b>	<b>100%</b>

YS Group maintains bank accounts in the PRC. On May 1, 2015, China's new Deposit Insurance Regulation came into effect, pursuant to which banking financial institutions, such as commercial banks, established in the PRC are required to purchase deposit insurance for deposits in RMB and in foreign currency placed with them. Such Deposit Insurance Regulation would not be effective in providing complete protection for YS Group's accounts, as its aggregate deposits amount are higher than the compensation limit, which is RMB 500,000 for one bank. However, YS Group believes the risk of failure of any of these Chinese banks is remote. Bank failure is uncommon in the PRC and YS Group believes those Chinese banks that hold YS Group's cash are financially sound based on public available information.

#### *Concentration and political risk*

Currently, all of YS Group's operations are carried out in the PRC. Accordingly, YS Group's business, financial condition and results of operations may be influenced by the political, economic and legal environment in the PRC, and by the general state of the PRC's economy. YS Group's operations in the PRC are subject to specific considerations and significant risks not typically associated with companies in North America and Western Europe. YS Group's results may be adversely affected by changes in governmental policies with respect to laws and regulations, anti-inflationary measures, currency conversion and remittance abroad, and rates and methods of taxation, among other things. Although YS Group has not experienced losses from these situations and believes it is in compliance with existing laws, this may not be indicative of future results.

#### *Interest rate risk*

Fluctuations in market interest rates may negatively affect YS Group's financial condition and results of operations. YS Group is exposed to floating interest rate risk on cash deposits and floating rate borrowings, and the risks due to changes in interest rates is not material. YS Group has not used any derivative financial instruments to manage YS Group's interest risk exposure.

#### *Related Parties*

A party is considered related to YS Group if the party directly or indirectly or through one or more intermediaries, controls, is controlled by, or is under common control with YS Group. Related parties also include principal owners of YS Group, its management, members of the immediate families of principal owners of YS Group and its management and other parties with which YS Group may deal if one party controls or can significantly influence the management or operating policies of the other to an extent that one of the transacting parties might be prevented from fully pursuing its own separate interests. A party which can significantly influence the management or operating policies of the transacting parties or if it has an ownership interest in one of the transacting parties and can significantly influence the other to an extent that one or more of the transacting parties might be prevented from fully pursuing its own separate interests is also a related party.

#### *Recently Issued Accounting Pronouncements*

In June 2016, the FASB issued Accounting Standards Update ("ASU") 2016-13, Financial Instruments — Credit Losses (Topic 326). The amendments in this Update require a financial asset (or a group of financial assets) measured at amortized cost basis to be presented at the net amount expected to be

collected. The amendments broaden the information that an entity must consider in developing its expected credit loss estimate for assets measured either collectively or individually. The use of forecasted information incorporates more timely information in the estimate of expected credit loss, which will be more decision useful to users of the financial statements. This ASU is effective for annual and interim periods beginning after December 15, 2019 for issuers and December 15, 2020 for non-issuers. Early adoption is permitted for all entities for annual periods beginning after December 15, 2018, and interim periods therein. In May 2019, the FASB issued ASU 2019-05, Financial Instruments — Credit Losses (Topic 326): Targeted Transition Relief. This ASU adds optional transition relief for entities to elect the fair value option for certain financial assets previously measured at amortized cost basis to increase comparability of similar financial assets. The ASUs should be applied through a cumulative-effect adjustment to retained earnings as of the beginning of the first reporting period in which the guidance is effective (that is, a modified retrospective approach). On November 19, 2019, the FASB issued ASU 2019-10 to amend the effective date for ASU 2016-13 to be fiscal years beginning after December 15, 2022 and interim periods therein. YS Group is still evaluating the impact of accounting standard of credit losses on YS Group's CFS.

In December 2019, the FASB issued ASU 2019-12, Income Taxes (Topic 740): Simplifying the Accounting for Income Taxes, which removes certain exceptions to the general principles in Topic 740, and improves consistent application of and simplify U.S. GAAP for other areas of Topic 740 by clarifying and amending existing guidance. For public business entities, the amendments in this update are effective for fiscal years, and interim periods within those fiscal years, beginning after December 15, 2020. For all other entities, the amendments in this update are effective for fiscal years beginning after December 15, 2021, and interim periods within fiscal years beginning after December 15, 2022. Early adoption of the amendments is permitted. YS Group will adopt this ASU within annual reporting period of March 31, 2023 and expects that the adoption of this ASU will not have a material impact on YS Group's CFS

YS Group does not believe other recently issued but not yet effective accounting standards, if currently adopted, would have a material effect on YS Group's consolidated financial position, statements of Income and comprehensive income and cash flows.

#### NOTE 4—ACCOUNTS RECEIVABLE, NET

Accounts receivable consists of the followings

	March 31, 2022	September 30, 2022	September 30, 2022
	(RMB)	(RMB)	(US\$)
		(Unaudited)	(Unaudited)
Trade receivables	322,170,980	488,422,373	\$68,793,821
Allowance for doubtful accounts	(13,615,875)	(20,062,985)	(2,825,852)
<b>Accounts receivable, net</b>	<b><u>308,555,105</u></b>	<b><u>468,359,388</u></b>	<b><u>\$65,967,969</u></b>

The allowance for doubtful accounts reflects YS Group's best estimate of probable losses inherent in the accounts receivable balance. YS Group estimates the allowance based on historical experience, the age of the accounts receivable balances, credit quality of YS Group's customers, current and forecasted future economic conditions, and other factors that may affect customers' ability to pay. During the six months ended September 30, 2022 and 2021, YS Group recorded approximately RMB6.4 million and RMB2.9 million of bad debt expense, respectively.

Below is an analysis of the movements in the allowance for doubtful account:

	Six Months Ended September 30,		
	2021	2022	2022
	(RMB)	(RMB)	(\$)
	(Unaudited)	(Unaudited)	(Unaudited)
Balance at April 1,	8,530,951	13,615,875	\$1,917,783
Additions	2,888,417	6,447,110	908,069
<b>Balance at September 30</b>	<b>11,419,368</b>	<b>20,062,985</b>	<b>\$2,825,852</b>

#### NOTE 5—INVENTORIES, NET

YS Group's inventories consist of the following:

	March 31, 2022	September 30, 2022	September 30, 2022
	(RMB)	(RMB)	(\$)
		(Unaudited)	(Unaudited)
Raw materials	57,926,980	52,392,648	\$ 7,379,454
Work in progress	40,795,744	39,148,872	5,514,081
Finished goods	73,285,870	71,235,067	10,033,391
Allowance for slow-moving or obsolete inventories	(5,503,029)	(1,109,400)	(156,258)
<b>Inventories, net</b>	<b>166,505,565</b>	<b>161,667,187</b>	<b>\$22,770,668</b>

The movements in the allowance for slow-moving or obsolete inventories are as follows:

	Six Months Ended September 30,		
	2021	2022	2022
	(RMB)	(RMB)	(\$)
	(Unaudited)	(Unaudited)	(Unaudited)
Balance at April 1,	41,301,797	5,503,029	\$ 775,096
Inventories written off	(40,192,397)	(4,393,629)	(618,838)
<b>Balance at September 30</b>	<b>1,109,400</b>	<b>1,109,400</b>	<b>\$ 156,258</b>

During the six months ended September 30, 2022 and 2021, the allowance for slow-moving or obsolete inventories was nil.



**NOTE 6— PROPERTY, PLANT AND EQUIPMENT, NET**

Property, plant and equipment consist of the following:

Cost	March 31, 2022	September 30, 2022	September 30, 2022
	(RMB)	(RMB)	(\$)
		(Unaudited)	(Unaudited)
Construction in progress	318,000,074	333,446,243	\$ 46,965,583
Plant and buildings	170,206,987	183,372,813	25,827,884
Machinery and equipment	194,875,303	193,846,868	27,303,145
Electronic equipment	10,107,578	10,794,907	1,520,452
Motor vehicles	2,978,155	3,027,767	426,458
Office equipment and furniture	29,888,526	21,612,891	3,044,155
Leasehold improvements	4,390,980	4,626,927	651,698
<b>Total Cost</b>	<b>730,447,603</b>	<b>750,728,416</b>	<b>105,739,375</b>
Less: accumulated depreciation	(150,402,597)	(163,469,667)	(23,024,545)
Less: asset impairment	(29,891,896)	(29,891,896)	(4,210,245)
<b>Property and equipment, net</b>	<b>550,153,110</b>	<b>557,366,853</b>	<b>\$ 78,504,585</b>

There are no events or changes in circumstances that indicate the carrying amount of an asset may not be fully recoverable by comparing the carrying amount of the assets to the future undiscounted cash flows expected to result from the use of the assets and their eventual disposition.

**NOTE 7— PREPAID EXPENSES AND OTHER CURRENT ASSETS**

	March 31, 2022	September 30, 2022	September 30, 2022
	(RMB)	(RMB)	(\$)
		(Unaudited)	(Unaudited)
Deposits <sup>(1)</sup>	2,807,847	1,622,616	\$228,544
Staff advances <sup>(2)</sup>	383,251	303,767	42,785
Staff's social security <sup>(3)</sup>	615,581	677,626	95,443
Value added tax recoverable <sup>(4)</sup>	3,442,733	3,920,265	552,166
Other receivable <sup>(5)</sup>	854,245	534,169	75,237
Allowance <sup>(6)</sup>	(115,743)	(115,743)	(16,302)
<b>Total</b>	<b>7,987,914</b>	<b>6,942,700</b>	<b>\$977,873</b>

- (1) Deposits primarily represented deposits to Centers for Disease Control and Prevention (“CDCs”) in connection with participation in the public tender process held by province-level CDCs.
- (2) Staff advances primarily represented cash advances paid to employees in advance of their expected business travel or in connection with various expense incurred in the ordinary course of business, such as sales and marketing activities.
- (3) Staff social security primarily represented the portion of the government mandated defined contribution plan that should be made by employees. But this portion should be paid to the government by YS Group on behalf of the employees pursuant to PRC labor regulation. When YS Group pays wages to employees, this portion should be deducted accordingly.
- (4) Value-added taxes (“VAT”) includes input tax on purchase and output tax on sales. VAT collected from customers relating to product sales and remitted to governmental authorities is presented on a net basis, and it is excluded from revenue. YS Group is in a net VAT recoverable position when its input tax on purchase in the current year is greater than the output tax on sales. Such net amount can be deducted in the following years.
- (5) Other receivable primarily consists of prepayment to third parties, such as freight, water and electricity, and promotion fees.
- (6) The allowance reflects YS Group’s best estimate of probable amounts not fully recoverable from the other receivables balance. Due to the fact that some employees resigned and lost contact, the cash paid to them in advance of their expected business travel or in connection with various expense incurred in the ordinary course of business might not be recovered.

**NOTE 8—INTANGIBLE ASSETS, NET**

YS Group's intangible assets are presented below:

	March 31, 2022	September 30, 2022	September 30, 2022
	(RMB)	(RMB)	(\$)
		(Unaudited)	(Unaudited)
<b>Cost</b>			
Patents	79,608,000	79,608,000	\$ 11,212,710
Licenses, software and laboratory information system	6,143,880	10,150,478	1,429,685
Land use rights	67,181,860	67,181,860	9,462,500
<b>Total Cost</b>	<b>152,933,740</b>	<b>156,940,338</b>	<b>22,104,895</b>
<b>Less: Accumulated Amortization</b>	<b>(72,215,762)</b>	<b>(75,625,405)</b>	<b>(10,651,765)</b>
<b>Intangible Assets, net</b>	<b>80,717,978</b>	<b>81,314,933</b>	<b>\$ 11,453,130</b>

**NOTE 9—BANK LOANS AND OTHER BORROWINGS**

	March 31, 2022	September 30, 2022	September 30, 2022	Maturity Date	Interest Rate
	(RMB)	(RMB)	(\$)		
		(Unaudited)	(Unaudited)		
China Guangfa Bank Co., Ltd. – Shenyang Branch <sup>(1)</sup>	46,456,142	35,509,492	\$ 5,001,478	2022/11/17 – 2022/12/16	5.66%
Shanghai Pudong Development Bank Co., Ltd. Shenyang Branch <sup>(2)</sup>	64,647,870	81,486,261	11,477,261	2022/10/11 – 2023/09/22	5.30%
Citi Bank <sup>(3)</sup>	234,743	—	—	2022/5/1	1.00%
R-Bridge Healthcare Fund, LP <sup>(4)</sup>	394,999	—	—	2026/9/15	4.00%
China Citic Bank – Shenyang Branch <sup>(5)</sup>	—	34,295,325	4,830,464	2023/3/16 – 2023/5/19	5.2% / 3.25%
China Construction Bank – Shenyang Branch <sup>(6)</sup>	—	12,350,000	1,739,485	2023/9/8 – 2023/9/27	4.00%
<b>Bank loans due within one year</b>	<b>111,733,754</b>	<b>163,641,078</b>	<b>\$23,048,688</b>		
R-Bridge Healthcare Fund, LP <sup>(4)</sup>	253,928,000	283,992,000	40,000,000	2026/9/15	4.00%
<b>Long-term bank loans</b>	<b>253,928,000</b>	<b>283,992,000</b>	<b>40,000,000</b>		
<b>Total bank loans</b>	<b>365,661,754</b>	<b>447,633,078</b>	<b>\$63,048,688</b>		

- (1) On September 13, 2021, YS Group entered into a credit facility of RMB 100 million with China Guangfa Bank Co., Ltd. Shenyang Branch for three years to finance its working capital requirements. YS Group repaid approximately RMB10.9 million on September 16, 2022 and drew approximately RMB 35.5 million from November 22, 2021 to March 10, 2022 with interest at 5.65%, which is due from November 17, 2022 to December 16, 2022.
- (2) On July 12, 2021, YS Group entered into a credit facility of RMB 140 million with Shanghai Pudong Development Bank Co., Ltd. Shenyang Branch for three years to finance its working capital requirements. On July 8, 2022, YS Group entered into another credit facility of RMB 15 million with Shanghai Pudong Development Bank Co., Ltd. for two years to finance its working capital requirements. YS Group repaid about RMB39.0 million from July 19, 2022 to September 26, 2022 and drew approximately RMB 55.9 million from May 12, 2022 to September 23, 2022 with interest at 5.3%.
- (3) On May 2, 2020, YS Group borrowed RMB1,103,609 (US\$166,400) with interest at 1.00% from Citi Bank. The loan was due on May 1, 2022. The balance of RMB234,742 (\$36,978) was repaid in full in May 2022.
- (4) On March 16, 2022, YS Group entered into a facility agreement with R-Bridge Healthcare Fund, LP, as agent, to finance RMB 253,928,000 (\$40,000,000) for 54 months with interest at 4%. YS Group shall repay the loan in instalments by repaying on each Repayment Date which means the fifth business day after each financial quarter date an amount equal to the relevant percentage of the aggregate outstanding principal amount of the loan as at the end of the Availability Period as set out in the table below:

Repayment Date	Repayment Instalment
April 7, 2025	\$ 6,400,000
July 7, 2025	6,400,000
October 7, 2025	6,400,000
January 7, 2026	6,400,000
April 7, 2026	6,400,000
July 7, 2026	8,000,000
<b>Total</b>	<b>\$40,000,000</b>

Under the terms of the Facility Agreement, YS Group and Agent also entered into a Deed, pursuant to which YS Group will pay to agent, the royalties on the products as contingent interest in addition to the payments made to agent under the facility agreement, on the terms and subject to the conditions of the Deed. YS Group is obliged to pay royalties to such agent as contingent interest for the facility based upon YS Group's annual net sales of rabies vaccines by multiplying the royalty rate from 1.5% to 3.5% by the corresponding amount incremental net sales for that financial year.

YS Group shall pay accrued interest on the Loan on each payment date. For the six months ended September 30, 2022, YS Group accrued approximately RMB11.4 million (\$1.7 million) of interest expenses and royalty fee.

- (5) On May 25, 2022, YS Group entered into a credit facility of RMB30 million with China CITIC Bank and Industrial Bank for one year to finance its working capital requirements. YS Group drew about RMB 29.3 million from May 12, 2022 to July 22, 2022 with interest at 5.2%. And YS Group Also entered into a letter of credit facility of RMB5 million with interest of 3.25%.
- (6) On September 6, 2022, YS Group entered into a credit facility of RMB50 million with China Construction Bank for one year to finance its working capital requirements. YS Group drew approximately RMB 12.4 million from September 9, 2022 to September 28, 2022 with interest at 4 %.

In addition, on March 5, 2021, YS Group entered into a credit facility of RMB 250 million with China CITIC Bank for three years to finance its working capital requirements. On September 7, 2021, YS Group entered into another credit facility of RMB 250 million with China CITIC Bank for three years to finance its working capital requirements. YS Group has not drawn any amounts from these two facilities as of date of this report. These two credit facilities are due to expire on March 4, 2024 and September 6, 2024, respectively. On April 13, 2022, YS Group entered into credit facility of RMB 70 million with China Everbright Bank for one year to finance its working capital requirements. YS Group has not drawn any amounts from this facility as of date of this report. The credit facility is due to expire on April 13, 2023.

YS Group recorded RMB 15.2 million and RMB 0.4million of interest expense for the six months ended September 30, 2022 and 2021, respectively.

#### NOTE 10—LEASES

A summary of YS Group's operating leases as of March 31, 2022 and September 30, 2022 is as follows:

	March 31, 2022	September 30, 2022	September 30, 2022
	(RMB)	(RMB)	(\$)
		(Unaudited)	(Unaudited)
Operating lease ROU assets	14,850,283	13,067,129	\$1,840,493
Operating lease liabilities – current	4,322,252	3,524,558	496,431
Operating lease liabilities – non-current	10,605,260	10,403,843	\$1,465,371
Weighted average remaining lease term	3.4	3.0	3.0
Weighted average discount rate	4.8%	4.8%	4.8%

A summary of lease cost recognized in YS Group's CFS and supplemental cash flow information related to operating leases is as follows:

	Six Months Ended September 30,		
	2021	2022	2022
	(RMB)	(RMB)	(\$)
		(Unaudited)	(Unaudited)
Operating lease cost	2,237,633	2,508,388	\$373,050
Cash paid for operating leases	<u>2,276,956</u>	<u>786,888</u>	<u>\$110,832</u>

YS Group entered into an agreement of rent reduction from June 2022 to December 2022 for total amount RMB2,068,108. And YS Group recognized the rent reduction as a deduction of operating lease cost for RMB988,303 in the six months ended September 30, 2022.

A summary of maturity of operating lease liabilities under the YS Group's non-cancelable operating leases as of September 30, 2022 is as follows:

12 months Ending September 30,	As of September 30, 2022	
	(RMB)	(\$)
2023	5,748,070	\$ 809,610
2024	5,029,426	708,390
2025	3,921,138	552,289
2026	158,029	22,257
<b>Total lease payments</b>	<b>14,856,663</b>	<b>2,092,546</b>
Less: Interest	(928,262)	(130,744)
<b>Present value of operating lease liabilities</b>	<b>13,928,401</b>	<b>\$1,961,802</b>
Operating lease liabilities – current	3,524,558	496,431
Operating lease liabilities – non-current	<u>10,403,843</u>	<u>\$1,465,371</u>

#### NOTE 11 — ACCRUED EXPENSES AND OTHER CURRENT LIABILITIES

Accrued expenses and other current liabilities are consisted of the following:

	March 31, 2022	September 30, 2022	September 30, 2022
	(RMB)	(RMB)	(\$)
		(Unaudited)	(Unaudited)
Salaries and social security insurance payable <sup>(1)</sup>	57,459,273	55,943,773	\$ 7,879,627
Promotion service fee <sup>(2)</sup>	64,883,477	93,688,809	13,195,979
Taxes other than income tax	1,171,381	3,005,157	423,273
Late fees <sup>(3)</sup>	9,499,595	9,685,430	1,364,183
Payable for property, plant and equipment	48,774,134	49,128,153	6,919,653
CDC transportation and storage fee	35,023,095	48,656,533	6,853,226
Guarantee deposits <sup>(4)</sup>	94,528,659	94,733,524	13,343,126
Professional service fee <sup>(5)</sup>	7,758,448	2,226,221	313,561
Other payable <sup>(6)</sup>	7,653,291	10,215,721	1,438,874
<b>Total</b>	<b>326,751,353</b>	<b>367,283,321</b>	<b>\$51,731,502</b>

(1) This payable includes primarily unpaid salaries and outstanding social security insurance. During the six months ended September 30, 2022, YS Group paid approximately RMB1.5 million to reduce its payable related to salaries, social security insurance. Salaries and social security insurance payables are consisted of the following:

	<u>March 31, 2022</u>	<u>September 30, 2022</u>	<u>September 30, 2022</u>
	<u>(RMB)</u>	<u>(RMB)</u>	<u>(\$)</u>
		<u>(Unaudited)</u>	<u>(Unaudited)</u>
Salaries	49,020,045	47,732,121	\$6,723,023
Social security insurance	7,732,161	7,535,447	1,061,360
Union Fee	707,067	676,205	95,244
<b>Total</b>	<b><u>57,459,273</u></b>	<b><u>55,943,773</u></b>	<b><u>\$7,879,627</u></b>

- (2) Promotion service fee primarily are fees for vaccine promotion, including design and implementation of academic activities, and collection of market information.
- (3) Late fees primarily represent late fees related to corporate income tax, taxes other than income tax, social security insurance and housing reserve fund contributions because YS Group failed to pay the income tax for the period from calendar 2011 to calendar 2013, taxes other than income tax for the period from calendar 2014 to the beginning of calendar 2021 and social security insurance for the period from calendar 2015 to the beginning of calendar 2021. As of June, 2021, YS Group has fully paid the unpaid taxes, including income tax and other taxes other than income tax, as well as the late fees charge of them. During the six months ended September 30, 2022, the late fee is incurred from unpaid social insurance. The late fees consisted of the following:

	<u>March 31, 2022</u>	<u>September 30, 2022</u>	<u>September 30, 2022</u>
	<u>(RMB)</u>	<u>(RMB)</u>	<u>(\$)</u>
		<u>(Unaudited)</u>	<u>(Unaudited)</u>
Late fee charge of social insurance	9,499,595	9,685,430	1,364,183
<b>Total</b>	<b><u>9,499,595</u></b>	<b><u>9,685,430</u></b>	<b><u>\$1,364,183</u></b>

- (4) Guarantee deposits primarily represented refundable deposits paid to YS Group by external service providers as a measurement to guarantee us that external service providers will provide us with high quality and reasonable professional services. Their professional service scope includes conducting market research and analysis, monitoring product clinical information, collecting and reporting adverse events of the product use, providing academic visits and education seminars, assisting product shipment and payment collections. Their services don't assume inventory risk for the vaccines before they are transferred to the end customers.
- (5) Professional service fees primarily represented service fees from professional advisor.
- (6) Other payable primarily represented employees' reimbursement and value added tax and the royalty fee to R-Bridge Healthcare Fund, L.P. (See note 10)

## NOTE 12 — CONVERTIBLE REDEEMABLE PREFERRED SHARES

YS Group has two classes of preferred shares: Series A and Series B (collectively, the "Convertible Redeemable Preferred Shares") with Series A consists of Series A and A-1. These Convertible Redeemable Preferred Shares are classified outside of the shareholders' equity section of YS Group's consolidated balance sheets because these shares contain deemed liquidation rights that are a contingent redemption feature not solely within the control of YS Group.

### *Series A*

On December 10, 2012, pursuant to the Series A redeemable convertible preferred share purchase agreement and shareholders agreement ("Preferred Shares Agreements"), YS Biopharma issued 21,548,589 Series A redeemable convertible preferred shares ("Series A Preferred Share") to Asia Ventures II L.P., and Beacon Bioventures Fund III Limited Partnership (renamed as "F-Prime Capital Partners Healthcare Fund III LP" on December 30, 2015), collectively with any of their respective affiliates who holds Series A Preferred Shares, at \$0.93 per share for total cash consideration of \$20,000,000, of which 6,014,313 shares of Series A were transferred as Series A-1 on September 4, 2020.

### *Series A-1*

On September 4, 2020, pursuant to the share purchase agreement entered into by and among Asia Ventures II L.P., ("Asia Ventures"), F-Prime Capital Partners Healthcare Fund III LP("F-Prime") and Haitong XuYu International Limited, Epiphron Capital (Hong Kong) Limited, 3W Global Investment Limited, OrbiMed New Horizons Master Fund, L.P. and HH SUM XXXVI Holdings Limited (collectively "Purchasers"), Asia Ventures and F-Prime transferred 6,014,313 Series A Preferred Shares to the Purchasers. As of September 30, 2022, 15,534,276 shares Series A and 6,014,313 shares Series A-1 were issued and outstanding.

For the six months ended September 30, 2022, there were no new Series A preferred shares issued, and the accretion to redemption value was RMB 36,647,950.

### Series B

In January 2021, the principal amount of Convertible Notes together with the accrued interest of US \$20,389,315 were converted into 18,393,610 Series B Preferred Shares at US \$1.1085 per share, and the convertible note holders also exercised their call option rights under the Convertible Notes and converted into 9,660,324 Series B preferred shares at US \$2.0703 per share.

In January 2021, YS Group raised US \$88,000,000 by way of issuance of 36,129,245 Series B Preferred Shares to Oceanpine Investment Fund II LP, AIHC Master Fund, 3W Global Fund (together with 3W Global Investment Limited, the “3W Global”), MSA Growth Fund II, L.P., Epiphron Capital (Hong Kong) Limited, Wudaokou Capital Limited and Gennex China Growth Fund.

In February 2021, YS Group raised US \$3,000,000 by way of issuance of 1,231,679 Series B Preferred Shares to Superstring Capital Master Fund LP.

For the six months ended September 30, 2022, there were no new Series B preferred shares issued, and the accretion to redemption value was RMB 35,435,288.

The following table summarizes YS Group’s outstanding Convertible Redeemable Preferred Shares as of September 30, 2022:

	Series A		Series A-1		Series B	Total	Total	
	Shares	Carrying Value (RMB)	Shares	Carrying Value (RMB)	Carrying Value (RMB)	Carrying Value (RMB)	Carrying Value (\$)	
<b>As of March 31, 2021</b>	<b>15,534,276</b>	<b>344,661,893</b>	<b>6,014,313</b>	<b>65,665,315</b>	<b>65,414,858</b>	<b>875,131,363</b>	<b>1,285,458,571</b>	<b>\$181,055,603</b>
Accretion to redemption value	—	28,042,858	—	2,566,412	—	34,404,481	65,013,751	9,157,124
Foreign currency translation adjustment	—	(4,690,126)	—	(875,280)	—	(11,666,321)	(17,231,727)	(2,427,072)
<b>As of September 30, 2021</b>	<b>15,534,276</b>	<b>368,014,625</b>	<b>6,014,313</b>	<b>67,356,447</b>	<b>65,414,858</b>	<b>897,869,523</b>	<b>1,333,240,595</b>	<b>\$187,785,655</b>
<b>As of March 31, 2022</b>	<b>15,534,276</b>	<b>389,563,659</b>	<b>6,014,313</b>	<b>68,510,809</b>	<b>65,414,858</b>	<b>912,146,924</b>	<b>1,370,221,392</b>	<b>\$192,994,365</b>
Accretion to redemption value	—	33,793,180	—	2,854,770	—	35,435,288	72,083,238	10,152,855
Foreign currency translation adjustment	—	48,011,366	—	8,270,941	—	109,974,790	166,257,097	23,417,151
<b>As of September 30, 2022</b>	<b>15,534,276</b>	<b>471,368,205</b>	<b>6,014,313</b>	<b>79,636,520</b>	<b>65,414,858</b>	<b>1,057,557,002</b>	<b>1,608,561,727</b>	<b>\$226,564,371</b>

### Convertible Preferred Stock Rights and Preferences

**Conversion rights:** Each holder of the Preferred Shares has the right, at each holder’s sole discretion, to convert at any time and from time to time, all or any portion of the Preferred Shares into ordinary shares. The initial conversion ratio shall be on a one for one basis, subject to certain general anti-dilution adjustments.

The Preferred Shares will be automatically converted into ordinary shares upon (i) the closing of an initial public offering (IPO) based on the applicable then-effective conversion price or (ii) upon the date specified by written consent or agreement of the holder of the majority of the then outstanding Preferred Shares, voting together as a single class on an as-converted basis.

The initial conversion price and conversion ratio is the stated issuance price of the Preferred Shares and on a one-for-one basis, respectively. The above conversion prices are subject to adjustments in the event that YS Biopharma issues additional ordinary shares or additional deemed ordinary shares through options or convertible instruments for a consideration per share received by YS Biopharma less than the original respective conversion prices, as the case may be, in effect on the date of and immediately prior to such issue. In such event, the respective conversion price is reduced, concurrently with such issue, to a price as adjusted

according to an agreed-upon formula. The above conversion prices are also subject to adjustments on a proportional basis upon other dilution events.

**Voting rights:** Each holder of the Preferred Share is entitled to the number of votes equal to the number of ordinary shares into which such holder's preferred shares could be converted. The holders of the Preferred Shares shall vote together with ordinary shareholders, and not as a separate class or series, on all matters put before the shareholders.

**Liquidation preference:** Upon any liquidation, dissolution or winding up of YS Biopharma, either voluntary or involuntary (a "Liquidation Event"), or a Deemed Liquidation Event, the assets of YS Biopharma available for distribution shall be distributed in the following order: (i) each Series B Holder shall be entitled to receive, prior and in preference to any distribution of any of the assets of YS Biopharma to the Series A Holders and the Ordinary Holders, an amount per Series B Preferred Share held by such Series B Holder equal to the applicable Original Series B Issue Price plus a single interest at the rate of 8% of the applicable Original Series B Issue Price on an annum basis accumulated from the Original Series B Issue Date to the date such Series B Holder actually receives such repayment, plus all declared and accrued but unpaid dividends on each such Series B Preferred Share (collectively, the "Series B Liquidation Preference"); if the assets available to be distributed among the Series B Holders shall be insufficient to permit the payment to such holders, then the assets of YS Biopharma legally available for distribution shall be all distributed to the Series B Holders that would otherwise be respectively qualified therefor and entitled thereon such Series B Liquidation Preference on a pro rata basis; (ii) after full payment of the Series B Liquidation Preference, each Series A Holder shall be entitled to receive, prior and in preference to any distribution of any of the assets of YS Biopharma to the Ordinary Holders, an amount per Series A Preferred Share held by such Series A Holder equal to the applicable Original Series A Issue Price plus a single interest at the rate of 8% of the applicable Original Series A Issue Price on an annum basis accumulated from the applicable Original Series A Issue Date to the date such Series A Holder actually receives such repayment, plus all declared and accrued but unpaid dividends on each such Series A Preferred Share (collectively, the "Series A Liquidation Preference", together with the Series B Liquidation Preference, the "Liquidation Preference"); if the assets available to be distributed among the Series A Holders shall be insufficient to permit the payment to such holders, then the assets of YS Biopharma legally available for distribution shall be all distributed to the Series A Holders that would otherwise be respectively qualified therefor and entitled thereon such Series A Liquidation Preference on a pro rata basis; (iii) if there are assets of tYS Biopharma available for distribution after payment of the Liquidation Preference referred to in clauses (i) and (ii) above, the remaining assets of YS Biopharma available for distribution to the Shareholders shall be distributed ratably among the Ordinary Holders and Preferred Holders on an as-converted basis.

**Dividends:** No dividends, whether in cash, property, or shares of YS Biopharma or otherwise, shall be declared or paid on any other shares during any previous or current fiscal year of YS Biopharma unless and until a dividend in like or greater amount has first been declared or paid on each outstanding Preferred Share (on an as-if-converted basis). All accrued and unpaid dividends, if any shall, to the extent funds are legally available therefor and subject to YS Biopharma being able to pay its debts as they fall due and the value of YS Biopharma's assets exceeding its liabilities immediately after any payment of such dividends, be mandatorily paid upon the earlier to occur of (i) a Liquidation Event, (ii) an optional conversion of Preferred Shares, (iii) an automatic conversion of Preferred Shares and (iv) a redemption of Preferred Shares. No dividends were declared by YS Biopharma's Board of Directors to date.

**Redemption right:** The Preferred Shares are redeemable at the option of the holders for all or any less portion of the Preferred Shares as provided herein at any time following:

- The issuance date when YS Biopharma and its subsidiaries or any ordinary share holder has material default or breach of the Preferred Shares Agreements in terms of its representation, warranties, covenants and obligations and if such breach remains uncured for 30 days after holders of the Preferred Shares give a written request to YS Group; or
- the third (3rd) anniversary of the Original Series B Issue Date, if a Qualified IPO is not achieved; In respect of the Series A Preferred Shares held by Asia Ventures and F-Prime, provided however that during the eighteen (18) months period after January 28, 2021, Asia Ventures and F-Prime shall not exercise its redemption rights pursuant to that if YS Group is still actively preparing for a Qualified IPO; In respect of

the Series A Preferred Shares held by the Series A-1 Holders, at any time following the third (3rd) anniversary of January 28, 2021, if a Qualified IPO is not achieved; or

- When Mr. Zhang, the Chairman of YS Biopharma ceases to be employed or provide service to YS Biopharma.

Since the Series A, Series A-1 and Series B Convertible Redeemable Preferred Shares are redeemable at a determinable price on a determinable date, at the option of the holder, or upon occurrence of an event that depends solely on the passage of time, these Convertible Redeemable Preferred Shares are accounted for as mezzanine equity on the consolidated balance sheets.

The mezzanine equity is carried at the higher of (1) the carrying amount after the attribution of net income of YS Group or (2) the expected redemption value. YS Group accretes for the difference between the initial carrying value and the ultimate redemption price using the effective interest rate method (17% annual compound interest for Series A, 8% annual compound interest for Series A-1 and Series B) from the issuance dates to the earliest possible redemption date.

#### **NOTE 13 — STOCK-BASED COMPENSATION**

YS Group operates a share-based payment scheme (the “Scheme”) for the purpose of providing incentives and rewards to eligible participants who contribute to the success of YS Group’s operations. Eligible participants of the Scheme include YS Group’s directors, employees and consultants.

##### ***The 2010 Share Incentive Plan***

On June 21, 2010, YS Group adopted the 2010 Share Incentive Plan (the “Plan”) that has a contractual term of 10 years. The Plan provides for the granting of stock options and other stock-based awards to employees and directors. YS Group’s Board of Directors authorized and reserved for the issuance of up to 10,902,600 ordinary shares under the Plan for the period from 2010 to 2013. Starting from 1 January 2014, the maximum number of shares subject to awards that may be granted during any single calendar year is equal to 1.5% of total issued and outstanding shares as of the first business day of that calendar year.

The stock options granted to employees are accounted for as equity awards and measured at their grant date fair values. Options that vest based on service conditions generally will become vested over a three-year period in equal quarterly instalments of 0.08% each on the last day of every quarter that has elapsed until the options are 100% vested.

On January 1, 2015, an annual grant of 510,000 options, which vest based on performance conditions, were granted to various employees. The annual grant was applicable for calendar years 2015, 2016, 2017, 2018, 2019 and 2020, respectively. The options become vested in equal quarterly instalments based on performance targets established on January 1<sup>st</sup> of each calendar year from 2015 to 2020. There are no more grants after December 31, 2020 under the 2010 share incentive plan.

For options granted to YS Group’s senior executives, the grantee can exercise vested options after the commencement date of exercise and before the earlier of: 1) its contractual term (i.e. 10 years after each of its vesting date); or 2) 5 years after the grantee terminates their employment if the vested option has not been exercised.

For options granted to the remaining employees, the grantee can exercise vested options after the commencement date of exercise and before the earlier of: 1) its contractual term (i.e. 10 years after each of its vesting date); or 2) 12 months after the grantee terminates their employment if the vested option has not been exercised.

For those awards, evaluations are made as of each reporting period to assess the likelihood of performance criteria being met. Share-based payment expenses are then adjusted to reflect the revision of original estimates.

The exercise prices and exercise periods of the share options outstanding as at the end of each of the Relevant Periods are as follows:



	<u>Number of share options</u>	<u>Average exercise price per share option</u> (RMB)
At March 31, 2021	13,013,422	7.3289
Granted during the period	—	—
Forfeited during the period	—	—
Exercised during the period	—	—
Expired during the period	—	—
At March 31, 2022	<u>13,013,422</u>	<u>7.3289</u>
Granted during the period	—	—
Forfeited during the period	—	—
Exercised during the period	—	—
Expired during the period	—	—
At September 30, 2022	<u><u>13,013,422</u></u>	<u><u>7.3289</u></u>

The exercise prices and exercise periods of the share options outstanding as at the end of the reporting periods are as follows:

<u>Six Months Ended 30 September 2022 Number of options</u>	<u>Exercise price</u> (RMB)	<u>Exercise period</u>
6,133,005	3.4845	2021 – 2031
2,453,049	6.4631	2021 – 2026
<u>4,427,368</u>	13.1344	2021 – 2026
<u><u>13,013,422</u></u>		

#### ***Bonus incentive plan***

On January 1, 2015, YS Group launched a bonus incentive program effective for six years from launch date. The bonus incentive program is divided into two six-month periods each calendar year. The bonus incentive program specifies for each monthly tranche in the six-month period an independent performance condition for a stated period of service (i.e., one month). The bonus amount is determined on a monthly basis at month-end by the human resources department based on a reasonably objective performance criteria that serves as a basis for promotion and other compensation decisions. A fixed conversion price is then applied to the employee's month end bonus to determine the number of ordinary shares to be issued to the employee for each individual month. At the end of each respective six-month period, YS Group finalizes the vested ordinary shares to be issued to the employee.

Based on the above, the employee does not receive a number of ordinary shares with a fair value equal to a predominantly fixed dollar amount on the delivery date. Hence, the ordinary shares granted to employees are accounted for as equity awards. In addition, each monthly tranche should be accounted for as a separate award with its own service inception date, grant-date fair value, and respective requisite service period because the employee's ability to retain (vest in) the award pertaining to the current month is not dependent on service beyond the current month.

#### ***Restricted share units ("RSUs")***

On February 1, 2018, YS Group granted 2,770,000 RSUs to employees under the Plan. The weighted average grant-date fair value of restricted shares units granted was \$1.81, which was derived from the fair value of the underlying ordinary shares. 1,620,000 out of the 2,770,000 restricted share units were subject to service

conditions vesting in six equal semi-annual instalments over three years or eight equal semi-annual instalments over four years, respectively.

As of September 30, 2022, all the granted options are vested, and there were no unrecognized share-based payment expenses related to unvested restricted shares. The remaining 1,150,000 RSUs will be vested only upon the successful closing of an IPO. Given that this constitutes a performance condition that is not considered probable until the IPO completion date, YS Group will not recognize any compensation expense until an IPO occurs. Upon the IPO completion date, YS Group will immediately recognize expenses associated with these RSUs.

On July 25, 2018, YS Group granted 1,080,000 units of RSUs to three independent directors. Starting from the effective date of August 1, 2018, 120,000 RSUs will be awarded to each of the three directors annually, which shall be vested in equal portion of 30,000 units per three months' Director services rendered by each director. For each of the new directors, 20,000 units will be vested for the two-month period starting from August 1, 2018, and the remaining are vested on quarterly basis starting from October 1, 2018 to July 31, 2021. The grant-date fair value of the restricted share units was \$1.84, which was derived from the fair value of the underlying ordinary shares. As of September 30, 2022, all the granted options are vested and there were no unrecognized share-based payment expenses related to unvested restricted shares.

#### ***The 2020 Share Incentive Plan***

On December 31, 2020, YS Group's board of directors adopted the 2020 Share Incentive Plan for the purpose of granting share-based compensation awards to employees, directors and consultants to incentivize their performance and align their interests with YS Group. Pursuant to such plan, YS Group is entitled to grant awards to directors, employees and consultants of YS Group with rights to subscribe for up to 35,000,000 underlying ordinary shares of YS Biopharma. As of the date of this report, (1) 8,373,671 shares as RSU incentive shares were fully vested and issued to the respective directors and employees of YS Group, and (2) 26,626,329 shares are reserved but not issued, among which, options to subscribe for 13,886,187 ordinary shares of YS Biopharma are granted to certain senior management and employees of YS Group but not exercised.

Stock-based compensation expense included in YS Group's consolidated statements of operations and comprehensive loss is as follows:

	<b>Six Months Ended September 30,</b>		
	<b>2021</b>	<b>2022</b>	<b>2022</b>
	<b>(Unaudited)</b>	<b>(Unaudited)</b>	<b>(Unaudited)</b>
Research and development expenses	492,764	(1,015,055)	\$(142,970)
General and administrative expenses	2,635,978	929,739	130,953
<b>Total stock-based compensation</b>	<b>3,128,742</b>	<b>(85,316)</b>	<b>\$ (12,017)</b>

On August 15, 2022, unanimous written resolution of the board of director of YS Group accepted the notice from a former employee, for the surrender of 575,000 of issued shares with US\$0.000005 each in YS Group registered in his name.

#### **NOTE 14—RELATED PARTY TRANSACTIONS AND BALANCES**

The following companies are related parties that had balances or transactions with YS Group as of and during the six months ended September 30, 2022 and 2021:

<u>Name of related parties</u>	<u>Relationship with YS Group</u>
Yisheng Biopharma Co., Ltd	An entity controlled by Yi Zhang
Yisheng Biopharma Holdings Ltd.	An entity controlled by Yi Zhang
Beijing Yisheng Xingye Technology Co., Ltd.	An entity controlled by Yi Zhang

**Transactions with related parties**

YS Group had the following transactions with related parties, all of which are interest-free during the six months ended September 30, 2022 and 2021:

	Six Months Ended September 30,		
	2021	2022	2022
	(RMB)	(RMB)	(\$)
	(Unaudited)	(Unaudited)	(Unaudited)
<b>Amounts due from related party:</b>			
<b>Yisheng Biopharma Holdings Limited (Hong Kong)</b>			
Receivable collected on behalf of YS Group	2,966,777	—	\$—
Repayment to YS Group	33,055,610	—	\$—

In fiscal 2021, YS Group lent RMB30,088,833 to Yisheng Biopharma Holdings Limited (Hong Kong) for its operating needs. In fiscal 2022, YS Group lent another RMB2,966,777 to Yisheng Biopharma Holdings Limited (Hong Kong), and Yisheng Biopharma Holdings Limited (Hong Kong) repaid RMB33,055,610 in full to YS Group. As of September 30, 2022, the balance of amount due from Yisheng Biopharma Holdings Limited (Hong Kong) is RMB nil.

From time to time, and prior to the business reorganization that completed in February 2021, YS Group borrowed or lent money to or from the following related parties that were under common control of Mr. Zhang for working capital purposes:

**Beijing Yisheng Xingye Technology Co., Ltd. (PRC) (“Beijing Yisheng Xingye”)**

In the six months ended September 30, 2021, Beijing Yisheng Xingye lent RMB46,970 to YS Group, and YS Group repaid it in full. As of September 30, 2022, the balance of amount due to Beijing Yisheng Xingye was RMB nil.

**Yisheng Biopharma Co., Ltd. (“Yisheng Biopharma”)**

In the six months ended September 30, 2021, Yisheng Biopharma lent RMB64,880 to YS Group, and YS Group repaid it in full during the same year. As of September 30, 2022, the amount due to Yisheng Biopharma was RMB nil.

**NOTE 15—INCOME TAX**

**Cayman Islands.** Under the current laws of the Cayman Islands, YS Group is not subject to tax on income or capital gains. In addition, upon payments of dividends by YS Group to its shareholders, no Cayman Islands withholding tax is imposed.

**Hong Kong.** Under the Hong Kong tax laws, Yisheng Hong Kong, as a holding company, is exempted from profit tax on its foreign-sourced income and there are no withholding taxes in Hong Kong on remittance of dividends.

**Singapore.** Yisheng Singapore, a subsidiary incorporated in Singapore, files separate income tax returns in Singapore at the statutory income tax rate of 17%.

**China.** Under the Enterprise Income Tax (“EIT”) Law of the PRC, domestic enterprises and Foreign Investment Enterprises (the “FIE”) are usually subject to a unified 25% EIT rate while preferential tax rates, tax holidays, and even tax exemption may be granted on case-by-case basis. The PRC tax authorities grant preferential tax treatment to High and New Technology Enterprises (“HNTEs”). Under this preferential tax treatment, HNTEs are entitled to an income tax rate of 15%, subject to a requirement that they re-apply for HNTE status every three years. Since Liaoning Yisheng was approved as an HNTE in December 2021, Liaoning Yisheng is entitled to a reduced income tax rate of 15% and is able to enjoy the reduced income tax rate in the next three years.

**United States.** US Yisheng, a subsidiary incorporated in Maryland, United States is subject to statutory federal corporate income tax at a rate of 21% and state income tax at a rate of 8.25%.

The provision for income tax consisted of the following:

	Six Months Ended September 30,		
	2021	2022	2022
	(RMB)	(RMB)	(\$)
	(Unaudited)	(Unaudited)	(Unaudited)
Current income tax	—	—	\$ —
Deferred tax	5,689,586	565,625	79,668
<b>Income tax</b>	<b>5,689,586</b>	<b>565,625</b>	<b>\$79,668</b>

The following table reconciles the statutory rate to YS Group's effective tax rate:

	Six Months Ended September 30,	
	2021	2022
	(Unaudited)	(Unaudited)
PRC statutory income tax rate	25.00%	25.00%
Effect of different tax rates in different jurisdictions	(26.82)%	(182.62)%
Effect of PRC preferential tax rate	11.98%	(100.49)%
Effect of research and development expenses deduction and Others	30.97%	80.56%
Temporary differences*	13.42%	5.03%
Change in valuation allowance	(41.02)%	177.88%
<b>Effective tax rate</b>	<b>13.53%</b>	<b>5.36%</b>

\* Temporary differences primarily relate to impairment of inventories, property, plant and equipment and government grants.

Net deferred tax assets as of September, 2022 and March 31, 2022, consist of the following key components:

	March 31, 2022	September 30, 2022	September 30, 2022
	(RMB)	(RMB)	(\$)
		(Unaudited)	(Unaudited)
<b>Deferred tax assets:</b>			
Write-down of inventories to net realizable value	825,454	166,410	\$ 23,439
Impairment of property, plant and building	2,031,460	1,900,433	267,674
Deferred government grants	4,852,383	4,680,205	659,202
Losses available for offsetting against future taxable profits	58,257,270	47,805,830	6,733,405
Less: valuation allowance	(58,257,270)	(47,805,830)	(6,733,405)
<b>Total deferred tax assets, net</b>	<b>7,709,297</b>	<b>6,747,048</b>	<b>950,315</b>
<b>Deferred tax liabilities:</b>			
Fair value adjustments arising from historical acquisition of subsidiaries	(4,670,213)	(4,273,589)	(601,931)
<b>Total deferred tax liabilities</b>	<b>(4,670,213)</b>	<b>(4,273,589)</b>	<b>(601,931)</b>
<b>Net deferred tax asset</b>	<b>3,039,084</b>	<b>2,473,459</b>	<b>\$ 348,384</b>

In assessing the realizability of the net deferred tax assets, YS Group considers all relevant positive and negative evidence in determining whether it is more likely than not that some portion or all of the deferred income tax assets will not be realized. The realization of the gross deferred tax assets is dependent on several factors,

including the generation of sufficient taxable income in the future. Based upon an assessment of the level of historical taxable income and projections for future taxable income over the periods in which the deferred tax assets are deductible or can be utilized, YS Group provided valuation allowance of RMB47.8 million as of September 30, 2022 and RMB58.3 million as of March 31, 2022, respectively. The amount of the deferred tax asset is considered unrealizable because it is more likely than not that YS Group will not generate sufficient future taxable income to utilize this portion of the net operating loss.

#### *Uncertain tax positions*

There were no uncertain tax positions as of September 30, 2022 and 2021 and management does not anticipate any potential future adjustments which would result in a material change to its tax positions.

#### **NOTE 16 — DEFERRED GOVERNMENT GRANTS**

Deferred government grants represent funds received from the PRC government for research and development, investment in building or improvement in YS Group's production facilities. These specific subsidies are recorded as deferred government grants upon receipt and are recognized as government grants recognized in income when the conditions are met. Other subsidies are recognized as other income upon receipt as further performance by YS Group is not required. YS Group received government grants that were deferred in the amount of RMB 1.2 million and RMB1.5 million in the six months of 2022 and 2021, respectively. In addition, YS Group received RMB 13.2 million and RMB18.5 million other subsidies that the government has not set any conditions and are not tied to future trends or performance of YS Group and were recognized in other income in 2022 and 2021, respectively.

Deferred government grants included the following:

	<u>March 31, 2022</u>	<u>September 30, 2022</u>	<u>September 30, 2022</u>
	<u>(RMB)</u>	<u>(RMB)</u>	<u>(\$)</u>
		(Unaudited)	(Unaudited)
<b>Government grants for property, plant and equipment</b>			
Balance at beginning of the year	21,847,340	22,030,690	\$ 3,103,001
Addition	1,552,000	1,200,000	169,019
Recognized as income	(1,368,650)	(727,839)	(102,515)
<b>Subtotal</b>	<b><u>22,030,690</u></b>	<b><u>22,502,851</u></b>	<b><u>\$ 3,169,505</u></b>
<b>Government grants for research and development</b>			
Balance at beginning of the year	11,158,551	10,318,528	\$ 1,453,355
Addition	—	—	—
Recognized as income	(840,023)	(8,498,712)	(1,197,036)
<b>Subtotal</b>	<b><u>10,318,528</u></b>	<b><u>1,819,816</u></b>	<b><u>\$ 256,319</u></b>
<b>Total deferred government grants</b>	<b><u>32,349,218</u></b>	<b><u>24,322,667</u></b>	<b><u>\$ 3,425,824</u></b>
<b>Less: current portion</b>	<b><u>(2,295,701)</u></b>	<b><u>(3,495,701)</u></b>	<b><u>(492,366)</u></b>
<b>Non-current portion</b>	<b><u>30,053,517</u></b>	<b><u>20,826,966</u></b>	<b><u>\$ 2,933,458</u></b>

#### *Government grants for property, plant and equipment*

YS Group has seven deferred government grants related to property, plant and equipment, and fulfilled the conditions attached to all the grants. RMB 0.6 million was amortized from deferred government grant into government grant recognized in income in the six months ended September 30, 2022, and RMB1.4 million for the six months ended September 30, 2021. RMB2.7 million will be amortized in next 12 months end September 30, 2023, which was included in the current deferred government grant and RMB 19.8 million will be amortized after September 2023 which was included in the non-current portion of deferred government grants.

#### *Government grants for research and development*

YS Group has two deferred government grants related to various research and development projects, and fulfilled the conditions attached to one grant in 2010. RMB8.5 million was amortized from deferred

government grant into government grant recognized in income in six months ended September 30, 2022, and RMB0.8 million for the six months ended September 30, 2021. RMB 0.8 million will be amortized in next 12 months ended September 30, 2023 which was included in the current deferred government grant and RMB 1.0 million will be amortized after September 2023 which was included in the non-current portion of deferred government grants. The remaining grant's condition is expected to be fulfilled after 2022 and RMB 1.0 million is recorded in the non-current portion of deferred government grants.

#### NOTE 17—COMMITMENTS AND CONTINGENCIES

As of September 30, 2022, YS Group has the following commitments to purchase raw materials or services:

	As of September 30,	
	2022	2022
	(RMB)	(\$)
Construction of vaccine production facilities		
Office of Life Sciences	1,580,000	\$ 222,541
Research and development	6,001,375	845,288
Purchase raw materials	20,236,200	2,850,249
<b>Total</b>	<b>27,817,575</b>	<b>\$3,918,078</b>

In 2018, Liaoning Yisheng filed a sales contract dispute with Hebei Defense Biological Products Supply Center. The Supreme People's Court of Liaoning supported Liaoning Yisheng's claim that the defendant Hebei Weifang should pay RMB2,465,807 for Liaoning Yisheng vaccine within 20 days after the judgment came into effect. As of the date of this report, YS Group received RMB1,636,755 compensation from Hebei Defense Biological Products Supply Center and the balance of RMB829,052 compensation may be received in fiscal 2024.

In 2019, Liaoning Yisheng filed a sales contract dispute with Chaoyang Center for Disease Control and Prevention. The Supreme People's Court of Liaoning supported Liaoning Yisheng's claim that the defendant Chaoyang Center for Disease Control and Prevention should pay RMB416,900 for Liaoning Yisheng vaccine. To the date, YS Group received RMB300,000 from Chaoyang Center for Disease Control and Prevention, and the balance of RMB116,900 may be received in fiscal 2023.

YS Group was also involved in certain other labor disputes as of September 30, 2022. As the proceedings are in the early stages, there is considerable uncertainty regarding the timing or ultimate resolution of such matters, and therefore, an estimate for the reasonably possible loss or a range of reasonably possible losses cannot be made.

#### NOTE 18—SEGMENT INFORMATION

Based on management's assessment, YS Group has one operating segment, which is the development, production, marketing and sale of biopharmaceutical products. No operating segments were aggregated to form the reportable operating segment.

YS Group's non-current assets are located in the PRC and other countries, such as Singapore and United States. The location of these non-current assets can be aggregated to form the reportable geographical segment.

	March 31, 2022	September 30, 2022	September 30, 2022
	(RMB)	(RMB)	(\$)
		(Unaudited)	(Unaudited)
PRC	604,094,049	613,613,563	\$86,426,880
Other countries/regions	26,777,039	25,068,223	\$ 3,530,835

The non-current asset information above is based on the location of the assets and excludes financial instruments and deferred tax assets.

**NOTE 19—SUBSEQUENT EVENTS**

YS Group performed an evaluation of events and transactions for potential recognition or disclosure through the date of this report. YS Group is not aware of any material subsequent events other than those disclosed below and elsewhere in the notes to the CFS.

On November 8, 2022, YS Group entered into a sale-leaseback agreement of RMB26 million for 3 years, from November 8, 2022 to November 7, 2025, with a 5% interest rate.

YS Group repaid approximately RMB36 million to China Guangfa Bank Co., Ltd. Shenyang Branch, and approximately RMB28 million to Shanghai Pudong Development Bank Co., Ltd. Shenyang Branch from October 1, 2022 to December 16, 2022.

And YS Group drew another approximately RMB13 million with interest at 5.655% from China Guangfa Bank Co., Ltd. Shenyang Branch, approximately RMB30 million with interest at 5.3% from Shanghai Pudong Development Bank Co., Ltd. Shenyang Branch, and approximately RMB19 million with interest at 4.0% from China Construction Bank — Shenyang Branch.

**NOTE 20—PARENT COMPANY ONLY CONDENSED FINANCIAL INFORMATION (UNAUDITED)**

Pursuant to the requirements of Rule 12-04(a), 5-04(c) and 4-08(e)(3) of Regulation S-X, the condensed financial information of the parent company shall be filed when the restricted net assets of consolidated subsidiaries exceed 25% of consolidated net assets as of the end of the most recently completed fiscal year. YS Group performed a test on the restricted net assets of consolidated subsidiaries in accordance with such requirement and concluded that it was applicable to YS Group as the restricted net assets of YS Group's PRC subsidiaries exceeded 25% of the consolidated net assets of YS Group. Therefore, the condensed financial statements of the parent company are included herein.

## PARENT COMPANY BALANCE SHEETS

	March 31, 2022	September 30, 2022	September 30, 2022
	(RMB)	(RMB)	(\$)
	(Unaudited)	(Unaudited)	(Unaudited)
<b>ASSETS</b>			
<b>Current Assets</b>			
Cash	252,611,535	3,943,175	\$ 555,392
Amounts due from related parties	519,236,876	848,379,306	119,493,409
<b>Total current assets</b>	<b>771,848,411</b>	<b>852,322,481</b>	<b>120,048,801</b>
<b>Non-current assets</b>			
Long-term investments, net	146,641,652	164,003,403	23,099,722
<b>Total non-current assets</b>	<b>146,641,652</b>	<b>164,003,403</b>	<b>23,099,722</b>
<b>Total Assets</b>	<b>918,490,063</b>	<b>1,016,325,884</b>	<b>\$ 143,148,523</b>
<b>LIABILITIES AND EQUITY</b>			
<b>Current Liabilities</b>			
Accrued expenses and other liabilities	244,082,463	354,920,428	\$ 49,990,201
Amounts due to related parties	3,155,395	3,528,981	497,054
<b>Total current liabilities</b>	<b>247,237,858</b>	<b>358,449,409</b>	<b>50,487,255</b>
<b>Total Liabilities</b>	<b>247,237,858</b>	<b>358,449,409</b>	<b>50,487,255</b>
<b>Mezzanine equity</b>			
Series A and A-1 redeemable convertible preferred shares (par value US\$0.000005 per share, 50,000,000 shares authorized; 21,548,589 shares issued and outstanding)	458,074,468	551,004,725	77,608,485
Series B redeemable convertible preferred shares (par value US\$0.000005 per share, 100,000,000 shares authorized; 65,414,858 shares issued and outstanding)	912,146,924	1,057,557,002	148,955,886
<b>Total mezzanine equity</b>	<b>1,370,221,392</b>	<b>1,608,561,727</b>	<b>226,564,371</b>
<b>Shareholders' deficit:</b>			
Ordinary shares, par value US\$0.000005 per share, 9,950,000,000 shares authorized, 247,311,533 shares issued and outstanding as of March 31, 2022 and 246,736,533 shares issued and outstanding as of September 30, 2022	7,978	7,978	1,124
Additional paid-in capital	808,502,018	808,648,509	113,897,365
Accumulated deficit	(1,590,567,163)	(1,673,775,766)	(235,749,706)
Accumulated other comprehensive income (loss)	83,087,980	(85,565,973)	(12,051,886)
<b>Total shareholders' deficit</b>	<b>(698,969,187)</b>	<b>(950,685,252)</b>	<b>(133,903,103)</b>
<b>Total liabilities, mezzanine equity and shareholders' deficit</b>	<b>918,490,063</b>	<b>1,016,325,884</b>	<b>\$ 143,148,523</b>



## PARENT COMPANY STATEMENTS OF OPERATIONS AND COMPREHENSIVE LOSS

	For the Six Months Ended September 30,		
	2021	2022	2022
	(RMB)	(RMB)	(\$)
	(Unaudited)	(Unaudited)	(Unaudited)
<b>Equity loss of subsidiaries</b>	<b>(27,562,274)</b>	<b>(5,703,582)</b>	<b>\$ (803,346)</b>
<b>Operating expenses:</b>			
Selling			
General and administrative	17,037,618	6,356,204	895,265
Research and development	492,764	(934,367)	(131,605)
<b>Total operating expenses</b>	<b>17,530,382</b>	<b>5,421,837</b>	<b>763,660</b>
<b>Loss from operations</b>	<b>(45,092,656)</b>	<b>(11,125,419)</b>	<b>(1,567,006)</b>
<b>Other income:</b>			
Financial income, net	1,324	54	8
<b>Total other income, net</b>	<b>1,324</b>	<b>54</b>	<b>8</b>
<b>Net loss</b>	<b>(45,091,332)</b>	<b>(11,125,365)</b>	<b>(1,566,998)</b>
Accretion to redemption value of convertible redeemable preferred shares	(65,013,751)	(72,083,238)	(10,152,855)
<b>Net loss attributable to YS Biopharma</b>	<b>(110,105,083)</b>	<b>(83,208,603)</b>	<b>(11,719,853)</b>
<b>Net loss</b>	<b>(45,091,332)</b>	<b>(11,125,365)</b>	<b>(1,566,998)</b>
Feign currency translation gain	11,321,167	(168,653,952)	(23,754,747)
<b>Total comprehensive loss</b>	<b>(33,770,165)</b>	<b>(179,779,317)</b>	<b>\$ (25,321,745)</b>
<b>Loss per share*:</b>			
– Basic and Diluted	(0.18)	(0.04)	\$ (0.01)
<b>Weighted average number of ordinary shares outstanding*:</b>			
– Basic and Diluted	247,311,533	247,311,533	247,311,533

\* Gives retroactive effect to reflect the reorganization in February 2021.

## PARENT COMPANY STATEMENTS OF CASH FLOWS

	Six Months Ended September 30,		
	2021	2022	2022
	(RMB)	(RMB)	(\$)
	(Unaudited)	(Unaudited)	(Unaudited)
Net loss	(45,091,332)	(11,125,365)	\$ (1,566,998)
Equity loss of subsidiaries	27,562,274	5,703,582	803,346
Share-based compensation	3,128,741	(85,316)	(12,017)
Changes in operating assets and liabilities:			
Amounts due from related parties	(298,261,642)	(328,910,623)	(46,326,745)
Amounts due to related parties	(42,697)	373,586	52,619
Accrued expenses and other liabilities	(7,357,523)	55,467,639	7,812,564
<b>Net cash used in operating activities</b>	<b>(320,062,179)</b>	<b>(278,576,497)</b>	<b>(39,237,231)</b>
Effect of exchange rate on cash	(4,446,303)	29,908,137	4,212,531
<b>Net decrease in cash</b>	<b>(324,508,482)</b>	<b>(248,668,360)</b>	<b>(35,024,700)</b>
<b>Cash at the beginning of the period</b>	<b>330,296,949</b>	<b>252,611,535</b>	<b>35,580,092</b>
<b>Cash at the end of the period</b>	<b>5,788,467</b>	<b>3,943,175</b>	<b>\$ 555,392</b>
<b>Non-cash transactions:</b>			
Accretion to redemption value of convertible redeemable preferred shares	65,013,751	72,083,238	\$ 10,152,855

**BUSINESS COMBINATION AGREEMENT**

**by and among**

**YishengBio Co., Ltd.,**

**Oceanview Bioscience Acquisition Co., Ltd.,**

**Hudson Biomedical Group Co., Ltd.,**

**and**

**Summit Healthcare Acquisition Corp.**

**dated as of September 29, 2022**

---

## TABLE OF CONTENTS

	Page
<b>ARTICLE I CERTAIN DEFINITIONS</b>	<b>A-3</b>
Section 1.1    Definitions	A-3
Section 1.2    Construction	A-15
<b>ARTICLE II TRANSACTIONS; CLOSING</b>	<b>A-16</b>
Section 2.1    Pre-Closing Actions	A-16
Section 2.2    The Mergers	A-17
Section 2.3    Closing	A-20
Section 2.4    Cancellation of SPAC Equity Securities and Disbursement of Merger Consideration	A-21
Section 2.5    Further Assurances	A-22
Section 2.6    Dissenter's Rights	A-22
Section 2.7    Withholding	A-23
<b>ARTICLE III REPRESENTATIONS AND WARRANTIES OF THE COMPANY</b>	<b>A-23</b>
Section 3.1    Organization, Good Standing and Qualification	A-23
Section 3.2    Subsidiaries	A-24
Section 3.3    Capitalization of the Company	A-24
Section 3.4    Capitalization of Subsidiaries	A-25
Section 3.5    Authorization	A-25
Section 3.6    Consents; No Conflicts	A-26
Section 3.7    Compliance with Laws; Consents; Permits	A-26
Section 3.8    Tax Matters	A-28
Section 3.9    Financial Statements	A-29
Section 3.10   Absence of Changes	A-29
Section 3.11   Actions	A-29
Section 3.12   Liabilities	A-30
Section 3.13   Material Contracts and Commitments	A-30
Section 3.14   Title; Properties	A-30
Section 3.15   Intellectual Property Rights	A-31
Section 3.16   Labor and Employee Matters	A-32
Section 3.17   Brokers	A-34
Section 3.18   Environmental Matters	A-34
Section 3.19   Insurance	A-34
Section 3.20   Company Related Parties	A-34
Section 3.21   Proxy/Registration Statement	A-34
Section 3.22   Foreign Private Issuer	A-34
Section 3.23   No Additional Representation or Warranties	A-34
<b>ARTICLE IV REPRESENTATIONS AND WARRANTIES OF SPAC</b>	<b>A-34</b>
Section 4.1    Organization, Good Standing, Corporate Power and Qualification	A-35
Section 4.2    Capitalization and Voting Rights	A-35
Section 4.3    Corporate Structure; Subsidiaries	A-36
Section 4.4    Authorization	A-36

	<u>Page</u>
<u>Section 4.5</u> <u>Consents; No Conflicts</u>	<u>A-37</u>
<u>Section 4.6</u> <u>Tax Matters.</u>	<u>A-37</u>
<u>Section 4.7</u> <u>Financial Statements.</u>	<u>A-38</u>
<u>Section 4.8</u> <u>Absence of Changes</u>	<u>A-39</u>
<u>Section 4.9</u> <u>Actions</u>	<u>A-39</u>
<u>Section 4.10</u> <u>Brokers</u>	<u>A-39</u>
<u>Section 4.11</u> <u>Proxy/Registration Statement</u>	<u>A-39</u>
<u>Section 4.12</u> <u>SEC Filings</u>	<u>A-39</u>
<u>Section 4.13</u> <u>Trust Account</u>	<u>A-39</u>
<u>Section 4.14</u> <u>Investment Company Act; JOBS Act</u>	<u>A-40</u>
<u>Section 4.15</u> <u>Business Activities.</u>	<u>A-40</u>
<u>Section 4.16</u> <u>Nasdaq Quotation</u>	<u>A-41</u>
<u>Section 4.17</u> <u>Forward Purchase Subscriptions.</u>	<u>A-41</u>
<u>Section 4.18</u> <u>SPAC Related Parties</u>	<u>A-41</u>
<u>Section 4.19</u> <u>No Outside Reliance</u>	<u>A-41</u>
<b>ARTICLE V REPRESENTATIONS AND WARRANTIES OF THE MERGER SUBS</b>	<u>A-42</u>
<u>Section 5.1</u> <u>Organization, Good Standing, Corporate Power and Qualification</u>	<u>A-42</u>
<u>Section 5.2</u> <u>Capitalization and Voting Rights.</u>	<u>A-42</u>
<u>Section 5.3</u> <u>Corporate Structure; Subsidiaries</u>	<u>A-42</u>
<u>Section 5.4</u> <u>Authorization</u>	<u>A-43</u>
<u>Section 5.5</u> <u>Consents; No Conflicts</u>	<u>A-43</u>
<u>Section 5.6</u> <u>Absence of Changes</u>	<u>A-43</u>
<u>Section 5.7</u> <u>Actions</u>	<u>A-43</u>
<u>Section 5.8</u> <u>Brokers</u>	<u>A-43</u>
<u>Section 5.9</u> <u>Proxy/Registration Statement</u>	<u>A-43</u>
<u>Section 5.10</u> <u>Business Activities</u>	<u>A-44</u>
<u>Section 5.11</u> <u>Tax Classification</u>	<u>A-44</u>
<u>Section 5.12</u> <u>No Outside Reliance</u>	<u>A-44</u>
<b>ARTICLE VI COVENANTS OF THE COMPANY AND CERTAIN OTHER PARTIES</b>	<u>A-44</u>
<u>Section 6.1</u> <u>Conduct of Business</u>	<u>A-44</u>
<u>Section 6.2</u> <u>Access to Information</u>	<u>A-46</u>
<u>Section 6.3</u> <u>Acquisition Proposals and Alternative Transactions</u>	<u>A-47</u>
<u>Section 6.4</u> <u>D&amp;O Indemnification and Insurance.</u>	<u>A-47</u>
<u>Section 6.5</u> <u>Notice of Developments</u>	<u>A-48</u>
<u>Section 6.6</u> <u>Financials.</u>	<u>A-49</u>
<u>Section 6.7</u> <u>No Trading</u>	<u>A-49</u>
<u>Section 6.8</u> <u>Nasdaq Listing</u>	<u>A-49</u>
<u>Section 6.9</u> <u>Company Incentive Plan</u>	<u>A-49</u>
<u>Section 6.10</u> <u>Post-Closing Directors and Officers of the Company.</u>	<u>A-49</u>
<u>Section 6.11</u> <u>Public Filings</u>	<u>A-50</u>
<u>Section 6.12</u> <u>Change of Name.</u>	<u>A-50</u>

	<u>Page</u>
<b><u>ARTICLE VII COVENANTS OF SPAC AND THE MERGER SUBS</u></b>	<b><u>A-50</u></b>
<u>Section 7.1 Nasdaq Listing</u>	<u>A-50</u>
<u>Section 7.2 Conduct of Business</u>	<u>A-50</u>
<u>Section 7.3 Acquisition Proposals and Alternative Transactions</u>	<u>A-51</u>
<u>Section 7.4 Public Filings of SPAC</u>	<u>A-51</u>
<u>Section 7.5 Access to Information</u>	<u>A-51</u>
<b><u>ARTICLE VIII JOINT COVENANTS</u></b>	<b><u>A-52</u></b>
<u>Section 8.1 Regulatory Approvals; Other Filings</u>	<u>A-52</u>
<u>Section 8.2 Preparation of Proxy/Registration Statement; SPAC Shareholders' Meeting and Approvals</u>	<u>A-53</u>
<u>Section 8.3 Support of Transaction</u>	<u>A-55</u>
<u>Section 8.4 Tax Matters</u>	<u>A-55</u>
<u>Section 8.5 Shareholder Litigation</u>	<u>A-56</u>
<u>Section 8.6 Forward Purchase Subscriptions</u>	<u>A-56</u>
<u>Section 8.7 Use of Remaining Trust Fund Proceeds</u>	<u>A-57</u>
<b><u>ARTICLE IX CONDITIONS TO OBLIGATIONS 62</u></b>	<b><u>A-57</u></b>
<u>Section 9.1 Conditions to Obligations of SPAC, the Merger Subs and the Company</u>	<u>A-57</u>
<u>Section 9.2 Conditions to Obligations of SPAC at Closing</u>	<u>A-58</u>
<u>Section 9.3 Conditions to Obligations of the Company and the Merger Subs at Closing</u>	<u>A-58</u>
<u>Section 9.4 Frustration of Conditions</u>	<u>A-59</u>
<b><u>ARTICLE X TERMINATION/EFFECTIVENESS</u></b>	<b><u>A-59</u></b>
<u>Section 10.1 Termination</u>	<u>A-59</u>
<u>Section 10.2 Effect of Termination</u>	<u>A-60</u>
<b><u>ARTICLE XI MISCELLANEOUS</u></b>	<b><u>A-60</u></b>
<u>Section 11.1 Trust Account Waiver</u>	<u>A-60</u>
<u>Section 11.2 Waiver</u>	<u>A-61</u>
<u>Section 11.3 Notices</u>	<u>A-61</u>
<u>Section 11.4 Assignment</u>	<u>A-61</u>
<u>Section 11.5 Rights of Third Parties</u>	<u>A-62</u>
<u>Section 11.6 Expenses</u>	<u>A-62</u>
<u>Section 11.7 Governing Law</u>	<u>A-62</u>
<u>Section 11.8 Consent to Jurisdiction; Waiver of Trial by Jury</u>	<u>A-62</u>
<u>Section 11.9 Headings; Counterparts</u>	<u>A-63</u>
<u>Section 11.10 Disclosure Letters</u>	<u>A-63</u>
<u>Section 11.11 Entire Agreement</u>	<u>A-63</u>
<u>Section 11.12 Amendments</u>	<u>A-63</u>
<u>Section 11.13 Publicity</u>	<u>A-64</u>
<u>Section 11.14 Confidentiality</u>	<u>A-64</u>
<u>Section 11.15 Severability</u>	<u>A-64</u>
<u>Section 11.16 Enforcement</u>	<u>A-64</u>
<u>Section 11.17 Non-Recourse</u>	<u>A-64</u>
<u>Section 11.18 Non-Survival of Representations, Warranties and Covenants</u>	<u>A-64</u>
<u>Section 11.19 Conflicts and Privilege</u>	<u>A-65</u>

**Exhibits**

**EXHIBIT A FORM OF SHAREHOLDER SUPPORT AGREEMENT**

**EXHIBIT B FORM OF WARRANT ASSIGNMENT AGREEMENT**

**EXHIBIT C-1 FORM OF PLAN OF FIRST MERGER**

**EXHIBIT C-2 FORM OF PLAN OF SECOND MERGER**

**EXHIBIT D-1 FORM OF AMENDED ARTICLES OF THE SURVIVING ENTITY**

**EXHIBIT D-2 FORM OF AMENDED ARTICLES OF THE SURVIVING COMPANY**

**EXHIBIT E FORM OF AMENDED COMPANY CHARTER**

**EXHIBIT F FORM OF AMENDED COMPANY INCENTIVE PLAN**

**Schedules**

**SCHEDULE I SPAC DISCLOSURE LETTER**

**SCHEDULE II COMPANY DISCLOSURE LETTER**

**SCHEDULE III THE COMPANY OFFICERS**

## INDEX OF DEFINED TERMS

Action	Section 1.1
Affiliate	Section 1.1
Agreement	Preamble
Amended Articles of the Surviving Company	Section 2.2(e)
Amended Articles of the Surviving Entity	Section 2.2(e)
Amended Company Charter	Section 2.1(b)
Amended Company Incentive Plan	Section 6.9
Anti-Corruption Laws	Section 3.7(d)
Anti-Money Laundering Laws	Section 1.1
Audited Financial Statements	Section 3.9(a)
Authorization Notice	Section 2.6(c)(i)
Available Closing Cash Amount	Section 1.1
Benefit Plan	Section 1.1
Blue Sky	Section 8.2(a)(i)
BofA Waiver Letter	Section 1.1
Business Combination	Recitals, Section 1.1
Business Day	Section 1.1
Cayman Act	Recitals
Closing	Section 2.3(a)
Closing Date	Section 2.3(a)
Code	Section 1.1
Commercialization	Section 1.1
Commercialize	Section 1.1
Commercialized	Section 1.1
Commercializing	Section 1.1
Company	Preamble
Company Acquisition Proposal	Section 1.1
Company Board	Recitals
Company Capital Restructuring	Recitals
Company Charter	Section 1.1
Company Contract	Section 1.1
Company Directors	Section 2.2(g)
Company Disclosure Letter	Article III
Company IP	Section 1.1
Company Lease	Section 3.14(b)
Company Lender's Approval	Section 3.5(b)
Company Material Adverse Effect	Section 1.1
Company Material Lease	Section 3.14(b)
Company Options	Section 1.1
Company Ordinary Shares	Section 1.1
Company Preferred Shares	Section 1.1
Company Products	Section 1.1



Company Series A Preferred Shares	Section 1.1
Company Series B Preferred Shares	Section 1.1
Company Shareholder	Section 1.1
Company Shareholders' Approval	Section 3.5(b)
Company Shareholders' Meeting	Section 3.5(b)
Company Shares	Section 1.1
Company Systems	Section 3.15(e)
Company Transaction Expenses	Section 1.1
Company Warrant	Section 2.2(h)(iii)
Competing SPAC	Section 1.1
Confidential Information	Section 11.14
Continuing Option	Section 2.1(a)(iii)
Contract	Section 1.1
Control	Section 1.1
Controlled	Section 1.1
Controlling	Section 1.1
Conversion	Section 2.1(a)(i)
Cooley	Section 11.19(a)
COVID-19	Section 1.1
COVID-19 Measures	Section 1.1
D&O Indemnified Parties	Section 6.4(a)
D&O Insurance	Section 6.4(b)
D&O Tail	Section 6.4(b)
Develop	Section 1.1
Development	Section 1.1
Disclosure Letter	Section 1.1
Dissenting SPAC Shareholders	Section 2.6(a)
Dissenting SPAC Shares	Section 2.6(a)
DTC	Section 1.1
Encumbrance	Section 1.1
Enforceability Exceptions	Section 3.5(a)
Environmental Laws	Section 1.1
Equity Securities	Section 1.1
ERISA	Section 1.1
ERISA Affiliate	Section 1.1
ESOP	Section 1.1
Event	Section 1.1
Exchange Act	Section 1.1
Exchange Agent	Section 2.4(a)
First Merger	Recitals
First Merger Effective Time	Section 2.2(c)(i)
First Merger Filing Documents	Section 2.2(c)(i)
Forward Purchase Agreements	Recitals
Forward Purchase Investment Amount	Section 4.17(a)

Forward Purchase Investors	Recitals
Forward Purchase Subscriptions	Recitals
Fully-Diluted Company Shares	Section 1.1
GAAP	Section 1.1
Government Official	Section 1.1
Governmental Authority	Section 1.1
Governmental Order	Section 1.1
Group	Section 1.1
Group Company(ies)	Section 1.1
Hong Kong	Section 1.1
Indebtedness	Section 1.1
Intellectual Property	Section 1.1
Interim Financial Statements	Section 6.6(a)
Interim Period	Section 6.1
Investment Company Act	Section 1.1
IPO	Section 11.1
JOBS Act	Section 4.14
Knowledge of SPAC	Section 1.1
Knowledge of the Company	Section 1.1
Law	Section 1.1
Leased Real Property	Section 1.1
Letter of Transmittal	Section 2.4(b)
Liabilities	Section 1.1
Made Available	Section 1.1
Major Customers	Section 1.1
Major Suppliers	Section 1.1
Maples	Section 11.19(b)
Material Contracts	Section 1.1
Material Permits	Section 3.7(g)
Maximum Annual Premium	Section 6.4(b)
Merger Consideration	Section 1.1
Merger Filing Documents	Section 2.2(c)(ii)
Merger Sub I	Preamble
Merger Sub I Share	Section 5.2(a)
Merger Sub I Written Resolutions	Recitals
Merger Sub II	Preamble
Merger Sub II Share	Section 5.2(a)
Merger Sub II Written Resolutions	Recitals
Merger Sub(s)	Preamble
Merger Sub Shares	Section 5.2(a)
Mergers	Recitals
NDA	Section 1.1
Non-Recourse Party(ies)	Section 11.17
Non-Redeeming SPAC Shares	Section 1.1

Ordinary Course	Section 1.1
Organizational Documents	Section 1.1
Owned IP	Section 1.1
Patents	Section 1.1
Permitted Encumbrances	Section 1.1
Permitted Equity Financing Proceeds	Section 1.1
Person	Section 1.1
PFIC	Section 1.1
Plan of First Merger	Section 2.2(c)(i)
Plan of Second Merger	Section 2.2(c)(ii)
Plans of Merger	Section 1.1
Prohibited Person	Section 1.1
Proxy/Registration Statement	Section 8.2(a)(i)
Proxy Statement	Section 1.1
Public Notice 7	Section 1.1
Public Notice 7 Tax	Section 1.1
Qualified Electing Fund	Section 8.4(c)
Redeeming SPAC Shares	Section 1.1
Redemption Rate	Section 1.1
Registered IP	Section 1.1
Registrable Securities	Section 1.1
Registration Statement	Section 1.1
Regulatory Approvals	Section 8.1(a)
Regulatory Authority	Section 1.1
Related Party	Section 1.1
Remaining Trust Fund Proceeds	Section 2.3(b)(vii)(2)
Representatives	Section 1.1
Required Governmental Authorization	Section 1.1
Share Consolidation	Section 2.1(a)(ii)
Share Consolidation Effective Time	Section 2.1(a)(iii)
Share Consolidation Factor	Section 1.1
Sanctions	Section 1.1
Sarbanes-Oxley Act	Section 1.1
SEC	Section 1.1
Second Merger	Recitals
Second Merger Effective Time	Section 2.2(c)(ii)
Second Merger Filing Documents	Section 2.2(c)(ii)
Securities Act	Section 1.1
Shareholder Litigation	Section 8.5
Shareholder Support Agreement	Recitals
Shareholders Agreement	Section 1.1
SMH Group	Section 11.19(a)
SMIH	Section 4.16
SMIHU	Section 4.16

SMIHW	Section 4.16
Snow Lake Funds	Recitals
Software	Section 1.1
SPAC	Preamble
SPAC Accounts Date	Section 1.1
SPAC Acquisition Proposal	Section 1.1
SPAC Board	Recitals
SPAC Board Recommendation	Section 8.2(b)(ii)
SPAC Charter	Section 1.1
SPAC Class A Exchange Ratio	Section 1.1
SPAC Class A Ordinary Shares	Section 1.1
SPAC Class B Ordinary Shares	Section 1.1
SPAC Director	Section 2.2(g)
SPAC Disclosure Letter	Article IV
SPAC Financial Statements	Section 4.7(a)
SPAC Insiders	Recitals
SPAC Material Adverse Effect	Section 1.1
SPAC Ordinary Shares	Section 1.1
SPAC Preference Shares	Section 1.1
SPAC SEC Filings	Section 4.12
SPAC Securities	Section 1.1
SPAC Shareholder	Section 1.1
SPAC Shareholder Redemption Amount	Section 1.1
SPAC Shareholder Redemption Right	Section 1.1
SPAC Shareholders' Approval	Section 1.1
SPAC Shareholders' Meeting	Section 8.2(b)(i)
SPAC Shares	Section 1.1
SPAC Transaction Expenses	Section 1.1
SPAC Unit	Section 1.1
SPAC Warrant	Section 1.1
Sponsor	Recitals
Subsidiary	Section 1.1
Surviving Company	Recitals
Surviving Entity	Recitals
Tax(es)	Section 1.1
Tax Returns	Section 1.1
Terminating Company Breach	Section 10.1(f)
Terminating SPAC Breach	Section 10.1(g)
Trade Secrets	Section 1.1
Trademarks	Section 1.1
Transaction Document(s)	Section 1.1
Transaction Proposals	Section 1.1
Transactions	Section 1.1
Transfer Taxes	Section 1.1

Treasury Regulations	Section 1.1
Trust Account	Section 4.13
Trust Agreement	Section 4.13
Trustee	Section 4.13
U.S.	Section 1.1
Underwriting Agreement	Section 1.1
Union	Section 1.1
Unit Separation	Section 2.2(h)(i)
Warrant Agreement	Section 1.1
Warrant Assignment Agreement	Recitals
Working Capital Loan	Section 1.1
Written Objection	Section 2.6(c)
WSGR	Section 11.19(b)
YSB Group	Section 11.19(b)

## BUSINESS COMBINATION AGREEMENT

THIS BUSINESS COMBINATION AGREEMENT, dated as of September 29, 2022 (this “*Agreement*”), is made and entered into by and among (i) YishengBio Co., Ltd., an exempted company limited by shares incorporated under the laws of the Cayman Islands (the “*Company*”), (ii) Oceanview Bioscience Acquisition Co., Ltd., an exempted company limited by shares incorporated under the laws of the Cayman Islands and a direct wholly owned subsidiary of the Company (“*Merger Sub I*”), (iii) Hudson Biomedical Group Co., Ltd., an exempted company limited by shares incorporated under the laws of the Cayman Islands and a direct wholly owned subsidiary of the Company (“*Merger Sub II*”, collectively with Merger Sub I, the “*Merger Subs*” and each, a “*Merger Sub*”), and (iv) Summit Healthcare Acquisition Corp., an exempted company limited by shares incorporated under the laws of the Cayman Islands (“*SPAC*”).

### RECITALS

WHEREAS, the Company, through its wholly owned or Controlled (as defined below) subsidiaries, is engaged in the discovery, development, manufacture and commercialization of vaccines and therapeutic biologics for infectious diseases and cancer.

WHEREAS, SPAC is a blank check company and was incorporated as a Cayman Islands exempted company for the purpose of effecting a merger, share exchange, asset acquisition, share purchase, reorganization or similar business combination with one or more businesses;

WHEREAS, each of Merger Sub I and Merger Sub II is a newly incorporated Cayman Islands exempted company limited by shares wholly owned by the Company, and was incorporated for the purpose of effectuating the Mergers (as defined below);

WHEREAS, the parties hereto desire and intend to effect a business combination transaction whereby (i) immediately prior to the First Merger Effective Time (as defined below), the Company and its shareholders will restructure the Company’s share capital by effectuating the Conversion and the Share Consolidation (the Conversion and the Share Consolidation are described in Section 2.1(a) and hereinafter collectively referred to as the “*Company Capital Restructuring*”), (ii) promptly following the Company Capital Restructuring and at the First Merger Effective Time, Merger Sub I will merge with and into SPAC (the “*First Merger*”), with SPAC surviving the First Merger as a wholly-owned subsidiary of the Company (SPAC, as the surviving entity of the First Merger, is sometimes referred to herein as the “*Surviving Entity*”), and (iii) promptly following the First Merger and at the Second Merger Effective Time (as defined below), the Surviving Entity will merge with and into Merger Sub II (the “*Second Merger*”, together with the First Merger, the “*Mergers*”), with Merger Sub II surviving the Second Merger as a wholly-owned subsidiary of the Company (Merger Sub II, as the surviving entity of the Second Merger, is sometimes referred to herein as the “*Surviving Company*”), with each of the Company Capital Restructuring, the First Merger and the Second Merger to occur upon the terms and subject to the conditions set forth in this Agreement and in accordance with Part XVI of the Companies Act (As Revised) of the Cayman Islands (the “*Cayman Act*”);

WHEREAS, pursuant to certain Forward Purchase Agreements dated as of April 30, 2021 relating to SPAC (the “*Forward Purchase Agreements*”), among other things, (a) certain investment funds managed by Snow Lake Capital (HK) Limited, a Hong Kong private company limited by shares (the “*Snow Lake Funds*”), have agreed to purchase 2,000,000 SPAC Class A Ordinary Shares and 500,000 SPAC Warrants for an aggregate price equal to \$20,000,000 immediately prior to the First Merger Effective Time and (b) The Valliance Fund (together with the Snow Lake Funds and any of their respective successors or transferees pursuant to the Forward Purchase Agreements, the “*Forward Purchase Investors*”) has agreed to purchase 1,000,000 SPAC Class A Ordinary Shares and 250,000 SPAC Warrants for an aggregate price equal to \$10,000,000 immediately prior to the First Merger Effective Time (the purchases referred to in clauses (a) and (b) of this paragraph, the “*Forward Purchase Subscriptions*”);

WHEREAS, concurrently with the execution and delivery of this Agreement, the Company, SPAC, certain Company Shareholders (who constitute the holders of at least a majority of the outstanding Company Ordinary Shares and the Majority Preferred Holders (as defined in the Company Charter)), Summit Healthcare Acquisition Sponsor LLC, a Cayman Islands limited liability company (“*Sponsor*”) and certain other Persons identified therein (together with Sponsor, the “*SPAC Insiders*”) have entered into and delivered

the Shareholder Support Agreement and Deed substantially in the form attached hereto as Exhibit A (the “**Shareholder Support Agreement**”), pursuant to which, among other things, and subject to the terms and conditions set forth therein,

(A) Sponsor agrees (a) to surrender 1,446,525 SPAC Class B Ordinary Shares for nil consideration immediately prior to the First Merger Effective Time and exchange all of the remaining SPAC Shares held by it into Company Ordinary Shares on a one-for-one basis at the First Merger Effective Time (b) to vote all SPAC Shares held by Sponsor in favor of (i) the Transactions and (ii) the other Transaction Proposals, (c) to waive the anti-dilution rights of the SPAC Class B Ordinary Shares under the SPAC Charter, (d) to appear and be present at the SPAC Shareholders’ Meeting in person or by proxy for purposes of counting towards a quorum, (e) to vote all SPAC Shares held by Sponsor against any proposals that would or would be reasonably likely to in any material respect impede the Transactions or any other Transaction Proposal, (f) not to redeem any SPAC Shares held by Sponsor, (g) not to amend that certain letter agreement between SPAC, Sponsor and certain other parties thereto, dated as of June 8, 2021, (h) not to transfer any SPAC Shares held by Sponsor, (i) to unconditionally and irrevocably waive, and not to exercise, the Sponsor’s dissenters’ rights pursuant to the Cayman Act in respect of all SPAC Shares held by Sponsor with respect to the First Merger, to the extent applicable, (j) to, together with other SPAC Insiders, a lock-up of the Company Ordinary Shares received by them in the Mergers for a one-year period after the First Merger Effective Time, subject to certain exceptions set forth therein, and (k) to terminate, effective, as of the First Merger Effective Time, the registration and shareholder rights agreement dated as of June 8, 2021 relating to SPAC; and

(B) the applicable Company Shareholders agree (a) to vote all Company Shares held by such Company Shareholders in favor of the Transactions, (b) to appear and be present at the Company Shareholders’ Meeting in person or by proxy for purposes of counting towards a quorum, (c) to vote all Company Shares held by such Company Shareholders against any proposals that would or would be reasonably likely to in any material respect impede the Transactions, (d) during the period from the date of this Agreement to the earlier of the Closing or the termination of this Agreement, not to transfer or exercise redemption rights with respect to any Company Shares held by such Company Shareholders, subject to certain exceptions set forth therein, (e) to unconditionally and irrevocably waive, and not to exercise, the dissenters’ rights pursuant to the Cayman Act in respect of all Company Shares held by such Company Shareholders with respect to the Mergers, and (f) not to transfer Company Ordinary Shares held by such Company Shareholders for a 180-day period after the First Merger Effective Time, subject to certain exceptions set forth therein; and

(C) the Company and the applicable Company Shareholders agree to amend the Shareholders Agreement (as defined below), effective as of the First Merger Effective Time, to (a) grant the SPAC Insiders registration rights on a *pari passu* basis as the Company Shareholders and (b) grant Sponsor the right to appoint two directors on the board of directors of the Company so long as Sponsor beneficially owns not less than 1% of all the issued and outstanding shares of the Company;

**WHEREAS**, concurrently with the execution and delivery of this Agreement, the Company, SPAC and the warrant agent thereunder have entered into a warrant assignment agreement substantially in the form attached hereto as Exhibit B (the “**Warrant Assignment Agreement**”) pursuant to which SPAC assigns to the Company all of its rights, interests, and obligations in and under the Warrant Agreement, which amends the Warrant Agreement to change all references to Warrants (as such term is defined therein) to Company Warrants (and all references to Ordinary Shares (as such term is defined therein) underlying such Warrants to Company Ordinary Shares after the consummation of the Company Capital Restructuring) and which causes each outstanding whole Company Warrant to represent the right to receive, from the Closing, one whole Company Ordinary Share;

**WHEREAS**, the board of directors of SPAC (the “**SPAC Board**”) has unanimously (a) determined that (x) it is fair to, advisable and in the best interests of SPAC to enter into this Agreement, and to consummate the Mergers and the other Transactions, and (y) the Transactions constitute a “**Business Combination**” as such term is defined in the SPAC Charter, (b) (i) approved and declared advisable this Agreement and the execution, delivery and performance of this Agreement and the consummation of the Transactions (including the Mergers), and (ii) approved and declared advisable to enter into the Plan of First Merger, the Plan of Second Merger, the Shareholder Support Agreement, the Warrant Assignment Agreement and the execution, delivery

and performance thereof, (c) resolved to recommend the approval and authorization of this Agreement, the Plan of First Merger and the Plan of Second Merger, the consummation of the Mergers and the other Transactions by the shareholders of SPAC, and (d) directed that this Agreement, the Plan of First Merger and the Plan of Second Merger be submitted to the shareholders of SPAC for their consideration, and if thought fit, approval and authorization;

**WHEREAS**, (a) the sole director of Merger Sub I has (i) determined that it is fair to, advisable and in the best interests of Merger Sub I to enter into this Agreement and to consummate the First Merger and the other Transactions, (ii) approved and declared advisable this Agreement and the Plan of First Merger and the execution, delivery and performance of this Agreement and the Plan of First Merger and the consummation of the Transactions and (b) the Company, being the sole shareholder of Merger Sub I, has passed special resolutions by written resolutions approving the entry into of this Agreement, and approving and authorizing the Plan of First Merger and the Transactions (clauses (a) and (b), collectively, the “*Merger Sub I Written Resolutions*”);

**WHEREAS**, (a) the sole director of Merger Sub II has (i) determined that it is fair to, advisable and in the best interests of Merger Sub II to enter into this Agreement and to consummate the Second Merger and the other Transactions, (ii) approved and declared advisable this Agreement and the Plan of Second Merger and the execution, delivery and performance of this Agreement and the Plan of Second Merger and the consummation of the Transactions and (b) the Company, being the sole shareholder of Merger Sub II, passed special resolutions by written resolutions approving the entry into of this Agreement, and approving and authorizing the Plan of Second Merger and the Transactions (clauses (a) and (b), collectively, the “*Merger Sub II Written Resolutions*”); and

**WHEREAS**, the board of directors of the Company (the “*Company Board*”) has unanimously (i) determined that it is fair to, advisable and in the best interests of the Company to enter into this Agreement and to consummate the Mergers and the other Transactions, (ii) (x) approved and declared advisable this Agreement and the execution, delivery and performance of this Agreement and the consummation of the Transactions, and (y) approved and declared advisable the Shareholder Support Agreement, the Warrant Assignment Agreement and the execution, delivery and performance thereof, (iii) resolved to recommend the approval and authorization of this Agreement by the shareholders of the Company, and (iv) directed that this Agreement and the Mergers be submitted to the shareholders of the Company for their approval and authorization; and

**WHEREAS**, the shareholders of the Company (including the Majority Preferred Holders, as defined in the Company Charter) have (i) determined that it is fair to, advisable and in the best interests of the Company to enter into this Agreement and to consummate the Company Capital Restructuring, the Mergers and the other Transactions, (ii) approved and authorized this Agreement, the Shareholder Support Agreement, the Warrant Assignment, the Plans of Merger and the execution, delivery and performance of thereof and the consummation of the Transactions, in accordance with the Company Charter and (iii) approved and adopted the Amended Company Charter and the Amended Company Incentive Plan (each as defined below), in each case effective immediately prior to the First Merger Effective Time.

**NOW, THEREFORE**, in consideration of the foregoing and the respective representations, warranties, covenants and agreements set forth in this Agreement and intending to be legally bound hereby, the Company, SPAC and the Merger Subs agree as follows:

## ARTICLE I

### CERTAIN DEFINITIONS

**Section 1.1 Definitions.** As used herein, the following terms shall have the following meanings:

“*Action*” means any charge, claim, action, complaint, petition, prosecution, investigation, appeal, suit, litigation, arbitration or other similar proceeding initiated or conducted by a mediator, arbitrator or Governmental Authority, whether administrative, civil, regulatory or criminal, and whether at law or in equity, or otherwise under any applicable Law;

“*Affiliate*” means, with respect to any Person, any other Person which, directly or indirectly, Controls, is Controlled by or is under common Control with such Person. In the case of a Person which is a fund or which



is directly or indirectly Controlled by a fund, and the term “*Affiliate*” also includes (a) any of the general partners of such fund, (b) the fund manager managing such fund, any other person which, directly or indirectly, Controls such fund or such fund manager, or any other funds managed by such fund manager and (c) trusts (excluding the Trust Account for all purposes other than for the sole purpose of the release of the proceeds of the Trust Account in accordance with this Agreement and the Trust Agreement) Controlled by or for the benefit of any Person referred to in (a) or (b);

“*Anti-Money Laundering Laws*” means all financial recordkeeping and reporting requirements and all money laundering-related laws of jurisdictions where the Company or its Subsidiaries conducts business or owns assets, and any related or similar Law issued, administered or enforced by any Governmental Authority;

“*Available Closing Cash Amount*” means, without duplication, an amount equal to (a) all amounts in the Trust Account immediately prior to the Closing plus (b) the aggregate amount of cash that has been funded to, or that will be funded immediately prior to or concurrently with the Closing to, SPAC pursuant to the Forward Purchase Agreements plus (c) the Permitted Equity Financing Proceeds (excluding any proceeds that will be invested by existing shareholders or creditors of the Company immediately prior to the First Merger Effective Time) *minus* (d) the SPAC Shareholder Redemption Amount;

“*Benefit Plan*” means any “employee benefit plan” (as such term is defined in Section 3(3) of ERISA, whether or not subject to ERISA) and compensation or benefit plan, program, policy, practice, Contract, agreement, or other arrangement, including any employment, consulting, severance, termination pay, deferred compensation, retirement, paid time off, vacation, profit sharing, incentive, bonus, health, welfare, performance awards, equity or equity-based compensation (including stock option, equity purchase, equity ownership, and restricted stock unit), disability, death benefit, life insurance, fringe benefits, indemnification, retention or stay-bonus, transaction or change-in control agreement, or other compensation or benefits, whether written, unwritten or otherwise, that is sponsored, maintained, contributed to or required to be contributed to by the Company or its ERISA Affiliates for the benefit of any current or former employee, director or officer or individual service provider of the Company and its Subsidiaries or otherwise with respect to which the Company or its Subsidiaries has any Liability, in each case other than any statutory benefit plan mandated by Law;

“*BofA Waiver Letter*” means the letter dated July 7, 2022 addressed to SPAC from BofA Securities, Inc., waiving its entitlement to the payment of all deferred underwriting commissions to be paid under the terms of the Underwriting Agreement;

“*Business Combination*” has the meaning given in the SPAC Charter;

“*Business Day*” means a day on which commercial banks are open for business in New York, U.S., the Cayman Islands, Hong Kong and the PRC, except a Saturday, Sunday or public holiday (gazetted or ungazetted and whether scheduled or unscheduled);

“*Code*” means the Internal Revenue Code of 1986, as amended;

“*Commercialize*” means activities directed to manufacturing, obtaining pricing and reimbursement approvals for, marketing, promoting, distributing, importing, and/or selling a Company Product, and “*Commercialized*”, “*Commercializing*” and “*Commercialization*” shall be construed accordingly;

“*Company Acquisition Proposal*” means (a) any, direct or indirect, acquisition by any third party, in one transaction or a series of transactions, of the Company or of more than 5% of the consolidated total assets, Equity Securities or businesses of the Company and its Controlled Affiliates taken as a whole (whether by merger, consolidation, scheme of arrangement, business combination, reorganization, recapitalization, purchase or issuance of Equity Securities, purchase of assets, tender offer or otherwise) other than the Transactions; (b) any direct or indirect acquisition by any third party, in one transaction or a series of transactions, of voting Equity Securities representing more than 5%, by voting power, of (x) the Company (whether by merger, consolidation, recapitalization, purchase or issuance of Equity Securities, tender offer or otherwise) or (y) the Company’s Controlled Affiliates which comprise more than 5% of the consolidated total assets, revenues or earning power of the Company and its Controlled Affiliates taken as a whole, in each case, other than the Transactions, (c) any direct or indirect acquisition by any third party, in one transaction or a series of transactions, of more than 5% of the consolidated total assets, revenues or earning power of the

Company and its Controlled Affiliates taken as a whole, other than by SPAC or its Affiliates or pursuant to the Transactions or (d) the issuance by the Company of more than 5% of its voting Equity Securities as consideration for the assets or securities of a third party (whether an entity, business or otherwise), except in any such case as permitted under Section 6.1(3)(c) or Section 6.1(3)(d) or the transactions for the Permitted Equity Financing Proceeds;

“**Company Charter**” means the Amended and Restated Memorandum and Articles of Association of the Company, which was adopted pursuant to a special resolution passed on January 28, 2021 and became effective on January 29, 2021;

“**Company Contract**” means any Contract to which a Group Company is a party or by which a Group Company is bound and for which performance of substantive obligations is ongoing;

“**Company IP**” means all Owned IP and all other Intellectual Property used or held for use in or necessary for the operation of the business of the Company or any of its Subsidiaries;

“**Company Material Adverse Effect**” means any Event that has had, or would reasonably be expected to have, individually or in the aggregate, a material adverse effect on (i) the business, assets and liabilities, results of operations or financial condition of the Company and its Subsidiaries, taken as a whole or (ii) the ability of the Company, any of its Subsidiaries (including the Merger Subs) to consummate the Transactions; **provided, however**, that in no event would any of the following, alone or in combination, be deemed to constitute, or be taken into account in determining whether there has been or will be, a “**Company Material Adverse Effect**”: (a) any change in applicable Laws or GAAP or any interpretation thereof following the date of this Agreement, (b) any change in interest rates or economic, political, business or financial market conditions generally, (c) the taking or refraining from taking of any action expressly required to be taken or refrained from being taken under this Agreement, (d) any natural disaster (including hurricanes, storms, tornados, flooding, earthquakes, volcanic eruptions or similar occurrences), epidemic or pandemic (including any COVID-19 Measures or any change in such COVID-19 Measures or interpretations following the date of this Agreement), acts of nature or change in climate, (e) any acts of terrorism or war, the outbreak or escalation of hostilities, geopolitical conditions, local, national or international political conditions, riots or insurrections, (f) any failure in and of itself of the Company and any of its Subsidiaries to meet any projections or forecasts, **provided, however**, that the exception in this clause (f) shall not prevent or otherwise affect a determination that any change, effect or development underlying such change has resulted in or contributed to a Company Material Adverse Effect, (g) any Events generally applicable to the industries or markets in which the Company or any of its Subsidiaries operate, (h) any action taken by, or at the written request of, SPAC, (i) the announcement of this Agreement and the Transactions, including any termination of, reduction in or similar adverse impact (but in each case only to the extent attributable to such announcement or consummation) on the Company’s and its Subsidiaries’ relationships, contractual or otherwise, with any Governmental Authority, third parties or other Person, (j) any matter set forth on, or deemed to be incorporated in the Company Disclosure Letter, (k) any Events that are cured by the Company prior to the Closing, or (l) any worsening of the Events referred to in clauses (a), (b), (d), (e), (g) or (j) to the extent existing as of the date of this Agreement; **provided, however**, that in the case of each of clauses (b), (d), (e) and (g), any such Event to the extent it disproportionately affects the Company or any of its Subsidiaries relative to other similarly situated participants in the industries and geographies in which such Persons operate shall not be excluded from the determination of whether there has been, or would reasonably be expected to be, a Company Material Adverse Effect, in which case the determination of whether there has been, or would reasonably be expected to be, a Company Material Adverse Effect shall be made only to the extent of the incremental disproportionate effect on the Company and its Subsidiaries, taken as a whole, relative to such similarly situated participants;

“**Company Options**” means all share options to acquire Company Shares issued pursuant to an award granted under the ESOP and outstanding immediately prior to the First Merger Effective Time;

“**Company Ordinary Shares**” means (i) before the Share Consolidation, ordinary shares of the Company, par value \$0.000005 per share, (ii) after the Share Consolidation but before the First Merger Effective Time, ordinary shares of the Company, par value \$0.00002 per share, the rights, preferences, privileges and restrictions of which are as set out in the Company Charter and (iii) from and after the First Merger Effective Time, ordinary shares of the Company, par value \$0.00002 per share, the rights, preferences, privileges and restrictions of which are as set out in the Amended Company Charter;

“**Company Preferred Shares**” means, collectively, the Company Series A Preferred Shares and the Company Series B Preferred Shares prior to the First Merger Effective Time, and for the avoidance of doubt, there shall be no Company Preferred Shares after the First Merger Effective Time;

“**Company Products**” means YSJA™ Rabies Vaccine, PIKA™ Rabies Vaccines, PIKA Covid-19 vaccines, and any improvements or modifications thereto and any follow-on or other vaccines owned, Controlled or Commercialized by the Company or any Group Company (including any of the foregoing currently in Development);

“**Company Series A Preferred Shares**” has the meaning given to that term in the Company Charter, prior to the First Merger Effective Time, and for the avoidance of doubt, there shall be no Company Series A Preferred Shares after the First Merger Effective Time;

“**Company Series B Preferred Shares**” has the meaning given to that term in the Company Charter, prior to the First Merger Effective Time, and for the avoidance of doubt, there shall be no Company Series B Preferred Shares after the First Merger Effective Time;

“**Company Shareholder**” means any holder of any Company Shares immediately prior to the First Merger Effective Time;

“**Company Shares**” means, collectively, Company Ordinary Shares and the Company Preferred Shares;

“**Company Transaction Expenses**” means any out-of-pocket fees and expenses payable by the Company or any of its Subsidiaries (including the Merger Subs and the relevant surviving companies of the Mergers, but excluding the SPAC prior to the First Merger Effective Time) or Affiliates (whether or not billed or accrued for) as a result of or in connection with the negotiation, documentation and consummation of the Transactions, including (a) all fees, costs, expenses, brokerage fees, commissions, finders’ fees and disbursements of financial advisors, investment banks, data room administrators, attorneys, accountants and other advisors and service providers, including consultants and public relations firms, as appointed by the Company, and (b) subject to Section 8.2(a)(i), any and all filing fees payable by the Company or any of its Subsidiaries (including the Merger Subs and the relevant surviving companies of the Mergers, but excluding the SPAC prior to the First Merger Effective Time) or their respective Affiliates to the Governmental Authorities in connection with the Transactions, **provided** that SPAC shall not be deemed as the Company or a Subsidiary of the Company for purpose of this term;

“**Competing SPAC**” means any publicly traded special purpose acquisition company other than SPAC;

“**Contract**” means any legally binding written, oral or other agreement, contract, subcontract, lease, instrument, note, option, warranty, purchase order, license, sublicense, mortgage, guarantee, purchase order, insurance policy or commitment or undertaking of any nature that has any outstanding rights or obligations;

“**Control**” means (i) in relation to any Person (a) the direct or indirect ownership of, or ability to direct the casting of, more than fifty percent (50%) of the total voting rights conferred by all the shares then in issue and conferring the right to vote at all general meetings of such Person; (b) the ability to appoint or remove a majority of the directors of the board or equivalent governing body of such Person; (c) the right to control the votes at a meeting of the board of directors (or equivalent governing body) of such Person; or (d) the ability to direct or cause the direction of the management and policies of such Person whether by Contract or otherwise and (ii) in relation to an item, information, product or an intellectual property right that a Person owns or has a license or other appropriate rights in, to, and under such item, information, or intellectual property right without violating the terms of any written agreement with any third party, and “**Controlled**”, “**Controlling**” and “under common Control with” shall be construed accordingly;

“**COVID-19**” means SARS-CoV-2 or COVID-19, and any evolutions or mutations thereof or related or associated epidemics, pandemics or disease outbreaks;

“**COVID-19 Measures**” means (i) any quarantine, “shelter in place,” “stay at home,” workforce reduction, social distancing, shut down, closure, sequester, safety or similar Law, directive, guidelines or recommendations promulgated by any Governmental Authority, including Centers for Disease Control and Prevention and the World Health Organization, in each case, in connection with or in response to COVID-19 for similarly situated companies, and (ii) any action reasonably taken or refrained from being taken in response to COVID-19;

“**Development**” means non-clinical, pre-clinical and clinical drug discovery, research, and/or development activities, including without limitation quality assurance and quality control development, and any other activities reasonably related to or leading to the development and submission of information to a Regulatory Authority, and “**Develop**” means to engage in Development;

“**Disclosure Letter**” means, as applicable, the Company Disclosure Letter and the SPAC Disclosure Letter;

“**DTC**” means the Depository Trust Company;

“**Encumbrance**” means any mortgage, charge (whether fixed or floating), pledge, lien, license, covenant not to sue, option, right of first offer, refusal or negotiation, hypothecation, assignment, deed of trust, title retention or other similar encumbrance of any kind whether consensual, statutory or otherwise;

“**Environmental Laws**” means all Laws concerning pollution, protection of the environment, or human health or safety;

“**Equity Securities**” means, with respect to any Person, any capital stock, shares, equity interests, membership interests, partnership interests or registered capital, joint venture or other ownership interests in such person and any options, warrants or other securities (for the avoidance of doubt, including debt securities) that are directly or indirectly convertible into, or exercisable or exchangeable for, such capital stock, shares, equity interests, membership interests, partnership interests or registered capital, joint venture or other ownership interests (whether or not such derivative securities are issued by such Person);

“**ERISA**” means the Employee Retirement Income Security Act of 1974, as amended;

“**ERISA Affiliate**” of any entity means each entity that is or was at any time treated as a single employer with such entity for purposes of Section 4001(b)(1) of ERISA or Section 414 of the Code;

“**ESOP**” means the 2020 Share Incentive Plan of the Company adopted and approved on January 28, 2021, as may be amended from time to time;

“**Event**” means any event, state of facts, development, change, circumstance, occurrence or effect;

“**Exchange Act**” means the Securities Exchange Act of 1934, as amended;

“**Fully-Diluted Company Shares**” means, without duplication, (a) the aggregate number of Company Shares (i) that are issued and outstanding immediately prior to the Share Consolidation Effective Time and (ii) that are issuable upon the exercise of all options, warrants, convertible notes and other Equity Securities of the Company that are issued and outstanding immediately prior to the Company Capital Restructuring excluding the 26,626,329 Company Shares reserved for future issuance under the ESOP (whether or not then awarded, vested or exercisable, as applicable), *minus* (b) the Company Shares held by the Company or any Subsidiary of the Company (if applicable) as treasury shares.

“**GAAP**” means generally accepted accounting principles in the United States as in effect from time to time;

“**Government Official**” means any officer, cadre, civil servant, employee or any other person who acts in an official capacity for any Governmental Authority (including any government-owned or government-Controlled enterprise, political party, public international organization or official thereof), or who acts in an official capacity for any candidate for governmental or political office;

“**Governmental Authority**” means the government of any nation, province, state, city, locality or other political subdivision of any thereof, any entity exercising executive, legislative, judicial, regulatory, taxing or administrative functions of or pertaining to government, regulation or compliance, or any arbitrator or arbitral body, any self-regulated organization, stock exchange, or quasi-governmental authority;

“**Governmental Order**” means any applicable order, ruling, decision, verdict, decree, writ, subpoena, mandate, precept, command, directive, consent, approval, award, judgment, injunction or other similar determination or finding by, before or under the supervision of any Governmental Authority;

“**Group**” or “**Group Companies**” means the Company and its Subsidiaries, and “**Group Company**” means any of them;

“**Hong Kong**” means the Hong Kong Special Administrative Region of the People’s Republic of China;

“**Indebtedness**” means with respect to any Person, without duplication, any obligations, contingent or otherwise, in respect of (a) the principal of and premium (if any) in respect of all indebtedness for borrowed money, including accrued interest and any per diem interest accruals, including any amount due to any shareholder of such Person, (b) the principal and accrued interest components of capitalized lease obligations under GAAP, (c) amounts drawn (including any accrued and unpaid interest) on letters of credit, bank guarantees, bankers’ acceptances and other similar instruments (solely to the extent such amounts have actually been drawn), (d) the principal of and premium (if any) in respect of obligations evidenced by bonds, debentures, notes and similar instruments, (e) the termination value of interest rate protection agreements and currency obligation swaps, hedges or similar arrangements (without duplication of other indebtedness supported or guaranteed thereby), (f) the principal component of all obligations to pay the deferred and unpaid purchase price of property and equipment which have been delivered, including “earn outs,” “seller notes,” “exit fees” and “retention payments,” but excluding payables arising in the Ordinary Course, (g) breakage costs, prepayment or early termination premiums, penalties, or other fees or expenses payable as a result of the consummation of the Transactions in respect of any of the items in the foregoing clauses (a) through (f), and (h) all Indebtedness of another Person referred to in clauses (a) through (g) above guaranteed directly or indirectly, jointly or severally;

“**Intellectual Property**” means all intellectual property, industrial property and proprietary rights in any and all jurisdictions worldwide, including rights in: (a) Patents, (b) Trademarks, (c) copyrights, works of authorship and mask works, (d) Trade Secrets, (e) Software, (f) “moral” rights, rights of publicity or privacy, data base or data collection rights and other similar intellectual property rights, (g) registrations, applications, and renewals for any of the foregoing in (a)-(f), and (h) all rights in the foregoing;

“**Investment Company Act**” means the Investment Company Act of 1940, as amended;

“**Knowledge of SPAC**” or any similar expression means the knowledge that each individual listed on Section 1.1 of the SPAC Disclosure Letter actually has, or the knowledge that any such individual would have acquired following reasonable inquiry of his or her direct reports directly responsible for the applicable subject matter;

“**Knowledge of the Company**” or any similar expression means the knowledge that each individual listed on Section 1.1 of the Company Disclosure Letter actually has, or the knowledge that any such individual would have acquired following reasonable inquiry of his or her direct reports directly responsible for the applicable subject matter;

“**Law**” means any statute, law, ordinance, rule, regulation or Governmental Order, in each case, of any Governmental Authority, or any provisions or interpretations of the foregoing, including general principles of common and civil law and equity;

“**Leased Real Property**” means any real property subject to a Company Lease;

“**Liabilities**” means debts, liabilities and obligations (including Taxes), whether accrued or fixed, absolute or contingent, matured or unmatured, deferred or actual, determined or determinable, known or unknown, including those arising under any law, action or Governmental Order and those arising under any Contract;

“**Made Available**” means, unless the context otherwise requires, that a copy of the subject documents or other materials has been provided physically or electronically by the Company, its Subsidiary or any of their respective Representatives at least two (2) Business Days prior to the date hereof, either by email or through virtual data room;

“**Major Customers**” means the top five (5) customers of the Group for the past twelve (12) months ended on March 31, 2022, listed on Section 1.1 of the Company Disclosure Letter;

“**Major Suppliers**” means the top five (5) suppliers of the Group for the past twelve (12) months ended on March 31, 2022, listed on Section 1.1 of the Company Disclosure Letter;

“**Material Contracts**” means, collectively, each Contract (other than any Benefit Plan) that:

(i) involves contractual amount of obligations (contingent or otherwise), payments or revenues to or by the Group or SPAC, as applicable, in excess of \$2,000,000;

(ii) is with a Related Party (other than those employment agreements, indemnification agreements, Contracts covered by any Benefit Plan, confidentiality agreements, non-competition agreements or any other agreement of similar nature entered into in the Ordinary Course with employees or technical consultants) with an amount of over \$120,000;

(iii) involves (A) indebtedness for borrowed money having an outstanding principal amount in excess of \$1,000,000 or (B) an extension of credit, a guaranty, surety, deed of trust, or the grant of an Encumbrance, in each case, to secure any Indebtedness having a principal or stated amount in excess of \$1,000,000;

(iv) involves the lease, license, sale, use, disposition or acquisition of a business or assets constituting a business involving purchase price, payments or revenues in excess of \$1,000,000 or involving any “earn out” or deferred purchase price payment obligation;

(v) involves the waiver, compromise, or settlement of any dispute, claim, litigation or arbitration with an amount higher than \$200,000;

(vi) grants a right of first refusal, right of first offer or similar right with respect to any material properties, assets or businesses of the Company and its Subsidiaries, or SPAC, as applicable, taken as a whole;

(vii) contains covenants of the Company or any of the Company’s Subsidiaries or SPAC, as applicable, (A) prohibiting or limiting the right of the Company or any of the Company’s Subsidiaries or SPAC, as applicable, to engage in or compete with any Person in any line of business in any material respect or (B) prohibiting or restricting the ability of the Company and the Company’s Subsidiaries or SPAC, as applicable, to conduct their respective business with any Person in any geographic area in any material respect, in each case, other than Contracts (including partnership or distribution Contracts) entered into in the Ordinary Course which include exclusivity provisions;

(viii) with each of the Major Customers involving payments to the Group or the SPAC, as applicable, in the twelve (12) months ended March 31, 2022 in excess of \$1,000,000;

(ix) with each of the Major Suppliers involving payments to the Group or the SPAC, as applicable, in the twelve (12) months ended March 31, 2022 in excess of \$1,000,000;

(x) with any Governmental Authority which involves obligations (contingent or otherwise), payments or revenues to or by the Group or SPAC, as applicable, in excess of \$200,000 in the twelve (12) months ended March 31, 2022, other than Contracts made in the Ordinary Course;

(xi) involves (x) the establishment, contribution to, or operation of a partnership, joint venture, alliance, collaboration, variable interest entity or similar entity, or involving a sharing of profits or losses (including joint development Contracts), or (y) a material business cooperation, technology development or similar arrangement between any Group Company or SPAC, as applicable, and any medical institution, scientific research institution or university, in any such case involving payments to or by the Group or SPAC, as applicable, of an amount higher than \$1,000,000 in the twelve (12) months ended March 31, 2022;

(xii) relates to the license, sublicense, grant of other rights, creation, development, or acquisition of material Intellectual Property, or materially restricts the ability of the Company or any of its Subsidiaries, or SPAC, as applicable, to assign, use or enforce any material Intellectual Property, other than (A) non-exclusive end user licenses of commercially-available, off-the-shelf Software used solely for the internal use of the Company or any of its Subsidiaries or SPAC, as applicable, and with a total replacement cost of less than \$200,000 and (B) assignments of Intellectual Property to the Company or any of its Subsidiaries or SPAC, as applicable, under Contracts with their employees entered into in the Ordinary Course and containing Intellectual Property assignment and confidentiality provisions that are equivalent in all material respects to the form employment agreements of the Company’s and its Subsidiaries or SPAC, as applicable; or

(xiii) is a collective bargaining agreement with a Union.

“**Merger Consideration**” means the sum of all Company Ordinary Shares receivable by SPAC Shareholders pursuant to Section 2.2(h)(ii);

“**NDA**” means the Non-Disclosure Agreement, dated as of May 11, 2022, between SPAC and the Company;

“**Non-Redeeming SPAC Shares**” means, without duplication, (a) 375,000 SPAC Class B Ordinary Shares held by the Forward Purchase Investors, (b) 3,000,000 SPAC Class A Ordinary Shares to be purchased by the Forward Purchase Investors pursuant to the Forward Purchase Agreements and (c) SPAC Ordinary Shares in respect of which the holder thereof is eligible (as determined in accordance with the SPAC Charter) and has not validly exercised (or has validly revoked, withdrawn or lost) his, her or its SPAC Shareholder Redemption Right, excluding (i) Redeeming SPAC Shares and (ii) Dissenting SPAC Shares;

“**Ordinary Course**” means, with respect to an action taken or refrained from being taken by a Person, that such action or omission is taken in the ordinary course of the operations of such Person, including any COVID-19 Measures and any change in such COVID-19 Measures or interpretations whether taken prior to or following the date of this Agreement;

“**Organizational Documents**” means, with respect to any Person that is not an individual, its certificate of incorporation or registration, bylaws, memorandum and articles of association, constitution, limited liability company agreement, or similar organizational documents, in each case, as amended or restated;

“**Owned IP**” means all Intellectual Property owned by the Company or any of its Subsidiaries;

“**Patents**” means patents, including utility models, industrial designs and design patents, and applications therefor (and any patents that issue as a result of those patent applications), and including all divisionals, continuations, continuations-in-part, continuing prosecution applications, substitutions, reissues, re-examinations, renewals, provisionals and extensions thereof, and any counterparts worldwide claiming priority therefrom;

“**Permitted Encumbrances**” means (a) Encumbrances for Taxes, assessments, and governmental charges or levies not yet due and payable or that are being contested in good faith by appropriate proceedings and for which adequate reserves have been established in accordance with GAAP; (b) mechanics’, carriers’, workmen’s, repairmen’s, materialmen’s or other Encumbrances arising or incurred in the Ordinary Course in respect of amounts that are not yet due and payable; (c) rights of any third parties that are party to or hold an interest in any Contract to which the Company or any of its Subsidiaries is a party; (d) defects or imperfections of title, easements, encroachments, covenants, rights-of-way, conditions, matters that would be apparent from a physical inspection or current, accurate survey of such real property, restrictions and other similar charges or Encumbrances that do not materially interfere with the present use of the Leased Real Property, (e) with respect to any Leased Real Property (i) the interests and rights of the respective lessors with respect thereto, including any statutory landlord liens and any Encumbrances thereon, (ii) any Encumbrances permitted under the Company Lease, and (iii) any Encumbrances encumbering the real property of which the Leased Real Property is a part, (iv) zoning, building, entitlement and other land use and environmental regulations promulgated by any Governmental Authority that do not materially interfere with the current use of the Leased Real Property, (f) licenses of Intellectual Property granted by the Company or any of its Subsidiaries in the Ordinary Course, (g) Ordinary Course purchase money Encumbrances and Encumbrances securing rental payments under operating or capital lease arrangements for amounts not yet due or payable, (h) other Encumbrances arising in the Ordinary Course and not incurred in connection with the borrowing of money and on a basis consistent with past practice in connection with workers’ compensation, unemployment insurance or other types of social security, (i) reversionary rights in favor of landlords under any Company Leases with respect to any of the buildings or other improvements owned by the Company or any of its Subsidiaries, and (j) any other Encumbrances that have been incurred or suffered in the Ordinary Course and do not materially impair the existing use of the property affected by such Encumbrance;

“**Permitted Equity Financing Proceeds**” means cash proceeds to be funded prior to or concurrently with the Closing to the Company or SPAC pursuant to an agreement agreed by SPAC and the Company in writing with an investor after the date hereof, pursuant to which such investor has agreed to purchase for cash Equity Securities from the Company or SPAC prior to or concurrently with the Closing;

“**Person**” means any individual, firm, corporation, company, partnership, limited liability company, incorporated or unincorporated association, trust, estate, joint venture, joint stock company, Governmental Authority or instrumentality or other entity of any kind;

“**PFIC**” means a “passive foreign investment company” within the meaning of Section 1297(a) of the Code;

“**Plans of Merger**” means collectively, the Plan of First Merger and the Plan of Second Merger;

“**Prohibited Person**” means any Person that is (a) a national or organized under the laws of, or resident in, any U.S. embargoed or restricted country (which, as of the date of this Agreement, consists of Cuba, Iran, North Korea, Syria and the Crimea region of Ukraine), (b) included on any Sanctions-related list of blocked or designated parties (including the United States Commerce Department’s Denied Parties List, Entity List, and Unverified List; the U.S. Department of Treasury’s Specially Designated Nationals and Blocked Persons List, Specially Designated Narcotics Traffickers List, Specially Designated Terrorists List, Specially Designated Global Terrorists List, or the Annex to Executive Order No. 13224; the Department of State’s Debarred List; or any list of Persons subject to sanctions issued by the United Nations Security Council, HM Treasury of the United Kingdom, and the European Union); (c) owned fifty percent or more, directly or indirectly, by a Person included on any Sanctions-related list of blocked or designated parties, as described in clause (b) above; (d) is a Person acting in his or her official capacity as a director, officer, employee, or agent of a Person included on any Sanctions-related list of blocked or designated parties, as described in clause (b) above; or (e) a Person with whom business transactions, including exports and imports, are otherwise restricted by Sanctions, including, in each clause above, any updates or revisions to the foregoing and any newly published rules;

“**Proxy Statement**” means the proxy statement forming part of the Proxy/Registration Statement filed with the SEC, with respect to the SPAC Shareholders’ Meeting and the Transactions, to be used for the purpose of soliciting proxies from SPAC Shareholders to approve the Transaction Proposals;

“**Public Notice 7**” means the Notice Regarding Certain Enterprise Income Tax Matters on Indirect Transfer of Properties by Non-Tax Resident Enterprises (关于非居民企业间接转让财产企业所得税若干问题的公告) (Public Notice [2015] No. 7) issued by the State Taxation Administration of the People’s Republic of China, effective February 3, 2015 (including subsequent amending provisions, as well as any interpretations or procedural rules related thereto);

“**Public Notice 7 Tax**” means any Taxes (including any deduction or withholding) payable to or imposed by the applicable Governmental Authority of the People’s Republic of China with respect to Public Notice 7;

“**Redeeming SPAC Shares**” means SPAC Ordinary Shares in respect of which the eligible (as determined in accordance with the SPAC Charter) holder thereof has validly exercised (and not validly revoked, withdrawn or lost) his, her or its SPAC Shareholder Redemption Right;

“**Redemption Rate**” means a fraction, expressed as a percentage, (i) the numerator of which is the aggregate number of Redeeming SPAC Shares and (ii) the denominator of which is the aggregate number of SPAC Ordinary Shares in respect of which the holder thereof is eligible (as determined in accordance with the SPAC Charter) to exercise his, her or its SPAC Shareholder Redemption Right;

“**Registered IP**” means Owned IP issued by, registered, recorded or filed with, renewed by or the subject of a pending application before any Governmental Authority, Internet domain name registrar or other authority;

“**Registrable Securities**” means (a) the Company Ordinary Shares representing the Merger Consideration, (b) the Company Ordinary Shares issuable upon exercise of the Company Warrants and (c) the Company Warrants;

“**Registration Statement**” means, collectively, a registration statement on Form F-4, or other appropriate form, including any pre-effective or post-effective amendments or supplements thereto, to be filed with the SEC by the Company under the Securities Act with respect to the Registrable Securities;



“**Regulatory Authority**” means any applicable government regulatory authority involved in granting approvals for the conduct of clinical trials or the manufacturing, marketing, sale, reimbursement or pricing of a Company Product in a country or regulatory jurisdiction, including the National Medical Product Administration of the People’s Republic of China, or any successor agency thereto;

“**Related Party**” means (a) any member, shareholder or equity interest holder who, together with its Affiliates, directly or indirectly holds no less than 10% of the total outstanding share capital of the Company or any of its Subsidiaries or SPAC, as applicable (b) any director or officer of the Company or any of its Subsidiaries or SPAC, as applicable in each case of clauses (a) and (b), excluding the Company or any of its Subsidiaries or SPAC;

“**Representatives**” of a Person means, collectively, officers, directors, employees, accountants, consultants, legal counsel, agents and other representatives of such Person or its Affiliates;

“**Required Governmental Authorization**” means all material franchises, approvals, permits, consents, qualifications, certifications, authorizations, licenses, orders, registrations, certificates, variances or other similar permits, rights and all pending applications therefor from or with the relevant Governmental Authority required to operate the business of the Company and any of its Subsidiaries, as currently conducted, in accordance with applicable Law;

“**Sanctions**” means those trade, economic and financial sanctions laws, regulations, embargoes, and restrictive measures (in each case having the force of law) administered, enacted or enforced from time to time by (a) the United States (including the United States Commerce Department’s Denied Parties List, Entity List, and Unverified Lists, the U.S. Department of Treasury’s Specially Designated Nationals and Blocked Persons List, Specially Designated Narcotics Traffickers List, or Specially Designated Terrorists List, Specially Designated Global Terrorists List, or the Annex to Executive Order No. 13224, and the Department of State’s Debarred List), (b) the European Union and enforced by its member states, (c) the United Nations Security Council, (d) Her Majesty’s Treasury of the United Kingdom and (e) any other similar economic sanctions administered by a Governmental Authority;

“**Sarbanes-Oxley Act**” means the Sarbanes-Oxley Act of 2002, as amended;

“**SEC**” means the United States Securities and Exchange Commission;

“**Securities Act**” means the Securities Act of 1933, as amended;

“**Share Consolidation Factor**” means 0.25, which is the quotient obtained by *dividing* (i) \$834,249,950 by (ii) the aggregate number of Fully-Diluted Company Shares (being 333,699,980 as of the date of this Agreement and which, for the avoidance of doubt, shall not increase thereafter due to the issuance of Company Ordinary Shares under the ESOP as permitted by the Transaction Documents) and *further by* (iii) ten dollars (\$10.00);

“**Shareholders Agreement**” means the Shareholders Agreement in respect of the Company, dated as of January 28, 2021, as may be amended and/or restated from time to time;

“**Software**” means all computer software, data, and databases, together with object code, source code, firmware, and embedded versions thereof, and documentation related thereto, together with intellectual property, industrial property and proprietary rights in and to any of the foregoing;

“**SPAC Accounts Date**” means March 31, 2022;

“**SPAC Acquisition Proposal**” means: (a) any, direct or indirect, acquisition, merger, domestication, reorganization, business combination, “initial business combination” under SPAC’s initial IPO prospectus or similar transaction, in one transaction or a series of transactions, involving SPAC or involving all or a material portion of the assets, Equity Securities or businesses of SPAC (whether by merger, consolidation, recapitalization, purchase or issuance of equity securities, purchase of assets, tender offer or otherwise); or (b) any equity or similar investment in SPAC or any of its controlled Affiliates, in each case, other than the Transactions;

“**SPAC Charter**” means the Amended and Restated Memorandum and Articles of Association of the SPAC, adopted pursuant to a special resolution passed on June 8, 2021;

“**SPAC Class A Exchange Ratio**” means a ratio equal to (i) if the Redemption Rate is less than or equal to 85%, the quotient obtained by *dividing* (a) the sum of (x) 2,732,325 and (y) the aggregate number of Non-Redeeming SPAC Shares *by* (b) the aggregate number of Non-Redeeming SPAC Shares, rounded up to the nearest four decimal points and (ii) if the Redemption Rate is more than 85%, 1.4286 (it being understood that the SPAC Class A Exchange Ratio is between 1.1169 and 1.4286, depending on the Redemption Rate);

“**SPAC Class A Ordinary Shares**” means Class A ordinary shares of SPAC, par value \$0.0001 per share, as further described in the SPAC Charter, prior to the First Merger Effective Time, and for the avoidance of doubt, there shall be no SPAC Class A Ordinary Shares after the First Merger Effective Time;

“**SPAC Class B Ordinary Shares**” means Class B ordinary shares of SPAC, par value \$0.0001 per share, as further described in the SPAC Charter, prior to the First Merger Effective Time, and for the avoidance of doubt, there shall be no SPAC Class B Ordinary Shares after the First Merger Effective Time;

“**SPAC Material Adverse Effect**” means any Event that has had, or would reasonably be expected to have, individually or in the aggregate, a material adverse effect on (i) the business, assets and liabilities, results of operations or financial condition of SPAC or (ii) the ability of SPAC to consummate the Transactions; **provided, however**, that in no event would any of the following, alone or in combination, be deemed to constitute, or be taken into account in determining whether there has been or will be, a “**SPAC Material Adverse Effect**”: (a) any change in applicable Laws or GAAP or any interpretation thereof following the date of this Agreement, (b) any change in interest rates or economic, political, business or financial market conditions generally, (c) the taking or refraining from taking of any action expressly required to be taken or refrained from being taken under this Agreement, (d) any natural disaster (including hurricanes, storms, tornados, flooding, earthquakes, volcanic eruptions or similar occurrences), epidemic or pandemic (including any COVID-19 Measures or any change in such COVID-19 Measures or interpretations following the date of this Agreement), acts of nature or change in climate, (e) any acts of terrorism or war, the outbreak or escalation of hostilities, geopolitical conditions, local, national or international political conditions, riots or insurrections, (f) any matter set forth on, or deemed to be incorporated in the SPAC Disclosure Letter, (g) any Events that are cured by SPAC prior to the Closing, (h) any action taken by, or at the written request of, the Company, (i) the announcement of this Agreement and the Transactions, including any termination of, reduction in or similar adverse impact (but in each case only to the extent attributable to such announcement or consummation) on the SPAC’s relationships, contractual or otherwise, with any Governmental Authority, third parties or other Person, (j) any change in the trading price or volume of the SPAC Units, SPAC Ordinary Shares or SPAC Warrants (**provided** that the underlying causes of such changes referred to in this clause (j) may be considered in determining whether there is a SPAC Material Adverse Effect except to the extent such cause is within the scope of any other exception within this definition), or (k) any worsening of the Events referred to in clauses (b), (d), (e) or (f) to the extent existing as of the date of this Agreement; **provided, however**, that in the case of each of clauses (b), (d) and (e), any such Event to the extent it disproportionately affects SPAC relative to other special purpose acquisition companies shall not be excluded from the determination of whether there has been, or would reasonably be expected to be, a SPAC Material Adverse Effect, in which case the determination of whether there has been, or would reasonably be expected to be, a SPAC Material Adverse Effect shall be made only to the extent of the incremental disproportionate effect on SPAC relative to such similarly situated participants. Notwithstanding the foregoing, with respect to SPAC, the number of SPAC Shareholders who exercise their SPAC Shareholder Redemption Right or the failure to obtain SPAC Shareholders’ Approval shall not be deemed to be a SPAC Material Adverse Effect;

“**SPAC Ordinary Shares**” means, collectively, SPAC Class A Ordinary Shares and SPAC Class B Ordinary Shares, prior to the First Merger Effective Time, and for the avoidance of doubt, there shall be no SPAC Ordinary Shares after the First Merger Effective Time;

“**SPAC Preference Shares**” means preference shares of SPAC, par value \$0.0001 per share, as further described in the SPAC Charter, prior to the First Merger Effective Time, and for the avoidance of doubt, there shall be no SPAC Preference Shares after the First Merger Effective Time;

“**SPAC Securities**” means, collectively, the SPAC Shares and the SPAC Warrants;

“**SPAC Shareholder**” means any holder of any SPAC Shares;

“**SPAC Shareholder Redemption Amount**” means the aggregate amount payable with respect to all Redeeming SPAC Shares;

“**SPAC Shareholder Redemption Right**” means the right of an eligible (as determined in accordance with the SPAC Charter) holder of SPAC Ordinary Shares to redeem all or a portion of the SPAC Ordinary Shares held by such holder as set forth in the SPAC Charter in connection with the Transaction Proposals;

“**SPAC Shareholders’ Approval**” means the vote of SPAC Shareholders required to approve the Transaction Proposals, as determined in accordance with applicable Law and the SPAC Charter;

“**SPAC Shares**” means the SPAC Ordinary Shares and SPAC Preference Shares;

“**SPAC Transaction Expenses**” means any out-of-pocket fees and expenses paid or payable by SPAC or Sponsor (whether or not billed or accrued for) as a result of or in connection with the negotiation, documentation and consummation of the Transactions, including (a) all fees (including deferred underwriting fees), costs, expenses, brokerage fees, commissions, finders’ fees and disbursements of financial advisors, investment banks, data room administrators, attorneys, accountants and other advisors and service providers, as appointed by SPAC and Sponsor (b) any Indebtedness of SPAC owed to Sponsor, its Affiliates or its or their respective shareholders or Affiliates (including amounts accrued and outstanding under the Working Capital Loan as of the Closing) and (c) subject to Section 8.2(a)(i), any and all filing fees payable by the SPAC to the Governmental Authorities in connection with the Transactions;

“**SPAC Unit**” means the units issued by SPAC in SPAC’s IPO or the exercise of the underwriters’ overallotment option each consisting of one SPAC Class A Ordinary Share and one-half of a SPAC Warrant;

“**SPAC Warrant**” means all outstanding and unexercised warrants issued by SPAC to acquire SPAC Class A Ordinary Shares, including those to be issued pursuant to the Forward Purchase Agreements;

“**Subsidiary**” means, with respect to a specified Person, any other Person Controlled, directly or indirectly, by such specified Person and, in case of a limited partnership, limited liability company or similar entity, such Person is a general partner or managing member and has the power to direct the policies, management and affairs of such Person, respectively, and in the case of the Company, shall include the Merger Subs, the Surviving Entity and the Surviving Company;

“**Tax**” or “**Taxes**” means all U.S. federal, state, or local or non-U.S. taxes imposed by any Governmental Authority, including all income, gross receipts, license, payroll, employment, excise, severance, stamp, occupation, premium, windfall profits, customs duties, capital stock, ad valorem, value added, inventory, franchise, profits, withholding, social security (or similar), unemployment, disability, real property, personal property, sales, use, transfer, registration, alternative or add-on minimum, or estimated taxes, and including any interest, penalty, or addition thereto;

“**Tax Returns**” means all U.S. federal, state, and local and non-U.S. returns, declarations, computations, notices, statements, claims, reports, schedules, forms, and information returns with respect to Taxes, including any attachment thereto or amendment thereof, required or permitted to be supplied to, or filed with, a Governmental Authority;

“**Trade Secrets**” means all trade secrets and other confidential or proprietary information, know-how and other inventions, processes, models, methodologies and all other information that derives economic value (actual or potential) from not being generally known to other persons who can obtain economic value from its disclosure or use;

“**Trademarks**” means trade names, logos, trademarks, service marks, service names, trade dress, company names, collective membership marks, certification marks, slogans, domain names, social media handles, toll-free numbers, and other indicia of origin, whether or not registerable as a trademark in any given country, together with registrations and applications therefor, and the goodwill associated with any of the foregoing;

“**Transaction Documents**” means, collectively, this Agreement, the NDA, the Forward Purchase Agreements, the Shareholder Support Agreement, the Warrant Assignment Agreement, the Merger Filing Documents and any other agreements, documents or certificates entered into or delivered pursuant hereto or thereto, and the expression “**Transaction Document**” means any one of them;

“**Transaction Proposals**” means the adoption and approval of each proposal reasonably agreed to by SPAC and the Company as necessary or appropriate in connection with the consummation of the Transactions, but in any event including unless otherwise agreed upon in writing by SPAC and the Company: (i) the approval and authorization of this Agreement, the Plans of Merger and the Transactions as a Business Combination, (ii) the approval and authorization of the Mergers and the Plans of Merger, (iii) the adoption and approval of a proposal for the adjournment of the SPAC Shareholders’ Meeting, if necessary, to permit further solicitation and vote of proxies because there are not sufficient votes to approve and adopt any of the foregoing or in order to seek withdrawals from SPAC Shareholders who have exercised their SPAC Shareholder Redemption Right if the number of Redeeming SPAC Shares is such that the condition in Section 9.3(c) would not be satisfied, (iv) the approval and authorization of the Company Capital Restructuring and (v) the approval and authorization of each other proposal that the Nasdaq or the SEC (or staff members thereof) indicates (x) are necessary in its comments to the Proxy/Registration Statement or correspondence related thereto and (y) are required to be approved by the SPAC Shareholders in order for the Closing to be consummated;

“**Transactions**” means, collectively, the Company Capital Restructuring, the Mergers and each of the other transactions contemplated by this Agreement or any of the other Transaction Documents;

“**Transfer Taxes**” means any transfer, documentary, sales, use, real property, stamp, registration, and other similar Taxes, fees, and costs (including any interest or penalty thereto) payable in connection with the Transactions;

“**Treasury Regulations**” means the regulations promulgated under the Code.

“**Underwriting Agreement**” means the underwriting agreement dated June 8, 2021 between SPAC and BofA Securities, Inc;

“**Union**” means any union, works council or other employee representative body;

“**U.S.**” means the United States of America;

“**Warrant Agreement**” means the Warrant Agreement, dated as of June 8, 2021, by and between SPAC and Continental Stock Transfer & Trust Company, a New York corporation, as warrant agent; and

“**Working Capital Loan**” means any loan made to SPAC by any of the Sponsor, an Affiliate of the Sponsor, or any of SPAC’s officers or directors, and evidenced by one or more promissory notes, for the purpose of financing costs incurred in connection with a Business Combination.

#### **Section 1.2 Construction.**

(a) Unless the context of this Agreement otherwise requires or unless otherwise specified, (i) words of any gender shall be construed as masculine, feminine, neuter or any other gender, as applicable; (ii) words using the singular or plural number also include the plural or singular number, respectively; (iii) the terms “hereof,” “herein,” “hereby,” “herewith,” “hereto” and derivative or similar words refer to this entire Agreement; (iv) the terms “Article” or “Section” refer to the specified Article or Section of this Agreement; (v) the terms “Schedule” or “Exhibit” refer to the specified Schedule or Exhibit of this Agreement; (vi) the words “including,” “included,” or “includes” shall mean “including, without limitation;” and shall not be construed to limit any general statement that it follows to the specific or similar items or matters immediately following it; (vii) the word “extent” in the phrase “to the extent” means the degree to which a subject or thing extends and such phrase shall not simply mean “if;” (viii) the word “or” shall be disjunctive but not exclusive; (ix) the word “will” shall be construed to have the same meaning as the word “shall”; (x) unless the context otherwise clearly indicates, each defined term used in this Agreement shall have a comparable meaning when used in its plural or singular form; (xi) words in the singular shall be held to include the plural and vice versa, and words of one gender shall be held to include the other gender as the context requires; (xii) references to “written” or “in writing” include in electronic form; and (xiii) a reference to any Person includes such Person’s predecessors, successors and permitted assigns;

(b) Unless the context of this Agreement otherwise requires, references to statutes shall include all regulations promulgated thereunder and references to statutes or regulations shall be construed as including all statutory and regulatory provisions consolidating, amending or replacing the statute or regulation.

(c) References to “\$”, “dollar”, or “cents” are to the lawful currency of the United States of America.

(d) Whenever this Agreement refers to a number of days or months, such number shall refer to calendar days or months unless Business Days are expressly specified. Time periods within or following which any payment is to be made or act is to be done under this Agreement shall be calculated by excluding the calendar day on which the period commences and including the calendar day on which the period ends, and by extending the period to the next following Business Day if the last calendar day of the period is not a Business Day.

(e) All accounting terms used in this Agreement and not expressly defined in this Agreement shall have the meanings given to them under GAAP.

(f) Unless the context of this Agreement otherwise requires, references to (i) SPAC with respect to periods following the First Merger Effective Time shall be construed to mean the Surviving Entity and vice versa and (ii) Merger Sub II with respect to periods following the Second Merger Effective Time shall be construed to mean the Surviving Company and vice versa.

(g) The table of contents and the section and other headings and subheadings contained in this Agreement and the Exhibits hereto are solely for the purpose of reference, are not part of the agreement of the parties hereto, and shall not in any way affect the meaning or interpretation of this Agreement or any Exhibit hereto.

(h) Unless the context of this Agreement otherwise requires, references to agreements and other documents shall be deemed to include all subsequent amendments and other modifications thereto.

(i) Capitalized terms used in the Exhibits and the Disclosure Letter and not otherwise defined therein have the meanings given to them in this Agreement.

(j) With regard to each and every term and condition of this Agreement, the parties hereto understand and agree that the same has been mutually negotiated, prepared and drafted, and if at any time the parties hereto desire or are required to interpret or construe any such term or condition or any agreement or instrument subject hereto, no consideration shall be given to the issue of which party actually prepared, drafted or requested any term or condition of this Agreement.

## ARTICLE II

### TRANSACTIONS; CLOSING

#### Section 2.1 Pre-Closing Actions.

##### (a) *Restructuring of Company’s Share Capital.*

(i) **Conversion of Company Preferred Shares.** On the Closing Date, immediately prior to the Share Consolidation (as defined below) and the First Merger Effective Time, each Company Preferred Share that is issued and outstanding immediately prior to the First Merger Effective Time shall be converted into Company Ordinary Shares on a one-for-one basis by virtue of and in accordance with the Shareholders Agreement and in compliance with the terms of the Company Charter (the “*Conversion*”).

(ii) **Share Consolidation of Company Ordinary Shares.** On the Closing Date, immediately following the Conversion and prior to the First Merger Effective Time, each Company Ordinary Share (and for the avoidance of doubt, any warrant, right or other security convertible into or exchangeable or exercisable therefor) that is issued and outstanding immediately prior to the First Merger Effective Time shall be converted (or made exchangeable or exercisable) into a number of Company Ordinary Shares determined by multiplying each such Company Ordinary Share by the Share Consolidation Factor (together with the treatment of Company Options set forth in Section 2.1(a)(iii), the “*Share Consolidation*”); **provided**, that no fraction of a Company Ordinary Share will be issued by virtue of the Share Consolidation, and each Company Shareholder that would otherwise be so entitled to a fraction of a Company Ordinary Share (after aggregating all fractional Company Ordinary Shares that otherwise would be received by such Company Shareholder) shall instead be entitled to receive such number of

Company Ordinary Shares to which such Company Shareholder would otherwise be entitled, rounded up to the nearest whole Company Ordinary Share.

(iii) **Treatment of Company Options.** On the Closing Date, immediately following the Share Consolidation, each Company Option outstanding as of the effective time of the Share Consolidation (the “*Share Consolidation Effective Time*”) will, automatically and without any action on the part of any holder of such Company Option or beneficiary thereof, continue to be an option to purchase Company Ordinary Shares (each a “*Continuing Option*”) subject to substantially the same terms and conditions as were applicable to such Company Option immediately before the Share Consolidation Effective Time (including expiration date and exercise provisions), except that: (A) each Continuing Option shall be exercisable for that number of Company Ordinary Shares equal to the product (rounded up to the nearest whole Company Ordinary Share) of (1) the number of Company Ordinary Shares subject to such Company Option immediately before the Share Consolidation Effective Time multiplied by (2) the Share Consolidation Factor; and (B) the per share exercise price for each Company Ordinary Share issuable upon exercise of the Continuing Option shall be equal to the quotient obtained by dividing (1) the exercise price per Company Ordinary Share of such Company Option immediately before the Share Consolidation Effective Time by (2) the Share Consolidation Factor; **provided, however**, that the exercise price and the number of Company Ordinary Shares purchasable under each Continuing Option shall, to the extent applicable, be determined in a manner consistent with the requirements of Section 409A of the Code and the applicable regulations promulgated thereunder; and **provided, further**, that in the case of any Company Option to which Section 422 of the Code applies, the exercise price and the number of Company Ordinary Shares purchasable under such Continuing Option shall be determined in accordance with the foregoing in a manner that satisfies the requirements of Section 424(a) of the Code. On or prior to the Closing Date, the Company shall have taken (or caused to be taken) all such actions as are reasonably necessary or appropriate to effect the transactions contemplated under Section 2.1(a) of this Agreement and shall make all such changes or adjustments as necessary or appropriate to the ESOP in accordance with applicable Laws, the terms of the ESOP and any contracts evidencing Company Options.

(b) *Organizational Documents of the Company.* Immediately prior to the First Merger Effective Time, the Company Charter, as in effect immediately prior to the First Merger Effective Time, shall be amended and restated by their deletion in their entirety and the substitution in their place of the third amended and restated memorandum and articles of association of the Company in the form attached hereto as Exhibit E (the “*Amended Company Charter*”), and, as so amended and restated, shall be the memorandum and articles of association of the Company, until thereafter amended in accordance with the terms thereof and the Cayman Act.

(c) *Forward Purchase Notices.* Prior to the First Merger Effective Time, SPAC shall deliver notices to the Forward Purchase Investors to cause the release of funds from escrow to SPAC immediately prior to the Closing and to cause the Forward Purchase Investors to complete the consummation of their respective Forward Purchase Subscriptions immediately prior to the First Merger Effective Time.

## **Section 2.2 The Mergers.**

(a) *The First Merger.* At the First Merger Effective Time, upon the terms and subject to the conditions of this Agreement and in accordance with the applicable provisions of the Plan of First Merger and the Cayman Act, Merger Sub I and SPAC shall consummate the First Merger, pursuant to which Merger Sub I shall merge with and into SPAC, following which the separate corporate existence of Merger Sub I shall cease and SPAC shall continue as the surviving entity after the First Merger and as a direct, wholly-owned subsidiary of the Company.

(b) *The Second Merger.* At the Second Merger Effective Time, upon the terms and subject to the conditions of this Agreement and in accordance with the applicable provisions of the Plan of Second Merger and the Cayman Act, Merger Sub II and the Surviving Entity shall consummate the Second Merger, pursuant to which the Surviving Entity shall merge with and into Merger Sub II, following which the separate corporate existence of the Surviving Entity shall cease and Merger Sub II shall continue as the surviving entity after the Second Merger and as a direct, wholly-owned subsidiary of the Company.

(c) *Effective Times.* On the terms and subject to the conditions set forth herein, on the Closing Date, following the consummation of the Company Capital Restructuring:

(i) SPAC and Merger Sub I shall execute a plan of merger substantially in the form attached as Exhibit C-1 hereto (the “**Plan of First Merger**”) and such other documents as may be required in accordance with the applicable provisions of the Cayman Act or by any other applicable Law to make the First Merger effective (collectively, the “**First Merger Filing Documents**”), and shall file the Plan of First Merger and other documents as required to effect the First Merger pursuant to the Cayman Act with the Registrar of Companies of the Cayman Islands as provided in the applicable provisions of the Cayman Act. The First Merger shall become effective at the time when the Plan of First Merger is registered by the Registrar of Companies of the Cayman Islands or such later time (being not later than the 90th day after registration by the Registrar of Companies of the Cayman Islands) as Merger Sub I and SPAC may agree and specify pursuant to the Cayman Act (the “**First Merger Effective Time**”) but in all events the First Merger Effective Time shall precede the Second Merger Effective Time.

(ii) Immediately following the consummation of the First Merger at the First Merger Effective Time, the Surviving Entity and Merger Sub II shall execute a plan of merger substantially in the form attached as Exhibit C-2 hereto (the “**Plan of Second Merger**”, and together with the Plan of First Merger, the “**Plans of Merger**”) and such other documents as may be required in accordance with the applicable provisions of the Cayman Act or by any other applicable Law to make the Second Merger effective (collectively, the “**Second Merger Filing Documents**”, and together with the First Merger Filing Documents, the “**Merger Filing Documents**”), and shall file the Plan of Second Merger and other documents as required to effect the Second Merger pursuant to the Cayman Act with the Registrar of Companies of the Cayman Islands as provided in the applicable provisions of the Cayman Act. The Second Merger shall become effective at the time when the Plan of Second Merger is registered by the Registrar of Companies of the Cayman Islands or such later time (being not later than the 90th day after registration by the Registrar of Companies of the Cayman Islands) as Merger Sub II and the Surviving Entity may agree and specify pursuant to the Cayman Act (the “**Second Merger Effective Time**”).

(d) *Effect of the Mergers.* The effect of the Mergers shall be as provided in this Agreement, the Plan of First Merger, the Plan of Second Merger and the applicable provisions of the Cayman Act. Without limiting the generality of the foregoing, and subject thereto, (a) at the First Merger Effective Time, all the property, rights, privileges, agreements, powers and franchises, debts, liabilities, duties and obligations of Merger Sub I and SPAC shall become the property, rights, privileges, agreements, powers and franchises, debts, liabilities, duties and obligations of the Surviving Entity, which shall include the assumption by the Surviving Entity of any and all agreements, covenants, duties and obligations of Merger Sub I and SPAC set forth in this Agreement to be performed after the First Merger Effective Time, and (b) at the Second Merger Effective Time, all the property, rights, privileges, agreements, powers and franchises, debts, liabilities, duties and obligations of the Surviving Entity and Merger Sub II shall become the property, rights, privileges, agreements, powers and franchises, debts, liabilities, duties and obligations of the Surviving Company, which shall include the assumption by the Surviving Company of any and all agreements, covenants, duties and obligations of the Surviving Entity and Merger Sub II set forth in this Agreement to be performed after the Second Merger Effective Time.

(e) *Organizational Documents of the Surviving Entity and the Surviving Company.* At the First Merger Effective Time, the memorandum and articles of association of Merger Sub I, as in effect immediately prior to the First Merger Effective Time and in the form attached hereto as Exhibit D-1 (the “**Amended Articles of the Surviving Entity**”), shall be the memorandum and articles of association of the Surviving Entity. At the Second Merger Effective Time, the memorandum and articles of association of Merger Sub II, as in effect immediately prior to the Second Merger Effective Time and in the form attached hereto as Exhibit D-2 (the “**Amended Articles of the Surviving Company**”), shall be the memorandum and articles of association of the Surviving Company, until, thereafter changed or amended as provided therein or by applicable Law.

(f) *Directors and Officers of the Surviving Entity and the Surviving Company.* At the First Merger Effective Time, the directors and officers of SPAC immediately prior to the First Merger Effective Time shall resign and the directors and officers of Merger Sub I immediately prior to the First Merger Effective Time shall be the directors and officers of the Surviving Entity, each to hold office in accordance with the Organizational Documents of the Surviving Entity. At the Second Merger Effective Time, the directors and officers of Merger Sub II immediately prior to the Second Merger Effective Time shall be the directors and officers of the Surviving Company, each to hold office in accordance with the Organizational Documents of the Surviving Company.

(g) *Directors and Officers of the Company.* At the First Merger Effective Time, (i) Mr. Bo Tan (or in the event such Person is unable or unwilling to serve as a director, another individual who was a director of SPAC prior to the Closing designated by SPAC in writing at least two (2) Business Days before the First Merger Effective Time, subject to such Person passing customary background checks by the Company) (the “*SPAC Director*”) and (ii) one additional director as nominated by the Company shall be appointed as directors on the board of directors of the Company, in addition to the then existing directors of the Company (the “*Company Directors*”), effective as of the First Merger Effective Time, and each of such newly appointed directors shall hold office in accordance with the Amended Company Charter until he is removed or resign in accordance with the Amended Company Charter or until his successor is duly elected or appointed and qualified. Ms. Rui Lin and Mr. Zhi Chen shall resign as directors of the Company, effective immediately prior to the First Merger Effective Time.

(h) *Effect of the Mergers on Issued Securities of SPAC, Merger Sub I and Merger Sub II.* On the terms and subject to the conditions set forth herein, by virtue of the Mergers and without any further action on the part of any Party or any other Person, the following shall occur:

(i) **SPAC Units.** Immediately prior to the First Merger Effective Time, each SPAC Unit issued and outstanding immediately prior to the First Merger Effective Time shall be automatically detached and the holder thereof shall be deemed to hold one SPAC Class A Ordinary Share and one-half of a SPAC Warrant in accordance with the terms of the applicable SPAC Unit (the “*Unit Separation*”), provided that no fractional SPAC Warrants will be issued in connection with the Unit Separation such that if a holder of SPAC Units would be entitled to receive a fractional SPAC Warrant upon the Unit Separation, the number of SPAC Warrants to be issued to such holder upon the Unit Separation shall be rounded down to the nearest whole number of SPAC Warrants. The underlying SPAC Securities held or deemed to be held following the Unit Separation shall be converted in accordance with the applicable terms of this Section 2.2(h).

(ii) **SPAC Ordinary Shares.** Immediately following the separation of each SPAC Unit in accordance with Section 2.2(h)(i) and the Company Capital Restructuring,

(1) each SPAC Class A Ordinary Share (which, for the avoidance of doubt, includes (x) the SPAC Class A Ordinary Shares held by the public shareholders of SPAC as a result of the Unit Separation and (y) the SPAC Class A Ordinary Shares issued pursuant to the Forward Purchase Subscriptions) issued and outstanding immediately prior to the First Merger Effective Time (other than any SPAC Shares referred to in Section 2.2(h)(iv) and Section 2.2(h)(ii)(3), Redeeming SPAC Shares and Dissenting SPAC Shares) shall automatically be cancelled and cease to exist in exchange for the right to receive, upon delivery of the applicable Letter of Transmittal (if any) in accordance with Section 2.4, such fraction of a newly issued Company Ordinary Share that is equal to the SPAC Class A Exchange Ratio, without interest, subject to rounding pursuant to Section 2.4(e);

(2) (a) an aggregate of 1,446,525 SPAC Class B Ordinary Shares held by Sponsor will be surrendered for nil consideration; and (b) after such surrender, each of the remaining SPAC Class B Ordinary Shares issued and outstanding immediately prior to the First Merger Effective Time and held by the SPAC Insiders (and the SPAC Class A Ordinary Shares into which such SPAC Class B Ordinary Shares are convertible or converted) shall automatically be cancelled and cease to exist in exchange for the right to receive, upon delivery of the applicable Letter of Transmittal (if any) in accordance with Section 2.4, one newly issued Company Ordinary Share; and

(3) each SPAC Class B Ordinary Share held by a Forward Purchase Investor and its permitted transferees (and the SPAC Class A Ordinary Shares into which such SPAC Class B Ordinary Shares are convertible or converted) issued and outstanding immediately prior to the First Merger Effective Time shall automatically be cancelled and cease to exist in exchange for the right to receive, upon delivery of the applicable Letter of Transmittal (if any) in accordance with Section 2.4, (a) such fraction of a newly issued Company Ordinary Share that is equal to the SPAC Class A Exchange Ratio, without interest, subject to rounding pursuant to Section 2.4(e), if and only if such Forward Purchase Investor has fully delivered its portion of the Forward Purchase Investment Amount as required under the applicable Forward Purchase Agreement and, failing that, (b) one newly issued Company Ordinary Share;



As of the First Merger Effective Time, each SPAC Shareholder shall cease to have any other rights in and to such SPAC Shares, except as expressly provided in Section 2.2(h)(v) and Section 2.2(h)(vi).

**(iii) Exchange of SPAC Warrants.** Each SPAC Warrant (which, for the avoidance of doubt, includes (1) the SPAC Warrants held by public SPAC warrant holders as a result of the Unit Separation, (2) the SPAC Warrants held by the Sponsor, and (3) the SPAC Warrants held by the Forward Purchase Investors) outstanding immediately prior to the First Merger Effective Time shall cease to be a warrant with respect to SPAC Ordinary Shares and be assumed by the Company and converted into a warrant to purchase one Company Ordinary Share (each, a “*Company Warrant*”). Each Company Warrant shall continue to have and be subject to substantially the same terms and conditions as were applicable to such SPAC Warrant immediately prior to the First Merger Effective Time (including any repurchase rights and cashless exercise provisions) in accordance with the provisions of the Warrant Assignment Agreement.

**(iv) SPAC Treasury Shares.** Notwithstanding Section 2.2(h)(ii) above or any other provision of this Agreement to the contrary, if there are any SPAC Shares that are owned by SPAC as treasury shares or any SPAC Shares owned by any direct or indirect Subsidiary of SPAC immediately prior to the First Merger Effective Time, such SPAC Shares shall be cancelled and shall cease to exist without any conversion thereof or payment or other consideration therefor.

**(v) Redeeming SPAC Shares.** Each Redeeming SPAC Share issued and outstanding immediately prior to the First Merger Effective Time shall be cancelled and cease to exist and shall thereafter represent only the right to be paid a pro rata share of the SPAC Shareholder Redemption Amount in accordance with SPAC’s Charter.

**(vi) Dissenting SPAC Shares.** Each Dissenting SPAC Share issued and outstanding immediately prior to the First Merger Effective Time held by a Dissenting SPAC Shareholder shall be cancelled and cease to exist in accordance with Section 2.6(a) and shall thereafter represent only the right to be paid the fair value of such Dissenting SPAC Share and such other rights pursuant to Section 238 of the Cayman Act.

**(vii) Merger Sub Shares.** At the First Merger Effective Time, the Merger Sub I Share issued and outstanding immediately prior to the First Merger Effective Time shall automatically convert into one ordinary share, par value \$0.0001 per share, of the Surviving Entity. The ordinary share of the Surviving Entity shall have the same rights, powers and privileges as the shares so converted and shall constitute the only issued and outstanding share capital of the Surviving Entity. At the Second Merger Effective Time, each share of the Surviving Entity that is issued and outstanding immediately prior to the Second Merger Effective Time will be automatically cancelled and extinguished without any conversion thereof or payment therefor. The Merger Sub II Share that is issued and outstanding immediately prior to the Second Merger Effective Time shall remain outstanding and shall not be affected by the Second Merger.

### Section 2.3 Closing.

**(a)** On the terms and subject to the conditions of this Agreement, the consummation of the Mergers (the “*Closing*”, and the day on which the Closing occurs, the “*Closing Date*”) shall take place remotely by conference call and exchange of documents and signatures in accordance with Section 11.9 on the date that is three (3) Business Days after the first date on which all conditions set forth in Article IX that are required hereunder to be satisfied on or prior to the Closing shall have been satisfied or waived (other than those conditions that by their terms are to be satisfied at the Closing, but subject to the satisfaction or waiver thereof), unless extended in accordance with Section 2.6(c) or at such other time or in such other manner as shall be agreed upon by SPAC and the Company in writing; **provided** that if the First Merger and the Second Merger are not consummated on the same day, references to the Closing and the Closing Date shall be construed to mean the consummation of the First Merger and the date of the First Merger Effective Time, respectively, and each party hereto shall take all actions within its power as may be necessary or appropriate such that the Second Merger is consummated as promptly as reasonably practicable after the Closing.

**(b)** Prior to or on the Closing Date,

**(i)** the Company shall deliver or cause to be delivered to SPAC, a certificate signed by an authorized director or officer of the Company, dated as of the Closing Date, certifying that the conditions specified in Section 9.2 have been fulfilled;

(ii) SPAC shall deliver or cause to be delivered to the Company a certificate signed by an authorized director or officer of SPAC, dated as of the Closing Date, certifying that the conditions specified in Section 9.3 have been fulfilled.

(iii) the Company shall deliver or cause to be delivered to SPAC, evidence of the appointment of the SPAC Director as a director on the board of directors of the Company in accordance with Section 2.2(g), effective as of the First Merger Effective Time;

(iv) the SPAC shall deliver or cause to be delivered to the Company, evidence of the resignation or removal of all the directors of SPAC as a director on the board of directors of the Surviving Entity in accordance with Section 2.2(g), effective as of the First Merger Effective Time;

(v) the SPAC shall deliver or cause each SPAC Insider to deliver to the Company, a deed of adherence duly executed by such SPAC Insider in substantially the form of Annex I attached to the Shareholder Support Agreement, effective on or prior to the First Merger Effective Time;

(vi) the Company shall deliver or cause each Company Shareholder (if not already a party to the Shareholders Support Agreement) to deliver to SPAC, a deed of adherence duly executed by such Company Shareholder in substantially the form of Annex I attached to the Shareholder Support Agreement, effective on or prior to the First Merger Effective Time;

(vii) the Company and SPAC (or the Surviving Entity following the First Merger and the Surviving Company following the Second Merger), shall:

(1) cause any documents, opinions and notices required to be delivered to the Trustee pursuant to the Trust Agreement to be so delivered;

(2) pay, or cause the Trustee to pay at the direction and on behalf of SPAC (or the Surviving Entity following the First Merger and the Surviving Company following the Second Merger), by wire transfer of immediately available funds from the Trust Account (A) as and when due all amounts payable on account of the SPAC Shareholder Redemption Amount to former SPAC Shareholders pursuant to their exercise of the SPAC Shareholder Redemption Right, (B) all accrued and unpaid Company Transaction Expenses and, subject to Section 11.6, all accrued and unpaid SPAC Transaction Expenses, each as set forth on a written statement to be delivered to the Surviving Company by or on behalf of the Company and SPAC, respectively, not less than two (2) Business Days prior to the Closing Date, which shall include the respective amounts and wire transfer instructions for the payment thereof, and (C) immediately thereafter, all remaining amounts then available in the Trust Account (if any) (the “*Remaining Trust Fund Proceeds*”) to a bank account designated by the Company for its immediate use, subject to this Agreement (including, for the avoidance of doubt, Section 8.7) and the Trust Agreement; and

(3) thereafter, the Trust Account shall terminate, except as otherwise provided in the Trust Agreement.

#### **Section 2.4 Cancellation of SPAC Equity Securities and Disbursement of Merger Consideration.**

(a) Prior to the First Merger Effective Time, the Company shall appoint an exchange agent reasonably acceptable to the Company and SPAC as exchange agent (for the avoidance of doubt, Continental Stock Transfer & Trust Company shall be deemed to be reasonably acceptable to SPAC) (in such capacity, the “*Exchange Agent*”), for the purpose of exchanging SPAC Ordinary Shares for the Merger Consideration in accordance with the Plan of First Merger and this Agreement, and paying the Merger Consideration to the SPAC Shareholders. At or before the First Merger Effective Time, the Company shall deposit, or cause to be deposited, with the Exchange Agent the Merger Consideration.

(b) If the Exchange Agent requires that, as a condition to receive the Merger Consideration, any SPAC Shareholder deliver a letter of transmittal to the Exchange Agent, then at or as promptly as practicable following the First Merger Effective Time, the Company shall send, or shall cause the Exchange Agent to send, to each SPAC Shareholder a letter of transmittal (which shall specify that the delivery shall be effected, and the risk of loss and title shall pass, only upon proper transfer of each share to the Exchange Agent, and which letter of transmittal will be in customary form and have such other provisions as SPAC and the

Company may reasonably specify) for use in such exchange (each, a “*Letter of Transmittal*”). Notwithstanding anything to the contrary contained herein, any obligation on the Company under this Agreement to issue Company Ordinary Shares to SPAC Shareholders entitled to receive Company Ordinary Shares may be satisfied by the Company issuing such Company Ordinary Shares, and shall be deemed to have been satisfied upon issuance of such Company Ordinary Shares, (i) to the DTC or to such other clearing service or issuer of depositary receipts (or their nominees, in either case) as may be necessary or expedient, and each SPAC Shareholder shall hold such Company Ordinary Shares in book-entry form or through a holding of depositary receipts and the DTC or its nominee or the relevant clearing service or issuer of depositary receipts (or their nominees, as the case may be), will be the holder of record of such Company Ordinary Shares or (ii) directly to each SPAC Shareholder by entering such SPAC Shareholder on the register of members maintained by the Company (or its share registrar) for the Company Ordinary Shares.

(c) Each SPAC Shareholder shall be entitled to receive its portion of the Merger Consideration, pursuant to Section 2.2(h)(ii) (excluding any SPAC Shares referred to in Section 2.2(h)(iv), Redeeming SPAC Shares and any Dissenting SPAC Shares) upon the receipt of an “agent’s message” by the Exchange Agent (or such other evidence, if any, of transfer as the Exchange Agent may reasonably request), together with a duly completed and validly executed Letter of Transmittal (if required by the Exchange Agent in accordance with Section 2.4(b)) and such other documents as may reasonably be requested by the Exchange Agent. No interest shall be paid or accrued upon the transfer of any share.

(d) Promptly following the date that is one (1) year after the First Merger Effective Time, the Company shall instruct the Exchange Agent to deliver to the Company all documents in its possession relating to the transactions contemplated hereby, and the Exchange Agent’s duties shall terminate. Thereafter, any portion of the Merger Consideration that remains unclaimed shall be returned to the Company and the unclaimed Company Ordinary Shares comprising the Merger Consideration shall be held by the Company as treasury shares, and any Person that was a holder of SPAC Shares (other than any SPAC Shares referred to in Section 2.2(h)(iv), Redeeming SPAC Shares and Dissenting SPAC Shares) as of immediately prior to the First Merger Effective Time that has not claimed their applicable portion of the Merger Consideration in accordance with this Section 2.4 prior to the date that is one (1) year after the First Merger Effective Time, may (subject to applicable abandoned property, escheat and similar Laws) claim from the Company, and the Company shall promptly transfer and deliver, such applicable portion of the Merger Consideration without any interest thereupon. None of SPAC, the Company, the Merger Subs, the Surviving Entity, the Surviving Company or the Exchange Agent shall be liable to any Person in respect of any of the Merger Consideration delivered to a public official pursuant to and in accordance with any applicable abandoned property, escheat or similar Laws. If any such Merger Consideration shall not have been claimed immediately prior to such date on which any amounts payable pursuant to this Article II would otherwise escheat to or become the property of any Governmental Authority, any such amount shall be cancelled by the Company.

(e) Notwithstanding anything to the contrary contained herein, no fraction of a Company Ordinary Share will be issued by virtue of the Mergers or the other Transactions under this Section 2.4, and each Person who would otherwise be entitled to a fraction of a Company Ordinary Share (after aggregating all fractional Company Ordinary Shares that otherwise would be received by such holder) shall instead have the number of Company Ordinary Shares issued to such Person rounded down in the aggregate to the nearest whole Company Ordinary Share.

**Section 2.5 Further Assurances.** If, at any time after the First Merger Effective Time, any further action is necessary, proper or advisable to carry out the purposes of this Agreement, the Surviving Entity, the Surviving Company, Merger Sub II and the Company (or their respective designees) shall take all such actions as are necessary, proper or advisable under applicable Laws, so long as such action is consistent with and for the purposes of implementing the provisions of this Agreement.

**Section 2.6 Dissenter’s Rights.**

(a) Subject to Section 2.2(c)(ii) but notwithstanding any other provision of this Agreement to the contrary and to the extent available under the Cayman Act, SPAC Shares that are issued and outstanding immediately prior to the First Merger Effective Time and that are held by SPAC Shareholders who shall have validly exercised their dissenters’ rights for such SPAC Shares in accordance with Section 238 of the Cayman Act and otherwise complied with all of the provisions of the Cayman Act relevant to the exercise and

enforcement of dissenters' rights (the "**Dissenting SPAC Shares**", and the holders of such Dissenting SPAC Shares being the "**Dissenting SPAC Shareholders**") shall be cancelled and cease to exist at the First Merger Effective Time and the Dissenting SPAC Shareholders shall not be entitled to receive the applicable Merger Consideration and shall instead be entitled to receive only the payment of the fair value of such Dissenting SPAC Shares held by them as determined in accordance with the provisions of Section 238 of the Cayman Act. For the avoidance of doubt, the SPAC Shares owned by any SPAC Shareholder who fails to exercise or who effectively withdraws or otherwise loses his, her or its dissenters' rights pursuant to Section 238 of the Cayman Act shall not be Dissenting SPAC Shares and shall thereupon be cancelled and cease to exist at the First Merger Effective Time, in exchange for the right to receive the applicable Merger Consideration, without any interest thereon in accordance with Section 2.2(h)(ii).

(b) Prior to the Closing, SPAC shall give the Company (i) prompt written notice of any demands for dissenters' rights received by SPAC from SPAC Shareholders and any withdrawals of such demands and (ii) the opportunity to direct all negotiations and proceedings with respect to any such notice or demand for dissenters' rights under the Cayman Act. SPAC shall not, except with the prior written consent of the Company, make any offers or payment or otherwise agree or commit to any payment or other consideration with respect to any exercise by a SPAC Shareholder of its rights to dissent from the First Merger or any demands for appraisal or offer or agree or commit to settle or settle any such demands or approve any withdrawal of any such dissenter rights or demands.

(c) If any SPAC Shareholder gives to SPAC, before the SPAC Shareholders' Approval is obtained at the SPAC Shareholders' Meeting, written objection to the First Merger (each, a "**Written Objection**") in accordance with Section 238(2) of the Cayman Act:

(i) SPAC shall, in accordance with Section 238(4) of the Cayman Act, promptly give written notice of the authorization of the First Merger (the "**Authorization Notice**") to each such SPAC Shareholder who has made a Written Objection, and

(ii) unless SPAC and the Company elect by agreement in writing to waive this Section 2.6(c)(ii), no party shall be obligated to commence the Closing, and the Plan of First Merger shall not be filed with the Registrar of Companies of the Cayman Islands, until at least twenty (20) days shall have elapsed since the date on which the Authorization Notice is given (being the period allowed for written notice of an election to dissent under Section 238(5) of the Cayman Act, as referred to in Section 239(1) of the Cayman Act), but in any event subject to the satisfaction or waiver of all of the conditions set forth in Section 9.1, Section 9.2 and Section 9.3.

**Section 2.7 Withholding.** Each of the parties hereto and any other applicable withholding agent (and their respective Affiliates and Representatives) shall be entitled to deduct and withhold from any amount otherwise payable pursuant to this Agreement such amount as it is required to deduct and withhold with respect to the making of such payment under the Code, or any provision of state, local or non-U.S. Tax Law. The parties hereto shall use commercially reasonable efforts to notify the Person in respect of whom such deduction or withholding is expected to be made prior to making any such deduction or withholding, which notice shall be in writing and include the amount of and basis for such deduction or withholding. The parties hereto shall use commercially reasonable efforts to cooperate and reduce or eliminate any such deduction or withholding to the extent permitted by applicable Law. To the extent that amounts are so deducted or withheld, and paid over to the appropriate Governmental Authority, such deducted or withheld amounts shall be treated for all purposes of this Agreement as having been paid to the Person in respect of which such deduction or withholding was made.

## ARTICLE III

### REPRESENTATIONS AND WARRANTIES OF THE COMPANY

Except (a) as set forth in the disclosure letter delivered to SPAC by the Company on the date of this Agreement (the "**Company Disclosure Letter**"), or (b) as otherwise explicitly contemplated by this Agreement, the Company represents and warrants to SPAC as of the date of this Agreement as follows:

**Section 3.1 Organization, Good Standing and Qualification.** The Company is an exempted company duly incorporated, validly existing and in good standing under the Laws of the Cayman Islands and has

requisite corporate power and authority to own and operate its properties and assets, to carry on its business as presently conducted and contemplated to be conducted. The Company is duly licensed or qualified and in good standing as a foreign or extra-provincial corporation (or other entity, if applicable) in each jurisdiction in which its ownership of property or the character of its activities is such as to require it to be so licensed or qualified or in good standing, as applicable, except where the failure to be so licensed or qualified or in good standing would not be material to the Group taken as a whole. Prior to the execution of this Agreement, true and accurate copies of the Company Charter, the Shareholders Agreement and the Organizational Documents of the Group Companies, each as in effect as of the date of this Agreement, have been Made Available by or on behalf of the Company to SPAC, such governing documents are in full force and effect, and the Company and each of the Group Companies is not in default of any term or provision of such governing documents in any material respect. The Company is not insolvent, bankrupt or unable to pay its debts as and when they fall due.

**Section 3.2 Subsidiaries.** A complete list, as of the date of this Agreement, of each Subsidiary of the Company and its jurisdiction of incorporation, formation or organization, outstanding Equity Securities, and holders of Equity Securities, as applicable, is set forth on Section 3.2(a) of the Company Disclosure Letter. Except as set forth on Section 3.2(a) and Section 3.2(b) of the Company Disclosure Letter, the Company does not directly or indirectly own any equity or similar interests in, or any interest convertible into or exchangeable or exercisable for any equity or similar interest in, any other corporation, company, partnership, joint venture or business association or other entity. Each Subsidiary of the Company has been duly organized and is validly existing and in good standing under the Laws of its jurisdiction of incorporation and has requisite corporate power and authority to own and operate its properties and assets, to carry on its business as presently conducted and contemplated to be conducted. Each Subsidiary of the Company is not insolvent, bankrupt or unable to pay its debts as and when they fall due. Each Subsidiary of the Company is duly licensed or qualified and in good standing (to the extent such concept is applicable in the Group Company's jurisdiction of formation) as a foreign or extra-provincial corporation (or other entity, if applicable) in each jurisdiction in which its ownership of property or the character of its activities is such as to require it to be so licensed or qualified or in good standing (to the extent such concept is applicable in the Group Company's jurisdiction of formation), as applicable, except where the failure to be so licensed or qualified or in good standing would not be material to the Group taken as a whole.

**Section 3.3 Capitalization of the Company.**

(a) As of the date of this Agreement, the authorized share capital of the Company is \$50,000 divided into 10,000,000,000 shares of \$0.000005 par value each, comprised of (x) 9,850,000,000 Ordinary Shares, of which (1) 246,736,533 Ordinary Shares are issued and outstanding as of the date of this Agreement and (2) 26,626,329 Ordinary Shares are subject to issuance upon the vesting of Company Options outstanding as of the date of this Agreement, (y) 50,000,000 Company Series A Preferred Shares, of which 21,548,589 Company Series A Preferred Shares are issued and outstanding as of the date of this Agreement, and (z) 100,000,000 Company Series B Preferred Shares, of which 65,414,858 Company Series B Preferred Shares are issued and outstanding as of the date of this Agreement). As of the date of this Agreement, the aggregate number of Fully-Diluted Company Shares is 333,699,980. Set forth in Section 3.3(a) of the Company Disclosure Letter is a true and correct list of each holder of Company Shares and the number of Company Shares held by each such holder as of the date hereof. There are no other shares of the Company issued or outstanding as of the date of this Agreement. All of the issued and outstanding Company Shares (w) have been duly authorized and validly issued and allotted and are fully paid and non-assessable; (x) have been offered, sold and issued by the Company in compliance with applicable Law, including the Cayman Act, U.S. federal and state securities Laws, and all requirements set forth in (1) the Company Charter and the Shareholders Agreement and (2) any other applicable Contracts governing the issuance or allotment of such securities to which the Company is a party or otherwise bound; and (y) are not subject to, nor have they been issued in violation of, any Encumbrance, purchase option, call option, pre-emptive right, subscription right or any similar right under any provision of any applicable Law, the Company Charter, and the Shareholders Agreement or any other Contract, in any such case to which the Company is a party or otherwise bound.

(b) The Company has provided to SPAC, prior to the date of this Agreement, a true and correct list of each current or former employee, consultant, officer or director of the Company or any other Group Company who, as of the date of this Agreement, holds Company Options, including the number of Ordinary Shares

subject thereto, the vesting schedule and expiration date thereof. All Company Options outstanding as of the date of this Agreement are evidenced by award agreements in substantially the forms previously Made Available to SPAC.

(c) Except as otherwise set forth in this Section 3.3 or on Section 3.3(c) of the Company Disclosure Letter or as contemplated by this Agreement or the other Transaction Documents, there are no outstanding subscriptions, options, warrants, rights or other securities (including debt securities) of the Company exercisable or exchangeable for Company Shares, any other commitments, calls, conversion rights, rights of exchange or privilege (whether pre-emptive, contractual or by matter of Law), plans or other agreements of any character providing for the issuance of additional shares, the surrender or forfeiture of outstanding shares, the sale of treasury shares or the issuance or sale by the Company of other Equity Securities of the Company, or for the repurchase or redemption by the Company of shares or other Equity Securities of the Company or the value of which is determined by reference to shares or other Equity Securities of the Company, and there are no voting trusts, proxies or agreements of any kind which may obligate the Company to issue, purchase, register for sale, redeem or otherwise acquire any Company Shares or other Equity Securities of the Company.

#### **Section 3.4 Capitalization of Subsidiaries.**

(a) The outstanding share capital or other Equity Securities of each of the Company's Subsidiaries (i) have been duly authorized and validly issued and allotted, and are, to the extent applicable and where required by applicable Law, fully paid and non-assessable; (ii) have been offered, sold, issued and allotted in compliance with applicable Law, including federal and state securities Laws, and all requirements set forth in (1) the Organizational Documents of each such Subsidiary, and (2) any other applicable Contracts governing the issuance or allotment of such securities to which such Subsidiary is a party or otherwise bound; and (iii) are not subject to, nor have they been issued in violation of, any purchase option, call option, right of first refusal, pre-emptive right, subscription right or any similar right under any provision of any applicable Law, the Organizational Documents of each such Subsidiary or any other Contract, in any such case to which each such Subsidiary is a party or otherwise bound.

(b) Except as contemplated by this Agreement or the other Transaction Documents, the Company owns, directly or indirectly through its Subsidiaries, of record and beneficially all the issued and outstanding Equity Securities of such Subsidiaries free and clear of any Encumbrances other than Permitted Encumbrances.

(c) Except as contemplated by this Agreement or the other Transaction Documents, there are no outstanding subscriptions, options, warrants, rights or other securities (including debt securities) of any such Subsidiary exercisable or exchangeable for any Equity Securities of such Subsidiary, any other commitments, calls, conversion rights, rights of exchange or privilege (whether pre-emptive, contractual or by matter of Law), plans or other agreements of any character providing for the issuance by any such Subsidiary of additional shares, the sale of treasury shares or the issuance or sale by such Subsidiary of other Equity Securities of such Subsidiary, or for the repurchase or redemption by such Subsidiary of shares or other Equity Securities of such Subsidiary the value of which is determined by reference to shares or other Equity Securities of such Subsidiary, and there are no voting trusts, proxies or agreements of any kind which may obligate any such Subsidiary to issue, purchase, register for sale, redeem or otherwise acquire any of its Equity Securities.

#### **Section 3.5 Authorization.**

(a) The Company has all corporate power and authority to (i) enter into, execute and deliver this Agreement and each of the other Transaction Documents to which it is or will be a party, and (ii) consummate the transactions contemplated hereby and thereby (including the Transactions) and perform all of its obligations hereunder and thereunder. The execution and delivery of this Agreement and the other Transaction Documents to which the Company is a party and the consummation of the transactions contemplated hereby and thereby (including the Transactions) have been duly and validly authorized and approved by the Company Board and the Company Shareholders (including the Majority Preferred Holders, as defined in the Company Charter), and no other company or corporate proceeding on the part of the Company is necessary to authorize this Agreement and the other Transaction Documents to which the Company is a party and to consummate the transactions contemplated hereby and thereby (including the Transactions). This Agreement and the other

Transaction Documents to which the Company is a party have been duly and validly executed and delivered by the Company, and this Agreement and the other Transaction Documents to which the Company is a party constitute a legal, valid and binding obligation of the Company, enforceable against the Company in accordance with its terms, except (a) as limited by applicable bankruptcy, insolvency, reorganization, moratorium, and other applicable Laws now or hereafter in effect of general application affecting enforcement of creditors' rights generally, and (b) as limited by applicable Laws relating to the availability of specific performance, injunctive relief, or other equitable remedies (collectively, the "*Enforceability Exceptions*").

(b) On or prior to the date of this Agreement, the Company has obtained (i) approvals and consents of holders of Company Shares and other Equity Securities of the Company necessary in connection with execution by the Company of this Agreement and the other Transaction Documents to which the Company is a party and the consummation of the transactions contemplated hereby and thereby, including (A) Special Resolution (as defined in the Company Charter) of the Company Shareholders and (B) the prior written approval of the Majority Preferred Holders (as defined in the Company Charter), in each case pursuant to the terms and subject to the conditions of the Company Charter and applicable Law (the "*Company Shareholders' Approval*"), and (ii) approval by the Majority Lenders (as defined in the facility agreement dated March 16, 2022 entered into by, among others, YishengBio (Hong Kong) Holdings Limited (as the borrower) and R-Bridge Investment Three Pte. Ltd. (as the lender) (the "*Company Lender's Approval*"). On or prior to the date of this Agreement, the Company Board has duly adopted resolutions (i) determining that this Agreement and the other Transaction Documents to which the Company is a party and the transactions contemplated hereby and thereby (including the Transactions) are advisable and fair to, and in the best interests of, the Company and its shareholders, as applicable, (ii) authorizing and approving the execution, delivery and performance by the Company of this Agreement and the other Transaction Documents to which the Company is a party and the transactions contemplated hereby and thereby (including the Transactions), and (iii) directing that this Agreement, the Transaction Documents and the Transactions be submitted to the Company Shareholders for approval and authorization at an extraordinary general meeting called for such purpose pursuant to the terms and conditions of this Agreement (including any adjournment or postponement thereof, the "*Company Shareholders' Meeting*").

**Section 3.6 Consents; No Conflicts.** Assuming the representations and warranties in Article IV and Article V are true and correct, except (a) for the registration or filing with the Registrar of Companies of the Cayman Islands, the SEC or applicable state blue sky or other securities laws filings with respect to the Transactions and (b) for such other filings, notifications, notices, submissions, applications or consents the failure of which to be obtained or made would not, individually or in the aggregate, have, or reasonably be expected to have, a material adverse effect on the ability of the Company to enter into and perform its obligations under this Agreement, all filings, notifications, notices, submissions, applications, or consents from or with any Governmental Authority or any other Person required in connection with the valid execution, delivery and performance of this Agreement and the other Transaction Documents, and the consummation of the Transactions, in each case on the part of the Company, have been or will be duly obtained or completed (as applicable) and are or will be in full force and effect. The execution, delivery and performance of this Agreement and the other Transaction Documents to which it is or will be a party by the Company does not, and the consummation by the Company of the transactions contemplated hereby and thereby will not, assuming the representations and warranties in Article IV and Article V are true and correct, and except for the matters referred to in clauses (a) through (b) of the immediately preceding sentence, (i) result in any violation of, be in conflict with, or constitute a default under, require any consent under, or give any Person rights of termination, amendment, acceleration (including acceleration of any obligation of any Group Company) or cancellation under, (A) any Governmental Order, (B) any provision of the Organizational Documents of any Group Company, each as currently in effect, (C) any applicable Law, (D) any Material Contract or (ii) result in the creation of any Encumbrance upon any of the properties or assets of any Group Company other than any restrictions under federal or state securities laws, this Agreement, the Company Charter and Permitted Encumbrances, except in the case of sub-clauses (A), (C), and (D) of clause (i) and clause (ii), as would not have a Company Material Adverse Effect.

**Section 3.7 Compliance with Laws; Consents; Permits.**

(a) Except as would not be or reasonably be expected to be material to the business of the Company and its Subsidiaries, taken as a whole, since April 1, 2020, (i) the Company and its Subsidiaries are, and have

been, in compliance with all applicable Laws; (ii) neither the Company nor any of its Subsidiaries is or has been subject to any actual, pending or, to the Knowledge of the Company, threatened Action with respect to a violation of any applicable Laws; and (iii) neither the Company nor any of its Subsidiaries, to the Knowledge of the Company, is or has been subject to any investigation by or for any Governmental Authority with respect to any violation of any applicable Laws.

(b) Since April 1, 2020, neither the Company nor any of its Subsidiaries has received any letter or other written communication from, and, to the Knowledge of the Company, there has not been any public notice of a type customary as a form of notification of such matters in the jurisdiction by, any Governmental Authority threatening in writing or providing notice of (i) the revocation or suspension of any Required Governmental Authorizations issued to the Company or any of its Subsidiaries or (ii) the need for compliance or remedial actions in respect of the activities carried out by the Company or any of its Subsidiaries, except where such revocation, suspension, compliance or remedial actions (or the failure of the Company or any of its Subsidiaries to undertake them) has not been and would not reasonably be expected to be material to the business of the Company and its Subsidiaries, taken as a whole.

(c) Neither the Company nor any of its Subsidiaries is engaged in any pending proceedings, demands, inquiries, or hearings or investigations, before any court, statutory or governmental body, department, board or agency relating to applicable Anti-Corruption Laws, Anti-Money Laundering Laws or Sanctions, and to the Knowledge of the Company, no such proceeding, demand, inquiry, investigation or hearing has been threatened in writing.

(d) None the Company, any of its Subsidiaries, any of their respective directors or officers, or to the Knowledge of the Company, employees, agents or any other Persons acting for or on behalf of the Company or any of its Subsidiaries has at any time since April 1, 2020: (i) made any bribe, influence payment, kickback, payoff, benefits or any other type of payment (whether tangible or intangible) that would be unlawful under any applicable anti-bribery or anti-corruption (governmental or commercial) laws (including, for the avoidance of doubt, any guiding, detailing or implementing regulations), including Laws that prohibit the corrupt payment, offer, promise or authorization of the payment or transfer of anything of value (including gifts or entertainment), directly or indirectly, to any Government Official, Governmental Authority or any other individual or commercial entity to obtain a business advantage, such as the Foreign Corrupt Practices Act of 1977, as amended, the U.K. Bribery Act 2010, or any other local or foreign anti-corruption or anti-bribery Law (collectively, “*Anti-Corruption Laws*”), as may be applicable; (ii) been in violation of any Anti-Corruption Law, offered, paid, promised to pay, or authorized any payment or transfer of anything of value, directly or indirectly, to any person for the purpose of (A) influencing any act or decision of any Government Official in his official capacity, (B) inducing a Government Official to do or omit to do any act in relation to his lawful duty, (C) securing any improper advantage, (D) inducing a Government Official to influence or affect any act, decision or omission of any Governmental Authority, or (E) assisting the Company or any of its Subsidiaries, or any agent or any other Person acting for or on behalf of the Company or any of its Subsidiaries, in obtaining or retaining business for or with, or in directing business to, any Person; or (iii) accepted or received any contributions, payments, gifts, or expenditures that would be unlawful under any Anti-Corruption Law.

(e) Neither the Company, any of its Subsidiaries, any of their respective directors or officers, nor to the Knowledge of the Company, employees, agents acting for or on behalf of the Company or any of its Subsidiaries, has at any time since April 1, 2020 been found by a Governmental Authority to have violated any Anti-Corruption Laws, Anti-Money Laundering Laws or Sanctions, or is subject to any indictment or any government investigation with respect to any Anti-Corruption Laws, Anti-Money Laundering Laws or Sanctions.

(f) Neither the Company, any of its Subsidiaries, any of their respective directors or officers, nor to the Knowledge of the Company, employees, agent or any other Person acting for or on behalf of the Company or any of its Subsidiaries, is a Prohibited Person, and no Prohibited Person has at any time since April 1, 2020 been given an offer to become an employee, officer, consultant or director of the Company or any of its Subsidiaries. None of the Company nor any of its Subsidiaries has at any time since April 1, 2020 conducted or agreed to conduct any business, or entered into or agreed to enter into any transaction with a Prohibited Person or otherwise violated Sanctions.



(g) Each of the Group Companies has all material approvals, authorizations, clearances, licenses, registrations, permits or certificates of a Governmental Authority (the “*Material Permits*”) that are required to own, lease or operate its properties and assets and to conduct its business as currently conducted in all material respects, and such Material Permits are in effect and have been complied with in all material respects. To the Knowledge of the Company, neither the Company nor any of its Subsidiaries has received any notice that any Governmental Authority that has issued any Material Permit intends to suspend, cancel, terminate, or not renew any such Material Permit, except to the extent such Material Permit may be amended, replaced, or reissued as a result of and as necessary to reflect the transactions contemplated hereby or may be terminated in the ordinary and usual course of a reissuance or replacement process.

### **Section 3.8 Tax Matters.**

(a) All income and other material Tax Returns required to be filed by or with respect to each Group Company have been filed within the requisite period (taking into account any valid extensions properly obtained) and such Tax Returns are true, correct, and complete in all material respects. All income and other material Taxes due and payable by each Group Company have been or will be paid in a timely fashion. Each Group Company has withheld and paid over to the appropriate Governmental Authority all material Taxes that it is required to withhold from amounts paid or owing to any employee, independent contractor, member, equityholder, creditor, or other Person.

(b) No material deficiencies for any Taxes that are currently outstanding with respect to any Tax Returns of a Group Company have been asserted in writing by any Governmental Authority. No written notice of any action, audit, assessment, or other proceeding, in each case that is currently pending, with respect to any Tax Returns or any Taxes of a Group Company has been received from any Governmental Authority. No dispute or assessment relating to such Tax Returns or such Taxes with any Governmental Authority is currently outstanding. No Group Company has consented to any extension or waiver of the time within which any Tax may be assessed or collected by a Governmental Authority, which extension or waiver remains in force.

(c) No Group Company has any material liability for unpaid Taxes which has not been accrued or reserved on such Group Company’s most recent financial statements, whether asserted or unasserted, contingent, or otherwise, and no Group Company has incurred any material liability of Taxes outside the Ordinary Course since the date of such financial statements.

(d) No Group Company is a Tax resident of any jurisdiction other than its jurisdiction of incorporation. No written claim that is currently outstanding has been made by a Governmental Authority in a jurisdiction where a Group Company does not file Tax Returns that such Group Company is or may be subject to taxation by that jurisdiction.

(e) There are no liens for Taxes (other than Permitted Encumbrances) upon the assets of any Group Company.

(f) No Group Company has been a member of an affiliated, consolidated, or similar Tax group (other than another Group Company) or otherwise has any liability for the Taxes of any other Person (other than another Group Company) under Treasury Regulations Section 1.1502-6 or any similar provision of state, local, or non-U.S. Law, as a transferee or successor, or by Contract (including any Tax sharing, allocation, or similar agreement or arrangement but excluding any commercial Contract entered into in the Ordinary Course and not primarily relating to Taxes).

(g) Each Group Company has complied in all material respects with all applicable transfer pricing Laws.

(h) Each Group Company is in compliance in all material respects with all terms and conditions of any Tax incentives, exemption, holiday, or other Tax reduction agreement or order of a Governmental Authority applicable to a Group Company, and the consummation of the Transactions will not have any material adverse effect on the continued validity and effectiveness of any such Tax incentives, exemption, holiday, or other Tax reduction agreement or order.

(i) Each Group Company is registered for value added and similar Taxes in each jurisdiction such Group Company is required to be so registered. Each Group Company has complied in all material respects with all applicable value added and similar Tax Laws.

(j) No Group Company has been a party to a transaction that is or is substantially similar to a “listed transaction” as defined in Treasury Regulations Section 1.6011-4(b)(2) or any transaction requiring disclosure under analogous provisions of state, local, or non-U.S. Law.

(k) No Group Company has a permanent establishment (within the meaning of an applicable Tax treaty) or otherwise has an office or fixed place of business in a country other than the country in which it is organized.

(l) The Company does not expect to be in the taxable year that includes the Closing Date, a PFIC.

(m) The Company reasonably believes that (i) Public Notice 7 shall not apply with respect to the Company Capital Restructuring, the Mergers and the transactions contemplated by this Agreement and (ii) none of the Company, SPAC, the Merger Subs, the Surviving Entity or the Surviving Company shall have any obligation for Public Notice 7 Taxes as a result thereof.

### **Section 3.9 Financial Statements.**

(a) The Company has Made Available to SPAC true and complete copies of the audited consolidated balance sheet of the Company and its Subsidiaries as of March 31, 2021 and March 31, 2022, and the related audited consolidated statements of income and profit and loss, and cash flows, for the fiscal years then ended (the “*Audited Financial Statements*”), together with the auditor’s reports thereon. The Audited Financial Statements (i) were prepared in accordance with the books and records of the Company and its Subsidiaries, (ii) fairly present, in all material respects, the financial condition and the results of operations and cash flow of the Company and its Subsidiaries on a consolidated basis as of the dates indicated therein and for the periods indicated therein, (iii) were prepared in accordance with GAAP applied on a consistent basis throughout the periods involved (except as may be indicated in the notes thereto), and (iv) when delivered by the Company for inclusion in the Proxy/Registration Statement for filing with the SEC, will comply in all material respects with the applicable accounting requirements (including the standards of the U.S. Public Company Accounting Oversight Board) and with the rules and regulations of the SEC, the Exchange Act and the Securities Act applicable to a registrant, in effect as of the respective dates thereof (including, to the extent applicable to the company, Regulation S-X).

(b) The Company maintains a system of internal accounting controls which is reasonably sufficient to provide reasonable assurance that (i) transactions are executed in accordance with management’s general or specific authorizations, (ii) transactions are recorded as necessary to permit preparation of financial statements in conformity with GAAP and to maintain asset accountability, (iii) access to assets is permitted only in accordance with management’s general or specific authorization and (iv) the recorded accountability for assets is compared with the existing assets at reasonable intervals and appropriate action is taken with respect to any differences.

(c) None of the Company’s directors has been made aware of (i) any fraud that involves the Company’s management who have a role in the preparation of financial statements or the internal accounting controls utilized by the Company or (ii) any allegation, assertion or claim that the Company has engaged in any material questionable accounting or auditing practices which violate applicable Law; in each case that has not been subsequently remediated as of the date hereof. No attorney representing the Company, whether or not employed by the Company, has reported a material violation of securities Laws, breach of fiduciary duty or similar material violation by the Company to the Company Board or any committee thereof or to any director or officer of the Company, in each case that remains pending or unresolved as of the date hereof.

**Section 3.10 Absence of Changes.** Since April 1, 2022, (a) to the date of this Agreement the Group Companies have operated their business in the Ordinary Course and collected receivables and paid payables and similar obligations in the Ordinary Course, and (b) there has not been any occurrence of any Company Material Adverse Effect.

**Section 3.11 Actions.** (a) There is no Action pending or, to the Knowledge of the Company, threatened in writing against or affecting the Company or any of its Subsidiaries, or any of their respective directors or officers (in their capacity as such) and (b) there is no judgment or award unsatisfied against the Company or any of its Subsidiaries, nor is there any Governmental Order in effect and binding on the Company or any of its Subsidiaries or their respective directors or officers (in their capacity as such) or assets or properties, except

in each case, as would not, individually or in the aggregate, (i) have, or reasonably be expected to have, a material adverse effect on the ability of the Company to enter into and perform its obligations contemplated hereby, or (ii) be or reasonably be expected to be material to the business of the Company and its Subsidiaries, taken as a whole. No order has been made, petition presented and received by any Group Company, resolution of any Group Company passed or meeting of any Group Company convened for the purpose of considering a resolution for the dissolution and liquidation of any Group Company or the establishment of a liquidation group of any Group Company, no administrator has been appointed for any Group Company nor to the Knowledge of the Company steps taken to appoint an administrator, and to the Knowledge of the Company there are no Actions under any applicable insolvency, bankruptcy or reorganization Laws concerning any Group Company.

**Section 3.12 Liabilities.** Neither the Company nor any of its Subsidiaries has any Liabilities, except for Liabilities (a) set forth in the Audited Financial Statements that have not been satisfied since April 1, 2022, (b) that are Liabilities incurred since April 1, 2022 in the Ordinary Course, (c) that are executory obligations under any Contract to which the Company or any of its Subsidiaries is a party or by which it is bound, (d) arising under this Agreement or other Transaction Documents, (e) that will be discharged or paid off prior to the Closing, or (f) which would not have a Company Material Adverse Effect.

**Section 3.13 Material Contracts and Commitments.**

(a) Section 3.13(a) of the Company Disclosure Letter contains a true and correct list of all Material Contracts as of the date of this Agreement and as of the date of this Agreement no Group Company is a party to or bound by any Material Contract that is not listed in Section 3.13(a) of the Company Disclosure Letter. Except as disclosed in Section 3.13(a) of the Company Disclosure Letter, true and complete copies of each Material Contract, including all material amendments, modification, supplements, exhibits and schedules and addenda thereto, have been Made Available to SPAC.

(b) Except for any Material Contract that will terminate upon the expiration of the stated term thereof prior to the Closing Date or the termination of which is otherwise contemplated by this Agreement, each Material Contract listed on Section 3.13(a) of the Company Disclosure Letter is (A) in full force and effect and (B) represents the legal, valid and binding obligations of the applicable Group Company which is a party thereto and, to the Knowledge of the Company, represents the legal, valid and binding obligations of the counterparties thereto. Except, in each case, where the occurrence of such breach or default or failure to perform would not be material to the business of the Company and its Subsidiaries, taken as a whole, (x) the applicable Group Company has duly performed all of its obligations under each such Material Contract as set forth in Section 3.13(a) of the Company Disclosure Letter to which it is a party to the extent that such obligations to perform have accrued, (y) no material breach or default thereunder by the Group Company with respect thereto, or, to the Knowledge of the Company any other party or obligor with respect thereto, has occurred, and (z) no event has occurred that with notice or lapse of time, or both, would constitute such a default or breach of such Material Contract by the Company or any of its Subsidiaries or, to the Knowledge of the Company, any other party thereto, or would entitle any third party to prematurely terminate any Material Contract.

(c) None of the Group Companies has within the last twelve (12) months provided to or received from the counterparty to any Material Contract any written notice or written communication to terminate, or not renew, any Material Contract.

**Section 3.14 Title; Properties.**

(a) Except as disclosed in Section 3.14 of the Company Disclosure Letter, each of the Group Companies has good and valid title to all of the assets (other than Intellectual Property, which in each case is addressed in Section 3.15) owned by it, whether tangible or intangible (including those reflected in the Audited Financial Statements, together with all assets (other than Intellectual Property, which in each case is addressed in Section 3.15) acquired thereby since April 1, 2022, but excluding any tangible or intangible assets that have been disposed of since April 1, 2022 in the Ordinary Course), and in each case free and clear of all Encumbrances, other than Permitted Encumbrances.

(b) No Group Company owns or has ever owned or has a leasehold interest in any real property other than as held pursuant to their respective leases or leasehold interests (including tenancies) in such property

(each Contract evidencing such interest, a “*Company Lease*”, and any Company Lease involving rent payments in excess of \$100,000 on an annual basis, a “*Company Material Lease*”). Section 3.14(b) of the Company Disclosure Letter sets forth as of the date of this Agreement each Company Material Lease and the address of the property demised or leased under each such Company Material Lease. Each Company Material Lease is in compliance with applicable Law in all material respects, and all Governmental Orders required under applicable Law in respect of any Company Material Lease have been obtained, including with respect to the operation of such property and conduct of business on such property as now conducted by the applicable Group Company which is a party to such Company Material Lease, except in any such case where the failure to so be in compliance or obtain such Governmental Order would not, individually or in the aggregate, be or reasonably be expected to be material to the business of the Company and its Subsidiaries, taken as a whole.

(c) Each Company Lease is a valid and binding obligation of the applicable Group Company, enforceable in accordance with its terms against such Group Company, and to the Knowledge of the Company, each other party thereto, subject to the Enforceability Exceptions. There is no material breach by the relevant Group Company under any Company Material Lease.

(d) To the Knowledge of the Company, no Person or Governmental Authority has challenged, disputed, or threatened in writing to challenge or dispute, a Group Company’s right to occupy, use or enjoy each leased real property subject to the Company Material Leases as such leased property is currently occupied, used or enjoyed.

(e) No Group Company has received any written notice alleging a material breach of any covenant, restriction, burden or stipulation from any person or Governmental Authority in relation to the existing use of any Leased Real Property, and to the Knowledge of the Company, no circumstance exists which constitutes a breach of this type or nature.

(f) No Group Company has received any written notice from the relevant lessor under any Company Material Lease to terminate or indicating its intention to terminate such Company Material Lease prior to the expiration of its term, and to the Knowledge of the Company, no circumstance exists (whether as a result or as contemplated under the Transactions or otherwise) which may entitle such lessor or landlord to do so.

### **Section 3.15 Intellectual Property Rights.**

(a) Section 3.15(a) of the Company Disclosure Letter sets forth a true, complete and accurate (in all material respects) list of all material Registered IP. Either the Company or its applicable Subsidiary has taken reasonable and appropriate steps to make required filings and registrations (and corresponding payments of fees therefor) to Governmental Authorities in connection with patents, registrations and applications for the Registered IP. Each item of material Registered IP is valid, subsisting, and to the Knowledge of the Company, enforceable. The Company and its Subsidiaries exclusively own and possess all right, title and interest in and to the material Owned IP, including each item of Registered IP, and exclusively own, or otherwise have a sufficient right to use pursuant to a valid and enforceable license or other right (in relation to which there is no current material dispute), all other material Company IP; in each case, free and clear of any Encumbrances other than Permitted Encumbrances.

(b) The operation of the business of the Company and its Subsidiaries as currently conducted does not violate, infringe, dilute, or misappropriate, and since April 1, 2020 has not violated, infringed, diluted or misappropriated any Intellectual Property of any Person except for any such violation, infringement, dilution, or misappropriation that would not reasonably be expected to be material to the Company and its Subsidiaries, taken as a whole, nor has the Company or any of its Subsidiaries received since April 1, 2020 any written notice, request for indemnification or threat relating to any of the foregoing (including in the form of any offer or request to license any Intellectual Property). No Action alleging misappropriation, infringement, dilution or violation by the Company or any of its Subsidiaries of the Intellectual Property of any Person or contesting the validity, ownership, use, registrability or enforceability (other than *ex parte* office actions and the like in the ordinary course of prosecution of applications and registrations) of any of the Owned IP is pending or, to the Knowledge of the Company, threatened in writing against the Company or any of its Subsidiaries. To the Knowledge of the Company, no Person is violating, infringing, diluting, or misappropriating or, since April 1, 2020, has violated, infringed, diluted or misappropriated any material Owned IP. Since April 1, 2020, neither the Company nor any of its Subsidiaries has given any written notice to any Person alleging any violation, infringement, dilution or misappropriation of any Owned IP, and no Actions relating to the same are pending.

(c) The Company and its Subsidiaries have adequate title to all materials necessary to compile and operate the Company Products as currently compiled and operated by the Company and its Subsidiaries and have not disclosed, delivered, licensed or otherwise made available (other than to Persons performing obligations for or on behalf of the Company and its Subsidiaries who have executed or otherwise are subject to a valid and enforceable agreements providing for restrictions on use of, and the nondisclosure of, the source code), and the Company and its Subsidiaries do not have a duty or obligation (whether present, contingent or otherwise) to disclose, deliver, license or otherwise make available, any source code included in any material Owned IP to any Person (other than to Persons performing obligations for or on behalf of the Company and its Subsidiaries who have executed or otherwise are subject to valid and enforceable Contracts providing for restrictions on use of, and the nondisclosure of, the source code).

(d) All Persons who have contributed, developed or conceived any material Intellectual Property for or on behalf of the Company or any of its Subsidiaries, have done so pursuant to a valid and enforceable agreement that protects the trade secrets and material confidential information of the Company and its Subsidiaries and grants the applicable Company or Subsidiary exclusive ownership of the Person's contribution, development and conception. Neither the Company nor any of its Subsidiaries has disclosed any trade secrets or material confidential Company IP to any Person other than pursuant to a valid and enforceable agreement providing for restrictions on use of, and the nondisclosure of, such trade secrets and confidential information. Since April 1, 2020, no Persons who have contributed, developed or conceived any Company IP have made or, to the Knowledge of the Company, threatened in writing any claims of ownership with respect to any Owned IP.

(e) The Company and its Subsidiaries have implemented and maintained reasonable and appropriate policies and technical and organizational security measures designed to protect the Company Systems, and business continuity and disaster recovery plans. The Company and its Subsidiaries have taken other reasonable steps consistent with industry practices of companies offering similar services designed to safeguard Trade Secrets, and all Software, computer hardware (whether general or special purpose), electronic data processing, information, record keeping, communications, telecommunications, networks, interfaces, platforms, servers, peripherals, and computer systems, to the extent owned or used or held for use by the Company or any of its Subsidiaries in the operation of the business of the Company and its Subsidiaries as currently conducted (together with the data and information stored therein or transmitted by any of the foregoing, collectively, the "*Company Systems*"), from the introduction of any virus, worm, Trojan horse or similar disabling code or program. There are and since April 1, 2020 have been no defects or other technical problems in Company Systems that would prevent the same from functioning substantially in accordance with their user specifications and functionality descriptions, and the Company and its Subsidiaries have received no written notice alleging any of the foregoing, except in each case as would not reasonably be expected to have a Company Material Adverse Effect. The Company and its Subsidiaries own, lease, license, or otherwise have the valid, legal right to use all Company Systems and have obtained a sufficient number of licenses (whether licensed by seats or otherwise) for their use of all Software (and the equivalent resources, including Software as a Service) encompassed by the Company Systems.

(f) The Company and its Subsidiaries have taken reasonable steps, consistent with industry practices of companies offering similar services, to protect and maintain the Owned IP, including the secrecy, confidentiality and value of any Trade Secrets contained therein, and the Company IP and Company Systems are sufficient for conduct of the business of the Group Companies as presently conducted and as conducted during the twelve months prior to the date of this Agreement. During the twelve (12) months prior to the date of this Agreement, there has been no material failure or other material substandard performance of any Company System, in each case, which has not been remedied in all material respects.

### **Section 3.16 Labor and Employee Matters.**

(a) Except as those which would not be material to the business of the Group taken as a whole, (i) the Company and each of its Subsidiaries is in compliance with all applicable Law in all material respects related to labor or employment, including provisions thereof relating to wages and payrolls, working hours and resting hours, overtime, working conditions, benefits, recruitment, retrenchment, retirement, pension, minimum employment and retirement age, equal opportunity, discrimination, worker classification, occupational health and safety, wrongful discharge, layoffs or plant closings, immigration, employees provident fund, social security organization and collective bargaining, trade union, compulsory employment insurance, work and

residence permits, public holiday and leaves, labor disputes, statutory labor or employment reporting and filing obligations and contracting arrangements; (ii) there is no Action pending or, to the Knowledge of the Company, threatened relating to the violation of any applicable Law by the Company or any of its Subsidiaries related to labor or employment, including any charge or complaint filed by any of its current or former employees, directors, officers or individual service providers with any Governmental Authority or the Company or any of its Subsidiaries, except where the amount in controversy does not exceed \$100,000 individually or \$500,000 in the aggregate; and (iii) the Company and its Subsidiaries have, where required by applicable Law, properly classified for all purposes (including (x) for Tax purposes, (y) for purposes of minimum wage and overtime and (z) for purposes of determining eligibility to participate in any statutory Benefit Plan) all Persons who have performed services for or on behalf of each such entity, and have properly withheld and paid all applicable Taxes and statutory contributions and made all required filings in connection with services provided by such persons to the Company and its Subsidiaries in accordance with such classifications.

**(b)** Except those which would not be material to the business of the Group taken as a whole, (i) each of the Benefit Plans has been operated and administered in accordance with its terms, and is in compliance with all applicable Law in all material respects, and all contributions to each such Benefit Plan have been timely made, and, to the Knowledge of the Company, no event, transaction or condition has occurred or exists that would result in any Liability to any of the Company and any of its Subsidiaries under such Benefit Plan; (ii) there is no pending or, to the Knowledge of the Company, threatened in writing Actions involving any Benefit Plan (except for routine claims for benefits payable in the normal operation of any Benefit Plan) and to the Knowledge of the Company, no facts or circumstances exist that could give rise to any such Actions; (iii) no Benefit Plan is under investigation or audit by any Governmental Authority and, to the Knowledge of the Company, no such investigation or audit is contemplated or under consideration; and (iv) the Company and each of its Subsidiaries is in compliance with all applicable Laws and Contracts in all material respects relating to its provision of any form of social insurance, and has paid, or made provision for the payment of, all social insurance contributions required under applicable Law and Contracts.

**(c)** Neither the execution or delivery of any of the Transaction Documents to which the Company is a party nor the consummation of the transactions contemplated thereunder (either alone or in combination with another event) would reasonably be expected to (i) result in any payment or benefit becoming due or payable to any current or former director, officer, employee, or individual service provider of the Company or any of its Subsidiaries; (ii) increase the amount of compensation or any benefits otherwise payable under any of the Benefit Plans; (iii) result in any acceleration of the time of payment, exercisability, funding or vesting of, or provide any additional rights or benefits with respect to, any compensation or benefits payable to any current or former director, officer, employee or individual service provider of the Company or its Subsidiary; (iv) limit or restrict the ability of the Company to merge, amend, or terminate any Benefit Plan; or (v) result in any “excess parachute payments” within the meaning of Section 280G(b) of the Code.

**(d)** Each Benefit Plan that constitutes in any part a nonqualified deferred compensation plan within the meaning of Section 409A of the Code has been operated and maintained in all material respects in operational and documentary compliance with Section 409A of the Code and applicable guidance thereunder.

**(e)** The Company and its Subsidiary do not have any obligation to “gross-up” or otherwise indemnify any individual for any excise Tax imposed under Sections 4999 or 409A of the Code.

**(f)** Neither the Company nor any of its Subsidiaries or any ERISA Affiliate thereof has any Liability with respect to or under: (i) a “multiemployer plan” within the meaning of Section 3(37) or 4001(a)(3) of ERISA; (ii) a “defined benefit plan” (as defined in Section 3(35) of ERISA, whether or not subject to ERISA) or a plan that is or was subject to Title IV of ERISA or Section 412 of the Code; or (iii) a “multiple employer plan” within the meaning of Section 413(c) of the Code or Section 210 of ERISA. No Benefit Plan is subject to ERISA or the Code or U.S. Law.

**(g)** Except as would not have a Company Material Adverse Effect, as of the date of this Agreement (i) no employee of the Company or any of its Subsidiaries is represented by a Union, (ii) neither the Company nor any of its Subsidiaries is negotiating any collective bargaining agreement or other Contract with any Union, (iii) to the Knowledge of the Company, there is no effort currently being made or threatened by or on behalf of any Union to organize any employees of the Company or any of its Subsidiaries, and (iv) there is no

Action pending or, to the Knowledge of the Company, threatened against the Company or any of its Subsidiaries relating to labor disputes where the amount in controversy exceeds \$100,000 individually or \$500,000 in the aggregate (including any work slowdown, lockout, stoppage, picketing or strike). No notice, consent or consultation obligations with respect to any employee of the Company or any of its Subsidiaries or any Union will be a condition precedent to, or triggered by, the execution of this Agreement or the consummation of the transactions contemplated hereby.

**Section 3.17 Brokers.** No broker, finder or investment banker is entitled to any brokerage, finder's or other fee or commission or expense reimbursement in connection with the Transactions contemplated based upon arrangements made by and on behalf of the Company or any of its Controlled Affiliates.

**Section 3.18 Environmental Matters.** Except as those which would not cause a Company Material Adverse Effect to the business of the Company and its Subsidiaries, taken as a whole (i) the Group Companies are in compliance in all material respects with the applicable Environmental Laws in the respective jurisdictions where they conduct their business, including obtaining and complying in all material respects with all permits, licenses, consents and other authorizations required pursuant to applicable Environmental Laws for the lawful operation of their business as currently conducted; and (ii) no Group Company has since April 1, 2020 received any written notice of any actual or alleged material non-compliance with or material liability under Environmental Laws.

**Section 3.19 Insurance.** Section 3.19 of the Company Disclosure Letter sets forth a true and accurate list of all of the material insurance policies of the Group Companies other than the statutory employee benefit plans mandated by applicable Laws. Each of the Group Companies has insurance policies covering such risks as are customarily carried by Persons conducting business in the industries and geographies in which the Group Companies operate. All such policies are in full force and effect, all premiums due and payable thereon as of the date of this Agreement have been paid in full as of the date of this Agreement. To the Knowledge of the Company, (a) no material claims have been made which remain outstanding and unpaid under such insurance policies, (b) no circumstances exist that would reasonably be expected to give rise to a material claim of under such insurance policies, and (c) there are no circumstances which might lead to any liability under such insurance policies of the Group being avoided to a material extent or rendered unenforceable by the relevant insurers or otherwise materially reduce the amount recoverable under any policy of this type.

**Section 3.20 Company Related Parties.** The Company has not engaged in any material transactions with Related Parties other than those required to be disclosed in the Proxy/Registration Statement.

**Section 3.21 Proxy/Registration Statement.** The information supplied or to be supplied by the Company, any of its Subsidiaries or their respective Representatives in writing specifically for inclusion in the Proxy/Registration Statement shall not, at (a) the time the Proxy/Registration Statement is declared effective, (b) the time the Proxy/Registration Statement (or any amendment thereof or supplement thereto) is first mailed to the SPAC Shareholders, and (c) the time of the SPAC Shareholders' Meeting, contain any untrue statement of a material fact or omit to state any material fact required to be stated therein or necessary in order to make the statements therein, in light of the circumstances under which they were made, not misleading. Notwithstanding the foregoing, the Company makes no representation, warranty or covenant with respect to any information supplied by or on behalf of SPAC, its Affiliates or their respective Representatives.

**Section 3.22 Foreign Private Issuer.** The Company is and shall be at all times commencing from the date 30 days prior to the first filing of the Proxy/Registration Statement with the SEC through the Closing, (a) a foreign private issuer as defined in Rule 405 under the Securities Act and (b) an "emerging growth company" as that term is defined in the JOBS Act.

**Section 3.23 No Additional Representation or Warranties.** Except as set forth in Article IV and Section 11.1, the Company acknowledges and agrees that the SPAC is not making any representation or warranty whatsoever to the Company pursuant to this Agreement.

## ARTICLE IV

### REPRESENTATIONS AND WARRANTIES OF SPAC

Except (a) as set forth in any SPAC SEC Filings filed or submitted on or prior to the date hereof (excluding (i) any disclosures in any risk factors section that do not constitute statements of fact, any

disclosures in any forward-looking statements disclaimer and any other disclosures that are generally cautionary, predictive or forward-looking in nature and (ii) any exhibits or other documents appended thereto) (it being acknowledged that nothing disclosed in such SPAC SEC Filings will be deemed to modify or qualify the representations and warranties set forth in Section 4.2, Section 4.6 and Section 4.13); (b) as set forth in the disclosure letter delivered by SPAC to the Company on the date of this Agreement (the “*SPAC Disclosure Letter*”) or (c) as otherwise explicitly contemplated by this Agreement, SPAC represents and warrants to the Company as of the date of this Agreement as follows:

**Section 4.1 Organization, Good Standing, Corporate Power and Qualification.** SPAC is an exempted company duly incorporated, validly existing and in good standing under the Laws of the Cayman Islands and has requisite corporate power and authority to own and operate its properties and assets, to carry on its business as presently conducted and contemplated to be conducted. SPAC is duly licensed or qualified and in good standing as a foreign or extra-provincial corporation in each jurisdiction in which its ownership of property or the character of its activities is such as to require it to be so licensed or qualified or in good standing, as applicable, except where the failure to be so licensed or qualified or in good standing would not be material to SPAC. Prior to the execution of this Agreement, a true and correct copy of the SPAC Charter has been made available by or on behalf of SPAC to the Company, the SPAC Charter is in full force and effect, and SPAC is not in default of any term of provision of the SPAC Charter in any material respect. SPAC is not insolvent, bankrupt or unable to pay its debts as and when they fall due.

**Section 4.2 Capitalization and Voting Rights.**

**(a) Capitalization of SPAC.** As of the date of this Agreement, the authorized share capital of SPAC consists of \$55,500 divided into (i) 500,000,000 SPAC Class A Ordinary Shares, of which 20,000,000 SPAC Class A Ordinary Shares are issued and outstanding as of the date of this Agreement, (ii) 50,000,000 SPAC Class B Ordinary Shares, of which 5,750,000 SPAC Class B Ordinary Shares are issued and outstanding as of the date of this Agreement, and (iii) 5,000,000 SPAC Preference Shares, of which no SPAC Preference Share is issued and outstanding as of the date of this Agreement. There are no other issued or outstanding SPAC Shares as of the date of this Agreement. All of the issued and outstanding SPAC Shares (i) have been duly authorized and validly issued and allotted and are fully paid and non-assessable; (ii) have been offered, sold and issued by SPAC in compliance with applicable Law, including the Cayman Act, U.S. federal and state securities Laws, and all requirements set forth in (1) the SPAC Charter, and (2) any other applicable Contracts governing the issuance or allotment of such securities to which SPAC is a party or otherwise bound; and (iii) are not subject to, nor have they been issued in violation of, any Encumbrance, purchase option, call option, pre-emptive right, subscription right or any similar right under any provision of any applicable Law, the SPAC Charter or any Contract to which SPAC is a party or otherwise bound.

**(b)** As at the date of this Agreement, 20,000,000 SPAC Units are issued and outstanding (in respect of which 20,000,000 SPAC Class A Ordinary Shares and up to 10,000,000 SPAC Warrants would be issued if these SPAC Units were separated on the date hereof pursuant to Section 2.2(h)(i)). There are no other issued or outstanding SPAC Units as of the date of this Agreement. All of the issued and outstanding SPAC Units (i) have been duly authorized and validly issued; (ii) have been offered, sold and issued by SPAC in compliance with applicable Law, including the Cayman Act, U.S. federal and state securities Laws, and all requirements set forth in (1) the SPAC Charter, and (2) any other applicable Contracts governing the issuance of such SPAC Units to which SPAC is a party or otherwise bound; and (iii) are not subject to, nor have they been issued in violation of, any Encumbrance, purchase option, call option, pre-emptive right, subscription right or any similar right under any provision of any applicable Law, the SPAC Charter or any Contract to which SPAC is a party or otherwise bound.

**(c)** As of the date of this Agreement, up to 16,000,000 SPAC Warrants are issued and outstanding, each exercisable for one SPAC Class A Ordinary Share at an exercise price of \$11.50, including (i) up to 10,000,000 SPAC Warrants that would be issued if all SPAC Units were separated on the date hereof pursuant to Section 2.2(h)(i) and (ii) 6,000,000 SPAC Warrants issued to Sponsor in a private placement concurrently with the IPO. The SPAC Warrants are not exercisable until the later of (x) thirty (30) days after the closing of a Business Combination and (y) one (1) year from the closing of the IPO. All outstanding SPAC Warrants (i) have been duly authorized and validly issued and constitute valid and binding obligations of SPAC, enforceable against SPAC in accordance with their terms, subject to the Enforceability Exceptions; (ii) have been offered, sold and issued by SPAC in compliance with applicable Law, including federal and state securities



Laws, and all requirements set forth in (1) the SPAC Charter and (2) any other applicable Contracts governing the issuance of such securities to which SPAC is a party or otherwise bound; and (iii) are not subject to, nor have they been issued in violation of, any Encumbrance, purchase option, call option, pre-emptive right, subscription right or any similar right under any provision of any applicable Law, the SPAC Charter or any Contract to which SPAC is a party or otherwise bound. Except for the SPAC Charter, the Forward Purchase Agreements, this Agreement or the issuance of up to 1,000,000 SPAC Class A Ordinary Shares in connection with the exercise of SPAC Warrants issued upon conversion of any Working Capital Loan in an aggregate amount not exceeding \$1,500,000, there are no outstanding Contracts of SPAC to issue, repurchase, redeem or otherwise acquire any SPAC Shares.

(d) Except as set forth in this Section 4.2 or Section 4.2 of the SPAC Disclosure Letter, there are no outstanding subscriptions, options, warrants, rights or other securities (including debt securities) of SPAC exercisable or exchangeable for SPAC Shares, any other commitments, calls, conversion rights, rights of exchange or privilege (whether pre-emptive, contractual or by matter of Law), plans or other agreements of any character providing for the issuance of additional shares, the sale of treasury shares or other Equity Securities of SPAC, or for the repurchase or redemption by SPAC of shares or other Equity Securities of the SPAC or the value of which is determined by reference to shares or other Equity Securities of the SPAC, and there are no voting trusts, proxies or agreements of any kind which may obligate SPAC to issue, purchase, register for sale, redeem or otherwise acquire any SPAC Shares or other Equity Securities of SPAC.

**Section 4.3 Corporate Structure; Subsidiaries.** SPAC has no Subsidiary, and does not own, directly or indirectly, any Equity Securities or other interests or investments (whether equity or debt) in any Person, whether incorporated or unincorporated. SPAC is not obligated to make any investment in or capital contribution to or on behalf of any other Person.

**Section 4.4 Authorization.**

(a) Other than the SPAC Shareholders' Approval, SPAC has all requisite corporate power and authority to (i) enter into, execute, and deliver this Agreement and each of the other Transaction Documents to which it is or will be a party, and (ii) consummate the transactions contemplated hereby and thereby (including the Transactions) and perform all of its obligations hereunder and thereunder. The execution and delivery of this Agreement and the other Transaction Documents to which SPAC is a party and the consummation of the transactions contemplated hereby and thereby (including the Transactions) have been duly and validly authorized and approved by the SPAC Board and, other than the SPAC Shareholders' Approval, no other company or corporate proceeding on the part of SPAC is necessary to authorize this Agreement and the other Transaction Documents to which SPAC is a party and to consummate the transactions contemplated hereby and thereby (including the Transactions). This Agreement has been, and at or prior to the Closing, the other Transaction Documents to which SPAC is a party will be, duly and validly executed and delivered by SPAC, and this Agreement constitutes, and on or prior to the Closing, the other Transaction Documents to which SPAC is a party will constitute, a legal, valid and binding obligation of SPAC, enforceable against SPAC in accordance with its terms, subject to the Enforceability Exceptions.

(b) Assuming that a quorum (as determined pursuant to the SPAC Charter) is present:

(i) The approval and authorization of the Mergers and the Plans of Merger shall require approval by a special resolution passed by the affirmative vote of SPAC Shareholders holding at least two-thirds of the outstanding SPAC Shares which, being so entitled, are voted thereon in person or by proxy at a general meeting of SPAC of which notice specifying the intention to propose the resolution as a special resolution has been duly given, pursuant to the terms and subject to the conditions of the SPAC Charter and applicable Law; and

(ii) The approval and authorization of this Agreement and the Transactions as a Business Combination and the adoption and approval of a proposal for the adjournment of the SPAC Shareholders' Meeting in each case shall require approval by an ordinary resolution passed by the affirmative vote of SPAC Shareholders holding at least a majority of the outstanding SPAC Shares which, being so entitled, are voted thereon in person or by proxy at a general meeting of SPAC, pursuant to the terms and subject to the conditions of the SPAC Charter and applicable Law.

(c) The SPAC Shareholders' Approval are the only votes and approvals of holders of SPAC Shares necessary in connection with execution of this Agreement and the other Transaction Documents to which SPAC is a party by SPAC and the consummation of the transactions contemplated hereby, including the Closing.

(d) On or prior to the date of this Agreement, the SPAC Board has duly adopted resolutions (i) determining that this Agreement and the other Transaction Documents to which SPAC is a party contemplated hereby and the transactions contemplated hereby and thereby (including the Transactions) are advisable and fair to, and in the best interests of, SPAC and constitute a Business Combination, (ii) authorizing and approving the execution, delivery and performance by SPAC of this Agreement and the other Transaction Documents to which SPAC is a party contemplated hereby and the transactions contemplated hereby and thereby (including the Transactions), (iii) making the SPAC Board Recommendation, and (iv) directing that this Agreement, the Transaction Documents and the Transactions be submitted to the SPAC Shareholders for adoption at an extraordinary general meeting called for such purpose pursuant to the terms and conditions of this Agreement.

**Section 4.5 Consents; No Conflicts.** Assuming the representations and warranties in Article III are true and correct, except (a) as otherwise set forth in Section 4.5 of the SPAC Disclosure Letter, (b) for the SPAC Shareholders' Approval, (c) for the registration or filing with the Registrar of Companies of the Cayman Islands and the publication of notification of the Mergers in the Cayman Islands Government Gazette in accordance with the Cayman Act, the SEC or applicable state blue sky or other securities laws filings with respect to the Transactions and (d) for such other filings, notifications, notices, submissions, applications, or consents the failure of which to be obtained or made would not individually or in the aggregate, have, or reasonably be expected to have, a material adverse effect on the ability of SPAC to enter into and perform its obligations under this Agreement, all filings, notifications, notices, submissions, applications, or consents from or with any Governmental Authority or any other Person required in connection with the valid execution, delivery and performance of this Agreement and the other Transaction Documents, and the consummation of the Transactions, in each case on the part of SPAC, have been or will be duly obtained or completed (as applicable) and are or will be in full force and effect. The execution, delivery and performance of this Agreement and the other Transaction Documents to which it is or will be a party by SPAC does not, and the consummation by SPAC of the transactions contemplated hereby and thereby will not (assuming the representations and warranties in Article III are true and correct, except for the matters referred to in clauses (a) through (d) of the immediately preceding sentence) (i) result in any violation of, be in conflict with, or constitute a default under, require any consent under, or give any Person rights of termination, amendment, acceleration (including acceleration of any obligation of SPAC) or cancellation under, (A) any Governmental Order, (B) the SPAC Charter, (C) any applicable Law, (D) any Contract to which SPAC is a party or by which its assets are bound, or (ii) result in the creation of any Encumbrance upon any of the properties or assets of SPAC other than any restrictions under federal or state securities laws, this Agreement or the SPAC Charter, except in the case of sub-clauses (A), (C), and (D) of clause (i) or clause (ii), as would not have a SPAC Material Adverse Effect.

**Section 4.6 Tax Matters.**

(a) All income and other material Tax Returns required to be filed by or with respect to SPAC have been filed within the requisite period (taking into account any valid extensions properly obtained) and such Tax Returns are true, correct, and complete in all material respects. All income and other material Taxes due and payable by SPAC have been or will be paid in a timely fashion. SPAC has withheld and paid over to the appropriate Governmental Authority all material Taxes that it is required to withhold from amounts paid or owing to any employee, independent contractor, member, equityholder, creditor, or other Person.

(b) No material deficiencies for any Taxes that are currently outstanding with respect to any Tax Returns of SPAC have been asserted in writing by any Governmental Authority. No written notice of any action, audit, assessment, or other proceeding, in each case that is currently pending, with respect to any Tax Returns or any Taxes of SPAC has been received from any Governmental Authority. No dispute or assessment relating to such Tax Returns or such Taxes with any Governmental Authority is currently outstanding. SPAC has not consented to any extension or waiver of the time within which any Tax may be assessed or collected by a Governmental Authority, which extension or waiver remains in force.

(c) SPAC does not have any material liability for unpaid Taxes which has not been accrued or reserved on its most recent financial statements, whether asserted or unasserted, contingent, or otherwise, and SPAC has not incurred any material liability of Taxes outside the Ordinary Course since the date of such financial statements.

(d) SPAC is not a Tax resident of any jurisdiction other than its jurisdiction of incorporation. No written claim that is currently outstanding has been made by a Governmental Authority in a jurisdiction where SPAC does not file Tax Returns that SPAC is or may be subject to taxation by that jurisdiction.

(e) There are no liens for Taxes (other than Permitted Encumbrances) upon the assets of SPAC.

(f) SPAC has not been a member of an affiliated, consolidated, or similar Tax group and otherwise does not have any liability for the Taxes of any other Person under Treasury Regulations Section 1.1502-6 or any similar provision of state, local, or non-U.S. Law, as a transferee or successor, or by Contract (including any Tax sharing, allocation, or similar agreement or arrangement but excluding any commercial Contract entered into in the Ordinary Course and not primarily relating to Taxes).

(g) SPAC has complied in all material respects with all applicable transfer pricing requirement Laws.

(h) SPAC is in compliance in all material respects with all terms and conditions of any Tax incentives, exemption, holiday, or other Tax reduction agreement or order of a Governmental Authority applicable to SPAC, and the consummation of the Transactions will not have any material adverse effect on the continued validity and effectiveness of any such Tax incentives, exemption, holiday, or other Tax reduction agreement or order.

(i) SPAC is registered for value added and similar Taxes in each jurisdiction it is required to be so registered. SPAC has complied in all material respects with all applicable value added and similar Tax Laws.

#### **Section 4.7 Financial Statements.**

(a) The financial statements of SPAC contained in SPAC SEC Filings (the “*SPAC Financial Statements*”) (i) have been prepared in accordance with the books and records of SPAC, (ii) fairly present in all material respects the financial condition of SPAC on a consolidated basis as of the dates indicated therein, and the results of operations and cash flows of SPAC on a consolidated basis for the periods indicated therein, (iii) were prepared in accordance with GAAP applied on a consistent basis throughout the periods involved, and (iv) comply in all material respects with the applicable accounting requirements and with the rules and regulations of the SEC, the Exchange Act and the Securities Act applicable to SPAC, in effect as of the respective dates thereof (including, to the extent applicable to SPAC, Regulation S-X).

(b) SPAC has in place disclosure controls and procedures that are (i) designed to reasonably ensure that material information relating to SPAC is made known to the management of SPAC by others within SPAC; and (ii) effective in all material respects to perform the functions for which they were established. SPAC maintains a system of internal accounting controls sufficient to provide reasonable assurance that (w) transactions are executed in accordance with management’s general or specific authorizations, (x) transactions are recorded as necessary to permit preparation of financial statements in conformity with GAAP and to maintain asset accountability, (y) access to assets is permitted only in accordance with management’s general or specific authorization and (z) the recorded accountability for assets is compared with the existing assets at reasonable intervals and appropriate action is taken with respect to any differences.

(c) SPAC has no Liability, and there is no existing condition, situation or set of circumstances which is reasonably expected to result in any Liability, other than (i) Liabilities incurred after the SPAC Accounts Date in the Ordinary Course or other Liabilities that individually and in the aggregate are immaterial, (ii) Liabilities reflected, or reserved against, in the SPAC Financial Statements or (iii) as set forth in Section 4.7(c) of the SPAC Disclosure Letter.

(d) Since the SPAC Accounts Date, none of SPAC’s directors has been made aware of (i) any fraud that involves SPAC’s management who have a role in the preparation of financial statements or the internal accounting controls utilized by SPAC or (ii) any allegation, assertion or claim that SPAC has engaged in any material questionable accounting or auditing practices which violate applicable Law. Since the SPAC Accounts Date, no attorney representing SPAC, whether or not employed by SPAC, has reported a material violation of

securities Laws, breach of fiduciary duty or similar material violation by SPAC to the SPAC Board or any committee thereof or to any director or officer of SPAC.

**Section 4.8 Absence of Changes.** Since the SPAC Accounts Date, (i) to the date of this Agreement SPAC has operated its business in the Ordinary Course, and (ii) there has not been any SPAC Material Adverse Effect.

**Section 4.9 Actions.** (a) There is no Action pending or, to the Knowledge of SPAC, threatened in writing against or affecting SPAC, or any of its directors or officers (in their capacity as such) and (b) there is no judgment or award unsatisfied against SPAC, nor is there any Governmental Order in effect and binding on SPAC or its directors or officers (in their capacity as such) or assets or properties, except in each case, as would not, individually or in the aggregate, (i) have, or reasonably be expected to have, a material adverse effect on the ability of SPAC to enter into and perform its obligations contemplated hereby, or (ii) be or reasonably be expected to be material to SPAC. No order has been made, petition presented and received by SPAC, resolution passed or meeting convened for the purpose of considering a resolution for the dissolution and liquidation of SPAC or the establishment of a liquidation group, no administrator has been appointed for SPAC nor to the Knowledge of SPAC steps taken to appoint an administrator, and to the Knowledge of SPAC there are no Actions under any applicable insolvency, bankruptcy or reorganization Laws concerning SPAC.

**Section 4.10 Brokers.** Except as set forth in Section 4.10 of the SPAC Disclosure Letter, no broker, finder or investment banker is entitled to any brokerage, finder's or other fee or commission or expense reimbursement in connection with the Transactions contemplated based upon arrangements made by and on behalf of SPAC or any of its Affiliates.

**Section 4.11 Proxy/Registration Statement.** The information supplied or to be supplied by SPAC, its Affiliates or their respective Representatives in writing specifically for inclusion in the Proxy/Registration Statement shall not, at (a) the time the Proxy/Registration Statement is declared effective, (b) the time the Proxy/Registration Statement (or any amendment thereof or supplement thereto) is first mailed to the SPAC Shareholders, and (c) the time of the SPAC Shareholders' Meeting, contain any untrue statement of a material fact or omit to state any material fact required to be stated therein or necessary in order to make the statements therein, in light of the circumstances under which they were made, not misleading. Notwithstanding the foregoing, SPAC makes no representation, warranty or covenant with respect to any information supplied by or on behalf of Company, its Subsidiaries (including the Merger Subs) or their respective Affiliates or Representatives. All documents that SPAC is responsible for filing with the SEC in connection with the Transactions will comply as to form and substance in all material respects with the applicable requirements of the Securities Act and the Exchange Act.

**Section 4.12 SEC Filings.** Except for its Quarterly Report on Form 10-Q for the fiscal quarter ended September 30, 2021, SPAC has timely filed or furnished all statements, prospectuses, registration statements, forms, reports and documents required to be filed or furnished by it with the SEC, pursuant to the Exchange Act or the Securities Act (collectively, as they have been amended since the time of their filing or furnishing through the date of this Agreement, the "*SPAC SEC Filings*"). Except as otherwise disclosed in its Current Report on Form 8-K filed with the SEC on November 22, 2021, each of the SPAC SEC Filings, as of the respective date of its filing, and as of the date of any amendment, complied in all material respects with the requirements of the Securities Act, the Exchange Act or the Sarbanes-Oxley Act applicable to such SPAC SEC Filings. As of the respective date of its filing (or if amended or superseded by a filing prior to the date of this Agreement or the Closing Date, then on the date of such filing), the SPAC SEC Filings did not contain any untrue statement of a material fact or omit to state any material fact required to be stated therein or necessary in order to make the statements made therein, in light of the circumstances under which they were made, not misleading. As of the date of this Agreement, there are no outstanding or unresolved comments in comment letters received from the SEC with respect to any SPAC SEC Filing. To the Knowledge of SPAC, none of the SPAC SEC Filings filed on or prior to the date of this Agreement is subject to ongoing SEC review or investigation as of the date of this Agreement.

**Section 4.13 Trust Account.** As of the date of this Agreement, SPAC has at least \$200,000,000 in the Trust Account, such monies invested in United States government securities or money market funds meeting certain conditions under Rule 2a-7 promulgated under the Investment Company Act pursuant to the Investment Management Trust Agreement, dated as of June 8, 2021, between SPAC and Continental Stock

Transfer & Trust Company, as trustee (in such capacity, the “*Trustee*”, and such Investment Management Trust Agreement, the “*Trust Agreement*”). Except for the BofA Waiver Letter, there are no separate Contracts or side letters that would cause the description of the Trust Agreement in the SPAC SEC Filings to be inaccurate in any material respect or that would entitle any Person (other than SPAC Shareholders holding SPAC Ordinary Shares (prior to the First Merger Effective Time) sold in SPAC’s IPO who shall have elected to redeem their SPAC Ordinary Shares (prior to the First Merger Effective Time) pursuant to the SPAC Charter) to any portion of the proceeds in the Trust Account. Prior to the Closing, none of the funds held in the Trust Account may be released other than to pay Taxes and payment to SPAC Shareholders who have validly exercised their redemption rights pursuant to the SPAC Charter. There are no Actions pending or, to the Knowledge of SPAC, threatened with respect to the Trust Account. SPAC has performed all material obligations required to be performed by it to date under, and is not in default, breach or delinquent in performance or any other respect (claimed or actual) in connection with, the Trust Agreement, and no event has occurred which, with due notice or lapse of time or both, would constitute such a default or breach thereunder. As of the Closing, the obligations of SPAC to dissolve or liquidate pursuant to the SPAC Charter shall terminate, and as of the Closing, SPAC shall have no obligation whatsoever pursuant to the SPAC Charter to dissolve and liquidate the assets of SPAC by reason of the consummation of the Transactions. As of the date of this Agreement, following the Closing, no SPAC Shareholder is entitled to receive any amount from the Trust Account except to the extent such SPAC Shareholder has exercised his, her or its SPAC Shareholder Redemption Right. As of the date of this Agreement, assuming the accuracy of the representations and warranties contained in Article III and the compliance by each of the Company and the Merger Subs with its obligations hereunder, SPAC has no reason to believe that any of the conditions to the use of funds in the Trust Account will not be satisfied or funds available in the Trust Account will not be available to the Surviving Company (as the surviving entity in the Second Merger) on the Closing Date.

**Section 4.14 Investment Company Act; JOBS Act.** SPAC is not an “investment company” or a Person directly or indirectly “controlled” by or acting on behalf of an “investment company”, in each case within the meaning of the Investment Company Act. SPAC constitutes an “emerging growth company” within the meaning of the Jumpstart Our Business Startups Act of 2012 (the “*JOBS Act*”).

**Section 4.15 Business Activities.**

(a) Since its incorporation, SPAC has not conducted any business activities other than activities related to SPAC’s IPO or directed toward the accomplishment of a Business Combination. Except as set forth in the SPAC Charter or as otherwise contemplated by the Transaction Documents and the Transactions, there is no Contract to which SPAC is a party which has or would reasonably be expected to have the effect of prohibiting or impairing in any material respect any business practice of SPAC or any acquisition of property by SPAC or the conduct of business by SPAC as currently conducted or as contemplated to be conducted as of the Closing.

(b) Except for the Transactions, SPAC does not own or have a right to acquire, directly or indirectly, any interest or investment (whether equity or debt) in any corporation, partnership, joint venture, business, trust or other entity. Except for this Agreement and the Transaction Documents and the transactions contemplated hereby and thereby, SPAC has no material interests, rights, obligations or liabilities with respect to, and is not party to, bound by or has its assets or property subject to, in each case whether directly or indirectly, any Contract or transaction which is, or would reasonably be interpreted as constituting, a Business Combination.

(c) Except for the Contracts disclosed in Section 4.15(d) of the SPAC Disclosure Letter, this Agreement and the other Transaction Documents to which it is party and the transactions contemplated hereby and thereby (including with respect to SPAC Transaction Expenses and Working Capital Loan), SPAC is not party to any Contract with any other Person that would require payments by SPAC after the date hereof in excess of \$100,000 in the aggregate.

(d) Section 4.15(d) of the SPAC Disclosure Letter contains a true and correct list of all Material Contracts of SPAC as of the date of this Agreement (including each Contract that would require payments by SPAC after the date hereof in excess of \$100,000 in the aggregate) and as of the date of this Agreement SPAC is not a party to or bound by any Material Contract that is not listed in Section 4.15(d) of the SPAC Disclosure Letter. Except as disclosed in Section 4.15(d) of the SPAC Disclosure Letter, true and complete copies of each Material Contract of SPAC, including all material amendments, modification, supplements, exhibits and schedules and addenda thereto, have been Made Available to the Company.

**Section 4.16 Nasdaq Quotation.** SPAC Class A Ordinary Shares, SPAC Warrants and SPAC Units are each registered pursuant to Section 12(b) of the Exchange Act and are listed for trading on Nasdaq under the symbol “*SMIH*”, “*SMIHW*” and “*SMIHU*”, respectively. SPAC is in compliance with the rules of Nasdaq and the rules and regulations of the SEC related to such listing and there is no Action pending or, to the Knowledge of SPAC, threatened against SPAC by Nasdaq or the SEC with respect to any intention by such entity to deregister SPAC Class A Ordinary Shares, SPAC Warrants or SPAC Units or terminate the listing thereof on Nasdaq. SPAC has not taken any action in an attempt to terminate the registration of SPAC Class A Ordinary Shares, SPAC Warrants or SPAC Units under the Exchange Act except as contemplated by this Agreement. SPAC has not received any notice from the Nasdaq or the SEC regarding the revocation of such listing or otherwise regarding the delisting of the SPAC Class A Ordinary Shares or the SPAC Warrants from the Nasdaq or the SEC.

**Section 4.17 Forward Purchase Subscriptions.**

(a) SPAC has delivered to the Company true, correct and complete copies of each of the Forward Purchase Agreements, pursuant to which the Forward Purchase Investors have committed to provide equity financing to SPAC solely for purposes of consummating the Forward Purchase Subscriptions in the aggregate amount of \$30,000,000 (the “*Forward Purchase Investment Amount*”). With respect to each Forward Purchase Investor, the Forward Purchase Agreement with such Forward Purchase Investor is in full force and effect and has not been withdrawn or terminated, or otherwise amended or modified, in any material respect, and no withdrawal or termination, or amendment or modification in any material respect is contemplated by SPAC. Each Forward Purchase Agreement is a legal, valid and binding obligation of SPAC and each Forward Purchase Investor, and neither the execution or delivery by any party thereto nor the performance of any party’s obligations under any such Forward Purchase Agreement violates any Laws. The Forward Purchase Agreements contain all of the conditions precedent (other than the conditions contained in the other Transaction Documents) to the obligations of the Forward Purchase Investors to fund the applicable portion of the Forward Purchase Investment Amount set forth in the Forward Purchase Agreements on the terms therein.

(b) There are no other agreements, side letters, or arrangements between SPAC and any Forward Purchase Investor relating to any Forward Purchase Agreement that could affect in any material respect the obligation of such Forward Purchase Investor to fund the applicable portion of the Forward Purchase Investment Amount set forth in the Forward Purchase Agreement of such Forward Purchase Investor and, as of the date of this Agreement, SPAC does not know of any facts or circumstances that may reasonably be expected to result in any of the conditions set forth in any Forward Purchase Agreement not being satisfied, or the Forward Purchase Investment Amount not being made available to the Company on the Closing Date consistent with the terms and conditions hereof including Section 9.3(c). To the Knowledge of SPAC, no event has occurred that, with or without notice, lapse of time or both, would constitute a default or breach under any material term or condition of any Forward Purchase Agreement and, as of the date of this Agreement, the SPAC does not have a reason to believe that any Forward Purchase Investor will be unable to satisfy in all material respects on a timely basis any term or condition of closing to be satisfied by it contained in any Forward Purchase Agreement. No fees, consideration or other discounts are payable or have been agreed by SPAC or any of its Affiliates to or with any Forward Purchase Investor in respect of its investment or, except as set forth in the Forward Purchase Agreements.

**Section 4.18 SPAC Related Parties.** Except as disclosed in the SPAC SEC Filings, SPAC has not engaged in any transactions with Related Parties that would be required to be disclosed in the Proxy/Registration Statement.

**Section 4.19 No Outside Reliance.** Notwithstanding anything contained in this Agreement, each of SPAC and its equityholders, partners, members and Representatives, including Sponsor and any of its Affiliates, has made its own investigation of the Company and its Subsidiaries. The SPAC acknowledges and agrees that neither the Company nor any of its Affiliates, agents or Representatives is making any representation or warranty whatsoever, express or implied, beyond those expressly given by the Company in Article III, including any implied warranty or representation as to condition, merchantability, suitability or fitness for a particular purpose or trade as to any of the assets of the Company or any of its Subsidiaries. Without limiting the generality of the foregoing, it is understood that any cost estimates, financial or other projections or other predictions, forecasts or other forward looking information that may be contained or

referred to in the Company Disclosure Letter or elsewhere, as well as any information, documents or other materials (including any such materials contained in any “data room” (whether or not accessed by SPAC or its Representatives) or reviewed by SPAC pursuant to the NDA or otherwise) or management presentations that have been or shall hereafter be provided to SPAC or any of its Affiliates, agents or Representatives or Forward Purchase Investors are not and will not be deemed to be representations or warranties of the Company, any of its Subsidiaries or Company Shareholders, and no representation or warranty is made as to the accuracy or completeness of any of the foregoing except as may be expressly set forth in Article III. Except as otherwise expressly set forth in this Agreement, SPAC understands and agrees that any assets, properties and business of the Company and any of its Subsidiaries are furnished “as is”, “where is” and subject to and except as otherwise provided in the representations and warranties contained in Article III, with all faults and without any other representation or warranty of any nature whatsoever.

## ARTICLE V

### REPRESENTATIONS AND WARRANTIES OF THE MERGER SUBS

Each of the Merger Subs hereby jointly and severally represents and warrants to SPAC and the Company as of the date of this Agreement as follows:

**Section 5.1 Organization, Good Standing, Corporate Power and Qualification.** Each Merger Sub is an exempted company duly incorporated, validly existing and in good standing under the Laws of the Cayman Islands.

#### **Section 5.2 Capitalization and Voting Rights.**

**(a) Capitalization.** As of the date of this Agreement, the authorized share capital of Merger Sub I consists of \$45,500 divided into 455,000,000 shares of \$0.0001 par value each, of which one share (the “*Merger Sub I Share*”) is issued and outstanding, and the authorized share capital of Merger Sub II consists of \$45,500 divided into 455,000,000 shares of \$0.0001 par value each, of which one share (the “*Merger Sub II Share*”) is issued and outstanding (the Merger Sub 1 Share, and the Merger Sub 2 Share, together, the “*Merger Sub Shares*”). The Merger Sub Shares, and any shares of each Merger Sub that will be allotted and issued pursuant to the Transactions, (i) have been, or will be prior to such issuance, duly authorized and have been, or will be at the time of issuance, validly allotted and issued and credited as fully paid, (ii) were, or will be, issued, in compliance with applicable Law and the Organizational Documents of each Merger Sub, and (iii) were not, and will not be, issued in violation of, any Encumbrance, purchase option, call option, pre-emptive right, subscription right or any similar right under any provision of any applicable Law, the Organizational Documents of each Merger Sub, or any other Contract, in any such case to which any Merger Sub is a party or otherwise bound.

**(b) No Other Securities.** Except as set forth in Section 5.2(a) or as contemplated by this Agreement or the other Transaction Documents, there are no issued or outstanding shares of each Merger Sub and there are no outstanding subscriptions, options, warrants, rights or other securities (including debt securities) of each Merger Sub exercisable or exchangeable for shares of the Merger Subs, any other commitments, calls, conversion rights, rights of exchange or privilege (whether pre-emptive, contractual or by matter of Law), plans or other agreements of any character providing for the issuance of additional shares, the sale of treasury shares or of other Equity Securities of the Merger Subs, or for the repurchase or redemption by the Merger Subs of shares or other Equity Securities of the Merger Subs or the value of which is determined by reference to shares or other Equity Securities of the Merger Subs, and there are no voting trusts, proxies or agreements of any kind which may obligate the Merger Subs to issue, purchase, register for sale, redeem or otherwise acquire any shares or other Equity Securities of the Merger Subs.

**(c)** The Merger Subs do not own or control, directly or indirectly, any interest in any corporation, company, partnership, limited liability company, association or other business entity.

**Section 5.3 Corporate Structure; Subsidiaries.** Neither Merger Sub is not obligated to make any investment in or capital contribution to or on behalf of any other Person other than in connection with the Transactions.

**Section 5.4 Authorization.** Each Merger Sub has all requisite corporate power and authority to (i) enter into, execute, deliver and perform its obligations under this Agreement and each of the other Transaction Documents to which it is or will be a party, and (ii) consummate the transactions contemplated hereby and thereby (including the Transactions) and perform all of its obligations hereunder and thereunder. All corporate actions on the part of each Merger Sub necessary for the authorization, execution and delivery of this Agreement and the other Transaction Documents to which each Merger Sub is or will be a party and the performance of all its obligations thereunder (including any board or shareholders' approval, as applicable) have been taken, subject to the filing of the Merger Filing Documents with the Registrar of Companies of the Cayman Islands. This Agreement and the other Transaction Document to which a Merger Sub is or will be a party is, or when executed by the other parties thereto, will constitute, valid and legally binding obligations of such Merger Sub enforceable against it in accordance with its terms, subject to the Enforceability Exceptions.

**Section 5.5 Consents; No Conflicts.** Assuming the representations and warranties in Article III are true and correct, except (a) for the registration or filing with the Registrar of Companies of the Cayman Islands, the SEC or applicable state blue sky or other securities laws filings with respect to the Transactions and (b) for such other filings, notifications, notices, submissions, applications, or consents the failure of which to be obtained or made would not have a material adverse effect on the ability of the Merger Subs to consummate the Transactions, all filings, notifications, notices, submissions, applications, or consents from or with any Governmental Authority or any other Person required in connection with the valid execution, delivery and performance of this Agreement and the other Transaction Documents, and the consummation of the Transactions, in each case on the part of each Merger Sub, have been or will be duly obtained or completed (as applicable) and are or will be in full force and effect. The execution, delivery and performance of this Agreement and the other each Transaction Documents to which a Merger Sub is or will be a party by such Merger Sub does not, and the consummation by such Merger Sub of the transactions contemplated hereby and thereby will not, assuming the representations and warranties in Article III and Article IV are true and correct, and except for the matters referred to in clauses (a) through (b) of the immediately preceding sentence, (a) result in any violation of, be in conflict with, or constitute a default under, require any consent under, or give any Person rights of termination, amendment, acceleration (including acceleration of any obligation of such Merger Sub) or cancellation under, (i) any Governmental Order, (ii) any provision of the Organizational Documents of such Merger Sub, (iii) any applicable Law, (iv) any Contract to which such Merger Sub is a party or by which its assets are bound, or (b) result in the creation of any Encumbrance upon any of the properties or assets of such Merger Sub other than any restrictions under federal or state securities laws, this Agreement or the Organizational Documents of Merger Sub, except in the case of sub-clauses (i), (iii), and (iv) of clause (a) or clause (b) above, as has not had, and would not reasonably be expected to have, individually or in the aggregate, a material adverse effect on the ability of any Merger Sub to consummate the Transactions.

**Section 5.6 Absence of Changes.** Since the date of its incorporation, each Merger Sub has operated its business in the Ordinary Course.

**Section 5.7 Actions.** Except as has not had, and would not reasonably be expected to have, individually or in the aggregate, a material adverse effect on the ability of any Merger Sub to consummate the Transactions, (a) there is no Action pending or threatened in writing against any Merger Sub; and (b) there is no judgment or award unsatisfied against any Merger Sub, nor is there any Governmental Order in effect and binding on any Merger Sub or its assets or properties.

**Section 5.8 Brokers.** Except as set forth in Section 3.17 of the Company Disclosure Letter, no broker, finder or investment banker is entitled to any brokerage, finder's or other fee or commission or expense reimbursement in connection with the Transactions contemplated based upon arrangements made by and on behalf of any Merger Sub or any of its Affiliates.

**Section 5.9 Proxy/Registration Statement.** The information supplied or to be supplied by each Merger Sub or its Representatives in writing specifically for inclusion in the Proxy/Registration Statement shall not, at (a) the time the Proxy/Registration Statement is declared effective, (b) the time the Proxy/Registration Statement (or any amendment thereof or supplement thereto) is first mailed to SPAC Shareholders, and (c) the time of the SPAC Shareholders' Meeting, contain any untrue statement of a material fact or omit to state any material fact required to be stated therein or necessary in order to make the statements therein, in light of the circumstances under which they were made, not misleading. Notwithstanding the foregoing, neither Merger Sub makes any representation, warranty or covenant with respect to any information supplied by or on behalf



of SPAC, its Affiliates or their respective Representatives. All documents that a Merger Sub is responsible for filing with the SEC in connection with the Transactions will comply as to form and substance in all material respects with the applicable requirements of the Securities Act and the Exchange Act.

**Section 5.10 Business Activities.** Each Merger Sub was formed solely for the purpose of effecting the Transactions and has not engaged in any business activities or conducted any operations other than in connection with the Transactions and has no, and at all times prior to the Closing except as expressly contemplated by this Agreement, the Transaction Documents and the Transactions, will have no, assets, liabilities or obligations of any kind or nature whatsoever other than those incident to its formation and the Transactions.

**Section 5.11 Tax Classification.** Merger Sub II has elected to be disregarded as an entity separate from the Company for U.S. federal income tax purposes as of the effective date of its formation and has not subsequently changed such classification. For U.S. federal and applicable state and local income Tax purposes, Merger Sub I is, and has been since its formation, an association taxable as a corporation.

**Section 5.12 No Outside Reliance.** Notwithstanding anything contained in this Agreement, each Merger Sub and any of its equityholders, partners, members or Representatives has made its own investigation of the Company, its Subsidiaries and that neither the Company nor any of its Affiliates, agents or Representatives is making any representation or warranty whatsoever, express or implied, beyond those expressly given by the Company in Article III, including any implied warranty or representation as to condition, merchantability, suitability or fitness for a particular purpose or trade as to any of the assets of the Company or any of its Subsidiaries. Without limiting the generality of the foregoing, it is understood that any cost estimates, financial or other projections or other predictions, forecasts or other forward looking information that may be contained or referred to in the Company Disclosure Letter or elsewhere, as well as any information, documents or other materials (including any such materials contained in any “data room”) (whether or not accessed by such Merger Sub or its Representatives) or management presentations that have been or shall hereafter be provided to such Merger Sub or any of its Affiliates, agents or Representatives or Forward Purchase Investors are not and will not be deemed to be representations or warranties of the Company, any of its Subsidiaries or the Company Shareholders, and no representation or warranty is made as to the accuracy or completeness of any of the foregoing except as may be expressly set forth in Article III. Except as otherwise expressly set forth in this Agreement, such Merger Sub understands and agrees that any assets, properties and business of the Company and any of its Subsidiaries are furnished “as is”, “where is” and subject to and except as otherwise provided in the representations and warranties contained in Article III, with all faults and without any other representation or warranty of any nature whatsoever.

## ARTICLE VI

### COVENANTS OF THE COMPANY AND CERTAIN OTHER PARTIES

**Section 6.1 Conduct of Business.** Except (i) as permitted by the Transaction Documents, (ii) as required by applicable Law (including for this purpose any COVID-19 Measures), (iii) as set forth on Section 6.1 of the Company Disclosure Letter or (iv) as consented to by SPAC in writing (which consent shall not be unreasonably conditioned, withheld, delayed or denied, except with respect to matters set forth in Section 6.1(3)(a) and Section 6.1(3)(c)), from the date of this Agreement through the earlier of the Closing or valid termination of this Agreement pursuant to Article X (the “*Interim Period*”), the Company (1) shall use reasonable efforts to operate the business of the Company and its Subsidiaries in the Ordinary Course, and (2) shall use commercially reasonable efforts to preserve the Group’s business and operational relationships in all material respects with the suppliers, customers and others having business relationships with the Group that are material to the Group taken as a whole, in each case where commercially reasonable to do so, and (3) shall not, and shall cause its Subsidiaries not to, except as otherwise expressly required or permitted by this Agreement under this Section or other applicable Sections or the other Transaction Documents or required by Law, to:

(a) (i) amend its memorandum and articles of association or other Organizational Documents (whether by merger, consolidation, amalgamation or otherwise), except in the case of any of the Company’s Subsidiaries only, for any such amendment which is not material to the business of the Company and its Subsidiaries, taken as a whole; or (ii) liquidate, dissolve, reorganize or otherwise wind-up its business and operations, or propose

or adopt a plan of complete or partial liquidation or dissolution, restructuring, recapitalization, reclassification or similar change in capitalization or other reorganization (other than liquidation or dissolution of any dormant Subsidiary);

**(b)** except in the Ordinary Course, incur, assume, guarantee or repurchase or otherwise become liable for any Indebtedness, or issue or sell any debt securities or options, warrants or other rights to acquire debt securities, in any such case in a principal amount exceeding \$1,000,000, except for borrowings or drawdowns under credit agreements to be entered into and disclosed in Section 6.1(3)(b) of the Company Disclosure Letter or as otherwise required in order to consummate the Transactions;

**(c)** transfer, issue, sell, grant, pledge or otherwise dispose of (i) any of the Equity Securities of the Company or any of its Subsidiaries to a third party, or (ii) any options, warrants, rights of conversion or other rights, agreements, arrangements or commitment obligations of the Company or any of its Subsidiaries to purchase or obtain any Equity Securities of the Company or any of its Subsidiaries to a third party, other than (A) Company Ordinary Shares upon conversion of Company Preferred Shares in accordance with the Company Charter, (B) issuance of Equity Securities by a Subsidiary of the Company (x) to the Company or a wholly-owned Subsidiary of the Company or (y) on a pro rata basis to all shareholders of such Subsidiary; (C) any Equity Securities of a Subsidiary of the Company pursuant to a transaction permitted under Section 6.1(3)(d); and (D) any Equity Securities of the Company for the Permitted Equity Financing Proceeds;

**(d)** sell, lease, sublease, license, transfer, abandon, allow to lapse or dispose of any material property or assets (other than Intellectual Property), in any single transaction or series of related transactions, except for (i) transactions pursuant to Contracts entered into in the Ordinary Course, (ii) (other than transactions involving the exclusive license of any material property or assets) transactions that do not exceed \$1,000,000 individually and \$2,000,000 in the aggregate, or (iii) dispositions of obsolete, surplus or worn out assets that are no longer useful in the conduct of the business of the Company or its Subsidiaries in the Ordinary Course;

**(e)** sell, assign, transfer, lease, license or sublicense, abandon, permit to lapse or otherwise dispose of or impose any Encumbrance (other than Permitted Encumbrances) (except with respect to clause (f) in the definition of Permitted Encumbrances) upon any material Owned IP, in each case, except for non-exclusive licenses or non-material exclusive licenses under material Owned IP granted in the Ordinary Course;

**(f)** disclose any trade secrets or material confidential information;

**(g)** make any acquisition of, or investment in, a business, by purchase of stock, securities or assets, merger or consolidation, or contributions to capital, or loans or advances, except, in any such case and subject always to Section 6.1(3)(a), Section 6.1(3)(c) and Section 6.1(3)(i), with a value or purchase price in excess of \$1,000,000 individually and \$2,000,000 in the aggregate;

**(h)** settle any Action by any Governmental Authority or any other third party material to the business of the Company and its Subsidiaries taken as a whole, in excess of \$1,000,000 individually and \$2,000,000 in the aggregate;

**(i)** (i) split, combine, subdivide, reclassify, or amend any terms of its Equity Securities, except for any such transaction by a wholly-owned Subsidiary of the Company that remains a wholly-owned Subsidiary of the Company after consummation of such transaction, (ii) redeem, repurchase, cancel or otherwise acquire or offer to redeem, repurchase, or otherwise acquire any of its Equity Securities, except for the redemption of Equity Securities issued under the ESOP or as disclosed in Section 6.1(3)(i) of the Company Disclosure Letter, (iii) declare, set aside, establish a record date for, make or pay any dividend or other distribution, payable in cash, shares, property or otherwise, with respect to any of its share capital other than dividends or distributions by any Subsidiary of the Company on a pro rata basis to its shareholders, or (iv) amend any term or alter any rights of any of its outstanding Equity Securities;

**(j)** except in the Ordinary Course, authorize, make or incur any capital expenditures or obligations or liabilities in connection therewith, other than any capital expenditures or obligations or liabilities in an amount not to exceed \$2,000,000 in the aggregate;

**(k)** (i) except in the Ordinary Course, accelerate or delay in any respect material to the Company and its Subsidiaries, taken as a whole (A) collection of any account receivable in advance of or beyond its due date, or

(B) payment of any account payable in advance of or beyond its due date; or (ii) conduct its cash management customs and practices (including the collection of receivables, the payment of payables and any other movement of cash, cash equivalents or marketable securities) other than in the Ordinary Course;

(l) except in the Ordinary Course or as disclosed in Section 6.1(3)(l) of the Company Disclosure Letter, (i) enter into any Material Contract, (ii) amend any such Material Contract or extend, transfer, terminate or waive any right or entitlement of material value under any Material Contract, in a manner that is adverse to the Company and its Subsidiaries, taken as a whole, other than in any immaterial respect;

(m) voluntarily terminate (other than expiration in accordance with its terms), suspend, abrogate, amend or modify any Material Permit except in the Ordinary Course or as would not be material to the business of the Company and its Subsidiaries, taken as a whole;

(n) make any material change in its accounting principles or methods unless required by GAAP or applicable Laws;

(o) except in the Ordinary Course, (i) make, change, or revoke any election in respect of material Taxes, (ii) adopt or change any material Tax accounting method, (iii) file any material amended Tax Return, (iv) enter into any material Tax “closing agreement” within the meaning of Section 7121 of the Code (or any similar provision of state, local, or non-U.S. Law) with any Governmental Authority, (v) settle any income or other material Tax claim or assessment, (vi) surrender any right to claim a refund of material Taxes, (vii) consent to any extension or waiver of the limitation period applicable to or relating to any material Tax claim or assessment, or (viii) knowingly fail to pay any material Tax that becomes due and payable (including estimated Tax payments) (other than Taxes being contested in good faith and for which adequate reserves have been established in the Audited Financial Statements in accordance with GAAP);

(p) (w) increase the compensation or benefits payable or provided, or to become payable or provided to, any Key Officer or any current or former directors, officers or individual service providers of the Company or any of its Subsidiaries whose total annual compensation opportunity exceeds \$200,000, except for bonuses, base salary increases or in connection with any promotions in the Ordinary Course not exceeding \$200,000 on an individual basis, (x) except in the Ordinary Course, grant or announce any cash or equity or equity-based incentive awards, bonuses, transaction, retention, severance or other additional compensation or benefits to any Key Officer or any current or former directors, officers or individual service providers of the Company or any of its Subsidiaries, (y) accelerate the time of payment, vesting or funding of any compensation or increase in the benefits or compensation provided under any Benefit Plan or otherwise due to any Key Officer or any current or former directors, officers or individual service providers of the Company or any of its Subsidiaries, or (z) hire, engage, terminate (other than for “cause”), furlough or temporary layoff any employee of the Company or any of its Subsidiaries whose total annual compensation exceeds \$500,000;

(q) except as required by any Benefit Plan as in effect on the date of this Agreement and set forth in Section 3.16(a) of the Company Disclosure Letter, or as otherwise required by Law, amend, modify, or terminate any Benefit Plan or adopt or establish a new Benefit Plan (or any plan, program, agreement or other arrangement that would be a Benefit Plan if in effect as of the date of this Agreement);

(r) waive or release any non-competition or non-solicitation obligation of any current or former directors, officers or individual service providers (whose total annual compensation exceeds \$200,000) of the Company or any of its Subsidiaries; or

(s) enter into any agreement or otherwise make a commitment to do any of the foregoing (except to the extent that such an agreement or commitment would be permitted by a subsection of the foregoing subsections (a) through (r)).

For the avoidance of doubt, if any action taken or refrained from being taken by the Company or a Subsidiary is covered by a subsection of this Section 6.1 and not prohibited thereunder, the taking or not taking of such action shall be deemed not to be in violation of any other part of this Section 6.1.

**Section 6.2 Access to Information.** Upon reasonable prior notice and subject to applicable Law, from the date of this Agreement until the Second Merger Effective Time, the Company shall, and shall cause each of its Subsidiaries and each of its and its Subsidiaries’ officers, directors and employees to, and shall use its

commercially reasonable efforts to cause its Representatives to, afford SPAC and its officers, directors, employees and Representatives, following reasonable notice from SPAC in accordance with this Section 6.2, reasonable access during normal business hours to the officers, directors, employees, agents, Representatives, properties, offices and other facilities, books and records of each of it and its Subsidiaries, and all other financial, operating and other data and information as shall be reasonably requested; *provided, however*, that in each case, the Company and its Subsidiaries shall not be required to disclose any document or information, or permit any inspection, that would, in the reasonable judgment of the Company, (a) result in the disclosure of any trade secrets or violate the terms of any confidentiality provisions in any agreement with a third party, (b) result in a violation of applicable Law, including any fiduciary duty, (c) waive the protection of any attorney-client work product or other applicable privilege or (d) result in the disclosure of any sensitive or personal information that would expose the Company to the risk of Liabilities. All information and materials provided pursuant to this Agreement will be subject to the provisions of the NDA.

**Section 6.3 Acquisition Proposals and Alternative Transactions.** During the Interim Period, the Company shall not, and it shall cause its Controlled Affiliates and its and their respective Representatives not to, directly or indirectly: (a) solicit, initiate, submit, facilitate (including by means of furnishing or disclosing information), discuss or negotiate, directly or indirectly, any inquiry, proposal or offer (written or oral) with any third-party (including any Competing SPAC) with respect to a Company Acquisition Proposal; (b) furnish or disclose any non-public information to any third-party (including to any Competing SPAC) in connection with or that would reasonably be expected to lead to a Company Acquisition Proposal; (c) enter into any agreement, arrangement or understanding with any third party (including a Competing SPAC) regarding a Company Acquisition Proposal; (d) prepare or take any steps in connection with a public offering of any Equity Securities of the Company, any of its Subsidiaries, or a newly-formed holding company of the Company or such Subsidiaries or (e) otherwise cooperate in any way with, or assist or participate in, or knowingly facilitate or encourage any effort or attempt by any Person to do or seek to do any of the foregoing.

**Section 6.4 D&O Indemnification and Insurance.**

(a) From and after the Closing, the Surviving Company and the Company shall jointly and severally indemnify and hold harmless each present and former director and officer of the Company and SPAC (in each case, solely to the extent acting in his or her capacity as such and to the extent such activities are related to the business of the Company or SPAC, respectively) (the “*D&O Indemnified Parties*”) against any costs or expenses (including reasonable attorneys’ fees), judgments, fines, losses, claims, damages or liabilities incurred in connection with any Action, to the fullest extent permitted under applicable Law and as set forth under the Organizational Documents or indemnification agreements of the Company or SPAC, respectively, in each case, in effect on the date of this Agreement, **provided that** the Company shall not be liable to any D&O Indemnified Party for any costs or expenses (including reasonable attorneys’ fees), judgments, fines, losses, claims, damages or liabilities incurred as a result of actual fraud or willful default by such D&O Indemnified Party if a court of competent jurisdiction shall have made a final judgment to that effect. Without limiting the foregoing, the Surviving Company and the Company shall (i) maintain for a period of not less than six years from the Closing, provisions in its certificate of incorporation, certificate of formation, bylaws, memorandum and articles of association, limited liability company agreement, limited liability partnership agreement, limited liability limited partnership agreement and other Organizational Documents concerning the indemnification and exoneration (including provisions relating to expense advancement) of the Company’s or SPAC’s, respectively, former and current officers, directors, employees, and agents that are no less favorable to those Persons than the provisions of the certificate of incorporation, certificate of formation, bylaws, memorandum and articles of association, limited liability company agreement, operating agreement, limited liability partnership agreement, limited liability limited partnership agreement and other Organizational Documents of the Company or SPAC, respectively, in each case, as of the date of this Agreement and (ii) not amend, repeal or otherwise modify such provisions in any respect that would materially and adversely affect the rights of those Persons thereunder, in each case, except as required by Law.

(b) For a period of six years from the Closing, each of the Company and the Surviving Company shall maintain in effect directors’ and officers’ liability insurance (each a “*D&O Insurance*”) covering directors and officers of the Company and those Persons who are currently covered by the SPAC’s directors’ and officers’ liability insurance policies (including, in any event, the D&O Indemnified Parties) on terms not less favorable than the terms of such current insurance coverage and with insurance carriers with the same or better credit

rating, except that in no event shall the Company or the Surviving Company be required to pay an annual premium for such insurance in excess of 300% of the aggregate annual premium payable by the Company or SPAC, respectively, for such insurance policy for the year ended March 31, 2022 (in the case of the Company) or December 31, 2021 (in the case of SPAC), as the case may be (“*Maximum Annual Premium*”); **provided, however**, that (i) each of the Company and the Surviving Company may cause coverage to be extended under the current directors’ and officers’ liability insurance by obtaining a six-year “tail” policy (each a “*D&O Tail*”) with respect to claims existing or wrongful acts occurring at or prior to the Closing and if and to the extent such policies have been obtained prior to the Closing with respect to any such Persons, the Surviving Company and the Company, respectively, shall maintain such policies in effect and continue to honor the obligations thereunder, and (ii) if any claim is asserted or made within such six-year period, any insurance required to be maintained under this Section 6.4 shall be continued in respect of such claim until the final disposition thereof. If the Company or Surviving Company is unable to obtain the policies for an amount less than or equal to the Maximum Annual Premium, the Company or Surviving Company will instead obtain as much comparable insurance as possible for an annual premium equal to the Maximum Annual Premium. The costs of any D&O Insurance for the period after the Closing Date, and the cost of any D&O Tail to the extent in effect following the Closing Date, shall be borne by the Company and shall not be a SPAC Transaction Expense.

(c) Notwithstanding anything contained in this Agreement to the contrary, this Section 6.4 shall survive the Closing indefinitely and shall be binding, jointly and severally, on the Surviving Company and the Company and all of their respective successors and assigns. In the event that the Surviving Company, the Company or any of their respective successors or assigns consolidates with or merges into any other Person and shall not be the continuing or surviving company or entity of such consolidation or merger or transfers or conveys all or substantially all of its properties and assets to any Person, then, and in each such case, the Surviving Company or the Company, respectively, shall ensure that proper provision shall be made so that the successors and assigns of the Surviving Company or the Company, as the case may be, shall succeed to the obligations set forth in this Section 6.4.

(d) The provisions of Section 6.4(a) through (c): (i) are intended to be for the benefit of, and shall be enforceable by, each Person who is now, or who has been at any time prior to the date of this Agreement or who becomes prior to the Closing, a D&O Indemnified Party, his or her heirs and his or her personal representatives, (ii) shall be binding on the Surviving Company and the Company and their respective successors and assigns, (iii) are in addition to, and not in substitution for, any other rights to indemnification or contribution that any such Person may have, whether pursuant to Law, Contract, Organizational Documents, or otherwise and (iv) shall survive the consummation of the Closing and shall not be terminated or modified in such a manner as to adversely affect any D&O Indemnified Party without the consent of such D&O Indemnified Party.

**Section 6.5 Notice of Developments.** From and after the date of this Agreement until the earlier of the Closing or the termination of this Agreement in accordance with its terms, the Company and each Merger Sub shall promptly (and in any event prior to the Closing) notify SPAC in writing, and SPAC shall promptly (and in any event prior to the Closing) notify the Company and each Merger Sub in writing, upon any of the Group Companies, the Merger Subs or SPAC, as applicable, becoming aware (awareness being determined with reference to the Knowledge of the Company or the Knowledge of SPAC, as the case may be): (i) of the occurrence or non-occurrence of any event the occurrence or non-occurrence of which has caused or is reasonably likely to cause any condition to the obligations of any party to effect the Transactions not to be satisfied or (ii) of any notice or other communication from any Governmental Authority which is reasonably likely to have a material adverse effect on the ability of the parties hereto to consummate the Transactions or to materially delay the timing thereof. The delivery of any notice pursuant to this Section 6.5 shall not cure any breach of any representation or warranty requiring disclosure of such matter or any breach of any covenant, condition or agreement contained in this Agreement or any other Transaction Document or otherwise limit or affect the rights of, or the remedies available to, SPAC or the Company, as applicable. Notwithstanding anything to the contrary contained herein, any failure to give such notice pursuant to this Section 6.5 shall not give rise to any liability of the Company or SPAC or be taken into account in determining whether the conditions in Article IX have been satisfied or give rise to any right of termination set forth in Article X.

### Section 6.6 Financials.

(a) If the Closing has not occurred prior to December 31, 2022, as soon as reasonably practicable following December 31, 2022, the Company shall deliver to SPAC and the Company, the unaudited consolidated balance sheet of the Company and its Subsidiaries as of September 30, 2022, and the related unaudited consolidated statements of income and profit and loss, and cash flows for the six-month period then ended, which comply with the applicable accounting requirements and with the rules and regulations of the SEC, the Exchange Act and the Securities Act applicable to a registrant, in effect as of the respective dates thereof (the “*Interim Financial Statements*”). Upon delivery of the Interim Financial Statements, the representations and warranties set forth in Section 3.9 shall be deemed to apply to the Interim Financial Statements in the same manner as the Audited Financial Statements, *mutatis mutandis*, with the same force and effect as if included in Section 3.9 as of the date of this Agreement.

(b) The Company and SPAC shall each use its reasonable efforts (a) to assist the other, upon advance written notice, during normal business hours and in a manner such as to not unreasonably interfere with the normal operation of the Company, any of its Subsidiaries or SPAC, in preparing in a timely manner any other financial information or statements (including customary pro forma financial statements) that are required to be included in the Proxy/Registration Statement and any other filings to be made by SPAC or the Company with the SEC in connection with the Transactions and (b) to obtain the consents of its auditors with respect thereto as may be required by applicable Law or requested by the SEC in connection therewith.

**Section 6.7 No Trading.** The Company acknowledges and agrees that it is aware, and that its Controlled Affiliates have been made aware of the restrictions imposed by U.S. federal securities laws and the rules and regulations of the SEC promulgated thereunder or otherwise and other applicable foreign and domestic Laws on a Person possessing material nonpublic information about a publicly traded company. The Company hereby agrees that it shall not purchase or sell any securities of SPAC in violation of such Laws, or cause or encourage any Person to do the foregoing.

**Section 6.8 Nasdaq Listing.** The Company will use its commercially reasonable efforts to: (i) submit an initial listing application to the Nasdaq in connection with the Transactions to be approved; (ii) satisfy all applicable initial listing standards and requirements of the Nasdaq and obtain Nasdaq’s approval of its initial listing application; and (iii) cause the Registrable Securities to be approved for listing on the Nasdaq and accepted for clearance by DTC (and SPAC shall reasonably cooperate in connection therewith), subject to official notice of issuance, in each case, as promptly as reasonably practicable after the date of this Agreement, and in any event prior to the First Merger Effective Time.

**Section 6.9 Company Incentive Plan.** Prior to the Closing Date, the Company shall have approved and adopted a share incentive plan in substantially the form attached hereto as Exhibit F (the “*Amended Company Incentive Plan*”) to amend and restate the ESOP in its entirety such that the maximum number of Company Ordinary Shares that may be issued thereunder after the Closing reflects the Company Capital Restructuring.

**Section 6.10 Post-Closing Directors and Officers of the Company.** Subject to the terms of the Amended Company Charter, the Company shall take all such action within its power as may be necessary or appropriate such that immediately following the Closing:

(a) the board of directors of the Company (i) shall have been reconstituted to consist of no less than seven (7) directors, of which (A) the majority shall be such Persons as the Company may designate sufficiently in advance to allow for inclusion of such Persons in the Proxy/Registration Statement and (B) the Sponsor may designate no more than two Persons pursuant to a written notice to be delivered to the Company sufficiently in advance to allow for inclusion of such Persons in the Proxy/Registration Statement and (ii) shall have reconstituted its applicable committees to consist of the directors designated by the Company prior to the Closing Date; **provided, however**, that the directors designated by the Company in accordance with clause (ii) of this sentence shall satisfy the independence requirements and other qualifications for the applicable committees as required by applicable Laws or under the Nasdaq listing rules;

(b) the Chairperson of the board of directors of the Company shall initially be Mr. Yi Zhang; and

(c) the officers of the Company holding such positions as set forth on Schedule III shall be the officers of the Company, each such officer to hold office in accordance with the Amended Company Charter until

they are removed or resign in accordance with the Amended Company Charter or until their respective successors are duly elected or appointed and qualified.

**Section 6.11 Public Filings.** From the date of this Agreement through the Closing, the Company will use reasonable best efforts to accurately and timely file all reports required to be filed or furnished with the SEC and otherwise comply in all material respects with its reporting obligations under applicable Laws.

**Section 6.12 Change of Name.** From the date of this Agreement through the Closing, the Company will use reasonable best efforts to change its name from YishengBio Co., Ltd. to YS Biopharma Co., Ltd., effective prior to the First Merger Effective Time.

## ARTICLE VII

### COVENANTS OF SPAC AND THE MERGER SUBS

**Section 7.1 Nasdaq Listing.** From the date of this Agreement through the Closing, SPAC shall use reasonable best efforts to ensure SPAC remains listed as a public company on Nasdaq and to continue the listing of the SPAC Class A Ordinary Shares, the SPAC Warrants and the SPAC Units on the Nasdaq. Prior to the Closing Date, SPAC shall cooperate with the Company and use reasonable best efforts to take such actions as are reasonably necessary or advisable to cause the SPAC Class A Ordinary Shares, SPAC Warrants and SPAC Units to be delisted from the Nasdaq and deregistered under the Exchange Act as soon as practicable following the First Merger Effective Time.

**Section 7.2 Conduct of Business.** Except (i) as contemplated or permitted by the Transaction Documents, (ii) as required by applicable Law (including for this purpose any COVID-19 Measures), or (iii) as consented to by the Company in writing (which consent with respect to the matters set forth in sub-clauses (f) and (h) below shall not be unreasonably withheld, conditioned or delayed), during the Interim Period, each of SPAC and the Merger Subs (1) shall operate its business in the Ordinary Course and (2) shall not:

(a) (i) with respect to SPAC only, seek any approval from SPAC Shareholders to change, modify or amend the Trust Agreement or the SPAC Charter or other Organizational Documents, except as contemplated by the Transaction Proposals or (ii) change, modify or amend the Trust Agreement or its Organizational Documents (including but not limited to entering into any settlement, conciliation or similar Contract that would require any payment from the Trust Account), except as expressly contemplated by the Transaction Proposals;

(b) (i) declare, set aside, establish a record date for, make or pay any dividend or other distribution, payable in cash, shares, property or otherwise, with respect to any of its share capital, (ii) split, combine, subdivide, reclassify or amend any terms of its Equity Securities or (iii) redeem, repurchase, cancel or otherwise acquire or offer to redeem, repurchase, or otherwise acquire any of its Equity Securities, other than a redemption of SPAC Class A Ordinary Shares in connection with the exercise of any SPAC Shareholder Redemption Right by any SPAC Shareholder or upon conversion of SPAC Class B Ordinary Shares in accordance with the SPAC Charter;

(c) merge, consolidate or amalgamate with or into, or acquire (by purchasing a substantial portion of the assets of or any equity in, or by any other manner) or make any advance or loan to or investment in any other Person or be acquired by any other Person;

(d) except in the Ordinary Course, (i) make, change, or revoke any election in respect of material Taxes, (ii) adopt or change any material Tax accounting method, (iii) file any material amended Tax Return, (iv) enter into any material Tax “closing agreement” within the meaning of Section 7121 of the Code (or any similar provision of state, local, or non-U.S. Law) with any Governmental Authority, (v) settle any income or other material Tax claim or assessment, (vi) surrender any right to claim a refund of material Taxes, (vii) consent to any extension or waiver of the limitation period applicable to or relating to any material Tax claim or assessment, or (viii) knowingly fail to pay any material Tax that becomes due and payable (including estimated Tax payments) (other than Taxes being contested in good faith and for which adequate reserves have been established in the SPAC Financial Statements in accordance with GAAP);

(e) (i) enter into, renew or amend in any material respect, any transaction or material Contract, except for material Contracts entered into in the Ordinary Course, (ii) extend, transfer, terminate or waive any right or entitlement of material value under any material Contract, in a manner that is materially adverse to the SPAC, (iii) enter into any settlement, conciliation or similar Contract that would impose non-monetary obligations of SPAC or any of its Affiliates (or the Company or any of its Subsidiaries after the Closing); **provided, however**, that notwithstanding anything to the contrary contained in this Agreement, even if done in the Ordinary Course, SPAC shall not enter into, renew or amend in any respect, any transaction or Contract involving an Affiliate or Related Party of SPAC, Sponsor or any Affiliate of Sponsor, except as expressly provided in the Transaction Documents or relating to any Working Capital Loan;

(f) incur, assume, guarantee or repurchase or otherwise become liable for any Indebtedness, or issue or sell any debt securities or options, warrants, rights or conversion or other rights to acquire debt securities, or other material Liability, or make any capital expenditures, in any case in a principal amount or amount, as applicable, exceeding \$750,000 individually or in the aggregate, other than Indebtedness or other Liabilities expressly set out in Section 4.15(d) of the SPAC Disclosure Letter.

(g) make any change in its accounting principles or methods unless required by GAAP or applicable Laws;

(h) (i) issue any Equity Securities, other than the issuance of Equity Securities of SPAC pursuant to the Forward Purchase Agreements or this Agreement, or the issuance of SPAC Class A Ordinary Shares upon conversion of SPAC Class B Ordinary Shares in accordance with the SPAC Charter or (ii) grant any options, warrants, rights of conversion or other equity-based awards;

(i) settle or agree to settle any Action before any Governmental Authority or any other third party or that imposes injunctive or other non-monetary relief on SPAC or any Merger Sub;

(j) form any Subsidiary;

(k) liquidate, dissolve, reorganize or otherwise wind-up the business and operations of SPAC or propose or adopt a plan of complete or partial liquidation or dissolution, consolidation, restructuring, recapitalization, reclassification or similar change in capitalization or other reorganization of SPAC; or

(l) enter into any agreement or otherwise make any commitment to do any action prohibited under this Section 7.2;

**provided, however**, that during the period from the First Merger Effective Time through the Second Merger Effective Time, the Surviving Entity and Merger Sub II shall not take any action except as required or contemplated by this Agreement or the other Transaction Documents.

**Section 7.3 Acquisition Proposals and Alternative Transactions.** During the Interim Period, SPAC will not, and it will cause its Affiliates and its and their respective Representatives not to, directly or indirectly: (a) solicit, initiate, submit, facilitate (including by means of furnishing or disclosing information), discuss or negotiate, directly or indirectly, any inquiry, proposal or offer (written or oral) with respect to a SPAC Acquisition Proposal; (b) furnish or disclose any non-public information to any person or entity in connection with or that could reasonably be expected to lead to a SPAC Acquisition Proposal; (c) enter into any agreement, arrangement or understanding regarding a SPAC Acquisition Proposal; or (d) otherwise cooperate in any way with, or assist or participate in, or knowingly facilitate or encourage any effort or attempt by any Person to do or seek to do any of the foregoing.

**Section 7.4 Public Filings of SPAC.** From the date of this Agreement through the Closing, each of SPAC and the Company will use reasonable best efforts to keep current and accurately and timely file all reports required to be filed or furnished with the SEC and otherwise comply in all material respects with its reporting obligations under applicable Laws. As promptly as practicable after execution of this Agreement, SPAC will prepare and file a Current Report on Form 8-K pursuant to the Exchange Act to report the execution of this Agreement, the form and substance of which has been approved by the Company.

**Section 7.5 Access to Information.** Upon reasonable prior notice and subject to applicable Law, from the date of this Agreement until the Second Merger Effective Time, SPAC shall, and shall cause each of its officers, directors and employees to, and shall use its commercially reasonable efforts to cause its



Representatives to, afford the Company and its officers, directors, employees and Representatives, following reasonable notice from the Company in accordance with this Section 7.5, reasonable access during normal business hours to its officers, directors, employees, agents, Representatives, properties, offices and other facilities, books and records, and all other financial, operating and other data and information as shall be reasonably requested; *provided, however*, that in each case, SPAC shall not be required to disclose any document or information, or permit any inspection, that would, in the reasonable judgment of SPAC, (a) result in the disclosure of any trade secrets or violate the terms of any confidentiality provisions in any agreement with a third party, (b) result in a violation of applicable Law, including any fiduciary duty, (c) waive the protection of any attorney-client work product or other applicable privilege or (d) result in the disclosure of any sensitive or personal information that would expose SPAC to the risk of Liabilities. All information and materials provided pursuant to this Agreement will be subject to the provisions of the NDA.

## ARTICLE VIII

### JOINT COVENANTS

#### Section 8.1 Regulatory Approvals; Other Filings.

(a) Each of the Company, SPAC and the Merger Subs shall use their commercially reasonable efforts to cooperate in good faith with any Governmental Authority and to undertake promptly any and all action required to obtain any necessary or advisable regulatory approvals, consents, Actions, nonactions or waivers in connection with the Transactions (the “*Regulatory Approvals*”) as soon as practicable and any and all action necessary to consummate the Transactions as contemplated hereby. Each of the Company, SPAC and the Merger Subs shall use commercially reasonable efforts to cause the expiration or termination of the waiting, notice or review periods under any applicable Regulatory Approval with respect to the Transactions as promptly as possible after the execution of this Agreement.

(b) With respect to each of the Regulatory Approvals and any other requests, inquiries, Actions or other proceedings by or from Governmental Authorities, each of the Company, SPAC and the Merger Subs shall (i) diligently and expeditiously defend and use commercially reasonable efforts to obtain any necessary clearance, approval, consent or Regulatory Approval under any applicable Laws prescribed or enforceable by any Governmental Authority for the Transactions and to resolve any objections as may be asserted by any Governmental Authority with respect to the Transactions; and (ii) cooperate fully with each other in the defense of such matters. To the extent not prohibited by Law, the Company shall promptly furnish to SPAC, and SPAC and the Merger Subs shall promptly furnish to the Company, copies of any material, substantive notices or written communications received by such party or any of its Affiliates from any Governmental Authority with respect to the Transactions, and each such party shall permit counsel to the other parties an opportunity to review in advance, and each such party shall consider in good faith the views of such counsel in connection with, any proposed material, substantive written communications by such party or its Affiliates to any Governmental Authority concerning the Transactions; *provided, however*, that none of SPAC, the Company or the Merger Subs shall enter into any agreement with any Governmental Authority relating to any Regulatory Approval contemplated in this Agreement without the prior written consent of the Company; *provided, further*, that none of the Company and the Merger Subs shall enter into any agreement with any Governmental Authority with respect to the Transactions which (i) as a result of its terms materially delays the consummation of, or prohibits, the Transactions or (ii) adds any condition to the consummation of the Transactions, in any such case, unless otherwise required by applicable Law or without the prior written consent of SPAC. To the extent not prohibited by Law, the Company and the Merger Subs agree to provide SPAC and its counsel, and SPAC agrees to provide to the Company and its counsel, the opportunity, to the extent practical, on reasonable advance notice, to participate in any material substantive meetings or discussions, either in person or by telephone, between such party or any of its Affiliates or Representatives, on the one hand, and any Governmental Authority, on the other hand, concerning or in connection with the Transactions. Each of the Company, SPAC and the Merger Subs agrees to make all filings, to provide all information required of such party and to reasonably cooperate with each other, in each case, in connection with the Regulatory Approvals; *provided, further*, that such party shall not be required to provide information to the extent that (w) any applicable Law requires it or its Affiliates to restrict or prohibit access to such information, (x) in the reasonable judgment of such party, the information is subject to confidentiality obligations to a third party, (y) in the reasonable judgment of such party, the information is commercially

sensitive and disclosure of such information would have a material impact on the business, results of operations or financial condition of such party, or (z) disclosure of any such information would reasonably be likely to result in the loss or waiver of the attorney-client, work product or other applicable privilege.

## **Section 8.2 Preparation of Proxy/Registration Statement; SPAC Shareholders' Meeting and Approvals.**

### **(a) Proxy/Registration Statement.**

(i) As promptly as reasonably practicable after the execution of this Agreement, SPAC, the Merger Subs and the Company shall prepare, and the Company shall file with the SEC, the Registration Statement (as amended or supplemented from time to time, and including the Proxy Statement, the "**Proxy/Registration Statement**") relating to (x) the SPAC Shareholders' Meeting to approve and adopt the Transaction Proposals and (y) the registration under the Securities Act of the Registrable Securities. SPAC, the Merger Subs and the Company each shall use their commercially reasonable efforts to (1) cause the Proxy/Registration Statement when filed with the SEC to comply in all material respects with all Laws applicable thereto and rules and regulations promulgated by the SEC, (2) respond as promptly as reasonably practicable to and resolve all comments received from the SEC concerning the Proxy/Registration Statement, (3) cause the Proxy/Registration Statement to be declared effective under the Securities Act as promptly as practicable and (4) keep the Proxy/Registration Statement effective as long as is necessary to consummate the Transactions. Prior to the effective date of the Proxy/Registration Statement, the Company, SPAC and the Company shall take all or any action required under any applicable federal or state securities Laws in connection with the issuance of Company Ordinary Shares and Company Warrants pursuant to this Agreement. Each of the Company, SPAC and the Merger Subs also agrees to use its commercially reasonable efforts to obtain all necessary state securities law or "**Blue Sky**" permits and approvals required to carry out the Transactions, and the Company and SPAC shall furnish all information, respectively, concerning SPAC and the Company, its Subsidiaries and any of their respective members or shareholders as may be reasonably requested in connection with any such action. As promptly as practicable after finalization and effectiveness of the Proxy/Registration Statement, SPAC shall, and shall use commercially reasonable efforts to, within ten (10) Business Days of such finalization and effectiveness, mail the Proxy/Registration Statement to the SPAC Shareholders. Notwithstanding anything to the contrary contained in this Agreement, nothing contained in this Agreement shall require counsel to SPAC, counsel to the Company, or any Tax advisors of SPAC or the Company to provide any Tax opinion in connection with the Proxy/Registration Statement that the Mergers qualify for nonrecognition treatment, in whole or in part, under the Code or any state, local, or non-U.S. Law. Each of SPAC, the Merger Subs and the Company shall furnish to the other parties all information concerning itself, its Subsidiaries, officers, directors, managers, shareholders, and other equityholders and information regarding such other matters as may be reasonably necessary or advisable or as may be reasonably requested by any of them or any Governmental Authority in connection with the Proxy/Registration Statement, or any other statement, filing, notice or application made by or on behalf of SPAC, the Merger Subs, the Company or their respective Affiliates to any Governmental Authority (including Nasdaq) in connection with the Transactions. Subject to Section 11.6, the Company, on the one hand, and SPAC, on the other, shall each be responsible for and pay one-half of the cost for the preparation, filing and mailing of the Proxy/Registration Statement and other related fees.

(ii) Any filing of, or amendment or supplement to, the Proxy/Registration Statement will be mutually prepared and agreed upon by SPAC and the Company. The Company will advise SPAC, promptly after receiving notice thereof, of the time when the Proxy/Registration Statement has become effective or any supplement or amendment has been filed, of the issuance of any stop order, of the suspension of the qualification of Company Ordinary Shares and Company Warrants to be issued or issuable in connection with this Agreement for offering or sale in any jurisdiction, or of any request by the SEC for amendment of the Proxy/Registration Statement or comments thereon and responses thereto or requests by the SEC for additional information and responses thereto, and shall provide the Company and SPAC a reasonable opportunity to provide comments and amendments to any such filing. SPAC and the Company shall cooperate and mutually agree upon (such agreement not to be unreasonably withheld or delayed), any response to comments of the SEC or its staff with respect to the Proxy/Registration Statement and any amendment to the Proxy/Registration Statement filed in response thereto.

(iii) If, at any time prior to the First Merger Effective Time, any event or circumstance relating to SPAC or its officers or directors, should be discovered by SPAC which should be set forth in an amendment or a supplement to the Proxy/Registration Statement, SPAC shall promptly inform the Company. If, at any time prior to the First Merger Effective Time, any event or circumstance relating to the Company, any of its Subsidiaries (including the Merger Subs) or their respective officers or directors, should be discovered by the Company which should be set forth in an amendment or a supplement to the Proxy/Registration Statement, the Company shall promptly inform SPAC. Thereafter, SPAC, the Merger Subs and the Company shall promptly cooperate in the preparation and filing of an appropriate amendment or supplement to the Proxy/Registration Statement describing or correcting such information, and SPAC and the Company shall promptly file such amendment or supplement with the SEC and, to the extent required by Law, disseminate such amendment or supplement to the SPAC Shareholders.

(b) SPAC Shareholders' Approval.

(i) Prior to or as promptly as practicable after the Proxy/Registration Statement is declared effective under the Securities Act, SPAC shall establish a record date for, duly call, give notice of, convene and hold a meeting of the SPAC Shareholders (including any adjournment or postponement thereof, the "**SPAC Shareholders' Meeting**") in accordance with the SPAC Charter to be held as promptly as reasonably practicable and, unless otherwise agreed by SPAC and the Company in writing, in any event not more than thirty (30) days following the date that the Proxy/Registration Statement is declared effective under the Securities Act for the purpose of voting on the Transaction Proposals and obtaining the SPAC Shareholders' Approval (including the approval of any adjournment or postponement of such meeting for the purpose of soliciting additional proxies in favor of the adoption of the Transaction Proposals), providing SPAC Shareholders with the opportunity to elect to exercise their SPAC Shareholder Redemption Right and such other matters as may be mutually agreed by SPAC and the Company. SPAC will use its reasonable best efforts (A) to solicit from its shareholders proxies in favor of the adoption of the Transaction Proposals, including the SPAC Shareholders' Approval, and will take all other action necessary or advisable to obtain such proxies and SPAC Shareholders' Approval and (B) to obtain the vote or consent of its shareholders required by and in compliance with all applicable Law, Nasdaq rules and the SPAC Charter. SPAC (x) shall consult with the Company regarding the record date and the date of the SPAC Shareholders' Meeting prior to determining such dates and (y) shall not adjourn or postpone the SPAC Shareholders' Meeting without the prior written consent of Company (which consent shall not be unreasonably withheld, conditioned or delayed); **provided, however**, that SPAC shall adjourn or postpone the SPAC Shareholders' Meeting (1) to the extent necessary to ensure that any supplement or amendment to the Proxy/Registration Statement that SPAC or the Company reasonably determines (following consultation with the Company, except with respect to any Company Acquisition Proposal) is necessary to comply with applicable Laws, is provided to the SPAC Shareholders in advance of a vote on the adoption of the Transaction Proposals, (2) if, as of the time that the SPAC Shareholders' Meeting is originally scheduled, there are insufficient SPAC Shares represented at such meeting (either in person or by proxy) to constitute a quorum necessary to conduct the business of the SPAC Shareholders' Meeting, (3) if, as of the time that the SPAC Shareholders' Meeting is originally scheduled, adjournment or postponement of the SPAC Shareholders' Meeting is necessary to enable SPAC to solicit additional proxies required to obtain SPAC Shareholders' Approval, (4) in order to seek withdrawals from SPAC Shareholders who have exercised their SPAC Shareholder Redemption Right if a number of SPAC Shares have been elected to be redeemed such that SPAC reasonably expects that the condition set forth in Section 9.3(c) will not be satisfied at the Closing; or (5) to comply with applicable Law; **provided, further, however**, that without the prior written consent of the Company (such consent not to be unreasonably withheld, delayed or conditioned), SPAC shall not adjourn or postpone on more than two (2) occasions and so long as the date of the SPAC Shareholders' Meeting is not adjourned or postponed more than an aggregate of thirty (30) consecutive days.

(ii) The Proxy/Registration Statement shall include a statement to the effect that SPAC Board has unanimously recommended that the SPAC Shareholders vote in favor of the Transaction Proposals at the SPAC Shareholders' Meeting (such statement, the "**SPAC Board Recommendation**") and neither the SPAC Board nor any committee thereof shall withhold, withdraw, qualify, amend or modify, or publicly propose or resolve to withhold, withdraw, qualify, amend or modify, the SPAC Board Recommendation.

**Section 8.3 Support of Transaction.** Without limiting any covenant contained in Article VI, or Article VII (a) the Company shall, and shall cause its Subsidiaries (including the Merger Subs) to, and (b) SPAC shall, (i) use commercially reasonable efforts to obtain all material consents and approvals of third parties that the Company and any of its Subsidiaries or SPAC, as applicable, are required to obtain in order to consummate the Transactions (including the consents and approvals set forth in Section 8.3 of the Company Disclosure Letter), and (ii) use commercially reasonable efforts to take such other action as may be reasonably necessary or as another party hereto may reasonably request to satisfy the conditions of Article IX (including, in the case of SPAC, the use of commercially reasonable efforts to enforce its rights under the Forward Purchase Agreements) or otherwise to comply with this Agreement and to consummate the Transactions as soon as practicable; **provided, however,** that, notwithstanding anything contained in this Agreement to the contrary, nothing in this Agreement, including this Article VIII, shall require the Company, any of its Subsidiaries or SPAC or any of their respective Affiliates to (A) commence or threaten to commence, pursue or defend against any Action, whether judicial or administrative, (B) seek to have any stay or Governmental Order vacated or reversed, (C) propose, negotiate, commit to or effect by consent decree, hold separate order or otherwise, the sale, divestiture, licensing or disposition of any assets or businesses of the Company or any of its Subsidiaries or SPAC, (D) take or commit to take actions that limit the freedom of action of any of the Company, any of its Subsidiaries or SPAC with respect to, or the ability to retain, control or operate, or to exert full rights of ownership in respect of, any of the businesses, product lines or assets of the Company, any of its Subsidiaries or SPAC or (E) grant any financial, legal or other accommodation to any other Person, including agreeing to change any of the terms of the Transactions.

**Section 8.4 Tax Matters.**

(a) Each of SPAC, Merger Sub I, Merger Sub II, and the Group Companies shall (and shall cause their respective Affiliates to) cooperate fully, as and to the extent reasonably requested by each other, in connection with the filing of relevant Tax Returns and the defense of relevant Tax audits or other similar proceedings. Such cooperation shall include retaining and (upon reasonable request) providing (with the right to make copies) records and information reasonably relevant to any such Tax Returns or Tax audits or other similar proceedings, making employees available on a mutually convenient basis to provide additional information and explanation of any material provided hereunder, and, to the extent applicable, (i) making available to holders of SPAC Securities factual information reasonably necessary and in such person's possession or reasonably available to it to determine whether the Mergers may qualify for nonrecognition treatment, in whole or in part, under any provision of the Code (it being understood that (A) such holders shall rely on their own Tax advisors, and shall not rely on SPAC, the Merger Subs, the Group Companies, or any of their respective Affiliates or advisors, to make such determination and (B) no information so made available shall be construed as any representation by SPAC, the Merger Subs, the Group Companies, or any of their respective Affiliates or advisors with respect to the Tax treatment of the Transactions) and (ii) making available to SPAC Shareholders information reasonably necessary to compute the taxable income of SPAC Shareholders (or their direct or indirect owners) arising as a result of SPAC's status as a PFIC or a "controlled foreign corporation" within the meaning of Section 957(a) of the Code for any taxable period (or portion thereof) beginning on or before the Closing Date, including timely providing a PFIC Annual Information Statement (as described in Treasury Regulations Section 1.1295-1(g)) to enable SPAC Shareholders to make and maintain a "Qualified Electing Fund" election under Section 1295 of the Code and the Treasury Regulations promulgated thereunder and information to enable SPAC Shareholders to report their allocable share of "subpart F" income under Section 951 of the Code and "global intangible low-taxed income" under Section 951A of the Code.

(b) The Company shall, following the close of the taxable year in which the Closing occurs and the following taxable year, determine whether it is a PFIC. If the Company determines after the Closing that it is a PFIC for the taxable year in which the Closing occurs and the following taxable year, the Company shall also determine if any of its Subsidiaries is a PFIC and the Company shall provide sufficient information to its stockholders to enable them to make and maintain a timely and valid "**Qualified Electing Fund**" election under Section 1295 of the Code and the Treasury Regulations promulgated thereunder for the Company and any Subsidiary of the Company that is a PFIC.

(c) Upon the written request of a Company Shareholder or a SPAC Shareholder (or any direct or indirect owner thereof) that is a U.S. person for U.S. federal income Tax purposes and owns five percent (5%)

or more of the Company immediately after the Closing (directly or constructively, as determined under applicable Treasury Regulations), the Company shall use reasonable best efforts to (i) furnish to such Person such information as such Person reasonably requests in connection with such Person's preparation of any "gain recognition agreement" in accordance with Treasury Regulations Section 1.367(a)-8 and (ii) provide such Person with the information reasonably requested by such Person for purposes of determining whether there has been any "triggering event" (or potential "triggering event") as defined in Treasury Regulations Section 1.367(a)-8(j) under the terms of such agreement and, as applicable, information reasonably requested by such Person in connection with such triggering event to make a substitute gain recognition agreement.

(d) If, due to a change in United States Tax Law following the date of this Agreement, Merger Sub II is not able to obtain the United States entity classification described in Section 5.11 (i.e., as a "disregarded entity"), the parties hereto shall use commercially reasonable efforts to consummate the acquisition of SPAC by the Company in a manner that is as equivalent as practicable, for United States Tax purposes, to the transactions described herein; **provided** that any action to be taken pursuant to this Section 8.4(d) shall not cause any material delay to, or result in any material adverse effect on, the Closing.

(e) All Transfer Taxes will be borne by the party responsible therefor under applicable Law.

**Section 8.5 Shareholder Litigation.** The Company shall promptly advise SPAC, and SPAC, shall promptly advise the Company, as the case may be, of any Action commenced (or to the Knowledge of the Company or the Knowledge of SPAC, as applicable, threatened) on or after the date of this Agreement against such party, any of its Subsidiaries or any of its directors or officers by any Company Shareholder or SPAC Shareholder relating to this Agreement, the Mergers or any of the other Transactions (any such Action, "**Shareholder Litigation**"), and such party shall keep the other party reasonably informed regarding any such Shareholder Litigation. Other than with respect to any Shareholder Litigation where the parties identified in this sentence are adverse to each other or in the context of any Shareholder Litigation related to or arising out of a Company Acquisition Proposal or a SPAC Acquisition Proposal, (a) the Company shall give SPAC a reasonable opportunity to participate in the defense or settlement of any such Shareholder Litigation (and consider in good faith the suggestions of SPAC in connection therewith) brought against the Company, any of their respective Subsidiaries or any of their respective directors or officers and no such settlement shall be agreed to without the SPAC's prior consent (which consent shall not be unreasonably withheld, conditioned or delayed) and (b) SPAC shall give the Company a reasonable opportunity to participate in the defense or settlement of any such Shareholder Litigation (and consider in good faith the suggestions of the Company in connection therewith) brought against SPAC, any of its Subsidiaries or any of its directors or officers, and no such settlement shall be agreed to without the Company's prior consent (which consent shall not be unreasonably withheld, conditioned or delayed).

**Section 8.6 Forward Purchase Subscriptions.** Unless otherwise consented in writing by each of the Company and SPAC (which consent shall not be unreasonably withheld, conditioned or delayed), SPAC shall not permit any amendment or modification to be made to, any waiver (in whole or in part) or provide consent to (including consent to termination), any provision or remedy under, or any replacements of, any of the Forward Purchase Agreements. The SPAC shall procure that the Forward Purchase Investors perform their respective obligations under their respective Forward Purchase Agreements and complete the consummation of their respective Forward Purchase Subscriptions in full immediately prior to the First Merger Effective Time. Each of the parties shall use its commercially reasonable efforts to take, or cause to be taken, all actions and do, or cause to be done, all things necessary, proper or advisable to consummate the transactions contemplated by the Forward Purchase Agreements on the terms and conditions described therein, including maintaining in effect the Forward Purchase Agreements and to: (a) satisfy on a timely basis all conditions and covenants applicable to it in the Forward Purchase Agreements and otherwise comply with its obligations thereunder, (b) without limiting the rights of any party to enforce certain of such Forward Purchase Agreements in the event that all conditions in the Forward Purchase Agreements (other than conditions that the Company, SPAC or any of its Affiliates control the satisfaction of and other than those conditions that by their nature are to be satisfied at the closings under the Forward Purchase Agreements) have been satisfied, consummate the transactions contemplated by the Forward Purchase Agreements at or prior to the Closing; (c) confer with each other regarding timing of the expected closings under the Forward Purchase Agreements; and (d) deliver notices to the applicable counterparties to the Forward Purchase Agreements sufficiently in

advance of the Closing to cause them to fund their obligations as far in advance of the Closing as permitted by the Forward Purchase Agreements. Without limiting the generality of the foregoing, SPAC shall give the Company prompt written notice: (A) of any breach or default (or any event or circumstance that, with or without notice, lapse of time or both, could give rise to any breach or default) by any party to any Forward Purchase Agreement known to; (B) of the receipt of any notice or other communication from any party to any Forward Purchase Agreement by SPAC with respect to any actual, potential, threatened or claimed expiration, lapse, withdrawal, material breach, material default, termination or repudiation by any party to any Forward Purchase Agreement or any provisions of any Forward Purchase Agreement; and (C) if SPAC does not expect to receive, all or any portion of the Forward Purchase Investment Amount on the terms, in the manner or from the Forward Purchase Investors as contemplated by the Forward Purchase Agreements. SPAC shall take all actions required under the Forward Purchase Agreements with respect to the timely book-entry or issuance and delivery of any physical certificates evidencing the SPAC Ordinary Shares and the SPAC Warrants as and when required under any such Forward Purchase Agreements.

**Section 8.7 Use of Remaining Trust Fund Proceeds.** Subject to the satisfaction or waiver of the conditions set forth in Article IX (other than those conditions that by their nature are to be satisfied at the Closing, but subject to the satisfaction or waiver of such conditions), of the Remaining Trust Fund Proceeds, an amount equal to the lesser of (a) 50% of all amounts in the Trust Account immediately prior to the Closing, without taking into account of the SPAC Shareholder Redemption Amount, and (b) all amounts in the Trust Account immediately prior to the Closing, taking into account the SPAC Shareholder Redemption Amount, shall remain with the Company and be (i) used in the operations of the Company or the members of the Company's "qualified group" within the meaning of Treasury Regulations Section 1.368-1(d)(4)(ii) and/or (ii) loaned to the Group Companies to be used in the business operations of the Group Companies, in each case, such amounts to be used in a manner that would not impair the ability of the Mergers, taken together, to qualify as a "reorganization" within the meaning of Section 368 of the Code. Notwithstanding the foregoing, none of SPAC or the Group Companies make any representation regarding whether the Mergers, taken together, will qualify as a "reorganization" within the meaning of Section 368 of the Code.

## ARTICLE IX

### CONDITIONS TO OBLIGATIONS

**Section 9.1 Conditions to Obligations of SPAC, the Merger Subs and the Company.** The obligations of SPAC, the Merger Subs and the Company to consummate, or cause to be consummated, the Transactions to occur at the Closing are each subject to the satisfaction of the following conditions, any one or more of which may be waived (if legally permitted) in writing by the party or parties whose obligations are conditioned thereupon:

- (a) The SPAC Shareholders' Approval shall have been obtained, and shall have not been withdrawn, revoked or varied or become invalid;
- (b) The Company Shareholders' Approval shall have been obtained, and shall have not been withdrawn or become invalid;
- (c) The Company Lender's Approval shall have been obtained, and shall have not been withdrawn or become invalid;
- (d) Each of the Transaction Documents, as amended, and the BofA Waiver Letter shall remain enforceable in accordance with its terms and shall have not been withdrawn or become invalid;
- (e) The Proxy/Registration Statement shall have become effective under the Securities Act and no stop order suspending the effectiveness of the Proxy/Registration Statement shall have been issued and no proceedings for that purpose shall have been initiated or threatened by the SEC and not withdrawn;
- (f) (i) The Company's initial listing application with Nasdaq in connection with the Transactions shall have been conditionally approved and, immediately following the Closing, the Company shall satisfy any applicable initial and continuing listing requirements of Nasdaq, including the applicable public float requirements under Nasdaq listing rules and the Company shall not have received any notice of

non-compliance therewith, and (ii) the Company Ordinary Shares and Company Warrants to be issued in connection with the Transactions shall have been approved for listing on Nasdaq, subject to official notice of issuance;

(g) After deducting the SPAC Shareholder Redemption Amount, SPAC shall have at least \$5,000,001 of net tangible assets (as determined in accordance with Rule 3a51-1(g)(1) of the Exchange Act); and

(h) No Governmental Authority shall have enacted, issued, promulgated, enforced or entered any Law (whether temporary, preliminary or permanent) or Governmental Order that is then in effect and which has the effect of making the Closing illegal or which otherwise prevents or prohibits consummation of the Closing (any of the foregoing, a “restraint”), other than any such restraint that is immaterial.

**Section 9.2 Conditions to Obligations of SPAC at Closing.** The obligations of SPAC to consummate, or cause to be consummated, the Transactions to occur at the Closing are subject to the satisfaction of the following additional conditions as of the Closing Date, any one or more of which may be waived in writing by SPAC:

(a) The representations and warranties contained in Section 3.3 (Capitalization of the Company), Section 3.4 (Capitalization of Subsidiaries), Section 3.5 (Authorization), Section 3.10(b) (Absence of Changes), Section 5.2 (Capitalization and Voting Rights) and Section 5.4 (Authorization) shall be true and correct in all respects as of the Closing Date as if made at the Closing Date. Each of the other representations and warranties of the Company and the Merger Subs contained in this Agreement shall be true and correct in all material respects as of the Closing Date as if made at the Closing Date (except with respect to such representations and warranties which speak as to an earlier date, which representations and warranties shall be true and correct in all material respects at and as of such date), except where the failure of such representations and warranties to be so true and correct, individually or in the aggregate, has not had, and would not reasonably be expected to have, a Company Material Adverse Effect;

(b) Each of the obligations and covenants of the Company and the Merger Subs as set forth in this Agreement and to be performed as of or prior to the Closing Date shall have been performed in all material respects, unless the applicable obligation has a materiality qualifier or similar qualification or exception in which case it shall have been duly performed in all respects;

(c) The Company Capital Restructuring shall have been completed; and

(d) There shall have not been a Company Material Adverse Effect following the date of this Agreement that is continuing and uncured.

**Section 9.3 Conditions to Obligations of the Company and the Merger Subs at Closing.** The obligations of the Company and the Merger Subs to consummate, or cause to be consummated, the Transactions to occur at the Closing are subject to the satisfaction of the following additional conditions as of the Closing Date, any one or more of which may be waived in writing by the Company:

(a) The representations and warranties contained in Section 4.3 (Corporate Structure; Subsidiaries), Section 4.4 (Authorization) and Section 4.8(ii) (Absence of Changes) shall be true and correct in all respects as of the Closing Date as if made at the Closing Date. Each of the other representations and warranties of SPAC contained in this Agreement shall be true and correct in all material respects as of the Closing Date (except with respect to such representations and warranties which speak as to an earlier date, which representations and warranties shall be true and correct in all material respects at and as of such date), except where the failure of such representations and warranties to be so true and correct, individually or in the aggregate, has not had, and would not reasonably be expected to have, a SPAC Material Adverse Effect;

(b) Each of the obligations and covenants of SPAC as set forth in this Agreement and to be performed as of or prior to the Closing Date shall have been performed in all material respects, unless the applicable obligation has a materiality qualifier or similar qualification or exception in which case it shall have been duly performed in all respects;

(c) The Available Closing Cash Amount is not less than \$30,000,000; and

(d) There shall have not been a SPAC Material Adverse Effect following the date of this Agreement that is continuing and uncured.

**Section 9.4 Frustration of Conditions.** None of SPAC, the Merger Subs or the Company may rely on the failure of any condition set forth in this Article IX to be satisfied if such failure was caused by such party's failure to comply in all material respects with its obligations under Section 8.3.

## ARTICLE X

### TERMINATION/EFFECTIVENESS

**Section 10.1 Termination.** This Agreement may be terminated and the Transactions abandoned at any time prior to the First Merger Effective Time:

(a) by mutual written consent of the Company and SPAC;

(b) by written notice from the Company or SPAC to the other if any Governmental Authority shall have enacted, issued, promulgated, enforced or entered any Governmental Order which has become final and non-appealable and has the effect of permanently making consummation of the Transactions illegal or otherwise preventing or prohibiting consummation of the Transactions;

(c) by written notice from the Company to SPAC if the SPAC Board or any committee thereof has withheld, withdrawn, qualified, amended or modified, or publicly proposed or resolved to withhold, withdraw, qualify, amend or modify, the SPAC Board Recommendation;

(d) by written notice from the Company to SPAC if the SPAC Shareholders' Approval shall not have been obtained by reason of the failure to obtain the required vote at the SPAC Shareholders' Meeting duly convened therefor or at any adjournment or postponement thereof taken in accordance with this Agreement;

(e) by written notice from SPAC to the Company if the SPAC Shareholders' Approval shall not have been obtained by reason of the failure to obtain the required vote at the SPAC Shareholders' Meeting duly convened therefor or at any adjournment or postponement thereof taken in accordance with this Agreement, which termination right shall not be exercisable by SPAC if SPAC has materially breached any of its obligations under Article VIII;

(f) by written notice from SPAC to the Company if there is any breach of any representation, warranty, covenant or agreement on the part of the Company or a Merger Sub set forth in this Agreement, such that the conditions specified in Section 9.2 would not be satisfied at the relevant Closing Date (a "**Terminating Company Breach**"), except that, if such Terminating Company Breach is curable by the Company or such Merger Sub then, for a period of up to 30 days after receipt by the Company of written notice from SPAC of such breach, such termination shall not be effective, and such termination shall become effective only if the Terminating Company Breach is not cured within such 30-day period, **provided** that SPAC shall not have the right to terminate this Agreement pursuant to this Section 10.1(f) if it is then in material breach of any of its representations, warranties, covenants or agreements set forth in this Agreement;

(g) by written notice from the Company to SPAC if there is any breach of any representation, warranty, covenant or agreement on the part of SPAC set forth in this Agreement, such that the conditions specified in Section 9.3 would not be satisfied at the relevant Closing Date (a "**Terminating SPAC Breach**"), except that if any such Terminating SPAC Breach is curable by SPAC then, for a period of up to 30 days after receipt by SPAC of written notice from the Company of such breach, such termination shall not be effective, and such termination shall become effective only if the Terminating SPAC Breach is not cured within such 30-day period, **provided** that Company shall not have the right to terminate this Agreement pursuant to this Section 10.1(g) if it is then in material breach of any of its representations, warranties, covenants or agreements set forth in this Agreement;

(h) by written notice from SPAC to the Company if any Company Shareholder rescinds, revokes, withholds, withdraws, qualifies, amends or modifies the Company Shareholders' Approval, **provided** that SPAC shall not have the right to terminate this Agreement pursuant to this Section 10.1(h) if such rescission,



revocation, withholding, withdrawal, qualification, amendment or modification of the Company Shareholders' Approval results from a material amendment to the Transaction Documents;

(i) by written notice from SPAC to the Company if any director or shareholder of Merger Sub I or Merger Sub II rescinds, revokes, withholds, withdraws, qualifies, amends or modifies the Merger Sub I Written Resolutions or Merger Sub II Written Resolutions, as applicable, prior to the First Merger Effective Time or the Second Merger Effective Time, as applicable;

(j) by written notice from SPAC or the Company to the other, if the transactions contemplated by this Agreement shall not have been consummated on or prior to the 270<sup>th</sup> day after the date hereof (and if such 270<sup>th</sup> day shall not be a Business Day, then the next following Business Day); **provided** that the right to terminate this Agreement pursuant to this Section 10.1(j) will not be available to any party whose breach of any provision of this Agreement primarily caused or resulted in the failure of the transactions to be consummated by such time; or

(k) by written notice from the Company to SPAC if the condition set forth in Section 9.3(c) becomes incapable of being satisfied at the Closing without any amendments, modifications or supplements to, or waivers under, this Agreement.

**Section 10.2 Effect of Termination.** In the event of the termination of this Agreement pursuant to Section 10.1, this Agreement shall forthwith become void and have no effect, without any liability on the part of any party hereto or its respective Affiliates, officers, directors or shareholders, other than liability of the Company, SPAC or the Merger Subs, as the case may be, for actual fraud or for any willful and material breach of this Agreement occurring prior to such termination, except that the provisions of this Section 10.2, the last sentence of Section 8.2(a)(i), Article XI and the NDA shall survive any termination of this Agreement. In the event that the First Merger does not occur on the same day as the Company Capital Restructuring or a later date as otherwise agreed in writing by the Majority Preferred Holders (as defined in the Company Charter), the Company shall, as soon as practicable and in no event later than 10:00 a.m. on the immediately following Business Day or a later date as otherwise agreed in writing by the Majority Preferred Holders (as defined in the Company Charter), take all such actions as are necessary, proper, required or advisable under the Company Charter and applicable Laws to reverse and unwind the Company Capital Restructuring as if it had never occurred.

## ARTICLE XI

### MISCELLANEOUS

**Section 11.1 Trust Account Waiver.** Notwithstanding anything to the contrary set forth in this Agreement, each of the Company and the Merger Subs acknowledges that it has read the publicly filed final prospectus of SPAC, filed with the SEC on June 10, 2021 (File No. 333-255722), including the Trust Agreement, and understands that SPAC has established the trust account described therein (the "**Trust Account**") for the benefit of SPAC's public shareholders and that disbursements from the Trust Account are available only in the limited circumstances set forth therein. Each of the Company and the Merger Subs further acknowledges and agrees that SPAC's sole assets consist of the cash proceeds of SPAC's initial public offering (the "**IPO**") and private placements of its securities occurring simultaneously with the IPO, and that substantially all of these proceeds have been deposited in the Trust Account for the benefit of its public shareholders. Accordingly, the Company (on behalf of itself and its Affiliates) and the Merger Subs hereby waive any past, present or future claim of any kind arising out of this Agreement against, and any right to access, the Trust Account, any trustee of the Trust Account or SPAC, to collect from the Trust Account any monies that may be owed to them by SPAC or any of its Affiliates for any reason whatsoever, and will not seek recourse against the Trust Account at any time for any reason whatsoever, including for any knowing and intentional breach by any of the parties to this Agreement of any of its representations or warranties as set forth in this Agreement, or such party's material breach of any of its covenants or other agreements set forth in this Agreement, which material breach constitutes, or is a consequence of, a purposeful act or failure to act by such party with the knowledge that the taking of such act or failure to take such act would cause a material breach of this Agreement. This Section 11.1 shall survive the termination of this Agreement for any reason.

**Section 11.2 Waiver.** Any party to this Agreement may, at any time prior to the Closing, by action taken by its board of directors or officers or Persons thereunto duly authorized, (a) extend the time for the performance of the obligations or acts of the other parties hereto, (b) waive any inaccuracies in the representations and warranties (of another party hereto) that are contained in this Agreement or (c) waive compliance by the other parties hereto with any of the agreements or conditions contained in this Agreement, but such extension or waiver shall be valid only if set forth in an instrument in writing signed by the party granting such extension or waiver.

**Section 11.3 Notices.** All general notices, demands or other communications required or permitted to be given or made hereunder shall be in writing and delivered personally or sent by courier or sent by registered post or sent by electronic mail to the intended recipient thereof at its address or at its email address set out below (or to such other address or email address as a party may from time to time notify the other parties). Any such notice, demand or communication shall be deemed to have been duly served (a) if given personally or sent by courier, upon delivery during normal business hours at the location of delivery or, if later, then on the next Business Day after the day of delivery; (b) if sent by electronic mail during normal business hours at the location of delivery, immediately, or, if later, then on the next Business Day after the day of delivery; (c) the third Business Day following the day sent by reputable international overnight courier (with written confirmation of receipt), and (d) if sent by registered post, five days after posting. The initial addresses and email addresses of the parties for the purpose of this Agreement are:

(a) If to SPAC, to:

Summit Healthcare Acquisition Corp.  
Unit 1101, 11th Floor  
1 Lyndhurst Tower  
1 Lyndhurst Terrace, Central

Hong Kong  
Attention: Bo Tan, Chief Executive Officer, Ken Poon, President  
Email: [\*\*\*], [\*\*\*]

with a copy (which shall not constitute notice) to:

Cooley LLP  
c/o 35th Floor, Two Exchange Square  
8 Connaught Place, Central  
Hong Kong  
Attention: Will Cai, Yiming Liu  
E-mail: wcai@cooley.com, yimingliu@cooley.com

(b) If to the Company or any Merger Sub, to:

YishengBio Co., Ltd.  
Address: Building No.2, 38 Yongda Road, Daxing Biomedical Industry Park,  
Daxing District, Beijing, PRC  
Attention: David Hui Shao  
E-mail: [\*\*\*]

with a copy (which shall not constitute notice) to:

Wilson Sonsini Goodrich & Rosati  
Unit 2901, 29F, Tower C, Beijing Yintai Centre, No. 2 Jianguomenwai Avenue,  
Chaoyang District, Beijing, PRC  
Email: projecthudson@wsgr.com; douyang@wsgr.com  
Attention: Project Hudson team; Dan Ouyang

**Section 11.4 Assignment.** No party hereto shall assign this Agreement or any part hereof without the prior written consent of the other parties hereto and any such transfer without prior written consent shall be void. Subject to the foregoing, this Agreement shall be binding upon and inure to the benefit of the parties hereto and their respective permitted successors and assigns.

**Section 11.5 Rights of Third Parties.** Nothing expressed or implied in this Agreement is intended or shall be construed to (a) confer upon or give any Person (including any equityholder, any current or former director, manager, officer, employee or independent contractor of the Company or any of its Subsidiaries, or any participant in any Benefit Plan or other employee benefit plan, agreement or other arrangement (or any dependent or beneficiary thereof)), other than the parties hereto, any right or remedies under or by reason of this Agreement, (b) establish, amend or modify any employee benefit plan, program, policy, agreement or arrangement or (c) limit the right of SPAC, the Company, the Merger Subs or their respective Affiliates to amend, terminate or otherwise modify any Benefit Plan or other employee benefit plan, policy, agreement or other arrangement following the Closing; **provided, however,** that (i) the D&O Indemnified Parties (and their successors, heirs and representatives) are intended third-party beneficiaries of, and may enforce, Section 6.4, (ii) the Non-Recourse Parties (and their respective successors, heirs and representatives), are intended third-party beneficiaries of, and may enforce, Section 11.17, and (iii) the SPAC Director is an intended third party beneficiary of, and may enforce after the Closing, the rights of SPAC under this Section 11.5(c)(iii) and all other rights expressly described in this Agreement as being rights of SPAC.

**Section 11.6 Expenses.** Except as set forth in Section 8.2(a)(i), each party hereto shall be responsible for and pay its own expenses incurred in connection with this Agreement and the Transactions, including all fees of its legal counsel, financial advisers and accountants; **provided, however,** that (i) if the Closing shall not occur, the Company shall be responsible for paying the Company Transaction Expenses, and SPAC shall be responsible for paying the SPAC Transaction Expenses, and (ii) if the Closing shall occur, the Company shall pay or cause to be paid (A) Transfer Taxes and (B) in accordance with Section 2.3(b)(vii), the SPAC Transaction Expenses and the Company Transaction Expenses. Notwithstanding the foregoing or anything to the contrary in this Agreement or any other Transaction Document, the Company shall not be responsible for paying any amount of SPAC Transaction Expenses and SPAC's operating expenses that exceeds the amounts as agreed between the Company and SPAC on the date hereof, and Sponsor shall be responsible for paying the expenses in excess of such mutually agreed amounts.

**Section 11.7 Governing Law.** This Agreement, and any claim or cause of action hereunder based upon, arising out of or related to this Agreement (whether based on law, in equity, in contract, in tort or any other theory) or the negotiation, execution, performance or enforcement of this Agreement, shall be governed by and construed in accordance with the laws of the State of New York, without giving effect to the principles of conflicts of laws that would otherwise require the application of the law of any other state (**provided** that the fiduciary duties of the Company Board and the SPAC Board, the Mergers and any exercise of appraisal and dissenters' rights under the laws of the Cayman Islands with respect to the Mergers, shall in each case be governed by the laws of the Cayman Islands).

**Section 11.8 Consent to Jurisdiction; Waiver of Trial by Jury.** THE PARTIES HERETO IRREVOCABLY SUBMIT TO THE EXCLUSIVE JURISDICTION OF (I) THE FEDERAL COURTS OF THE UNITED STATES OF AMERICA LOCATED IN THE CITY AND COUNTY OF NEW YORK, BOROUGH OF MANHATTAN OR (II) THE COURTS OF THE STATE OF NEW YORK LOCATED IN THE CITY AND COUNTY OF NEW YORK, BOROUGH OF MANHATTAN SOLELY IN RESPECT OF THE INTERPRETATION AND ENFORCEMENT OF THE PROVISIONS OF THIS AGREEMENT AND THE TRANSACTIONS CONTEMPLATED HEREBY, AND HEREBY WAIVE, AND AGREE NOT TO ASSERT, AS A DEFENSE IN ANY ACTION, SUIT OR PROCEEDING FOR INTERPRETATION OR ENFORCEMENT HEREOF, THAT SUCH ACTION, SUIT OR PROCEEDING MAY NOT BE BROUGHT OR IS NOT MAINTAINABLE IN SAID COURTS OR THAT VENUE THEREOF MAY NOT BE CONVENIENT OR APPROPRIATE OR THAT THIS AGREEMENT MAY NOT BE ENFORCED IN OR BY SUCH COURTS, AND THE PARTIES HERETO IRREVOCABLY AGREE THAT ALL CLAIMS WITH RESPECT TO SUCH ACTION, SUIT OR PROCEEDING SHALL BE HEARD AND DETERMINED BY SUCH A NEW YORK STATE OR FEDERAL COURT. THE PARTIES HEREBY CONSENT TO AND GRANT ANY SUCH COURT JURISDICTION OVER THE PERSON OF SUCH PARTIES AND OVER THE SUBJECT MATTER OF SUCH DISPUTE AND AGREE THAT MAILING OF PROCESS OR OTHER PAPERS IN CONNECTION WITH SUCH ACTION, SUIT OR PROCEEDING IN THE MANNER PROVIDED IN SECTION 11.3 OR IN SUCH OTHER MANNER AS MAY BE PERMITTED BY LAW SHALL BE VALID AND SUFFICIENT SERVICE THEREOF. EACH PARTY ACKNOWLEDGES AND AGREES THAT ANY CONTROVERSY WHICH MAY ARISE UNDER THIS AGREEMENT OR THE

TRANSACTIONS CONTEMPLATED HEREBY IS LIKELY TO INVOLVE COMPLICATED AND DIFFICULT ISSUES, AND THEREFORE EACH SUCH PARTY HEREBY IRREVOCABLY AND UNCONDITIONALLY WAIVES ANY RIGHT SUCH PARTY MAY HAVE TO A TRIAL BY JURY IN RESPECT OF ANY LITIGATION DIRECTLY OR INDIRECTLY ARISING OUT OF OR RELATING TO THIS AGREEMENT OR THE TRANSACTIONS CONTEMPLATED BY THIS AGREEMENT. EACH PARTY CERTIFIES AND ACKNOWLEDGES THAT (I) NO REPRESENTATIVE, AGENT OR ATTORNEY OF ANY OTHER PARTY HAS REPRESENTED, EXPRESSLY OR OTHERWISE, THAT SUCH OTHER PARTY WOULD NOT, IN THE EVENT OF LITIGATION, SEEK TO ENFORCE THE FOREGOING WAIVER; (II) SUCH PARTY UNDERSTANDS AND HAS CONSIDERED THE IMPLICATIONS OF THE FOREGOING WAIVER; (III) SUCH PARTY MAKES THE FOREGOING WAIVER VOLUNTARILY AND (IV) SUCH PARTY HAS BEEN INDUCED TO ENTER INTO THIS AGREEMENT BY, AMONG OTHER THINGS, THE MUTUAL WAIVER AND CERTIFICATIONS IN THIS SECTION 11.8.

**Section 11.9 Headings; Counterparts.** The headings in this Agreement are for convenience only and shall not be considered a part of or affect the construction or interpretation of any provision of this Agreement. This Agreement may be executed in two or more counterparts, and by different parties in separate counterparts, with the same effect as if all parties hereto had signed the same document, but all of which together shall constitute one and the same instrument. Copies of executed counterparts of this Agreement transmitted by electronic transmission (including by email or in .pdf format) or facsimile as well as electronically or digitally executed counterparts (such as DocuSign) shall have the same legal effect as original signatures and shall be considered original executed counterparts of this Agreement.

**Section 11.10 Disclosure Letters.** The Disclosure Letters (including, in each case, any section thereof) referenced in this Agreement are a part of this Agreement as if fully set forth herein. All references in this Agreement to the Disclosure Letters (including, in each case, any section thereof) shall be deemed references to such parts of this Agreement, unless the context shall otherwise require. Any disclosure made by a party in the applicable Disclosure Letter, or any section thereof, with reference to any section of this Agreement or section of the applicable Disclosure Letter shall be deemed to be a disclosure with respect to such other applicable sections of this Agreement or sections of the applicable Disclosure Letter to which it is reasonably apparent on the face of such disclosure that such disclosure is responsive to such other section of this Agreement or section of the applicable Disclosure Letter. Certain information set forth in the Disclosure Letters is included solely for informational purposes and may not be required to be disclosed pursuant to this Agreement. The disclosure of any information shall not be deemed to constitute an acknowledgment that such information is required to be disclosed in connection with the representations and warranties made in this Agreement, nor shall such information be deemed to establish a standard of materiality or that the facts underlying such information constitute a Company Material Adverse Effect or a SPAC Material Adverse Effect, as applicable.

**Section 11.11 Entire Agreement.** This Agreement (together with the Disclosure Letters), the NDA and the other Transaction Documents constitute the entire agreement among the parties to this Agreement relating to the Transactions and supersede any other agreements, whether written or oral, that may have been made or entered into by or among any of the parties hereto or any of their respective Subsidiaries relating to the Transactions (including the Letter of Intent between SPAC and the Company, dated as of July 1, 2022). No representations, warranties, covenants, understandings, agreements, oral or otherwise, relating to the Transactions exist between such parties except as expressly set forth in the Transaction Documents.

**Section 11.12 Amendments.** This Agreement may be amended or modified in whole or in part prior to the First Merger Effective Time, only by a duly authorized agreement in writing in the same manner as this Agreement, which makes reference to this Agreement and which shall be executed by the Company, SPAC and the Merger Subs; **provided, however**, that after the Company Shareholder Approval or the SPAC Shareholders' Approval has been obtained, there shall be no amendment that by applicable Law, the Company Charter or the SPAC Charter or their respective currently effective shareholders agreements requires further approval by the shareholders of the Company or the shareholders of SPAC, respectively, without such approval having been obtained.

**Section 11.13 Publicity.**

(a) All press releases or other public communications relating to the Transactions, and the method of the release for publication thereof, shall, prior to the Closing, be subject to the prior mutual approval of SPAC and the Company; **provided**, that no such party shall be required to obtain consent pursuant to this Section 11.13(a) to the extent any proposed release or statement is substantially equivalent to the information that has previously been made public without breach of the obligation under this Section 11.13(a).

(b) The restriction in Section 11.13(a) shall not apply to the extent the public announcement is required by applicable securities Law, any Governmental Authority or stock exchange rule; **provided, however**, that in such an event, the party making the announcement shall, to the extent practicable, use its commercially reasonable efforts to consult with the other party in advance as to its form, content and timing.

**Section 11.14 Confidentiality.** The existence and terms of this Agreement are confidential and may not be disclosed by either party hereto, their respective Affiliates or any Representatives of any of the foregoing, and shall at all times be considered and treated as “**Confidential Information**” as such term is defined in the NDA. Notwithstanding anything to the contrary contained in the preceding sentence or in the NDA, each party shall be permitted to disclose Confidential Information, including the Transaction Documents, the fact that the Transaction Documents have been signed and the status and terms of the Transactions to its existing or potential Affiliates, joint ventures, joint venture partners, shareholders, lenders, underwriters, financing sources and any Governmental Authority (including Nasdaq), and to the extent required, in regulatory filings, and their respective Representatives; **provided** that such parties entered into customary confidentiality agreements or are otherwise bound by fiduciary or other duties to keep such information confidential.

**Section 11.15 Severability.** If any provision of this Agreement is held invalid or unenforceable by any court of competent jurisdiction, the other provisions of this Agreement shall remain in full force and effect. The parties hereto further agree that if any provision contained in this Agreement is, to any extent, held invalid or unenforceable in any respect under the Laws governing this Agreement, they shall take any actions necessary to render the remaining provisions of this Agreement valid and enforceable to the fullest extent permitted by Law and, to the extent necessary, shall amend or otherwise modify this Agreement to replace any provision contained in this Agreement that is held invalid or unenforceable with a valid and enforceable provision giving effect to the intent of the parties hereto.

**Section 11.16 Enforcement.** The parties hereto agree that irreparable damage would occur in the event that any of the provisions of this Agreement were not performed in accordance with their specific terms or were otherwise breached. It is accordingly agreed that the parties hereto shall be entitled to an injunction or injunctions to prevent breaches of this Agreement and to specific enforcement of the terms and provisions of this Agreement, in addition to any other remedy to which any party is entitled at law or in equity. In the event that any Action shall be brought in equity to enforce the provisions of this Agreement, no party shall allege, and each party hereby waives the defense, that there is an adequate remedy at law, and each party agrees to waiver any requirement for the securing or posting of any bond in connection therewith.

**Section 11.17 Non-Recourse.** This Agreement may only be enforced against, and any claim or cause of action based upon, arising out of, or related to this Agreement or the Transactions may only be brought against, the Persons that are expressly named as parties hereto and then only with respect to the specific obligations set forth herein with respect to such party. Except to the extent a party hereto (and then only to the extent of the specific obligations undertaken by such party to this Agreement or any other Transaction Document), (i) no past, present or future director, officer, employee, incorporator, member, partner, shareholder, stockholder, Affiliate, agent, attorney, advisor or other Representative of any party hereto and (ii) no past, present or future director, officer, employee, incorporator, member, partner, shareholder, stockholder, Affiliate, agent, attorney, advisor or other Representative of any of the foregoing shall have any liability (whether in contract, tort, equity or otherwise) for any one or more of the representations, warranties, covenants, agreements or other obligations or liabilities of any one or more of the Company, the Merger Subs or SPAC under this Agreement of or for any claim based on, arising out of, or related to this Agreement or the Transactions (each of the Persons identified in the foregoing sub-clauses (a) or (b), a “**Non-Recourse Party**”, and collectively, the “**Non-Recourse Parties**”).

**Section 11.18 Non-Survival of Representations, Warranties and Covenants.** Except as otherwise contemplated by Section 10.2, the representations, warranties, covenants, obligations or other agreements in

this Agreement or in any certificate (including confirmations therein), statement or instrument delivered pursuant to this Agreement, including any rights arising out of any breach of such representations, warranties, covenants, obligations, agreements and other provisions, shall not survive the Closing and shall terminate and expire upon the occurrence of the Closing (and there shall be no liability after the Closing in respect thereof), except for (a) those covenants and agreements contained in this Agreement that by their terms expressly apply in whole or in part after the Closing, and then only with respect to any breaches occurring after the Closing and (b) this Article XI.

#### **Section 11.19 Conflicts and Privilege.**

(a) The Company, SPAC and the Merger Subs, on behalf of their respective successors and assigns, hereby agree that, in the event a dispute with respect to this Agreement or the transactions contemplated hereby arises after the Closing between or among (x) the Sponsor, the shareholders or holders of other equity interests of SPAC or the Sponsor or any of their respective directors, members, partners, officers, employees or Affiliates (other than the Company or the Surviving Company) (collectively, the “**SMH Group**”), on the one hand, and (y) the Company, the Surviving Company or any member of the YSB Group, on the other hand, any legal counsel, including Cooley LLP (“**Cooley**”) and Ogier, that represented SPAC or the Sponsor prior to the Closing may represent the Sponsor or any other member of the SMH Group, in such dispute even though the interests of such Persons may be directly adverse to the Company, the Surviving Company or the Surviving Company, and even though such counsel may have represented SPAC in a matter substantially related to such dispute, or may be handling ongoing matters for the Company, the Surviving Company, the Surviving Company or the Sponsor. The Company, SPAC and the Merger Subs, on behalf of their respective successors and assigns (including, after the Closing, the Surviving Company), further agree that, as to all legally privileged communications prior to the Closing (made in connection with the negotiation, preparation, execution, delivery and performance under, or any dispute or Action arising out of or relating to, this Agreement, any Transaction Documents or the transactions contemplated hereby or thereby) between or among SPAC, the Sponsor or any other member of the SMH Group, on the one hand, and Cooley or Ogier, on the other hand, the attorney/client privilege and the expectation of client confidence shall survive the Closing and belong to the SMH Group after the Closing, and shall not pass to or be claimed or controlled by the Company or the Surviving Company. Notwithstanding the foregoing, any privileged communications or information shared by the Company prior to the Closing with SPAC or the Sponsor under a common interest agreement shall remain the privileged communications or information of the Company and the Surviving Company.

(b) The Company, SPAC and the Merger Subs, on behalf of their respective successors and assigns, hereby agree that, in the event a dispute with respect to this Agreement or the transactions contemplated hereby arises after the Closing between or among (x) the shareholders or holders of other equity interests of the Company or any of their respective directors, members, partners, officers, employees or Affiliates (other than the Company or the Surviving Company) (collectively, the “**YSB Group**”), on the one hand, and (y) the Surviving Company or any member of the SMH Group, on the other hand, any legal counsel, including Wilson Sonsini Goodrich & Rosati (“**WSGR**”) and Maples and Calder (Hong Kong) LLP (“**Maples**”) that represented the Company prior to the Closing may represent any member of the YSB Group in such dispute even though the interests of such Persons may be directly adverse to the Company and the Surviving Company, and even though such counsel may have represented the Company in a matter substantially related to such dispute, or may be handling ongoing matters for the Company and the Surviving Company. The Company, SPAC and the Merger Subs, on behalf of their respective successors and assigns (including, after the Closing, the Surviving Company), further agree that, as to all legally privileged communications prior to the Closing (made in connection with the negotiation, preparation, execution, delivery and performance under, or any dispute or Action arising out of or relating to, this Agreement, any Transaction Documents or the transactions contemplated hereby or thereby) between or among the Company or any member of the YSB Group, on the one hand, and WSGR or Maples, on the other hand, the attorney/client privilege and the expectation of client confidence shall survive the Closing and belong to the YSB Group after the Closing, and shall not pass to or be claimed or controlled by the Company or the Surviving Company. Notwithstanding the foregoing, any privileged communications or information shared by SPAC or Sponsor prior to the Closing with the Company under a common interest agreement shall remain the privileged communications or information of the Company or the Surviving Company.

*[Remainder of page intentionally left blank]*

IN WITNESS WHEREOF the parties have hereunto caused this Agreement to be duly executed as of the date first above written.

**SPAC:**

**Summit Healthcare Acquisition Corp.**

By: /s/ Ken Poon

\_\_\_\_\_  
Name: Ken Poon

Title: President

**MERGER SUB I:**

**Oceanview Bioscience Acquisition Co., Ltd.**

By: /s/ Zhang Yi

\_\_\_\_\_  
Name: Zhang Yi

Title: Director

**MERGER SUB II:**

**Hudson Biomedical Group Co., Ltd.**

By: /s/ Zhang Yi

\_\_\_\_\_  
Name: Zhang Yi

Title: Director

**COMPANY:**

**YishengBio Co., Ltd.**

By: /s/ Zhang Yi

\_\_\_\_\_  
Name: Zhang Yi

Title: Director

[Signature Page to Business Combination Agreement]

---

**EXHIBIT A**

**FORM OF SHAREHOLDER SUPPORT AGREEMENT**

---



**EXHIBIT B**

**FORM OF WARRANT ASSIGNMENT AGREEMENT**

---

**EXHIBIT C-1**

**FORM OF PLAN OF FIRST MERGER**

---

**EXHIBIT C-2**

**FORM OF PLAN OF SECOND MERGER**

---

**EXHIBIT D-1**

**FORM OF AMENDED ARTICLES OF THE SURVIVING ENTITY**



**EXHIBIT D-2**

**FORM OF AMENDED ARTICLES OF THE SURVIVING COMPANY**

---

**EXHIBIT E**

**FORM OF AMENDED COMPANY CHARTER**

---

**EXHIBIT F**

**FORM OF AMENDED COMPANY INCENTIVE PLAN**

---

**THE COMPANIES ACT (AS REVISED)  
OF THE CAYMAN ISLANDS  
COMPANY LIMITED BY SHARES**

**SECOND AMENDED AND RESTATED  
MEMORANDUM OF ASSOCIATION  
OF  
YS Biopharma Co., Ltd**

(Adopted by a Special Resolution passed on [•] 2022 and effective on [•] 2022)

1. The name of the Company is **YS Biopharma Co., Ltd**.
2. The Registered Office of the Company will be at the offices of Maples Corporate Services Limited, PO Box 309, Ugland House, Grand Cayman, KY1-1104, Grand Cayman KY1-1104, Cayman Islands, or at such other location within the Cayman Islands as the Directors may from time to time determine.
3. The objects for which the Company is established are unrestricted and the Company shall have full power and authority to carry out any object not prohibited by the Companies Act or any other law of the Cayman Islands.
4. The Company shall have and be capable of exercising all the functions of a natural person of full capacity irrespective of any question of corporate benefit as provided by the Companies Act.
5. The Company will not trade in the Cayman Islands with any person, firm or corporation except in furtherance of the business of the Company carried on outside the Cayman Islands; provided that nothing in this section shall be construed as to prevent the Company effecting and concluding contracts in the Cayman Islands, and exercising in the Cayman Islands all of its powers necessary for the carrying on of its business outside the Cayman Islands.
6. The liability of each Shareholder is limited to the amount, if any, unpaid on the Shares held by such Shareholder.
7. The authorised share capital of the Company is US\$50,000 divided into 2,500,000,000 ordinary shares of a par value of US\$[0.00002] each. Subject to the Companies Act and the Articles, the Company shall have power to redeem or purchase any of its Shares and to increase or reduce its authorised share capital and to sub-divide or consolidate the said Shares or any of them and to issue all or any part of its capital whether original, redeemed, increased or reduced with or without any preference, priority, special privilege or other rights or subject to any postponement of rights or to any conditions or restrictions whatsoever and so that unless the conditions of issue shall otherwise expressly provide every issue of shares whether stated to be ordinary, preference or otherwise shall be subject to the powers on the part of the Company hereinbefore provided.
8. The Company has the power contained in the Companies Act to deregister in the Cayman Islands and be registered by way of continuation in some other jurisdiction.
9. Capitalised terms that are not defined in this Memorandum of Association bear the same meanings as those given in the Articles of Association of the Company.



**THE COMPANIES ACT (AS REVISED)  
OF THE CAYMAN ISLANDS  
COMPANY LIMITED BY SHARES**

**SECOND AMENDED AND RESTATED  
ARTICLES OF ASSOCIATION  
OF  
YS Biopharma Co., Ltd**

(Adopted by a Special Resolution passed on [•] 2022 and effective on [•] 2022)

**TABLE A**

The regulations contained or incorporated in Table ‘A’ in the First Schedule of the Companies Act shall not apply to the Company and the following Articles shall comprise the Articles of Association of the Company.

**INTERPRETATION**

1. In these Articles the following defined terms will have the meanings ascribed to them, if not inconsistent with the subject or context:

<b>“Articles”</b>	means these articles of association of the Company, as from time to time altered or added to in accordance with the Companies Act and these Articles;
<b>“Board” and “Board of Directors” and “Directors”</b>	means the directors of the Company for the time being, or as the case may be, the directors assembled as a board or as a committee thereof;
<b>“Chairperson”</b>	means the chairperson of the Board of Directors;
<b>“Class” or “Classes”</b>	means any class or classes of Shares as may from time to time be issued by the Company;
<b>“Commission”</b>	means the Securities and Exchange Commission of the United States of America or any other federal agency for the time being administering the Securities Act;
<b>“Communications Facilities”</b>	means technology (including without limitation video, video-conferencing, internet or online conferencing applications, telephone or tele-conferencing and/or other video-communications, internet or online conferencing application or telecommunications facilities) by which natural persons are capable of hearing and being heard by each other;
<b>“Company”</b>	means <b>YS Biopharma Co., Ltd</b> , a Cayman Islands exempted company;
<b>“Companies Act”</b>	means the Companies Act (As Revised) of the Cayman Islands and any statutory amendment or re-enactment thereof;
<b>“Company’s Website”</b>	means the main corporate/investor relations website of the Company, the address or domain name of which has been disclosed in any registration statement filed by the Company with the Commission in connection with its initial public offering of Shares, or which has otherwise been notified to Shareholders;
<b>“Designated Stock Exchange”</b>	means the stock exchange in the United States on which any Shares are listed for trading;
<b>“Designated Stock Exchange Rules”</b>	means the relevant code, rules and regulations, as amended, from time to time, applicable as a result of the original and continued listing of any Shares on the Designated Stock Exchange;

<b>“electronic”</b>	has the meaning given to it in the Electronic Transactions Act and any amendment thereto or re-enactments thereof for the time being in force and includes every other law incorporated therewith or substituted therefor;
<b>“electronic communication”</b>	means electronic posting to the Company’s Website, transmission to any number, address or internet website or other electronic delivery methods as otherwise decided and approved by not less than two-thirds of the vote of the Board;
<b>“Electronic Transactions Act”</b>	means the Electronic Transactions Act (As Revised) of the Cayman Islands and any statutory amendment or re-enactment thereof;
<b>“electronic record”</b>	has the meaning given to it in the Electronic Transactions Act and any amendment thereto or re-enactments thereof for the time being in force and includes every other law incorporated therewith or substituted therefor;
<b>“Memorandum of Association”</b>	means the memorandum of association of the Company, as amended or substituted from time to time;
<b>“Ordinary Resolution”</b>	means a resolution: <ul style="list-style-type: none"> <li>(a) passed by a simple majority of the votes cast by such Shareholders as, being entitled to do so, vote in person or, where proxies are allowed, by proxy or, in the case of corporations, by their duly authorised representatives, at a general meeting of the Company held in accordance with these Articles; or</li> <li>(b) approved in writing by all of the Shareholders entitled to vote at a general meeting of the Company in one or more instruments each signed by one or more of the Shareholders and the effective date of the resolution so adopted shall be the date on which the instrument, or the last of such instruments, if more than one, is executed;</li> </ul>
<b>“Ordinary Shares”</b>	means the ordinary shares in the capital of the Company with a par value of US\$[0.00002] each;
<b>“paid up”</b>	means paid up as to the par value in respect of the issue of any Shares and includes credited as paid up;
<b>“Person”</b>	means any natural person, firm, company, joint venture, partnership, corporation, association or other entity (whether or not having a separate legal personality) or any of them as the context so requires;
<b>“Present”</b>	means, in respect of any Person, such Person’s presence at a general meeting of Shareholders (or any meeting of the holders of any Class of Shares), which may be satisfied by means of such Person or, if a corporation or other non-natural Person, its duly authorized representative (or, in the case of any Shareholder, a proxy which has been validly appointed by such Shareholder in accordance with these Articles), being: (a) physically present at the venue specified in the notice convening the meeting; or (b) in the case of any meeting at which Communications Facilities are permitted in accordance with these Articles, including any Virtual Meeting, connected by means of the use of such Communication Facilities in accordance with procedures specified in the notice convening such general meeting; and <b>“Presence”</b> shall be construed accordingly;

<b>“Register”</b>	means the register of Members of the Company maintained in accordance with the Companies Act;
<b>“Registered Office”</b>	means the registered office of the Company as required by the Companies Act;
<b>“Seal”</b>	means the common seal of the Company (if adopted) including any facsimile thereof;
<b>“Secretary”</b>	means any Person appointed by the Directors to perform any of the duties of the secretary of the Company;
<b>“Securities Act”</b>	means the Securities Act of 1933 of the United States of America, as amended, or any similar federal statute and the rules and regulations of the Commission thereunder, all as the same shall be in effect at the time;
<b>“Share”</b>	means a share in the capital of the Company. All references to “Shares” herein shall be deemed to be Shares of any or all Classes as the context may require. For the avoidance of doubt in these Articles the expression “Share” shall include a fraction of a Share;
<b>“Shareholder” or “Member”</b>	means a Person who is registered as the holder of one or more Shares in the Register;
<b>“Share Premium Account”</b>	means the share premium account established in accordance with these Articles and the Companies Act;
<b>“signed”</b>	means bearing a signature or representation of a signature affixed by mechanical means or an electronic symbol or process attached to or logically associated with an electronic communication and executed or adopted by a Person with the intent to sign the electronic communication;
<b>“Special Resolution”</b>	means a special resolution of the Company passed in accordance with the Companies Act, being a resolution: <ul style="list-style-type: none"> <li>(a) passed by not less than two-thirds of the votes cast by such Shareholders as, being entitled to do so, vote in person or, where proxies are allowed, by proxy or, in the case of corporations, by their duly authorised representatives, at a general meeting of the Company of which notice specifying the intention to propose the resolution as a special resolution has been duly given; or</li> <li>(b) approved in writing by all of the Shareholders entitled to vote at a general meeting of the Company in one or more instruments each signed by one or more of the Shareholders and the effective date of the special resolution so adopted shall be the date on which the instrument or the last of such instruments, if more than one, is executed;</li> </ul>
<b>“Treasury Share”</b>	means a Share held in the name of the Company as a treasury share in accordance with the Companies Act;
<b>“United States”</b>	means the United States of America, its territories, its possessions and all areas subject to its jurisdiction; and

**“Virtual Meeting”** means any general meeting of the Shareholders at which the Shareholders (and any other permitted participants of such meeting, including without limitation the chairperson of the meeting and any Directors) are permitted to be Present solely by means of Communications Facilities.

2. In these Articles, save where the context requires otherwise:
  - (a) words importing the singular number shall include the plural number and vice versa;
  - (b) words importing the masculine gender only shall include the feminine gender and any Person as the context may require;
  - (c) the word “may” shall be construed as permissive and the word “shall” shall be construed as imperative;
  - (d) reference to a dollar or dollars (or US\$) and to a cent or cents is reference to dollars and cents of the United States of America;
  - (e) reference to a statutory enactment shall include reference to any amendment or re-enactment thereof for the time being in force;
  - (f) reference to any determination by the Directors shall be construed as a determination by the Directors in their sole and absolute discretion and shall be applicable either generally or in any particular case;
  - (g) reference to “in writing” shall be construed as written or represented by any means reproducible in writing, including any form of print, lithograph, email, facsimile, photograph or telex or represented by any other substitute or format for storage or transmission for writing including in the form of an electronic record or partly one and partly another;
  - (h) any requirements as to delivery under the Articles include delivery in the form of an electronic record or an electronic communication;
  - (i) any requirements as to execution or signature under the Articles, including the execution of the Articles themselves, can be satisfied in the form of an electronic signature as defined in the Electronic Transaction Act; and
  - (j) Sections 8 and 19(3) of the Electronic Transactions Act shall not apply.
3. Subject to the last two preceding Articles, any words defined in the Companies Act shall, if not inconsistent with the subject or context, bear the same meaning in these Articles.

#### **PRELIMINARY**

4. The business of the Company may be conducted as the Directors see fit.
5. The Registered Office shall be at such address in the Cayman Islands as the Directors may from time to time determine. The Company may in addition establish and maintain such other offices and places of business and agencies in such places as the Directors may from time to time determine.
6. The expenses incurred in the formation of the Company and in connection with the offer for subscription and issue of Shares shall be paid by the Company. Such expenses may be amortised over such period as the Directors may determine and the amount so paid shall be charged against income and/or capital in the accounts of the Company as the Directors shall determine.
7. The Directors shall keep, or cause to be kept, the Register at such place as the Directors may from time to time determine and, in the absence of any such determination, the Register shall be kept at the Registered Office.

## SHARES

8. Subject to these Articles, all Shares for the time being unissued shall be under the control of the Directors who may, in their absolute discretion and without the approval of the Members, cause the Company to:
  - (a) issue, allot and dispose of Shares (including, without limitation, preferred shares) (whether in certificated form or non-certificated form) to such Persons, in such manner, on such terms and having such rights and being subject to such restrictions as they may from time to time determine;
  - (b) grant rights over Shares or other securities to be issued in one or more classes or series as they deem necessary or appropriate and determine the designations, powers, preferences, privileges and other rights attaching to such Shares or securities, including dividend rights, voting rights, conversion rights, terms of redemption and liquidation preferences, any or all of which may be greater than the powers, preferences, privileges and rights associated with the then issued and outstanding Shares, at such times and on such other terms as they think proper; and
  - (c) grant options with respect to Shares and issue warrants or similar instruments with respect thereto.
  
9. The Directors may authorise the division of Shares into any number of Classes and the different Classes shall be authorised, established and designated (or re-designated as the case may be) and the variations in the relative rights (including, without limitation, voting, dividend and redemption rights), restrictions, preferences, privileges and payment obligations as between the different Classes (if any) may be fixed and determined by the Directors or by an Ordinary Resolution. The Directors may issue Shares with such preferred or other rights, all or any of which may be greater than the rights of Ordinary Shares, at such time and on such terms as they may think appropriate. Notwithstanding Article 12, the Directors may issue from time to time, out of the authorised share capital of the Company (other than the authorised but unissued Ordinary Shares), series of preferred shares in their absolute discretion and without approval of the Members; provided, however, before any preferred shares of any such series are issued, the Directors shall by resolution of Directors determine, with respect to any series of preferred shares, the terms and rights of that series, including:
  - (a) the designation of such series, the number of preferred shares to constitute such series and the subscription price thereof if different from the par value thereof;
  - (b) whether the preferred shares of such series shall have voting rights, in addition to any voting rights provided by law, and, if so, the terms of such voting rights, which may be general or limited;
  - (c) the dividends, if any, payable on such series, whether any such dividends shall be cumulative, and, if so, from what dates, the conditions and dates upon which such dividends shall be payable, and the preference or relation which such dividends shall bear to the dividends payable on any shares of any other class or any other series of shares;
  - (d) whether the preferred shares of such series shall be subject to redemption by the Company, and, if so, the times, prices and other conditions of such redemption;
  - (e) whether the preferred shares of such series shall have any rights to receive any part of the assets available for distribution amongst the Members upon the liquidation of the Company, and, if so, the terms of such liquidation preference, and the relation which such liquidation preference shall bear to the entitlements of the holders of shares of any other class or any other series of shares;
  - (f) whether the preferred shares of such series shall be subject to the operation of a retirement or sinking fund and, if so, the extent to and manner in which any such retirement or sinking fund shall be applied to the purchase or redemption of the preferred shares of such series for retirement or other corporate purposes and the terms and provisions relative to the operation thereof;
  - (g) whether the preferred shares of such series shall be convertible into, or exchangeable for, shares of any other class or any other series of preferred shares or any other securities and, if so, the price or prices or the rate or rates of conversion or exchange and the method, if any, of adjusting the same, and any other terms and conditions of conversion or exchange;

- (h) the limitations and restrictions, if any, to be effective while any preferred shares of such series are outstanding upon the payment of dividends or the making of other distributions on, and upon the purchase, redemption or other acquisition by the Company of, the existing shares or shares of any other class of shares or any other series of preferred shares;
- (i) the conditions or restrictions, if any, upon the creation of indebtedness of the Company or upon the issue of any additional shares, including additional shares of such series or of any other class of shares or any other series of preferred shares; and
- (j) any other powers, preferences and relative, participating, optional and other special rights, and any qualifications, limitations and restrictions thereof;

and, for such purposes, the Directors may reserve an appropriate number of Shares for the time being unissued. The Company shall not issue Shares to bearer.

10. The Company may insofar as may be permitted by law, pay a commission to any Person in consideration of his subscribing or agreeing to subscribe whether absolutely or conditionally for any Shares. Such commissions may be satisfied by the payment of cash or the lodgement of fully or partly paid-up Shares or partly in one way and partly in the other. The Company may also pay such brokerage as may be lawful on any issue of Shares.
11. The Directors may refuse to accept any application for Shares, and may accept any application in whole or in part, for any reason or for no reason.

#### **MODIFICATION OF RIGHTS**

12. Whenever the capital of the Company is divided into different Classes the rights attached to any such Class may, subject to any rights or restrictions for the time being attached to any Class, only be materially adversely varied with the consent in writing of the holders of two-thirds of the issued Shares of that Class or with the sanction of a Special Resolution passed at a separate meeting of the holders of the Shares of that Class. To every such separate meeting all the provisions of these Articles relating to general meetings of the Company or to the proceedings thereat shall, *mutatis mutandis*, apply, except that the necessary quorum shall be one or more Persons holding or representing by proxy at least one-third in nominal or par value amount of the issued Shares of the relevant Class (but so that if at any adjourned meeting of such holders a quorum as above defined is not present, those Shareholders who are present shall form a quorum) and that, subject to any rights or restrictions for the time being attached to the Shares of that Class, every Shareholder of the Class shall on a poll have one vote for each Share of the Class held by him. For the purposes of this Article the Directors may treat all the Classes or any two or more Classes as forming one Class if they consider that all such Classes would be affected in the same way by the proposals under consideration, but in any other case shall treat them as separate Classes.
13. The rights conferred upon the holders of the Shares of any Class issued with preferred or other rights shall not, subject to any rights or restrictions for the time being attached to the Shares of that Class, be deemed to be materially adversely varied by, inter alia, the creation, allotment or issue of further Shares ranking *pari passu* with or subsequent to them or the redemption or purchase of any Shares of any Class by the Company. The rights of the holders of Shares shall not be deemed to be materially adversely varied by the creation or issue of Shares with preferred or other rights including, without limitation, the creation of Shares with enhanced or weighted voting rights.

#### **CERTIFICATES**

14. Every Person whose name is entered as a Member in the Register may, without payment and upon its written request, request a certificate within two calendar months after allotment or lodgment of transfer (or within such other period as the conditions of issue shall provide) in the form determined by the Directors. All certificates shall specify the Share or Shares held by that Person, provided that in respect of a Share or Shares held jointly by several Persons the Company shall not be bound to issue more than one certificate, and delivery of a certificate for a Share to one of several joint holders shall be sufficient delivery to all. All certificates for Shares shall be delivered personally or sent through the post addressed to the Member entitled thereto at the Member's registered address as appearing in the Register.

15. Every share certificate of the Company shall bear legends required under the applicable laws, including the Securities Act.
16. Any two or more certificates representing Shares of any one Class held by any Member may at the Member's request be cancelled and a single new certificate for such Shares issued in lieu on payment (if the Directors shall so require) of one dollar (US\$1.00) or such smaller sum as the Directors shall determine.
17. If a share certificate shall be damaged or defaced or alleged to have been lost, stolen or destroyed, a new certificate representing the same Shares may be issued to the relevant Member upon request, subject to delivery up of the old certificate or (if alleged to have been lost, stolen or destroyed) compliance with such conditions as to evidence and indemnity and the payment of out-of-pocket expenses of the Company in connection with the request as the Directors may think fit.
18. In the event that Shares are held jointly by several Persons, any request may be made by any one of the joint holders and if so made shall be binding on all of the joint holders.

#### **FRACTIONAL SHARES**

19. The Directors may issue fractions of a Share and, if so issued, a fraction of a Share shall be subject to and carry the corresponding fraction of liabilities (whether with respect to nominal or par value, premium, contributions, calls or otherwise), limitations, preferences, privileges, qualifications, restrictions, rights (including, without prejudice to the generality of the foregoing, voting and participation rights) and other attributes of a whole Share. If more than one fraction of a Share of the same Class is issued to or acquired by the same Shareholder such fractions shall be accumulated.

#### **LIEN**

20. The Company has a first and paramount lien on every Share (whether or not fully paid) for all amounts (whether presently payable or not) payable at a fixed time or called in respect of that Share. The Company also has a first and paramount lien on every Share registered in the name of a Person indebted or under liability to the Company (whether he is the sole registered holder of a Share or one of two or more joint holders) for all amounts owing by him or his estate to the Company (whether or not presently payable). The Directors may at any time declare a Share to be wholly or in part exempt from the provisions of this Article. The Company's lien on a Share extends to any amount payable in respect of it, including but not limited to dividends.
21. The Company may sell, in such manner as the Directors in their absolute discretion think fit, any Share on which the Company has a lien, but no sale shall be made unless an amount in respect of which the lien exists is presently payable nor until the expiration of fourteen calendar days after a notice in writing, demanding payment of such part of the amount in respect of which the lien exists as is presently payable, has been given to the registered holder for the time being of the Share, or the Persons entitled thereto by reason of his death or bankruptcy.
22. For giving effect to any such sale the Directors may authorise a Person to transfer the Shares sold to the purchaser thereof. The purchaser shall be registered as the holder of the Shares comprised in any such transfer and he shall not be bound to see to the application of the purchase money, nor shall his title to the Shares be affected by any irregularity or invalidity in the proceedings in reference to the sale.
23. The proceeds of the sale after deduction of expenses, fees and commissions incurred by the Company shall be received by the Company and applied in payment of such part of the amount in respect of which the lien exists as is presently payable, and the residue shall (subject to a like lien for sums not presently payable as existed upon the Shares prior to the sale) be paid to the Person entitled to the Shares immediately prior to the sale.

#### **CALLS ON SHARES**

24. Subject to the terms of the allotment, the Directors may from time to time make calls upon the Shareholders in respect of any moneys unpaid on their Shares, and each Shareholder shall (subject to

receiving at least fourteen calendar days' notice specifying the time or times of payment) pay to the Company at the time or times so specified the amount called on such Shares. A call shall be deemed to have been made at the time when the resolution of the Directors authorising such call was passed.

25. The joint holders of a Share shall be jointly and severally liable to pay calls in respect thereof.
26. If a sum called in respect of a Share is not paid before or on the day appointed for payment thereof, the Person from whom the sum is due shall pay interest upon the sum at the rate of eight percent per annum from the day appointed for the payment thereof to the time of the actual payment, but the Directors shall be at liberty to waive payment of that interest wholly or in part.
27. The provisions of these Articles as to the liability of joint holders and as to payment of interest shall apply in the case of non-payment of any sum which, by the terms of issue of a Share, becomes payable at a fixed time, whether on account of the amount of the Share, or by way of premium, as if the same had become payable by virtue of a call duly made and notified.
28. The Directors may make arrangements with respect to the issue of partly paid Shares for a difference between the Shareholders, or the particular Shares, in the amount of calls to be paid and in the times of payment.
29. The Directors may, if they think fit, receive from any Shareholder willing to advance the same all or any part of the moneys uncalled and unpaid upon any partly paid Shares held by him, and upon all or any of the moneys so advanced may (until the same would, but for such advance, become presently payable) pay interest at such rate (not exceeding without the sanction of an Ordinary Resolution, eight percent per annum) as may be agreed upon between the Shareholder paying the sum in advance and the Directors. No such sum paid in advance of calls shall entitle the Member paying such sum to any portion of a dividend declared in respect of any period prior to the date upon which such sum would, but for such payment, become presently payable.

#### **FORFEITURE OF SHARES**

30. If a Shareholder fails to pay any call or instalment of a call in respect of partly paid Shares on the day appointed for payment, the Directors may, at any time thereafter during such time as any part of such call or instalment remains unpaid, serve a notice on him requiring payment of so much of the call or instalment as is unpaid, together with any interest which may have accrued.
31. The notice shall name a further day (not earlier than the expiration of fourteen calendar days from the date of the notice) on or before which the payment required by the notice is to be made, and shall state that in the event of non-payment at or before the time appointed, the Shares in respect of which the call was made will be liable to be forfeited.
32. If the requirements of any such notice as aforesaid are not complied with, any Share in respect of which the notice has been given may at any time thereafter, before the payment required by notice has been made, be forfeited by a resolution of the Directors to that effect.
33. A forfeited Share may be sold or otherwise disposed of on such terms and in such manner as the Directors think fit, and at any time before a sale or disposition the forfeiture may be cancelled on such terms as the Directors think fit.
34. A Person whose Shares have been forfeited shall cease to be a Shareholder in respect of the forfeited Shares, but shall, notwithstanding, remain liable to pay to the Company all moneys which at the date of forfeiture were payable by him to the Company in respect of the Shares forfeited, but his liability shall cease if and when the Company receives payment in full of the amount unpaid on the Shares forfeited.
35. A certificate in writing under the hand of a Director that a Share has been duly forfeited on a date stated in the certificate shall be conclusive evidence of the facts in the declaration as against all Persons claiming to be entitled to the Share.
36. The Company may receive the consideration, if any, given for a Share on any sale or disposition thereof pursuant to the provisions of these Articles as to forfeiture and may execute a transfer of the Share in



favour of the Person to whom the Share is sold or disposed of and that Person shall be registered as the holder of the Share and shall not be bound to see to the application of the purchase money, if any, nor shall his title to the Shares be affected by any irregularity or invalidity in the proceedings in reference to the disposition or sale.

37. The provisions of these Articles as to forfeiture shall apply in the case of non-payment of any sum which by the terms of issue of a Share becomes due and payable, whether on account of the amount of the Share, or by way of premium, as if the same had been payable by virtue of a call duly made and notified.

#### **TRANSFER OF SHARES**

38. Subject to these Articles and the rules or regulations of the Designated Stock Exchange or any relevant securities laws, any Shareholder may transfer all or any Shares by an instrument of transfer. The instrument of transfer of any Share shall be in writing and in any usual or common form or such other form as the Directors may, in their absolute discretion, approve and be executed by or on behalf of the transferor and if in respect of a nil or partly paid up Share, or if so required by the Directors, shall also be executed on behalf of the transferee and shall be accompanied by the certificate (if any) of the Shares to which it relates and such other evidence as the Directors may reasonably require to show the right of the transferor to make the transfer. The transferor shall be deemed to remain a Shareholder until the name of the transferee is entered in the Register in respect of the relevant Shares.
39. (a) The Directors may in their absolute discretion decline to register any transfer of Shares which is not fully paid up or on which the Company has a lien.
- (b) The Directors may also decline to register any transfer of any Share unless:
- (i) the instrument of transfer is lodged with the Company, accompanied by the certificate for the Shares to which it relates and such other evidence as the Board may reasonably require to show the right of the transferor to make the transfer;
  - (ii) the instrument of transfer is in respect of only one Class of Shares;
  - (iii) the instrument of transfer is properly stamped, if required;
  - (iv) in the case of a transfer to joint holders, the number of joint holders to whom the Share is to be transferred does not exceed four; and
  - (v) a fee of such maximum sum as the Designated Stock Exchange may determine to be payable, or such lesser sum as the Board of Directors may from time to time require, is paid to the Company in respect thereof.
40. The registration of transfers may, on ten calendar days' notice being given by advertisement in such one or more newspapers, by electronic means or by any other means in accordance with the Designated Stock Exchange Rules, be suspended and the Register closed at such times and for such periods as the Directors may, in their absolute discretion, from time to time determine, provided always that such registration of transfer shall not be suspended nor the Register closed for more than thirty calendar days in any calendar year.
41. All instruments of transfer that are registered shall be retained by the Company. If the Directors refuse to register a transfer of any Shares, they shall within three calendar months after the date on which the transfer was lodged with the Company send notice of the refusal to each of the transferor and the transferee.

#### **TRANSMISSION OF SHARES**

42. The legal personal representative of a deceased sole holder of a Share shall be the only Person recognised by the Company as having any title to the Share. In the case of a Share registered in the name of two or more holders, the survivors or survivor, or the legal personal representatives of the deceased survivor, shall be the only Person recognised by the Company as having any title to the Share.

43. Any Person becoming entitled to a Share in consequence of the death or bankruptcy of a Shareholder shall, upon such evidence being produced as may from time to time be required by the Directors, have the right either to be registered as a Shareholder in respect of the Share or, instead of being registered himself, to make such transfer of the Share as the deceased or bankrupt Person could have made; but the Directors shall, in either case, have the same right to decline or suspend registration as they would have had in the case of a transfer of the Share by the deceased or bankrupt Person before the death or bankruptcy.
44. A Person becoming entitled to a Share by reason of the death or bankruptcy of a Shareholder shall be entitled to the same dividends and other advantages to which he would be entitled if he were the registered Shareholder, except that he shall not, before being registered as a Shareholder in respect of the Share, be entitled in respect of it to exercise any right conferred by membership in relation to meetings of the Company, provided however, that the Directors may at any time give notice requiring any such Person to elect either to be registered himself or to transfer the Share, and if the notice is not complied with within ninety calendar days, the Directors may thereafter withhold payment of all dividends, bonuses or other monies payable in respect of the Share until the requirements of the notice have been complied with.

#### **REGISTRATION OF EMPOWERING INSTRUMENTS**

45. The Company shall be entitled to charge a fee not exceeding one U.S. dollar (US\$1.00) on the registration of every probate, letters of administration, certificate of death or marriage, power of attorney, notice in lieu of distringas, or other instrument.

#### **ALTERATION OF SHARE CAPITAL**

46. The Company may from time to time by Ordinary Resolution increase the share capital by such sum, to be divided into Shares of such Classes and amount, as the resolution shall prescribe.
47. The Company may by Ordinary Resolution:
- (a) increase its share capital by new Shares of such amount as it thinks expedient;
  - (b) consolidate and divide all or any of its share capital into Shares of a larger amount than its existing Shares;
  - (c) subdivide its Shares, or any of them, into Shares of an amount smaller than that fixed by the Memorandum, provided that in the subdivision the proportion between the amount paid and the amount, if any, unpaid on each reduced Share shall be the same as it was in case of the Share from which the reduced Share is derived; and
  - (d) cancel any Shares that, at the date of the passing of the resolution, have not been taken or agreed to be taken by any Person and diminish the amount of its share capital by the amount of the Shares so cancelled.
48. The Company may by Special Resolution reduce its share capital and any capital redemption reserve in any manner authorised by the Companies Act.

#### **REDEMPTION, PURCHASE AND SURRENDER OF SHARES**

49. Subject to the provisions of the Companies Act and these Articles, the Company may:
- (a) issue Shares that are to be redeemed or are liable to be redeemed at the option of the Shareholder or the Company. The redemption of Shares shall be effected in such manner and upon such terms as may be determined, before the issue of such Shares, by either the Board or by the Shareholders by Special Resolution;
  - (b) purchase its own Shares (including any redeemable Shares) on such terms and in such manner and terms as have been approved by the Board or by the Shareholders by Ordinary Resolution, or are otherwise authorised by these Articles; and
  - (c) make a payment in respect of the redemption or purchase of its own Shares in any manner permitted by the Companies Act, including out of capital.

50. The purchase of any Share shall not oblige the Company to purchase any other Share other than as may be required pursuant to applicable law and any other contractual obligations of the Company.
51. The holder of the Shares being purchased shall be bound to deliver up to the Company the certificate(s) (if any) thereof for cancellation and thereupon the Company shall pay to him the purchase or redemption monies or consideration in respect thereof.
52. The Directors may accept the surrender for no consideration of any fully paid Share.

#### **TREASURY SHARES**

53. The Directors may, prior to the purchase, redemption or surrender of any Share, determine that such Share shall be held as a Treasury Share.
54. The Directors may determine to cancel a Treasury Share or transfer a Treasury Share on such terms as they think proper (including, without limitation, for nil consideration).

#### **GENERAL MEETINGS**

55. All general meetings other than annual general meetings shall be called extraordinary general meetings.
56. (a) The Company may (but shall not be obliged to) in each calendar year hold a general meeting as its annual general meeting and shall specify the meeting as such in the notices calling it. The annual general meeting shall be held at such time and place as may be determined by the Directors.
  - (b) At these meetings the report of the Directors (if any) shall be presented.
57. (a) The Chairperson or a majority of the Directors (acting by a resolution of the Board) may call general meetings, and they shall on a Shareholders' requisition forthwith proceed to convene an extraordinary general meeting of the Company.
  - (b) A Shareholders' requisition is a requisition of Members holding at the date of deposit of the requisition Shares which carry in aggregate not less than 10% of all votes attaching to all issued and outstanding Shares of the Company that as at the date of the deposit carry the right to vote at general meetings of the Company.
  - (c) The requisition must state the objects of the meeting and must be signed by the requisitionists and deposited at the Registered Office, and may consist of several documents in like form each signed by one or more requisitionists.
  - (d) If there are no Directors as at the date of the deposit of the Shareholders' requisition, or if the Directors do not within twenty-one calendar days from the date of the deposit of the requisition duly proceed to convene a general meeting to be held within a further twenty-one calendar days, the requisitionists, or any of them representing more than one-half of the total voting rights of all of them, may themselves convene a general meeting, but any meeting so convened shall not be held after the expiration of three calendar months after the expiration of the said twenty-one calendar days.
  - (e) A general meeting convened as aforesaid by requisitionists shall be convened in the same manner as nearly as possible as that in which general meetings are to be convened by Directors.

#### **NOTICE OF GENERAL MEETINGS**

58. At least seven calendar days' notice shall be given for any general meeting. Every notice shall be exclusive of the day on which it is given or deemed to be given and of the day for which it is given and shall specify the place (except in the case of a Virtual Meeting), the day and the hour of the meeting and the general nature of the business and shall be given in the manner hereinafter mentioned or in such other manner if any as may be prescribed by the Company, provided that a general meeting of the Company shall, whether or not the notice specified in this Article has been given and whether or not the provisions of these Articles regarding general meetings have been complied with, be deemed to have been duly convened if it

is so agreed by the holders of two-thirds (2/3rd) of the Shareholders having the right to attend and vote at the meeting, Present at the meeting.

59. The accidental omission to give notice of a meeting to or the non-receipt of a notice of a meeting by any Shareholder shall not invalidate the proceedings at any meeting.

#### **PROCEEDINGS AT GENERAL MEETINGS**

60. No business except for the appointment of a chairperson for the meeting shall be transacted at any general meeting unless a quorum of Shareholders is Present at the time when the meeting proceeds to business. One or more Shareholders holding Shares which carry in aggregate (or representing by proxy) not less than one-third of all votes attaching to all Shares in issue and entitled to vote at such general meeting, Present at the meeting, shall be a quorum for all purposes.
61. If within half an hour from the time appointed for the meeting a quorum is not Present, the meeting shall be dissolved.
62. If the Directors so determine in respect of a specific general meeting or all general meetings of the Company, Presence at the relevant general meeting may be by means of Communications Facilities. The Directors may determine that any general meeting may be held as a Virtual Meeting. The notice of any general meeting at which Communications Facilities may be utilized (including any Virtual Meeting) must disclose the Communications Facilities that will be used, including the procedures to be followed by any Shareholder or other participant of the general meeting utilizing such Communications Facilities.
63. The Chairperson, if any, shall preside as chairperson at every general meeting of the Company.
64. If there is no such Chairperson, or if at any general meeting he is not Present within fifteen minutes after the time appointed for holding the meeting or is unwilling to act as chairperson of the meeting, any Director or Person nominated by the Directors shall preside as chairperson of that meeting, failing which the Shareholders Present shall choose any Person Present to be chairperson of that meeting.
65. The chairperson of any general meeting (including any Virtual Meeting) shall be entitled to attend and participate at any such general meeting by means of Communication Facilities, and to act as the chairperson of such general meeting, in which event the following provisions shall apply:
- (a) the chairperson shall be deemed to be Present at the general meeting; and
  - (b) if the Communication Facilities are interrupted or fail for any reason to enable the chairperson of the general meeting to hear and be heard by all other Persons participating in the meeting, then the other Directors Present at the general meeting shall choose another Director Present to act as chairperson of the general meeting for (or for the remainder of) the general meeting; provided that if no other Director is Present at the general meeting, or if all the Directors Present decline to take the chair, then the general meeting shall be automatically adjourned to the same day in the next week and at such time and place as shall be decided by the Directors.
66. The chairperson of any general meeting at which a quorum is Present may with the consent of the meeting (and shall if so directed by the meeting) adjourn the meeting from time to time and from place to place, but no business shall be transacted at any adjourned meeting other than the business left unfinished at the meeting from which the adjournment took place. When a meeting, or adjourned meeting, is adjourned for fourteen calendar days or more, notice of the adjourned meeting shall be given as in the case of an original meeting. Save as aforesaid it shall not be necessary to give any notice of an adjournment or of the business to be transacted at an adjourned meeting.
67. The Directors may cancel or postpone any duly convened general meeting at any time prior to such meeting, except for general meetings requisitioned by the Shareholders in accordance with these Articles, for any reason or for no reason, upon notice in writing to Shareholders. A postponement may be for a stated period of any length or indefinitely as the Directors may determine.
68. At any general meeting a resolution put to the vote of the meeting shall be decided on a show of hands, unless a poll is (before or on the declaration of the result of the show of hands) demanded by the

chairperson of the meeting or any Shareholder holding not less than ten per cent (10%) of the votes attaching to the Shares Present, and unless a poll is so demanded, a declaration by the chairperson of the meeting that a resolution has, on a show of hands, been carried, or carried unanimously, or by a particular majority, or lost, and an entry to that effect in the book of the proceedings of the Company, shall be conclusive evidence of the fact, without proof of the number or proportion of the votes recorded in favour of, or against, that resolution.

69. If a poll is duly demanded it shall be taken in such manner as the chairperson of the meeting directs, and the result of the poll shall be deemed to be the resolution of the meeting at which the poll was demanded.
70. All questions submitted to a meeting shall be decided by an Ordinary Resolution except where a greater majority is required by these Articles or by the Companies Act. In the case of an equality of votes, whether on a show of hands or on a poll, the chairperson of the meeting at which the show of hands takes place or at which the poll is demanded, shall be entitled to a second or casting vote.
71. A poll demanded on the election of a chairperson of the meeting or on a question of adjournment shall be taken forthwith. A poll demanded on any other question shall be taken at such time as the chairperson of the meeting directs.

#### VOTES OF SHAREHOLDERS

72. Subject to any rights and restrictions for the time being attached to any Share, at a general meeting of the Company, (i) on a show of hands, every Shareholder Present at the meeting shall have one vote, and (ii) on a poll, every Shareholder Present at the meeting shall have one (1) vote for each Ordinary Share of which such Shareholder is the holder. On a poll a Shareholder entitled to more than one vote is under no obligation to cast all his or her votes in the same way. For the avoidance of doubt, where more than one proxy is appointed by any Shareholder, each such proxy is under no obligation to cast all his or her votes in the same way on a poll.
73. In the case of joint holders the vote of the senior who tenders a vote whether in person or by proxy (or, if a corporation or other non-natural person, by its duly authorised representative or proxy) shall be accepted to the exclusion of the votes of the other joint holders and for this purpose seniority shall be determined by the order in which the names stand in the Register.
74. Shares carrying the right to vote that are held by a Shareholder of unsound mind, or in respect of whom an order has been made by any court having jurisdiction in lunacy, may be voted, whether on a show of hands or on a poll, by his committee, or other Person in the nature of a committee appointed by that court, and any such committee or other Person may vote in respect of such Shares by proxy.
75. No Shareholder shall be entitled to vote at any general meeting of the Company unless all calls, if any, or other sums presently payable by him in respect of Shares carrying the right to vote held by him have been paid.
76. On a poll votes may be given either personally or by proxy.
77. A Shareholder entitled to attend and vote at a general meeting of the Company shall be entitled to appoint another person (who must be an individual) as their proxy to attend and vote instead of them. The instrument appointing a proxy shall be in writing under the hand of the appointor or of his attorney duly authorised in writing or, if the appointor is a corporation, either under Seal or under the hand of an officer or attorney duly authorised. A proxy need not be a Shareholder. A Shareholder may appoint any number of proxies to attend in their stead at any one general meeting or at any one class meeting.
78. An instrument appointing a proxy may be in any usual or common form or such other form as the Directors may approve.
79. The instrument appointing a proxy shall be deposited at the Registered Office or at such other place as is specified for that purpose in the notice convening the meeting, or in any instrument of proxy sent out by the Company:

- (a) not less than 48 hours before the time for holding the meeting or adjourned meeting at which the person named in the instrument proposes to vote; or
- (b) in the case of a poll taken more than 48 hours after it is demanded, be deposited as aforesaid after the poll has been demanded and not less than 24 hours before the time appointed for the taking of the poll; or
- (c) where the poll is not taken forthwith but is taken not more than 48 hours after it was demanded be delivered at the meeting at which the poll was demanded to the chairperson of the meeting or to the secretary or to any Director;

provided that the Directors may in the notice convening the meeting, or in an instrument of proxy sent out by the Company, direct that the instrument appointing a proxy may be deposited at such other time (no later than the time for holding the meeting or adjourned meeting) at the Registered Office or at such other place as is specified for that purpose in the notice convening the meeting, or in any instrument of proxy sent out by the Company. The chairperson of the meeting may in any event at his discretion direct that an instrument of proxy shall be deemed to have been duly deposited. An instrument of proxy that is not deposited in the manner permitted shall be invalid.

- 80. The instrument appointing a proxy shall be deemed to confer authority to demand or join in demanding a poll.
- 81. A resolution in writing signed by all the Shareholders for the time being entitled to receive notice of and to attend and vote at general meetings of the Company (or being corporations by their duly authorised representatives) shall be as valid and effective as if the same had been passed at a general meeting of the Company duly convened and held.

#### **CORPORATIONS ACTING BY REPRESENTATIVES AT MEETINGS**

- 82. Any corporation which is a Shareholder or a Director may by resolution of its directors or other governing body authorise such Person as it thinks fit to act as its representative at any meeting of the Company or of any meeting of holders of a Class or of the Directors or of a committee of Directors, and the Person so authorised shall be entitled to exercise the same powers on behalf of the corporation which he represents as that corporation could exercise if it were an individual Shareholder or Director.

#### **CLEARING HOUSES**

- 83. If a recognised clearing house (or its nominee(s)) is a Member of the Company it may, by resolution of its directors or other governing body or by power of attorney, authorise such Person(s) as it thinks fit to act as its representative(s) at any general meeting of the Company or of any Class of Shareholders provided that, if more than one Person is so authorised, the authorisation shall specify the number and Class of Shares in respect of which each such Person is so authorised. A Person so authorised pursuant to this Article shall be entitled to exercise the same powers on behalf of the recognised clearing house (or its nominee(s)) which he represents as that recognised clearing house (or its nominee(s)) could exercise if it were an individual Member holding the number and Class of Shares specified in such authorisation, including the right to vote individually on a show of hands.

#### **DIRECTORS**

- 84. Unless otherwise determined by the Company in general meeting, the number of Directors shall not be less than three (3) Directors.
- 85. All Directors shall hold office until the expiration of their respective terms of office and until their successors shall have been appointed and qualified. A Director appointed to fill a vacancy resulting from the death, resignation or removal of a Director shall serve for the remainder of the full term of the Director whose death, resignation or removal shall have created such vacancy and until his successor shall have been appointed and qualified.
- 86. The Company may by Ordinary Resolution appoint any person to be a Director.

87. The Board may, by the affirmative vote of a simple majority of the remaining Directors present and voting at a Board meeting, appoint any person as a Director, to fill a casual vacancy on the Board or as an addition to the existing Board.
88. A Director may be removed from office by Ordinary Resolution (except with regard to the removal of the Chairperson, who may be removed from office by Special Resolution). A vacancy on the Board created by the removal of a Director under the previous sentence may be filled by Ordinary Resolution or by the affirmative vote of a simple majority of the remaining Directors present and voting at a Board meeting. The notice of any meeting at which a resolution to remove a Director shall be proposed or voted upon must contain a statement of the intention to remove that Director and such notice must be served on that Director not less than ten (10) calendar days before the meeting. Such Director is entitled to attend the meeting and be heard on the motion for his removal.
89. An appointment of a Director may be on terms that the Director shall automatically retire from office (unless he has sooner vacated office) at the next or a subsequent annual general meeting or upon any specified event or after any specified period in a written agreement between the Company and the Director, if any; but no such term shall be implied in the absence of express provision. Any Director whose term of office expires shall be eligible for re-election at a meeting of the Shareholders or re-appointment by the Board.
90. The Board of Directors shall elect and appoint a Chairperson by a majority of the Directors then in office. The period for which the Chairperson will hold office will also be determined by a majority of all of the Directors then in office. The Chairperson shall preside as chairperson at every meeting of the Board of Directors. To the extent the Chairperson is not present at a meeting of the Board of Directors within fifteen minutes after the time appointed for holding the same, the attending Directors may choose one of their number to be the chairperson of the meeting.
91. The Board may, from time to time, and except as required by applicable law or Designated Stock Exchange Rules, adopt, institute, amend, modify or revoke the corporate governance policies or initiatives of the Company and determine on various corporate governance related matters of the Company as the Board shall determine by resolution of Directors from time to time.
92. A Director shall not be required to hold any Shares in the Company by way of qualification. A Director who is not a Member of the Company shall nevertheless be entitled to attend and speak at general meetings.
93. The remuneration of the Directors may be determined by the Directors.
94. The Directors shall be entitled to be paid for their travelling, hotel and other expenses properly incurred by them in going to, attending and returning from meetings of the Directors, or any committee of the Directors, or general meetings of the Company, or otherwise in connection with the business of the Company, or to receive such fixed allowance in respect thereof as may be determined by the Directors from time to time, or a combination partly of one such method and partly the other.

#### **ALTERNATE DIRECTOR OR PROXY**

95. Any Director may in writing appoint another Person to be his alternate and, save to the extent provided otherwise in the form of appointment, such alternate shall have authority to sign written resolutions on behalf of the appointing Director, but shall not be required to sign such written resolutions where they have been signed by the appointing director, and to act in such Director's place at any meeting of the Directors at which the appointing Director is unable to be present. Every such alternate shall be entitled to attend and vote at meetings of the Directors as a Director when the Director appointing him is not personally present and where he is a Director to have a separate vote on behalf of the Director he is representing in addition to his own vote. A Director may at any time in writing revoke the appointment of an alternate appointed by him. Such alternate shall be deemed for all purposes to be a Director and shall not be deemed to be the agent of the Director appointing him. The remuneration of such alternate shall be payable out of the remuneration of the Director appointing him and the proportion thereof shall be agreed between them.

96. Any Director may appoint any Person, whether or not a Director, to be the proxy of that Director to attend and vote on his behalf, in accordance with instructions given by that Director, or in the absence of such instructions at the discretion of the proxy, at a meeting or meetings of the Directors which that Director is unable to attend personally. The instrument appointing the proxy shall be in writing under the hand of the appointing Director and shall be in any usual or common form or such other form as the Directors may approve, and must be lodged with the chairperson of the meeting of the Directors at which such proxy is to be used, or first used, prior to the commencement of the meeting.

#### POWERS AND DUTIES OF DIRECTORS

97. Subject to the Companies Act, these Articles and to any resolutions passed in a general meeting, the business of the Company shall be managed by the Directors, who may pay all expenses incurred in setting up and registering the Company and may exercise all powers of the Company. No resolution passed by the Company in general meeting shall invalidate any prior act of the Directors that would have been valid if that resolution had not been passed.
98. Subject to these Articles, the Directors may from time to time appoint any natural person or corporation, whether or not a Director to hold such office in the Company as the Directors may think necessary for the administration of the Company, including but not limited to, chief executive officer, one or more other executive officers, president, one or more vice presidents, treasurer, assistant treasurer, manager or controller, and for such term and at such remuneration (whether by way of salary or commission or participation in profits or partly in one way and partly in another), and with such powers and duties as the Directors may think fit. Any natural person or corporation so appointed by the Directors may be removed by the Directors. The Directors may also appoint one or more of their number to the office of managing director upon like terms, but any such appointment shall ipso facto terminate if any managing director ceases for any cause to be a Director, or if the Company by Ordinary Resolution resolves that his tenure of office be terminated.
99. The Directors may appoint any natural person or corporation to be a Secretary (and if need be an assistant Secretary or assistant Secretaries) who shall hold office for such term, at such remuneration and upon such conditions and with such powers as they think fit. Any Secretary or assistant Secretary so appointed by the Directors may be removed by the Directors.
100. The Directors may delegate any of their powers to committees consisting of such member or members of their body as they think fit; any committee so formed shall in the exercise of the powers so delegated conform to any regulations that may be imposed on it by the Directors.
101. The Directors may from time to time and at any time by power of attorney (whether under Seal or under hand) or otherwise appoint any company, firm or Person or body of Persons, whether nominated directly or indirectly by the Directors, to be the attorney or attorneys or authorised signatory (any such person being an "Attorney" or "Authorised Signatory", respectively) of the Company for such purposes and with such powers, authorities and discretion (not exceeding those vested in or exercisable by the Directors under these Articles) and for such period and subject to such conditions as they may think fit, and any such power of attorney or other appointment may contain such provisions for the protection and convenience of Persons dealing with any such Attorney or Authorised Signatory as the Directors may think fit, and may also authorise any such Attorney or Authorised Signatory to delegate all or any of the powers, authorities and discretion vested in him.
102. The Directors may from time to time provide for the management of the affairs of the Company in such manner as they shall think fit and the provisions contained in the three next following Articles shall not limit the general powers conferred by this Article.
103. The Directors from time to time and at any time may establish any committees, local boards or agencies for managing any of the affairs of the Company and may appoint any natural person or corporation to be a member of such committees or local boards and may appoint any managers or agents of the Company and may fix the remuneration of any such natural person or corporation.



104. The Directors from time to time and at any time may delegate to any such committee, local board, manager or agent any of the powers, authorities and discretions for the time being vested in the Directors and may authorise the members for the time being of any such local board, or any of them to fill any vacancies therein and to act notwithstanding vacancies and any such appointment or delegation may be made on such terms and subject to such conditions as the Directors may think fit and the Directors may at any time remove any natural person or corporation so appointed and may annul or vary any such delegation, but no Person dealing in good faith and without notice of any such annulment or variation shall be affected thereby.
105. Any such delegates as aforesaid may be authorised by the Directors to sub-delegate all or any of the powers, authorities, and discretion for the time being vested in them.

#### **BORROWING POWERS OF DIRECTORS**

106. The Directors may from time to time at their discretion exercise all the powers of the Company to raise or borrow money and to mortgage or charge its undertaking, property and assets (present and future) and uncalled capital or any part thereof, to issue debentures, debenture stock, bonds and other securities, whether outright or as collateral security for any debt, liability or obligation of the Company or of any third party.

#### **THE SEAL**

107. The Seal shall not be affixed to any instrument except by the authority of a resolution of the Directors provided always that such authority may be given prior to or after the affixing of the Seal and if given after may be in general form confirming a number of affixing of the Seal. The Seal shall be affixed in the presence of a Director or a Secretary (or an assistant Secretary) or in the presence of any one or more Persons as the Directors may appoint for the purpose and every Person as aforesaid shall sign every instrument to which the Seal is so affixed in their presence.
108. The Company may maintain a facsimile of the Seal in such countries or places as the Directors may appoint and such facsimile Seal shall not be affixed to any instrument except by the authority of a resolution of the Directors provided always that such authority may be given prior to or after the affixing of such facsimile Seal and if given after may be in general form confirming a number of affixing of such facsimile Seal. The facsimile Seal shall be affixed in the presence of such Person or Persons as the Directors shall for this purpose appoint and such Person or Persons as aforesaid shall sign every instrument to which the facsimile Seal is so affixed in their presence and such affixing of the facsimile Seal and signing as aforesaid shall have the same meaning and effect as if the Seal had been affixed in the presence of and the instrument signed by a Director or a Secretary (or an assistant Secretary) or in the presence of any one or more Persons as the Directors may appoint for the purpose.
109. Notwithstanding the foregoing, a Secretary or any assistant Secretary shall have the authority to affix the Seal, or the facsimile Seal, to any instrument for the purposes of attesting authenticity of the matter contained therein but which does not create any obligation binding on the Company.

#### **DISQUALIFICATION OF DIRECTORS**

110. The office of Director shall be vacated, if the Director:
- (a) becomes bankrupt or makes any arrangement or composition with his creditors;
  - (b) dies or is found to be or becomes of unsound mind;
  - (c) resigns his office by notice in writing to the Company;
  - (d) is removed from office by notice addressed to them at their last known address and signed by all of their co-Directors (not being less than two in number); or
  - (e) is removed from office pursuant to any other provision of these Articles.

**PROCEEDINGS OF DIRECTORS**

111. The Directors may meet together (either within or outside of the Cayman Islands) for the despatch of business, adjourn, and otherwise regulate their meetings and proceedings as they think fit. Questions arising at any meeting shall be decided by a majority of votes. At any meeting of the Directors, each Director present in person or represented by his proxy or alternate shall be entitled to one vote. In case of an equality of votes the Chairperson shall have a second or casting vote. A Director may, and a Secretary or assistant Secretary on the requisition of a Director shall, at any time by not less than 24 hours' notice in writing to all of the Directors, summon a meeting of the Directors, provided that a meeting of the Directors may be convened on shorter notice with the agreement of all of the Directors.
112. A Director may participate in any meeting of the Directors, or of any committee appointed by the Directors of which such Director is a member, by means of telephone or similar communication equipment by way of which all Persons participating in such meeting can communicate with each other and such participation shall be deemed to constitute presence in person at the meeting.
113. The quorum necessary for the transaction of the business of the Board may be fixed by the Directors, and unless so fixed, the quorum shall be a majority of Directors then in office. A Director represented by proxy or by an alternate Director at any meeting shall be deemed to be present for the purposes of determining whether or not a quorum is present.
114. A Director who is in any way, whether directly or indirectly, interested in a contract or transaction or proposed contract or transaction with the Company shall declare the nature of his interest at a meeting of the Directors. A general notice given to the Directors by any Director to the effect that he is a member of any specified company or firm and is to be regarded as interested in any contract or transaction which may thereafter be made with that company or firm shall be deemed a sufficient declaration of interest in regard to any contract so made or transaction so consummated. Subject to the Designated Stock Exchange Rules and disqualification by the chairperson of the relevant Board meeting, a Director may vote in respect of any contract or transaction or proposed contract or transaction notwithstanding that he may be interested therein and if he does so his vote shall be counted and he may be counted in the quorum at any meeting of the Directors at which any such contract or transaction or proposed contract or transaction shall come before the meeting for consideration.
115. A Director may hold any other office or place of profit under the Company (other than the office of auditor) in conjunction with his office of Director for such period and on such terms (as to remuneration and otherwise) as the Directors may determine and no Director or intending Director shall be disqualified by his office from contracting with the Company either with regard to his tenure of any such other office or place of profit or as vendor, purchaser or otherwise, nor shall any such contract or arrangement entered into by or on behalf of the Company in which any Director is in any way interested be liable to be avoided, nor shall any Director so contracting or being so interested be liable to account to the Company for any profit realised by any such contract or arrangement by reason of such Director holding that office or of the fiduciary relation thereby established. A Director, notwithstanding his interest, may be counted in the quorum present at any meeting of the Directors whereat he or any other Director is appointed to hold any such office or place of profit under the Company or whereat the terms of any such appointment are arranged and he may vote on any such appointment or arrangement.
116. Any Director may act by himself or through his firm in a professional capacity for the Company, and he or his firm shall be entitled to remuneration for professional services as if he were not a Director; provided that nothing herein contained shall authorise a Director or his firm to act as auditor to the Company.
117. The Directors shall cause minutes to be made for the purpose of recording:
- (a) all appointments of officers made by the Directors;
  - (b) the names of the Directors present at each meeting of the Directors and of any committee of the Directors; and
  - (c) all resolutions and proceedings at all meetings of the Company, and of the Directors and of committees of Directors.

118. When the chairperson of a meeting of the Directors signs the minutes of such meeting the same shall be deemed to have been duly held notwithstanding that all the Directors have not actually come together or that there may have been a technical defect in the proceedings.
119. A resolution in writing signed by all the Directors or all the members of a committee of Directors entitled to receive notice of a meeting of Directors or committee of Directors, as the case may be (an alternate Director, subject as provided otherwise in the terms of appointment of the alternate Director, being entitled to sign such a resolution on behalf of his appointer), shall be as valid and effectual as if it had been passed at a duly called and constituted meeting of Directors or committee of Directors, as the case may be. When signed a resolution may consist of several documents each signed by one or more of the Directors or his duly appointed alternate.
120. The continuing Directors may act notwithstanding any vacancy in their body but if and for so long as their number is reduced below the number fixed by or pursuant to these Articles as the necessary quorum of Directors, the continuing Directors may act for the purpose of increasing the number, or of summoning a general meeting of the Company, but for no other purpose.
121. Subject to any regulations imposed on it by the Directors, a committee appointed by the Directors may elect a chairperson of its meetings. If no such chairperson is elected, or if at any meeting the chairperson is not present within fifteen minutes after the time appointed for holding the meeting, the committee members present may choose one of their number to be chairperson of the meeting.
122. A committee appointed by the Directors may meet and adjourn as it thinks proper. Subject to any regulations imposed on it by the Directors, questions arising at any meeting shall be determined by a majority of votes of the committee members present and in case of an equality of votes the chairperson shall have a second or casting vote.
123. All acts done by any meeting of the Directors or of a committee of Directors, or by any Person acting as a Director, shall notwithstanding that it be afterwards discovered that there was some defect in the appointment of any such Director or Person acting as aforesaid, or that they or any of them were disqualified, be as valid as if every such Person had been duly appointed and was qualified to be a Director.

#### **PRESUMPTION OF ASSENT**

124. A Director who is present at a meeting of the Board of Directors at which an action on any Company matter is taken shall be presumed to have assented to the action taken unless his dissent shall be entered in the minutes of the meeting or unless he shall file his written dissent from such action with the person acting as the chairperson or secretary of the meeting before the adjournment thereof or shall forward such dissent by registered post to such person immediately after the adjournment of the meeting. Such right to dissent shall not apply to a Director who voted in favour of such action.

#### **DIVIDENDS**

125. Subject to any rights and restrictions for the time being attached to any Shares, the Directors may from time to time declare dividends (including interim dividends) and other distributions on Shares in issue and authorise payment of the same out of the funds of the Company lawfully available therefor.
126. Subject to any rights and restrictions for the time being attached to any Shares, the Company by Ordinary Resolution may declare dividends, but no dividend shall exceed the amount recommended by the Directors.
127. The Directors may, before recommending or declaring any dividend, set aside out of the funds legally available for distribution such sums as they think proper as a reserve or reserves which shall, in the absolute discretion of the Directors, be applicable for meeting contingencies or for equalising dividends or for any other purpose to which those funds may be properly applied, and pending such application may in the absolute discretion of the Directors, either be employed in the business of the Company or be invested in such investments (other than Shares of the Company) as the Directors may from time to time think fit.

128. Any dividend payable in cash to the holder of Shares may be paid in any manner determined by the Directors. If paid by cheque it will be sent by mail addressed to the holder at his address in the Register, or addressed to such person and at such addresses as the holder may direct. Every such cheque or warrant shall, unless the holder or joint holders otherwise direct, be made payable to the order of the holder or, in the case of joint holders, to the order of the holder whose name stands first on the Register in respect of such Shares, and shall be sent at his or their risk and payment of the cheque or warrant by the bank on which it is drawn shall constitute a good discharge to the Company.
129. The Directors may determine that a dividend shall be paid wholly or partly by the distribution of specific assets (which may consist of the shares or securities of any other company) and may settle all questions concerning such distribution. Without limiting the generality of the foregoing, the Directors may fix the value of such specific assets, may determine that cash payment shall be made to some Shareholders in lieu of specific assets and may vest any such specific assets in trustees on such terms as the Directors think fit.
130. Subject to any rights and restrictions for the time being attached to any Shares, all dividends shall be declared and paid according to the amounts paid up on the Shares, but if and for so long as nothing is paid up on any of the Shares dividends may be declared and paid according to the par value of the Shares. No amount paid on a Share in advance of calls shall, while carrying interest, be treated for the purposes of this Article as paid on the Share.
131. If several Persons are registered as joint holders of any Share, any of them may give effective receipts for any dividend or other moneys payable on or in respect of the Share.
132. No dividend shall bear interest against the Company.
133. Any dividend unclaimed after a period of six calendar years from the date of declaration of such dividend may be forfeited by the Board of Directors and, if so forfeited, shall revert to the Company.

#### **ACCOUNTS, AUDIT AND ANNUAL RETURN AND DECLARATION**

134. The books of account relating to the Company's affairs shall be kept in such manner as may be determined from time to time by the Directors.
135. The books of account shall be kept at the Registered Office, or at such other place or places as the Directors think fit, and shall always be open to the inspection of the Directors.
136. The Directors may from time to time determine whether and to what extent and at what times and places and under what conditions or regulations the accounts and books of the Company or any of them shall be open to the inspection of Shareholders not being Directors, and no Shareholder (not being a Director) shall have any right to inspect any account or book or document of the Company except as conferred by law or authorised by the Directors or by Ordinary Resolution.
137. The accounts relating to the Company's affairs shall be audited in such manner and with such financial year end as may be determined from time to time by the Directors or failing any determination as aforesaid shall not be audited.
138. The Directors may appoint an auditor of the Company who shall hold office until removed from office by a resolution of the Directors and may fix his or their remuneration.
139. Every auditor of the Company shall have a right of access at all times to the books and accounts and vouchers of the Company and shall be entitled to require from the Directors and officers of the Company such information and explanation as may be necessary for the performance of the duties of the auditors.
140. The auditors shall, if so required by the Directors, make a report on the accounts of the Company during their tenure of office at the next annual general meeting following their appointment, and at any time during their term of office, upon request of the Directors or any general meeting of the Members.
141. The Directors in each calendar year shall prepare, or cause to be prepared, an annual return and declaration setting forth the particulars required by the Companies Act and deliver a copy thereof to the Registrar of Companies in the Cayman Islands.

### **CAPITALISATION OF RESERVES**

142. Subject to the Companies Act, the Directors may:

- (a) resolve to capitalise an amount standing to the credit of reserves (including a Share Premium Account, capital redemption reserve and profit and loss account), which is available for distribution;
- (b) appropriate the sum resolved to be capitalised to the Shareholders in proportion to the nominal amount of Shares (whether or not fully paid) held by them respectively and apply that sum on their behalf in or towards:
  - (i) paying up the amounts (if any) for the time being unpaid on Shares held by them respectively, or
  - (ii) paying up in full unissued Shares or debentures of a nominal amount equal to that sum,

and allot the Shares or debentures, credited as fully paid, to the Shareholders (or as they may direct) in those proportions, or partly in one way and partly in the other, but the Share Premium Account, the capital redemption reserve and profits which are not available for distribution may, for the purposes of this Article, only be applied in paying up unissued Shares to be allotted to Shareholders credited as fully paid;

- (c) make any arrangements they think fit to resolve a difficulty arising in the distribution of a capitalised reserve and in particular, without limitation, where Shares or debentures become distributable in fractions the Directors may deal with the fractions as they think fit;
- (d) authorise a Person to enter (on behalf of all the Shareholders concerned) into an agreement with the Company providing for either:
  - (i) the allotment to the Shareholders respectively, credited as fully paid, of Shares or debentures to which they may be entitled on the capitalisation, or
  - (ii) the payment by the Company on behalf of the Shareholders (by the application of their respective proportions of the reserves resolved to be capitalised) of the amounts or part of the amounts remaining unpaid on their existing Shares,

and any such agreement made under this authority being effective and binding on all those Shareholders; and

- (e) generally do all acts and things required to give effect to the resolution.

143. Notwithstanding any provisions in these Articles, the Directors may resolve to capitalise an amount standing to the credit of reserves (including the share premium account, capital redemption reserve and profit and loss account) or otherwise available for distribution by applying such sum in paying up in full unissued Shares to be allotted and issued to:

- (a) employees (including Directors) or service providers of the Company or its subsidiaries or group companies upon exercise or vesting of any options or awards granted under any share incentive scheme or employee benefit scheme or other arrangement which relates to such persons that has been adopted or approved by the Directors or the Members; or
- (b) any trustee of any trust or administrator of any share incentive scheme or employee benefit scheme to whom shares are to be allotted and issued by the Company in connection with the operation of any share incentive scheme or employee benefit scheme or other arrangement which relates to such persons that has been adopted or approved by the Directors or Members.

### **SHARE PREMIUM ACCOUNT**

144. The Directors shall in accordance with the Companies Act establish a Share Premium Account and shall carry to the credit of such account from time to time a sum equal to the amount or value of the premium paid on the issue of any Share.

145. There shall be debited to any Share Premium Account on the redemption or purchase of a Share the difference between the nominal value of such Share and the redemption or purchase price provided always that at the discretion of the Directors such sum may be paid out of the profits of the Company or, if permitted by the Companies Act, out of capital.

#### NOTICES

146. Except as otherwise provided in these Articles, any notice or document may be served by the Company or by the Person entitled to give notice to any Shareholder either personally, or by posting it by airmail or a recognised courier service in a prepaid letter addressed to such Shareholder at his address as appearing in the Register, or by electronic mail to any electronic mail address such Shareholder may have specified in writing for the purpose of such service of notices, or by facsimile to any facsimile number such Shareholder may have specified in writing for the purpose of such service of notices, or by placing it on the Company's Website should the Directors deem it appropriate. In the case of joint holders of a Share, all notices shall be given to that one of the joint holders whose name stands first in the Register in respect of the joint holding, and notice so given shall be sufficient notice to all the joint holders.
147. Notices sent from one country to another shall be sent or forwarded by prepaid airmail or a recognised courier service.
148. Any Shareholder Present at any meeting of the Company shall for all purposes be deemed to have received due notice of such meeting and, where requisite, of the purposes for which such meeting was convened.
149. Any notice or other document, if served by:
- (a) post, shall be deemed to have been served five calendar days after the time when the letter containing the same is posted;
  - (b) facsimile, shall be deemed to have been served upon production by the transmitting facsimile machine of a report confirming transmission of the facsimile in full to the facsimile number of the recipient;
  - (c) recognised courier service, shall be deemed to have been served 48 hours after the time when the letter containing the same is delivered to the courier service; or
  - (d) electronic means, shall be deemed to have been served immediately (i) upon the time of the transmission to the electronic mail address supplied by the Shareholder to the Company or (ii) upon the time of its placement on the Company's Website.

In proving service by post or courier service it shall be sufficient to prove that the letter containing the notice or documents was properly addressed and duly posted or delivered to the courier service.

150. Any notice or document delivered or sent by post to or left at the registered address of any Shareholder in accordance with the terms of these Articles shall notwithstanding that such Shareholder be then dead or bankrupt, and whether or not the Company has notice of his death or bankruptcy, be deemed to have been duly served in respect of any Share registered in the name of such Shareholder as sole or joint holder, unless his name shall at the time of the service of the notice or document have been removed from the Register as the holder of the Share, and such service shall for all purposes be deemed a sufficient service of such notice or document on all Persons interested (whether jointly with or as claiming through or under him) in the Share.
151. Notice of every general meeting of the Company shall be given to:
- (a) all Shareholders holding Shares with the right to receive notice and who have supplied to the Company an address for the giving of notices to them; and
  - (b) every Person entitled to a Share in consequence of the death or bankruptcy of a Shareholder, who but for his death or bankruptcy would be entitled to receive notice of the meeting.

No other Person shall be entitled to receive notices of general meetings.

**INFORMATION**

152. Subject to the relevant laws, rules and regulations applicable to the Company, no Member shall be entitled to require discovery of any information in respect of any detail of the Company's trading or any information which is or may be in the nature of a trade secret or secret process which may relate to the conduct of the business of the Company and which in the opinion of the Board would not be in the interests of the Members of the Company to communicate to the public.
153. Subject to due compliance with the relevant laws, rules and regulations applicable to the Company, the Board shall be entitled to release or disclose any information in its possession, custody or control regarding the Company or its affairs to any of its Members including, without limitation, information contained in the Register and transfer books of the Company.

**INDEMNITY**

154. Every Director (including for the purposes of this Article any alternate Director appointed pursuant to the provisions of these Articles), Secretary, assistant Secretary, or other officer for the time being and from time to time of the Company (but not including the Company's auditors) and the personal representatives of the same (each an "Indemnified Person") shall be indemnified and secured harmless against all actions, proceedings, costs, charges, expenses, losses, damages or liabilities incurred or sustained by such Indemnified Person, other than by reason of such Indemnified Person's own dishonesty, wilful default or fraud, in or about the conduct of the Company's business or affairs (including as a result of any mistake of judgment) or in the execution or discharge of his duties, powers, authorities or discretions, including without prejudice to the generality of the foregoing, any costs, expenses, losses or liabilities incurred by such Indemnified Person in defending (whether successfully or otherwise) any civil proceedings concerning the Company or its affairs in any court whether in the Cayman Islands or elsewhere.
155. No Indemnified Person shall be liable:
- (a) for the acts, receipts, neglects, defaults or omissions of any other Director or officer or agent of the Company; or
  - (b) for any loss on account of defect of title to any property of the Company; or
  - (c) on account of the insufficiency of any security in or upon which any money of the Company shall be invested; or
  - (d) for any loss incurred through any bank, broker or other similar Person; or
  - (e) for any loss occasioned by any negligence, default, breach of duty, breach of trust, error of judgement or oversight on such Indemnified Person's part; or
  - (f) for any loss, damage or misfortune whatsoever which may happen in or arise from the execution or discharge of the duties, powers, authorities, or discretions of such Indemnified Person's office or in relation thereto;
- unless the same shall happen through such Indemnified Person's own dishonesty, willful default or fraud.

**FINANCIAL YEAR**

156. Unless the Directors otherwise prescribe, the financial year of the Company shall end on March 31<sup>st</sup> in each calendar year and shall begin on April 1st in each calendar year.

**NON-RECOGNITION OF TRUSTS**

157. No Person shall be recognised by the Company as holding any Share upon any trust and the Company shall not, unless required by law, be bound by or be compelled in any way to recognise (even when having notice thereof) any equitable, contingent, future or partial interest in any Share or (except only as

otherwise provided by these Articles or as the Companies Act requires) any other right in respect of any Share except an absolute right to the entirety thereof in each Shareholder registered in the Register.

#### **WINDING UP**

158. If the Company shall be wound up the liquidator may, with the sanction of a Special Resolution of the Company and any other sanction required by the Companies Act, divide amongst the Members in specie or in kind the whole or any part of the assets of the Company (whether they shall consist of property of the same kind or not) and may for that purpose value any assets and determine how the division shall be carried out as between the Members or different classes of Members. The liquidator may, with the like sanction, vest the whole or any part of such assets in trustees upon such trusts for the benefit of the Members as the liquidator, with the like sanction, shall think fit, but so that no Member shall be compelled to accept any asset upon which there is a liability.
159. If the Company shall be wound up, and the assets available for distribution amongst the Members shall be insufficient to repay the whole of the share capital, such assets shall be distributed so that, as nearly as may be, the losses shall be borne by the Members in proportion to the par value of the Shares held by them. If in a winding up the assets available for distribution amongst the Members shall be more than sufficient to repay the whole of the share capital at the commencement of the winding up, the surplus shall be distributed amongst the Members in proportion to the par value of the Shares held by them at the commencement of the winding up subject to a deduction from those Shares in respect of which there are monies due, of all monies payable to the Company for unpaid calls or otherwise. This Article is without prejudice to the rights of the holders of Shares issued upon special terms and conditions.

#### **AMENDMENT OF ARTICLES OF ASSOCIATION**

160. Subject to the Companies Act, the Company may at any time and from time to time by Special Resolution alter or amend these Articles in whole or in part.

#### **CLOSING OF REGISTER OR FIXING RECORD DATE**

161. For the purpose of determining those Shareholders that are entitled to receive notice of, attend or vote at any meeting of Shareholders or any adjournment thereof, or those Shareholders that are entitled to receive payment of any dividend, or in order to make a determination as to who is a Shareholder for any other purpose, the Directors may provide that the Register shall be closed for transfers for a stated period which shall not exceed in any case thirty calendar days in any calendar year.
162. In lieu of or apart from closing the Register, the Directors may fix in advance a date as the record date for any such determination of those Shareholders that are entitled to receive notice of, attend or vote at a meeting of the Shareholders and for the purpose of determining those Shareholders that are entitled to receive payment of any dividend the Directors may, at or within ninety calendar days prior to the date of declaration of such dividend, fix a subsequent date as the record date for such determination.
163. If the Register is not so closed and no record date is fixed for the determination of those Shareholders entitled to receive notice of, attend or vote at a meeting of Shareholders or those Shareholders that are entitled to receive payment of a dividend, the date on which notice of the meeting is posted or the date on which the resolution of the Directors declaring such dividend is adopted, as the case may be, shall be the record date for such determination of Shareholders. When a determination of those Shareholders that are entitled to receive notice of, attend or vote at a meeting of Shareholders has been made as provided in this Article, such determination shall apply to any adjournment thereof.

#### **REGISTRATION BY WAY OF CONTINUATION**

164. The Company may by Special Resolution resolve to be registered by way of continuation in a jurisdiction outside the Cayman Islands or such other jurisdiction in which it is for the time being incorporated, registered or existing. In furtherance of a resolution adopted pursuant to this Article, the Directors may cause an application to be made to the Registrar of Companies to deregister the Company in the Cayman



Islands or such other jurisdiction in which it is for the time being incorporated, registered or existing and may cause all such further steps as they consider appropriate to be taken to effect the transfer by way of continuation of the Company.

**DISCLOSURE**

165. The Directors, or any service providers (including the officers, the Secretary and the registered office provider of the Company) specifically authorised by the Directors, shall be entitled to disclose to any regulatory or judicial authority any information regarding the affairs of the Company including without limitation information contained in the Register and books of the Company.

## PLAN OF MERGER

**THIS PLAN OF MERGER** is made on [•] 2022

### BETWEEN

- (1) **Summit Healthcare Acquisition Corp.**, an exempted company incorporated under the laws of the Cayman Islands having its registered office at the offices of Maples Corporate Services Limited, PO Box 309, Ugland House, Grand Cayman, KY1-1104, Cayman Islands (the “Company” or “SPAC” or, upon and with effect from the Effective Time (as defined below), the “Surviving Company”); and
- (2) **Oceanview Bioscience Acquisition Co., Ltd.**, an exempted company incorporated under the laws of the Cayman Islands having its registered office at the offices of Maples Corporate Services Limited, PO Box 309, Ugland House, Grand Cayman, KY1-1104, Cayman Islands (the “Merging Company” and together with the Company, the “Constituent Companies”).

### WHEREAS

- (A) The respective boards of directors of the Company and the Merging Company have approved the merger of the Constituent Companies pursuant to section 233(3) of the Companies Act (As Revised) of the Cayman Islands (the “Companies Act”), pursuant to which the Merging Company will merge with and into the Company and cease to exist, with the Surviving Company continuing as the surviving company in the merger (the “Merger”), upon the terms and subject to the conditions of the Business Combination Agreement dated [•] 2022 by and among YishengBio Co., Ltd, an exempted company incorporated under the laws of the Cayman Islands, the Company and the Merging Company (the “Merger Agreement”) and this Plan of Merger and pursuant to provisions of Part XVI of the Companies Act.
- (B) The shareholders of each of the Company and the Merging Company have approved and authorised this Plan of Merger on the terms and subject to the conditions set forth herein and otherwise pursuant to section 233(6) of the Companies Act.
- (C) Each of the Company and the Merging Company wishes to enter into this Plan of Merger pursuant to the provisions of Part XVI of the Companies Act.

### IT IS AGREED

#### 1. DEFINITIONS AND INTERPRETATION

- 1.1 Terms not otherwise defined in this Plan of Merger shall have the meanings given to them in the Merger Agreement, a copy of which is annexed at Annexure 1 hereto.

#### 2. PLAN OF MERGER

##### 2.1 Company Details:

- (a) The constituent companies (as defined in the Companies Act) to the Merger are the Company and the Merging Company.
- (b) The surviving company (as defined in the Companies Act) is the Surviving Company, which shall continue to be named Summit Healthcare Acquisition Corp..
- (c) The registered office of the Company at the date of this Plan of Merger is at the offices of Maples Corporate Services Limited, PO Box 309, Ugland House, Grand Cayman, KY1-1104, Cayman Islands. The registered office of the Merging Company at the date of this Plan of Merger is at the offices of Maples Corporate Services Limited, PO Box 309, Ugland House, Grand Cayman, KY1-1104, Cayman Islands. Following the effectiveness of the Merger, the registered office of the Surviving Company will be at the offices of Maples Corporate Services Limited, PO Box 309, Ugland House, Grand Cayman, KY1-1104, Cayman Islands.

- (d) Immediately prior to the Effective Time (as defined below), the authorised share capital of the Company is US\$55,500 divided into (i) 500,000,000 class A ordinary shares of a par value of US\$0.0001 each (“**SPAC Class A Ordinary Shares**”), (ii) 50,000,000 class B ordinary shares of a par value of US\$0.0001 each (“**SPAC Class B Ordinary Shares**”), and (iii) 5,000,000 preference shares of a par value of US\$0.0001 each (“**SPAC Preference Shares**”), of which 23,000,000 SPAC Class A Ordinary Shares, 4,303,475 SPAC Class B Ordinary Shares and no SPAC Preference Shares have been issued.
- (e) Immediately prior to the Effective Time (as defined below), the authorised share capital of the Merging Company is US\$45,500 divided into 455,000,000 ordinary shares of a par value of US\$0.0001 each, of which one (1) share has been issued.
- (f) On the Effective Time (as defined below), the authorised share capital of the Surviving Company shall be US\$45,500 divided into 455,000,000 shares of a par value of US\$0.0001 each.

## 2.2 Effective Time

In accordance with Section 233(13) of the Companies Act, the Merger shall be effective on the date that this Plan of Merger is registered by the Registrar of Companies in the Cayman Islands (the “Effective Time”).

## 2.3 Terms and Conditions; Share Rights

- (a) At the Effective Time, and in accordance with the terms and conditions of the Merger Agreement:
  - (i) Each share of par value US\$0.0001 of the Merging Company issued and outstanding immediately prior to the Effective Time shall automatically be converted into and become one validly issued, fully paid and non-assessable ordinary share of par value US\$[0.0001] of the Surviving Company; such conversion shall be effected by means of the cancellation of such share of the Merging Company, in exchange for the right to receive one such ordinary share of the Surviving Company.
  - (ii) Each SPAC Class A Ordinary Share (which, for the avoidance of doubt, includes (x) the SPAC Class A Ordinary Shares held by the public shareholders of SPAC as a result of the Unit Separation and (y) the SPAC Class A Ordinary Shares issued pursuant to the Forward Purchase Subscriptions) issued and outstanding immediately prior to the Effective Time (other than any SPAC Shares referred to in paragraph 2.3(a)(v) below and paragraph 2.3(a)(vi) below, Redeeming SPAC Shares and Dissenting SPAC Shares) shall automatically be cancelled and cease to exist in exchange for the right to receive, upon delivery of the applicable Letter of Transmittal (if any) in accordance with Section 2.4 of the Merger Agreement, such fraction of a newly issued Company Ordinary Share that is equal to the SPAC Class A Exchange Ratio, without interest, subject to rounding pursuant to Section 2.4(e) of the Merger Agreement;
  - (iii) An aggregate of 1,446,525 SPAC Class B Ordinary Shares held by the Sponsor will be surrendered for nil consideration;
  - (iv) After such surrender pursuant to paragraph 2.3(a)(iii) above, each of the remaining SPAC Class B Ordinary Shares issued and outstanding immediately prior to the Effective Time and held by the SPAC Insiders (and the SPAC Class A Ordinary Shares into which such SPAC Class B Ordinary Shares are convertible or converted), shall automatically be cancelled and cease to exist in exchange for the right to receive, upon delivery of the applicable Letter of Transmittal (if any) in accordance with Section 2.4 of the Merger Agreement, one newly issued Company Ordinary Share;
  - (v) Each SPAC Class B Ordinary Share held by a Forward Purchase Investor and its permitted transferees (and the SPAC Class A Ordinary Shares into which such SPAC

Class B Ordinary Shares are convertible or converted) issued and outstanding immediately prior to the Effective Time shall automatically be cancelled and cease to exist in exchange for the right to receive, upon delivery of the applicable Letter of Transmittal (if any) in accordance with Section 2.4 of the Merger Agreement, (a) such fraction of a newly issued Company Ordinary Share that is equal to the SPAC Class A Exchange Ratio, without interest, subject to rounding pursuant to Section 2.4(e) of the Merger Agreement, if and only if such Forward Purchase Investor has delivered its portion of the Forward Purchase Investment Amount as required under the applicable Forward Purchase Agreement and, failing that, (b) one newly issued Company Ordinary Share;

- (vi) Notwithstanding paragraphs 2.3(a)(ii) to (v) above or any other provision of the Merger Agreement to the contrary, if there are any SPAC Shares that are owned by SPAC as treasury shares or any SPAC Shares owned by any direct or indirect Subsidiary of SPAC immediately prior to the Effective Time, such SPAC Shares shall be cancelled and shall cease to exist without any conversion thereof or payment or other consideration therefor;
  - (vii) Each Redeeming SPAC Share issued and outstanding immediately prior to the Effective Time shall be cancelled and cease to exist and shall thereafter represent only the right to be paid a pro rata share of the SPAC Shareholder Redemption Amount in accordance with the SPAC's Charter; and
  - (viii) Each Dissenting SPAC Share issued and outstanding immediately prior to the Effective Time held by a Dissenting SPAC Shareholder shall be cancelled and cease to exist in accordance with Section 2.6(a) of the Merger Agreement, and shall thereafter represent only the right to be paid the fair value of such Dissenting SPAC Share and such other rights pursuant to Section 238 of the Companies Act.
- (b) At the Effective Time, the rights and restrictions attaching to the ordinary shares of the Surviving Company shall be as set out in the second amended and restated memorandum and articles of association of the Surviving Company in the form annexed at Annexure 2 hereto.
  - (c) At the Effective Time, the amended and restated memorandum and articles of association of the Company shall be amended and restated by their deletion in their entirety and the substitution in their place of the second amended and restated memorandum and articles of association of the Surviving Company in the form annexed at Annexure 2 hereto.
  - (d) At the Effective Time, the rights, property of every description including choses in action, and the business, undertaking, goodwill, benefits, immunities and privileges of each of the Constituent Companies shall immediately vest in the Surviving Company which shall be liable for and subject, in the same manner as the Constituent Companies, to all mortgages, charges, or security interests and all contracts, obligations, claims, debts and liabilities of each of the Constituent Companies.

#### **2.4 Directors' Interests in the Merger**

- (a) The name and address of the sole director of the Surviving Company after the Merger becomes effective is:
  - (i) Yi Zhang of Room 4, Unit 7, Bldg 1, Longtingxi Street Residence Zone, Kaifeng City, Henan Province, China
- (b) There are no amounts or benefits paid or payable to any director of either of the Constituent Companies or the Surviving Company consequent upon the Merger.

#### **2.5 Secured Creditors**

- (a) The Company has no secured creditors and has granted no fixed or floating security interests that are outstanding as at the date of this Plan of Merger.
- (b) The Merging Company has no secured creditors and has granted no fixed or floating security interests that are outstanding as at the date of this Plan of Merger.

**3. VARIATION**

3.1 At any time prior to the Effective Time, this Plan of Merger may be amended by the boards of directors of both the Company and the Merging Company to:

- (i) change the Effective Time provided that such changed date shall not be a date later than the ninetieth day after the date of registration of this Plan of Merger with the Registrar of Companies in the Cayman Islands; and
- (ii) effect any other changes to this Plan of Merger as the Merger Agreement or this Plan of Merger may expressly authorise the boards of directors of both the Company and the Merging Company to effect in their discretion.

**4. TERMINATION**

4.1 At any time prior to the Effective Time, this Plan of Merger may be terminated by the boards of directors of both the Company and the Merging Company in accordance with the terms of the Merger Agreement.

**5. COUNTERPARTS**

5.1 This Plan of Merger may be executed in any number of counterparts, all of which taken together shall constitute one and the same instrument. Any party may enter into this Plan of Merger by executing any such counterpart.

**6. GOVERNING LAW**

6.1 This Plan of Merger and the rights and obligations of the parties shall be governed by and construed in accordance with the laws of the Cayman Islands.

6.2 Each of the parties agrees that the courts of the Cayman Islands shall have jurisdiction to hear and determine any action or proceeding arising out of or in connection with this Plan of Merger only, and any non-contractual obligations arising out of or in connection with it, and for that purpose each party irrevocably submits to the jurisdiction of the courts of the Cayman Islands.

IN WITNESS whereof this Plan of Merger has been entered into by the parties on the day and year first above written.

SIGNED for and on behalf of )  
**Summit Healthcare Acquisition Corp.:** ) Duly Authorised Signatory  
 ) Name: \_\_\_\_\_  
 )  
 ) Title: \_\_\_\_\_  
 )  
 )

SIGNED for and on behalf of )  
**Oceanview Bioscience Acquisition Co., Ltd.:** ) Duly Authorised Signatory  
 ) Name: \_\_\_\_\_  
 )  
 ) Title: \_\_\_\_\_  
 )  
 )

---

**ANNEXURE 1**  
**MERGER AGREEMENT**

---

**ANNEXURE 2**

**AMENDED AND RESTATED MEMORANDUM AND ARTICLES OF ASSOCIATION OF SURVIVING  
COMPANY**

---



**FAIRNESS OPINION  
RELATED TO THE BUSINESS COMBINATION  
WITH YISHENGBIO Co., LTD. BY  
SUMMIT HEALTHCARE ACQUISITION CORP.**

**VALUATION DATE: MARCH 31, 2022  
REPORT DATE: SEPTEMBER 27, 2022**

Prepared for:

Board of Directors  
Summit Healthcare Acquisition Corp.





**September 27, 2022**

Board of Directors  
c/o Bo Tan, CEO & Co-Chief Investment Officer &  
Ken Poon, President & Co-Chief Investment Officer  
Summit Healthcare Acquisition Corp.  
1 Lyndhurst Tower, 1 Lyndhurst Terrace  
Central, Hong Kong

Dear Members of the Board of Directors:

ValueScope, Inc. was engaged to serve as an independent financial advisor to the Board of Directors (the “Board”) of Summit Healthcare Acquisition Corp. (“Summit” or the “Client”) to provide an opinion as of the date hereof as to the fairness, from a financial point of view, to shareholders of Summit of a potential business combination (the “Subject Transaction”) pursuant to a business combination agreement (the “Business Combination Agreement”) to be entered into by Summit, YishengBio Co., Ltd. (to be renamed as YS Biopharma Co., Ltd and referred to herein as “YS Biopharma”), and other parties thereto. Our analysis is based on the financial, business, and operating information available as of March 31, 2022 (the “Valuation Date”).

Our opinion is based on a review of publicly available business and financial information relating to Summit and YS Biopharma. We have also reviewed internal financial and operating information related to Summit and YS Biopharma, including financial forecasts prepared by YS Biopharma’s management (the “Management”). In addition, we have interviewed members of Management. Based on our valuation experience, understanding of the market, and review of YS Biopharma’s industry, we made certain adjustments to Management forecasts we deemed appropriate. Additionally, we conducted a sensitivity analysis on certain key valuation inputs and assumptions to determine their impact on the conclusion. Based on the procedures and methodologies discussed below:

**SUBJECT TRANSACTION IS FAIR TO THE SHAREHOLDERS OF SUMMIT HEALTHCARE  
ACQUISITION CORP. FROM A FINANCIAL POINT OF VIEW**

This opinion is based on financial analyses prepared in accordance with generally accepted valuation standards. These procedures included substantive valuation tests that we considered necessary and appropriate under the circumstances.

Our analyses relied upon, but were not necessarily limited to, the following procedures:

- A review of the documents related to the Subject Transaction and the terms thereof, including the Letter of Intent, dated as of July 1, 2022 and drafts of the definitive transaction documents.
- A review of the global vaccine industry and market expectations.
- A review of YS Biopharma’s financial statements as of March 31, 2022.
- A review of Management’s financial and product projections.
- Discussed the past and current operations, financial conditions, and the prospects of YS Biopharma with Summit and its advisors.
- A review of information relating to YS Biopharma’s industry and comparable companies, including financial and share price information, as of the Valuation Date.

950 E. State Highway 114 • Suite 120 • Southlake • Texas • 76092 • Tel: 817.481.4900 • Fax: 817.481.4905

[www.valuescopeinc.com](http://www.valuescopeinc.com)

---

- A review of data of comparable companies and industry transactions existing as of the Valuation Date.
- Performed such other analyses, reviewed such other information, and considered such other factors as we have deemed appropriate.

We have not independently verified any of the foregoing information and have relied upon its completeness and accuracy in all material aspects. For purposes of rendering this opinion, we have, with your consent, relied upon and assumed the accuracy and completeness of all of the financial, legal, regulatory, tax, accounting and other information provided to, discussed with or reviewed by us, without assuming any responsibility for independent verification thereof. In that regard, we have assumed with your consent that the forecasts and the projections have been reasonably prepared on a basis reflecting the best currently available estimates and judgments of Management. We have not made an independent evaluation or appraisal of the assets and liabilities.

Our opinion does not address the underlying business decision of Summit to engage in the Subject Transaction, or the relative merits of the Subject Transaction compared to any strategic alternatives that may be available to Summit; nor does it address any legal, regulatory, tax or accounting matters. This opinion addresses only the fairness of the Subject Transaction from a financial point of view to the shareholders of Summit.

We are not acting as the financial advisor to Summit or its shareholders in connection with the Subject Transaction. It is understood that this letter is for the use by the Board and the shareholders of Summit. This letter is not to be used with any other document in connection with the Subject Transaction, without the express written consent of ValueScope, Inc. We understand and agree that our analysis and conclusion in this letter may be shared with current and potential shareholders and advisors of Summit.

We are of the opinion that the total consideration to be paid by Summit in the Subject Transaction is **FAIR** to the shareholders of Summit from a financial point of view.

We are independent of and have no current or prospective economic interests in Summit or YS Biopharma. Our fee for the development of this fairness opinion was in no way influenced by or contingent upon our conclusion expressed in the Fairness Opinion. Other than this engagement, during the two years preceding the date of this Fairness Opinion, ValueScope has not had any material relationship with any party of the Subject Transaction, for which compensation has been received, or is intended to be received, nor is any such material relationship or related compensation mutually understood to be contemplated.

Respectfully submitted,

/s/ ValueScope, Inc.

ValueScope, Inc.

/s/ Martin Hanan

---

Martin Hanan, CFA  
President

### **Assumptions and Limiting Conditions**

This Fairness Opinion prepared by ValueScope, Inc. (“ValueScope”) is subject to and governed by the following Assumptions and Limiting Conditions and other terms, assumptions and conditions contained in the engagement letter.

#### **Limitation on Distribution and Use**

The Fairness Opinion, the conclusion of fairness, and the prospective financial analyses included therein are intended solely for the information of the person or persons to whom they are addressed and solely for the purposes stated, they should not be relied upon for any other purpose, and no party other than the Board may rely on them for any purpose whatsoever. Neither the Fairness Opinion, nor its contents, nor any reference to the appraiser or ValueScope, may be referred to or quoted in any registration statement, prospectus, offering memorandum, sales brochure, other appraisal, loan or other agreement or document given to third parties without our prior written consent. We understand the Fairness Opinion may be disclosed in proxy/registration statements related to the Subject Transaction and agree to such disclosure and our involvement therein. In addition, except as set forth in the Fairness Opinion, our analysis and Fairness Opinion are not intended for general circulation or publication, nor are they to be reproduced or distributed to third parties without our prior written consent; provided, however, that if ValueScope fails to inform the Company whether ValueScope will provide such consent within five (5) business days after receiving the Company’s request thereof, then ValueScope’s consent shall be deemed conclusively to have been provided without any further action by the Board or ValueScope.

No change of any item in this Fairness Opinion shall be made by anyone other than ValueScope, and we shall have no responsibility for any such unauthorized change. The Fairness Opinion may not be used in conjunction with any other appraisal or study. The conclusion(s) stated in this appraisal is based on the program of utilization described in the Fairness Opinion and may not be separated into parts. The Fairness Opinion was prepared solely for the purpose, function and party so identified in the Fairness Opinion. The Fairness Opinion may not be reproduced, in whole or in part, and the conclusions may not be utilized by a third party for any purpose, without the express written consent of ValueScope.

As required by new U.S. Treasury rules, we inform you that, unless expressly stated otherwise, any U.S. federal tax advice contained in this Fairness Opinion, including attachments, is not intended or written to be used, and cannot be used, by any person for the purpose of avoiding any penalties that may be imposed by the Internal Revenue Service.

#### **Purpose of Fairness Opinion**

This Fairness Opinion was prepared for the sole purpose of reviewing the Subject Transaction. Our conclusion of fairness does not extend to any managerial decisions which occurred pre- or post-Subject Transaction.

#### **Operational Assumptions**

Unless stated otherwise, our analysis (i) assumes that, as of the Valuation Date, YS Biopharma and its assets will continue to operate as configured as a going concern, (ii) is based on the past, present and future projected financial condition of YS Biopharma and its assets as of the valuation date, and (iii) assumes that YS Biopharma has no undisclosed real or contingent assets or liabilities, other than in the ordinary course of business, that would have a material effect on our analysis.

We did not make an onsite visit to the YS Biopharma’s facilities.

#### **Competent Management Assumed**

It should be specifically noted that the Fairness Opinion assumes YS Biopharma will be competently managed and maintained over the expected period of ownership. This Fairness Opinion does not entail an evaluation of management’s effectiveness, nor are we responsible for future marketing efforts and other management or ownership actions upon which actual results will depend.

**No Obligation to Provide Services after Completion**

Valuation assignments are accepted with the understanding that there is no obligation to furnish services after completion of this engagement. If the need for subsequent services related to a valuation assignment (e.g., including testimony, preparation for testimony, other activity compelled by legal process, updates, conferences, reprint or copy services, document production or interrogatory response preparation, whether by request of the Board or by subpoena or other legal process initiated by a party other than the Board) arises, special arrangements for such services acceptable to ValueScope must be made in advance. ValueScope reserves the right to make adjustments to the analysis, opinion and conclusion set forth in the Fairness Opinion as we deem reasonably necessary based upon consideration of additional or more reliable data that may become available.

In all matters that may be potentially challenged by a Court or other party, we do not take responsibility for the degree of reasonableness of contrary positions that others may choose to take, nor for the costs or fees that may be incurred in the defense of our recommendations against challenge(s). We will, however, retain our supporting work papers for your matter(s), and will be available to assist in defending our professional positions taken, at our then current rates, plus direct expenses at actual, and according to our then current Standard Professional Agreement.

**No Opinion is Rendered as to Legal Fee or Property Title**

No opinion is rendered as to legal fee or property title. No opinion is intended in matters that require legal, engineering or other professional advice that has been or will be obtained from professional sources.

**Liens and Encumbrances**

ValueScope will give no consideration to liens or encumbrances except as specifically stated. We will assume that all required licenses and permits are in full force and effect, and we make no independent on-site tests to identify the presence of any potential environmental risks. We assume no responsibility for the acceptability of the valuation approaches used in our Fairness Opinion as legal evidence in any particular court or jurisdiction.

**Information Provided by Others**

Information furnished by others is presumed to be reliable; no responsibility, whether legal or otherwise, is assumed for its accuracy and cannot be guaranteed as being certain. All financial data, operating histories and other data relating to income and expenses attributed to the business have been provided by Management or its representatives and have been accepted without further verification except as specifically stated in the Fairness Opinion.

**Prospective Financial Information**

Fairness opinions may contain prospective financial information, estimates or opinions that represent reasonable expectations at a particular point in time, but such information, estimates or opinions are not offered as forecasts, prospective financial statements or opinions, predictions or as assurances that a particular level of income or profit will be achieved, that events will occur or that a particular price will be offered or accepted. Actual results achieved during the period covered by our prospective financial analysis will vary from those described in our Fairness Opinion, and the variations may be material.

Any use of Management's projections or forecasts in our analysis will not constitute an examination, review or compilation of prospective financial statements in accordance with standards established by the American Institute of Certified Public Accountants (AICPA). We will not express an opinion or any other form of assurance on the reasonableness of the underlying assumptions or whether any of the prospective financial statements, if used, are presented in conformity with AICPA presentation guidelines.

**Regulatory and Environmental Considerations**

The Fairness Opinion assumes all required licenses, certificates of occupancy, consents, or legislative or administrative authority from any local, state or national government, or private entity or organization have been or can be obtained or reviewed for any use on which the opinion contained in the Fairness Opinion are based.

ValueScope is not an environmental consultant or auditor, and it takes no responsibility for any actual or potential environmental liabilities. Any person entitled to rely on this Fairness Opinion, wishing to know whether such liabilities exist, or the scope and their effect on the value of the property, is encouraged to obtain a professional environmental assessment. ValueScope does not conduct or provide environmental assessments and has not performed one for the subject property.

ValueScope has not determined independently whether YS Biopharma or Summit are subject to any present or future liability relating to environmental matters (including, but not limited to CERCLA/Superfund liability) or the scope of any such liabilities. ValueScope's valuation takes no such liabilities into account, except as they have been reported to ValueScope by the Company or by an environmental consultant working for the Company, and then only to the extent that the liability was reported to us in an actual or estimated dollar amount. Such matters, if any, are noted in the Fairness Opinion. To the extent such information has been reported to us, ValueScope has relied on it without verification and offers no warranty or representation as to its accuracy or completeness.

Unless otherwise stated, no effort has been made to determine the possible effect, if any, on the subject business due to future federal, state, or local legislation, including any environmental or ecological matters or interpretations thereof.

ValueScope has not made a specific compliance survey or analysis of the subject property to determine whether it is subject to, or in compliance with, the American Disabilities Act of 1990, and this valuation does not consider the effect, if any, of noncompliance.

ValueScope expresses no opinion for matters that require legal or other specialized expertise, investigation, or knowledge beyond that customarily employed by business appraisers.

## PART II

## INFORMATION NOT REQUIRED IN PROSPECTUS

**Item 20. Indemnification of Directors and Officers**

The laws of the Cayman Islands do not limit the extent to which a company's memorandum and articles of association may provide for indemnification of officers and directors, except to the extent any such provision may be held by the Cayman Islands courts to be contrary to public policy, such as to provide indemnification against willful default, willful neglect, civil fraud or the consequences of committing a crime. The Amended YS Biopharma Articles that YS Biopharma expects to adopt and to become effective immediately prior to the First Merger Effective Time provides for indemnification of our officers and directors against all actions, proceedings, costs, charges, expenses, losses, damages or liabilities incurred or sustained by such person, other than by reason of such person's own dishonesty, wilful default or fraud, in or about the conduct of YS Biopharma's business or affairs (including as a result of any mistake of judgment) or in the execution or discharge of his duties, powers, authorities or discretions, including without prejudice to the generality of the foregoing, any costs, expenses, losses or liabilities incurred by such person in defending (whether successfully or otherwise) any civil proceedings concerning YS Biopharma or its affairs in any court whether in the Cayman Islands or elsewhere.

Under the form of indemnification agreement filed as Exhibit 10.6 to this registration statement, we will agree to indemnify each such person and hold him harmless against expenses, judgments, fines and amounts payable under settlement agreements in connection with any threatened, pending or completed action, suit or proceeding to which he has been made a party or in which he became involved by reason of the fact that he is or was our director or officer. Except with respect to expenses to be reimbursed by us in the event that the indemnified person has been successful on the merits or otherwise in defense of the action, suit or proceeding, our obligations under the indemnification agreements are subject to certain customary restrictions and exceptions.

In addition, we maintain standard policies of insurance under which coverage is provided to our directors and officers against loss rising from claims made by reason of breach of duty or other wrongful act, and to us with respect to payments which may be made by us to such directors and officers pursuant to the above indemnification provision or otherwise as a matter of law.

Insofar as indemnification for liabilities arising under the Securities Act may be permitted to directors, officers or persons controlling us pursuant to the foregoing provisions, we have been informed that in the opinion of the SEC such indemnification is against public policy as expressed in the Securities Act and is theretofore unenforceable.

**Item 21. Exhibits and Financial Statement Schedules**

Exhibit Number	Description
2.1 <sup>^</sup>	<a href="#"><u>Business Combination Agreement, dated as of September 29, 2022, by and among Summit, YS Biopharma, Merger Sub I and Merger Sub II (attached to the proxy statement/prospectus which forms part of this registration statement as Annex A).</u></a>
2.2 <sup>^</sup>	<a href="#"><u>Plan of Merger (First Merger) (attached to the proxy statement/prospectus which forms part of this registration statement as Annex C).</u></a>
3.1 <sup>^</sup>	<a href="#"><u>Form of Amended and Restated Memorandum and Articles of Association of YS Biopharma (attached to the proxy statement/prospectus which forms part of this registration statement as Annex B).</u></a>
3.2* <sup>^</sup>	<a href="#"><u>Memorandum and Articles of Association of YS Biopharma in effect prior to Closing.</u></a>
3.3 <sup>^</sup>	<a href="#"><u>Amended and Restated Memorandum and Articles of Association of Summit (incorporated herein by reference to Exhibit 3.1 of the Summit's Current Report on Form 8-K filed with the SEC on June 14, 2021).</u></a>

Exhibit Number	Description
4.1 <sup>^</sup>	<a href="#"><u>Specimen Unit certificate of Summit (incorporated herein by reference to Exhibit 4.1 of Summit's Amendment No. 2 to Form S-1 filed with the SEC on June 3, 2021).</u></a>
4.2 <sup>^</sup>	<a href="#"><u>Specimen Class A ordinary share certificate of Summit (incorporated herein by reference to Exhibit 4.2 of Summit's Amendment No. 2 to Form S-1 filed with the SEC on June 3, 2021).</u></a>
4.3 <sup>^</sup>	<a href="#"><u>Specimen warrant certificate of Summit (incorporated herein by reference to Exhibit 4.3 of Summit's Amendment No. 2 to Form S-1 filed with the SEC on June 3, 2021).</u></a>
4.4 <sup>^</sup>	<a href="#"><u>Warrant Agreement, dated as of June 8, 2021, between Summit and Continental Stock Transfer &amp; Trust Company (incorporated herein by reference to Exhibit 4.1 of Summit's Current Report on Form 8-K filed with the SEC on June 14, 2021).</u></a>
4.5 <sup>^</sup>	<a href="#"><u>Specimen ordinary share certificate of YS Biopharma.</u></a>
4.6 <sup>^</sup>	<a href="#"><u>Specimen warrant certificate of YS Biopharma.</u></a>
4.7 <sup>^</sup>	<a href="#"><u>Warrant Assignment Agreement, dated as of September 29, 2022, by and among YS Biopharma, Summit and Continental Stock Transfer &amp; Trust Company (included as Exhibit 10.2 hereto).</u></a>
5.1 <sup>^</sup>	<a href="#"><u>Opinion of Maples and Calder (Hong Kong) LLP as to validity of ordinary shares of YS Biopharma to be issued.</u></a>
5.2 <sup>^</sup>	<a href="#"><u>Opinion of Wilson Sonsini Goodrich &amp; Rosati as to the validity of the warrants of YS Biopharma to be issued.</u></a>
10.1 <sup>^</sup>	<a href="#"><u>Shareholder Support Agreement and Deed, dated as of September 29, 2022, by and among Summit, YS Biopharma, certain shareholders of YS Biopharma, Sponsor, and other parties thereto (incorporated herein by reference to Exhibit 10.1 of Summit's Current Report on Form 8-K filed with the SEC on September 29, 2022).</u></a>
10.2 <sup>^</sup>	<a href="#"><u>Warrant Assignment Agreement, dated as of September 29, 2022, by and among Summit, YS Biopharma and Warrant Agent (incorporated herein by reference to Exhibit 10.2 of Summit's Current Report on Form 8-K filed with the SEC on September 29, 2022).</u></a>
10.3 <sup>^</sup>	<a href="#"><u>Forward Purchase Agreement, dated as of April 30, 2021, between the Registrant, Summit Healthcare Acquisition Sponsor LLC and Snow Lake Capital (HK) Limited (incorporated herein by reference to Exhibit 10.6 of Summit's Current Report on Form 8-K filed with the SEC on June 14, 2021).</u></a>
10.4 <sup>^</sup>	<a href="#"><u>Forward Purchase Agreement, dated as of April 30, 2021, between the Registrant, Summit Healthcare Acquisition Sponsor LLC and the Valliance Fund (incorporated herein by reference to Exhibit 10.7 of Summit's Current Report on Form 8-K filed with the SEC on June 14, 2021).</u></a>
10.5 <sup>^</sup>	<a href="#"><u>YS Biopharma 2022 Equity Incentive Plan.</u></a>
10.6 <sup>^</sup>	<a href="#"><u>Form of Indemnification Agreement between YS Biopharma and each executive officer of YS Biopharma.</u></a>
10.7 <sup>^</sup>	<a href="#"><u>Letter Agreement, dated June 8, 2021, among Summit, the Sponsor and Summit's officers and directors (incorporated herein by reference to Exhibit 10.4 of Summit's Current Report on Form 8-K filed with the SEC on June 14, 2021).</u></a>
10.8 <sup>^</sup>	<a href="#"><u>Investment Management Trust Agreement, dated June 8, 2021, between Summit and Continental Stock Transfer &amp; Trust Company (incorporated herein by reference to Exhibit 10.2 of Summit's Current Report on Form 8-K filed with the SEC on June 14, 2021).</u></a>
10.9 <sup>*^</sup>	<a href="#"><u>Facility Agreement, dated as of March 16, 2022, by and among YishengBio Co., Ltd, Yishengbio (Hong Kong) Holdings Limited, Yisheng US Biopharma Inc., Yisheng Biopharma (Singapore) Pte. Ltd., Liaoning Yisheng Biopharma Co. Ltd., Beijing Yisheng Biotechnology Co., Ltd., R-Bridge Investment Three Pte. Ltd. And R-BRIDGE Healthcare Fund, LP</u></a>
10.10 <sup>*^</sup>	<a href="#"><u>Royalty Deed, dated as of March 16, 2022, by and among Yishengbio (Hong Kong) Holdings Limited and R-Bridge Healthcare Fund, LP</u></a>
10.11 <sup>*^</sup>	<a href="#"><u>Deed of Undertaking, dated as of March 16, 2022, by and among Yishengbio (Hong Kong) Holdings Limited and R-Bridge Healthcare Fund, LP</u></a>



Exhibit Number	Description
10.12* <sup>^</sup>	<a href="#">English translation of Guarantee Agreement, dated as of March 16, 2022, by and among Liaoning Yisheng Biopharma Co. Ltd., Beijing Yisheng Biotechnology Co., Ltd. and R-Bridge Healthcare Fund, LP.</a>
10.13* <sup>^</sup>	<a href="#">Acting-In-Concert Agreement dated March 3, 2021 entered into by and among the Concert Parties</a>
21.1 <sup>^</sup>	<a href="#">List of subsidiaries of YS Biopharma.</a>
23.1	<a href="#">Consent of WithumSmith+Brown, PC.</a>
23.2	<a href="#">Consent of Wei, Wei &amp; Co., LLP.</a>
23.3 <sup>^</sup>	<a href="#">Consent of Frost &amp; Sullivan.</a>
23.4 <sup>^</sup>	<a href="#">Consent of Maples and Caleder (Hong Kong) LLP (included in Exhibit 5.1).</a>
23.5 <sup>^</sup>	<a href="#">Consent of Wilson Sonsini Goodrich &amp; Rosati (included in Exhibit 5.2).</a>
23.6 <sup>^</sup>	<a href="#">Consent of Jingtian &amp; Gongcheng (included in Exhibit 99.3).</a>
23.7 <sup>^</sup>	<a href="#">Consent of ValueScope.</a>
24.1 <sup>^</sup>	<a href="#">Power of Attorney (including on signature page).</a>
99.1 <sup>^</sup>	<a href="#">Form of Proxy Card.</a>
99.2 <sup>^</sup>	<a href="#">Code of Business Conduct and Ethics of YS Biopharma.</a>
99.3 <sup>^</sup>	<a href="#">Opinion of Jingtian &amp; Gongcheng regarding certain matters under PRC law.</a>
99.4 <sup>^</sup>	<a href="#">Consent of Mr. Bo Tan, a director appointee of YS Biopharma.</a>
99.5 <sup>^</sup>	<a href="#">Consent of Mr. Shaojing Tong, an independent director appointee of YS Biopharma.</a>
107 <sup>^</sup>	<a href="#">Filing Fee Table.</a>

<sup>^</sup> Previously filed

\* Portions of this exhibit has been omitted in accordance with Item 601(b)(10) (iv) of Regulation S-K.

## Item 22. Undertakings

The undersigned registrant hereby undertakes:

- (1) To file, during any period in which offers or sales are being made, a post-effective amendment to this registration statement:
  - i. To include any prospectus required by Section 10(a)(3) of the Securities Act of 1933;
  - ii. To reflect in the prospectus any facts or events arising after the effective date of the registration statement (or the most recent post-effective amendment thereof) which, individually or in the aggregate, represent a fundamental change in the information set forth in the registration statement. Notwithstanding the foregoing, any increase or decrease in volume of securities offered (if the total dollar value of securities offered would not exceed that which was registered) and any deviation from the low or high end of the estimated maximum offering range may be reflected in the form of prospectus filed with the Commission pursuant to Rule 424(b) if, in the aggregate, the changes in volume and price represent no more than 20 percent change in the maximum aggregate offering price set forth in the "Calculation of Registration Fee" table in the effective registration statement.
  - iii. To include any material information with respect to the plan of distribution not previously disclosed in the registration statement or any material change to such information in the registration statement.
- (2) That, for the purpose of determining any liability under the Securities Act of 1933, each such post-effective amendment shall be deemed to be a new registration statement relating to the securities offered therein, and the offering of such securities at that time shall be deemed to be the initial bona fide offering thereof.
- (3) To remove from registration by means of a post-effective amendment any of the securities being registered which remain unsold at the termination of the offering.

- (4) To file a post-effective amendment to the registration statement to include any financial statements required by Item 8.A of Form 20-F at the start of any delayed offering or throughout a continuous offering.

Insofar as indemnification for liabilities arising under the Securities Act of 1933 may be permitted to directors, officers and controlling persons of the registrant pursuant to the foregoing provisions, or otherwise, the registrant has been advised that in the opinion of the SEC such indemnification is against public policy as expressed in the Act and is, therefore, unenforceable. In the event that a claim for indemnification against such liabilities (other than the payment by the registrant of expenses incurred or paid by a director, officer or controlling person of the registrant in the successful defense of any action, suit or proceeding) is asserted by such director, officer or controlling person in connection with the securities being registered, the registrant will, unless in the opinion of its counsel the matter has been settled by controlling precedent, submit to a court of appropriate jurisdiction the question whether such indemnification by it is against public policy as expressed in the Act and shall be governed by the final adjudication of such issue.

That, for the purpose of determining liability of the registrant under the Securities Act of 1933 to any purchaser in the initial distribution of the securities, the undersigned registrant undertakes that in a primary offering of securities of the undersigned registrant pursuant to this registration statement, regardless of the underwriting method used to sell the securities to the purchaser, if the securities are offered or sold to such purchaser by means of any of the following communications, the undersigned registrant will be a seller to the purchaser and will be considered to offer or sell such securities to such purchaser:

- any preliminary prospectus or prospectus of the undersigned registrant relating to the offering required to be filed pursuant to Rule 424;
- any free writing prospectus relating to the offering prepared by or on behalf of the undersigned registrant or used or referred to by the undersigned registrant;
- the portion of any other free writing prospectus relating to the offering containing material information about the undersigned registrant or its securities provided by or on behalf of the undersigned registrant; and
- any other communication that is an offer in the offering made by the undersigned registrant to the purchaser.

The undersigned registrant hereby undertakes as follows: that prior to any public reoffering of the securities registered hereunder through use of a prospectus which is a part of this registration statement, by any person or party who is deemed to be an underwriter within the meaning of Rule 145(c), the issuer undertakes that such reoffering prospectus shall contain the information called for by the applicable registration form with respect to re-offerings by persons who may be deemed underwriters, in addition to the information called for by the other items of the applicable form.

The registrant undertakes that every prospectus: (1) that is filed pursuant to the immediately preceding paragraph, or (2) that purports to meet the requirements of Section 10(a)(3) of the Act and is used in connection with an offering of securities subject to Rule 415, shall be filed as a part of an amendment to the registration statement and shall not be used until such amendment is effective, and that, for purposes of determining any liability under the Securities Act of 1933, each such post-effective amendment shall be deemed to be a new registration statement relating to the securities offered therein, and the offering of such securities at that time shall be deemed to be the initial bona fide offering thereof.

The undersigned registrant hereby undertakes to respond to requests for information that is incorporated by reference into the prospectus pursuant to Item 4, 10(b), 11, or 13 of this form, within one business day of receipt of such request, and to send the incorporated documents by first class mail or other equally prompt means. This includes information contained in documents filed subsequent to the effective date of the registration statement through the date of responding to the request.

The undersigned registrant hereby undertakes to supply by means of a post-effective amendment all information concerning a transaction, and the company being acquired involved therein, that was not the subject of and included in the registration statement when it became effective.

**SIGNATURES**

Pursuant to the requirements of the Securities Act of 1933, the registrant has duly caused this registration statement on Form F-4 to be signed on its behalf by the undersigned, thereunto duly authorized, in Beijing, PRC, on February 3, 2023.

**YishengBio Co., Ltd**

By: /s/ Zhang Yi

\_\_\_\_\_  
Name: Zhang Yi

Title: Director and Chairperson

**POWER OF ATTORNEY**

Pursuant to the requirements of the Securities Act, this Registration Statement has been signed by the following persons in the capacities and on the dates indicated.

Signature	Title	Date
<u>/s/ Yi Zhang</u> Yi Zhang	Director and Chairperson	February 3, 2023
<u>/s/ Hui Shao</u> Hui Shao	Director and Chief Executive Officer <i>(Principal Executive Officer)</i>	February 3, 2023
<u>*</u> Ajit Shetty	Independent Director	February 3, 2023
<u>*</u> Viren Mehta	Independent Director	February 3, 2023
<u>*</u> Stanley Yi Chang	Independent Director	February 3, 2023
<u>*</u> Chunyuan Wu	Chief Financial Officer <i>(Principal Financial and Accounting Officer)</i>	February 3, 2023
* By: <u>/s/ Yi Zhang</u> Name: Yi Zhang Attorney-in-fact		
<u>/s/ Hui Shao</u> Name: Hui Shao Attorney-in-fact		

**AUTHORIZED REPRESENTATIVE**

Pursuant to the requirement of the Securities Act of 1933, the undersigned, solely in his capacity as the duly authorized representative of YishengBio Co., Ltd, has signed this registration statement in the City of New York, New York, on February 3, 2023.

**COGENCY GLOBAL INC.**

Authorized U.S. Representative

By: /s/ COLLEEN A. DE VRIES

---

Name: Colleen A. De Vries  
Title: Senior Vice-President on behalf  
of Cogency Global Inc.

**CONSENT OF INDEPENDENT REGISTERED PUBLIC ACCOUNTING FIRM**

We hereby consent to the use in this Registration Statement on Amendment No. 3 to Form F-4 of our report dated March 31, 2022, relating to the financial statements of Summit Healthcare Acquisition Corp., which is contained in that Registration Statement. We also consent to the reference to us under the caption "Experts" in the Registration Statement.

/s/ WithumSmith+Brown, PC

New York, New York

February 3, 2023

---



• **MAIN OFFICE**  
133-10 39<sup>TH</sup> AVENUE  
FLUSHING, NY 11354  
TEL. (718) 445-6308  
FAX. (718) 445-6760

• **CALIFORNIA OFFICE**  
440 E HUNTINGTON DR.  
STE 300  
ARCADIA, CA 91006  
TEL. (626) 282-1630  
FAX. (626) 282-9726

• **BEIJING OFFICE**  
11/F NORTH TOWER  
BEIJING KERRY CENTRE  
1 GUANGHUA ROAD  
CHAoyANG DISTRICT  
BEIJING, 100020, PRC  
TEL. (86 10) 65997923  
FAX. (86 10) 65999100

**CONSENT OF INDEPENDENT REGISTERED PUBLIC ACCOUNTING FIRM**

We consent to the use in this Registration Statement on Form F-4 of YishengBio Co., Ltd. of our report dated September 28, 2022, relating to the consolidated financial statements of YishengBio Co., Ltd. and Subsidiaries for the years ended March 31, 2022 and 2021, which appear in this Registration Statement.

We also consent to the reference to us under the heading “Experts” in such Registration Statement.

/s/ Wei, Wei & Co., LLP

Flushing, New York  
February 3, 2023

---